

easYgen-3000XT Series

Manual | Genset Control



easYgen-3400XT-P2 / 3500XT-P2 / 3500XT-P2-LT

Release 2.15-0

Document ID: B37581, Revision L - Build 53480

Manual (original)

This is no translation but the original Technical Manual in English.

Designed in Germany and Poland.

Woodward GmbH

Handwerkstr. 29

70565 Stuttgart

Germany

Telephone: +49 (0) 711 789 54-510

Fax: +49 (0) 711 789 54-101

E-mail: marketing_pg@woodward.com

Internet: <https://www.woodward.com>

© 2023 Woodward GmbH. All rights reserved.

Brief Overview

The easYgen-3000XT series are control units for engine-generator system management applications.

The control units can be used in applications such as: co-generation, stand-by, AMF, peak shaving, import/export or distributed generation.

The easYgen-3000XT series is also applicable for islanded, island parallel, mains parallel and multiple unit mains parallel operations.

Scope of delivery

The following parts are included in the scope of delivery. Please check prior to the installation that all parts are present.



Fig. 1: Scope of delivery

- | | |
|---|--|
| A | Device easYgen-3400XT-P2 (sheet metal housing) or easYgen-3500XT-P2(-LT) genset control (plastic housing). All screwable terminal connectors are delivered with plug and jack. |
| B | IPS (Installation Procedure Supplement) and printed QR Code sticker - 2 x |
| C | Clamp fastener installation material - 4 x (only plastic housing) |
| D | Screw kit installation material - 12 x (only plastic housing) |



Configuration files and Technical Manual are available on device internal memory. Opening USB connection to the easYgen-XT offers read access to the files listed below but with status "delivery" -- please be aware that this files are not updated. The latest versions are available at the Woodward web site.

Files stored at easYgen-XT device:

- Configuration
 - msi-file (installing application files and ToolKit)
 - eds-file (zipped)
- Technical Manual (PDF)

QR Code



To get access to the complete product documentation, scan this QR code or use the following link: ⇒ <http://wwdmanuals.com/easygen-3500xt-p2>.

Sample application setup

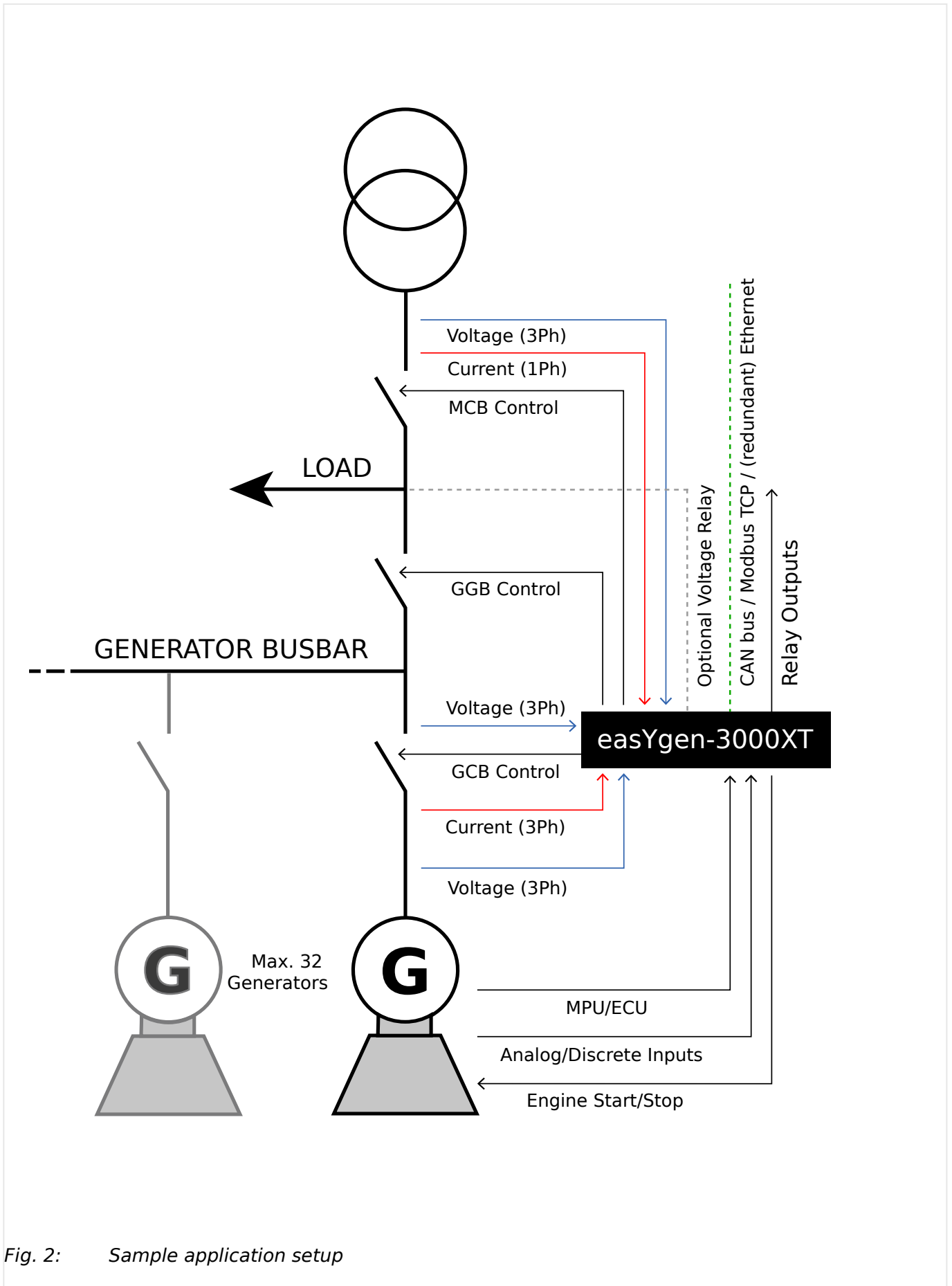

Fig. 2: Sample application setup

A typical application mode for the control unit is the use for mains parallel operation in a multi genset application.

- In this case, the easYgens-XT will function as an engine control with generator, mains and engine protection.
- The control unit can open and close the generator circuit breaker (GCB), group generator breaker (GGB), and the mains circuit breaker (MCB).
- The easYgens-XT are well prepared for system control and management, "talking" with other easYgens-3100XT/3200XT, easYgens-3400XT/3500XT and/or LS-5s and/or Group Controller (GC).

Note: Unless otherwise noted, "LS-5", "LSx", "LS -6XT" and "easYgen|LS-6XT" are used interchangeably in this document.



For a listing of all available application modes please refer to [↪ "6 Application Field"](#).

Table of Contents

1	General Information	28
1.1	Revision History	28
1.2	Depiction Of Notes And Instructions	43
1.2.1	Copyright And Disclaimer	44
1.2.2	Service And Warranty	45
1.3	Safety	45
1.3.1	Personnel	45
1.3.2	General Safety Notes	46
1.3.3	Protective Equipment And Tools	50
1.3.4	Intended Use	50
2	System Overview	52
2.1	Display And Status Indicators	52
2.1.1	HMI: Display and Buttons	53
2.1.2	LEDs Indicate State of Metal Housing Variant	59
2.2	Application Modes Overview	60
2.3	Operation Modes	63
3	Installation	65
3.1	Mount Unit (Sheet Metal Housing)	65
3.2	Mount Unit (Plastic Housing)	67
3.2.1	Clamp Fastener Installation	68
3.2.2	Screw Kit Installation	70
3.3	Setup Connections	72
3.3.1	Terminal Allocation	73
3.3.2	Wiring Diagram	75
3.3.3	Power Supply	80
3.3.4	Charging Alternator	82
3.3.5	Voltage Measuring	82
3.3.5.1	Generator Voltage	83
3.3.5.1.1	Parameter Setting '3Ph 4W OD' (3-phase, 4-wire, Open delta)	83
3.3.5.1.2	Parameter Setting '3Ph 4W' (3-phase, 4-wire)	85

- 3.3.5.1.3 Parameter Setting '3Ph 3W' (3-phase, 3-wire) 86
- 3.3.5.1.4 Parameter Setting '1Ph 3W' (1-phase, 3-wire) 87
- 3.3.5.1.5 Parameter Setting '1Ph 2W' (1-phase, 2-wire) 88
- 3.3.5.2 Mains Voltage 90
- 3.3.5.2.1 Parameter Setting '3Ph 4W' (3-phase, 4-wire) 91
- 3.3.5.2.2 Parameter Setting '3Ph 3W' (3-phase, 3-wire) 92
- 3.3.5.2.3 Parameter Setting '1Ph 3W' (1-phase, 3-wire) 94
- 3.3.5.2.4 Parameter Setting '1Ph 2W' (1-phase, 2-wire) 95
- 3.3.5.3 Busbar Voltage 97
- 3.3.5.3.1 Parameter Setting '3Ph 4W' (3-phase, 4-wire) 98
- 3.3.5.3.2 Parameter Setting '3Ph 3W' (3-phase, 3-wire) 99
- 3.3.5.3.3 Parameter Setting '1Ph 3W' (1-phase, 3-wire) 101
- 3.3.5.3.4 Parameter Setting '1Ph 2W' (1-phase, 2-wire) 102
- 3.3.6 Current Measuring 104
- 3.3.6.1 Generator Current 104
- 3.3.6.1.1 Parameter Setting 'L1 L2 L3' 106
- 3.3.6.1.2 Parameter Setting 'Phase L1' 'Phase L2' 'Phase L3' 106
- 3.3.6.2 Mains Current 107
- 3.3.6.2.1 Parameter Setting 'Phase L1' 'Phase L2' 'Phase L3' 108
- 3.3.6.3 Ground Current 109
- 3.3.7 Power Measuring 110
- 3.3.8 Power Factor Definition 111
- 3.3.9 Magnetic Pickup Unit (MPU) 112
- 3.3.10 Discrete Inputs 114
- 3.3.11 Relay Outputs (LogicsManager) 117
- 3.3.11.1 Connecting 24 V Relays 119
- 3.3.12 Analog Inputs 121
- 3.3.12.1 Analog Inputs (0 to 2000 Ohm | 0/4 to 20 mA | 0 to 1 V) 121
- 3.3.12.2 Analog Inputs (0/4 to 20 mA | 0 to 10 V) 123
- 3.3.12.3 Analog Inputs (0 to 250 Ohms | 0 to 2500 Ohms) 125
- 3.3.13 Analog Outputs 127
- 3.3.13.1 Analog Outputs (± 20 mA, ± 10 V, PWM) 127

3.3.13.2	Analog Outputs 3 to 6 (0/4 to 20 mA)	128
3.3.14	Transistor Outputs	129
3.4	Setup Interfaces	130
3.4.1	Interfaces overview	130
3.4.2	RS-485 Interface	131
3.4.3	USB (2.0 slave) interface - Service Port	133
3.4.4	CAN Bus Interfaces	134
3.4.5	Ethernet Interface (incl. Remote Panel)	137
4	Configuration	141
4.1	Front Panel Access	143
4.1.1	Basic Navigation	144
4.1.2	The HOME Screen	148
4.1.3	Customer Screens	151
4.1.4	Standard Menu Screens	153
4.1.4.1	Navigation Screens	153
4.1.4.2	Value Setting Screens	154
4.1.4.3	Status/Monitoring Screens	155
4.1.5	Specialized Menu Screens	156
4.1.5.1	HOME Screen Voltage Display	156
4.1.5.2	Alarm List	157
4.1.5.3	Event History	158
4.1.5.4	Sequencing	159
4.1.5.5	States easYgen	160
4.1.5.6	States LSx	161
4.1.5.7	Genset parameter alignment	162
4.1.5.8	Diagnostic devices	162
4.1.5.9	Setpoints generator	163
4.1.5.10	Setpoints PID1 - PID3	165
4.1.5.11	Synchroscope busbar/mains	167
4.1.5.12	LogicsManager Conditions	168
4.1.5.13	LogicsManager	169
4.1.5.14	Mains decoupling threshold	170

4.1.5.15	Test mains decoupling (VDE AR-N 4105)	171
4.1.5.16	CAN 1 state	173
4.1.5.17	CAN interface 2 state	174
4.1.5.18	CAN 3 state	177
4.1.5.19	Ethernet Network	179
4.1.5.20	USB	182
4.1.5.21	RS-485	183
4.1.5.22	J1939 Special	183
4.1.5.23	J1939 Status miscellaneous	184
4.1.5.24	Time Indication According To Operating Condition	186
4.2	Access Via PC (ToolKit)	187
4.3	Basic Setup	188
4.3.1	Configure Language/Clock	188
4.3.2	Configure HMI	194
4.3.2.1	Configure Customer Screens	194
4.3.2.2	Configure Display	197
4.3.2.3	Screen configuration	199
4.3.3	Lamp Test	201
4.3.4	Enter Password	201
4.3.4.1	Password System - Parameter Overview	216
4.3.4.1.1	Random Number for Password	217
4.3.4.1.2	Change/Reset Alphanumeric Password	217
4.3.5	System Management	220
4.3.5.1	Reboot Function	222
4.3.6	Configure Remote Panel Mode	223
4.3.6.1	Configuration screen Remote Panel Mode	223
4.3.6.2	General notes	223
4.3.6.3	RP-3000XT in Full Mode with Password suppression	224
4.3.6.4	RP-3000XT in Full Mode	225
4.3.6.5	RP-3000XT in Annunciator Mode	226
4.3.6.6	RP-3000XT in Off Mode	227
4.3.6.7	Parameters of RP Modes	228

4.4	Configure Application	229
4.4.1	Configure Engine	229
4.4.1.1	Configure Engine (general)	229
4.4.1.2	Engine Start/Stop	237
4.4.1.3	Magnetic Pickup Unit	250
4.4.1.4	Idle Mode	252
4.4.2	Inputs And Outputs	254
4.4.2.1	Function Of Inputs And Outputs	254
4.4.2.1.1	Discrete Inputs	254
4.4.2.1.2	Discrete Outputs	256
4.4.2.2	Discrete Inputs	260
4.4.2.3	Discrete Outputs (LogicsManager)	265
4.4.2.4	Analog Inputs	268
4.4.2.4.1	Analog Inputs (general)	268
4.4.2.4.2	Analog Inputs 1 to 3 (0 to 2000 Ω 0/4 to 20 m A 0 to 1 V)	271
4.4.2.4.3	Analog Inputs 4 to 6 (0 to 10 V 0/4 to 20 mA)	278
4.4.2.4.4	Analog Inputs 7 to 10 (0 to 250 Ω 0 to 2500 Ω)	283
4.4.2.5	Analog Outputs	288
4.4.2.5.1	Analog Outputs 1 and 2	288
4.4.2.5.2	Analog Outputs 3 to 6	293
4.4.2.6	External Analog Inputs	294
4.4.2.7	External Analog Outputs	298
4.4.2.8	External Discrete Inputs	301
4.4.2.9	External Discrete Outputs	302
4.4.3	Configure Breakers	303
4.4.3.1	Good to know: Actions with Breakers	304
4.4.3.1.1	Dead Bus Closing GCB	304
4.4.3.1.2	Synchronization GCB/MCB	306
4.4.3.1.3	Dead Bus Closing MCB	307
4.4.3.1.4	Open GCB	308
4.4.3.1.5	Open MCB	309
4.4.3.1.6	Transition Modes (Breaker Logic)	309

- 4.4.3.1.7 GGB Handling 314
- 4.4.3.2 General Breaker Settings 315
- 4.4.3.3 Configure Breakers: GCB 321
- 4.4.3.4 Configure Breakers: GGB 329
- 4.4.3.5 Configure Breakers: MCB 334
- 4.4.3.6 Configure Breakers: Synchronization 340
- 4.4.3.6.1 Independent Sync. Check Function 342
- 4.4.3.7 Configure Breakers: Neutral Interlocking 344
- 4.4.4 Configure Controller 345
- 4.4.4.1 Voltage Control 347
- 4.4.4.1.1 AVR 354
- 4.4.4.2 Power Factor Control 362
- 4.4.4.2.1 Control The Power Factor / Reactive Power At The Mains Interchange Point 362
- 4.4.4.2.2 Configure Power Factor / kvar Control 364
- 4.4.4.2.3 AVR FRT Adjustments 370
- 4.4.4.2.4 Power Factor Characteristic 372
- 4.4.4.2.5 Reactive Power / Power Factor setpoint filter 376
- 4.4.4.2.6 Reactive Power Characteristic 378
- 4.4.4.3 Load Share Control 388
- 4.4.4.3.1 Mains Parallel Operation With Mains Interchange Real Power Control (Import/Export) 389
- 4.4.4.3.2 Islanded Operation In Parallel 389
- 4.4.4.3.3 Re-synchronization Of The Busbar To The Mains 390
- 4.4.4.3.4 Prerequisites 391
- 4.4.4.3.5 Load-Share Interface 391
- 4.4.4.3.6 Load Sharing 391
- 4.4.4.3.7 Parameters 393
- 4.4.4.3.8 Load Share Control Grouping 395
- 4.4.4.3.9 Segment Number in GCB/LSx mode 398
- 4.4.4.3.10 Droop 400
- 4.4.4.4 Frequency Control 403
- 4.4.4.5 Load Control 413
- 4.4.4.5.1 Configure: Load Control (general) 413

4.4.4.5.2	Configure: Load Setpoints	419
4.4.4.5.3	Configure: Warm-up	423
4.4.4.5.4	Derating And Uprating Of Power	424
4.4.4.5.5	Active Power – Frequency Function P(f)	428
4.4.4.6	PID {x} Control	434
4.4.4.7	Discrete Raise/Low Function	437
4.4.4.8	Configure PV load reference	439
4.4.4.8.1	Photovoltaic (PV) load reduction regulated mode	440
4.4.4.8.2	Photovoltaic (PV) load reduction calculated mode	444
4.4.5	Configure Operation Modes	447
4.4.5.1	Operation Modes: General	447
4.4.5.2	Operation Mode AUTO - Automatic Run	449
4.4.5.3	Operation Mode TEST	451
4.4.5.4	Critical Mode	453
4.4.5.4.1	Critical Operation At Busbar	454
4.4.5.4.2	Critical Operation At The Generator	457
4.4.5.4.3	Parameters	459
4.4.5.5	Load Dependent Start/Stop (LDSS)	460
4.4.5.5.1	Generator Load	460
4.4.5.5.2	System Reserve Power	462
4.4.5.5.3	Generator Selection	464
4.4.5.5.4	Islanded Parallel Operation (IOP)	471
4.4.5.5.5	Mains Parallel Operation	477
4.4.5.5.6	LDSS with predicted load	482
4.4.6	Emergency Run	485
4.5	Configure Monitoring	489
4.5.1	Configure Generator Monitoring	489
4.5.1.1	Generator Operating Ranges: Voltage / Frequency / Busbar	489
4.5.1.2	Generator Voltage Monitoring	491
4.5.1.2.1	Generator Overvoltage (Level 1 & 2) ANSI# 59	492
4.5.1.2.2	Generator Undervoltage (Level 1 & 2) ANSI# 27	493
4.5.1.2.3	Generator Voltage Asymmetry	495

- 4.5.1.3 Generator Frequency Monitoring 497
- 4.5.1.3.1 Plausibility Check of Voltages' AC Wiring 497
- 4.5.1.3.2 Generator Overfrequency (Level 1 & 2) ANSI# 810 498
- 4.5.1.3.3 Generator Underfrequency (Level 1 & 2) ANSI# 810 500
- 4.5.1.4 Generator Current Monitoring 502
- 4.5.1.4.1 Generator Time-Overcurrent (Level 1, 2 & 3) ANSI# 50/51 502
- 4.5.1.4.2 Generator Inverse Time-Overcurrent ANSI# IEC 255 504
- 4.5.1.4.3 Generator Voltage Restrained Overcurrent Monitoring - ANSI #51V 508
- 4.5.1.5 Generator Power Monitoring 510
- 4.5.1.5.1 Generator Overload IOP (Level 1 & 2) ANSI# 32 510
- 4.5.1.5.2 Generator Overload MOP (Level 1 & 2) ANSI# 32 512
- 4.5.1.5.3 Generator Reverse/Reduced Power (Level 1 & 2) ANSI# 32R/F 514
- 4.5.1.5.4 Generator Unbalanced Load (Level 1 & 2) ANSI# 46 516
- 4.5.1.5.5 Load sharing 519
- 4.5.1.5.6 Engine/Generator Active Power Mismatch 522
- 4.5.1.5.7 Engine/Generator Unloading Mismatch 523
- 4.5.1.6 Other Monitoring 524
- 4.5.1.6.1 Power Factor - configure generator power factor monitoring 524
- 4.5.1.6.2 Miscellaneous 529
- 4.5.1.6.3 Pole Slip Monitoring 537
- 4.5.2 Configure Engine Monitor 540
- 4.5.2.1 Engine Overspeed (Level 1 & 2) ANSI# 12 540
- 4.5.2.2 Engine Underspeed (Level 1 & 2) 541
- 4.5.2.3 Engine/Generator Speed Detection 543
- 4.5.2.4 Engine Start Failure 545
- 4.5.2.5 Engine Shutdown Malfunction 546
- 4.5.2.6 Engine Unintended Stop 547
- 4.5.2.7 Engine Charge Alternator (D+) 548
- 4.5.2.8 Cylinder Temperature 549
- 4.5.3 Mains 556
- 4.5.3.1 General Mains Monitoring 556
- 4.5.3.2 Blocking of Mains Protection 557

4.5.3.3	Mains Operating Ranges	558
4.5.3.3.1	General Mains Operating Range	558
4.5.3.3.2	Reconnecting Mains Operating Range	560
4.5.3.4	Mains Decoupling	561
4.5.3.4.1	Setup Grid Code AR--4105	565
4.5.3.4.2	Setup Grid Code BDEW (medium voltage guideline)	570
4.5.3.5	Mains Overfrequency (Level 1 & 2) ANSI# 81O	571
4.5.3.6	Mains Underfrequency (Level 1 & 2) ANSI# 81U	573
4.5.3.7	Mains Overvoltage (Level 1 & 2) ANSI# 59	575
4.5.3.8	Mains Undervoltage (Level 1 & 2) ANSI# 27	577
4.5.3.9	Mains Voltage Increase	579
4.5.3.10	Mains Time-Dependent Voltage	581
4.5.3.10.1	Time Dependent Mains Voltage Monitor 1	583
4.5.3.10.2	Time Dependent Mains Voltage Monitor 2	587
4.5.3.10.3	Time Dependent Mains Voltage Monitor 3	589
4.5.3.10.4	Time dependent voltage monitoring – Decoupling Function	592
4.5.3.11	QV Monitoring	592
4.5.3.12	Change Of Frequency	595
4.5.3.13	Mains Voltage Phase Rotation	600
4.5.3.14	Mains Import Power (Level 1 & 2)	602
4.5.3.15	Mains Export Power (Level 1 & 2)	604
4.5.3.16	Engine/Mains Active Power Mismatch	605
4.5.3.17	Mains Lagging Power Factor (Level 1 & 2)	607
4.5.3.18	Mains Leading Power Factor (Level 1 & 2)	609
4.5.4	Breaker	611
4.5.4.1	Configure GCB	611
4.5.4.2	Configure GCB 50BF	613
4.5.4.3	Synchronization GCB	614
4.5.4.4	Configure GGB	615
4.5.4.5	Synchronization GGB	616
4.5.4.6	Configure MCB	617
4.5.4.7	Synchronization MCB	619

4.5.4.8	Configure MCB 50BF	620
4.5.4.9	MCB plausibility	621
4.5.4.10	Configure Neutral Contactor	622
4.5.5	Flexible Limits	623
4.5.6	Miscellaneous	629
4.5.6.1	General monitoring settings	629
4.5.6.2	Free Configurable Alarms	631
4.5.6.3	CAN Interfaces	633
4.5.6.4	CAN Interface 1	633
4.5.6.5	CAN Interface 2	635
4.5.6.6	CAN Interface 3	637
4.5.6.7	CAN Interface 2 - J1939 Interface	639
4.5.6.8	J1939 Interface - Red (Stop) Alarm	645
4.5.6.9	J1939 Interface - Amber Warning Alarm	646
4.5.6.10	J1939 Interface - Protect Alarm	647
4.5.6.11	J1939 Interface - Emission/Malfunction Alarm	648
4.5.6.12	J1939 Interface - DM1 Alarms	650
4.5.6.13	Ethernet interfaces	651
4.5.6.14	Battery Overvoltage (Level 1 & 2)	652
4.5.6.15	Battery Undervoltage (Level 1 & 2)	653
4.5.6.16	Monitoring PV load reference	655
4.5.6.17	Multi-Unit Parameter Alignment	656
4.5.6.18	Multi-Unit Missing easYgen	658
4.5.6.19	Multi-Unit Missing LSx	660
4.5.6.20	Multi-Unit System Update	661
4.5.6.21	Operating Range Failure	662
4.5.6.22	Load Share Interface Redundancy is Lost	664
4.6	Configure Measurement	665
4.6.1	General measurement settings	666
4.6.2	Generator	668
4.6.2.1	Configure transformer	671
4.6.3	Busbar	673

4.6.3.1	Configure transformer	675
4.6.4	Mains	675
4.6.4.1	Configure transformer	678
4.6.4.2	External Mains Active Power	679
4.6.4.3	External Mains Reactive Power	680
4.6.5	Engine	681
4.7	Configure Interfaces	682
4.7.1	USB (Service Port) Interface	682
4.7.2	RS-485 Interface	683
4.7.3	Modbus Protocol	684
4.7.4	CAN Interfaces	687
4.7.4.1	CAN Interface 1	687
4.7.4.1.1	Additional Server SDOs (Service Data Objects)	691
4.7.4.1.2	Receive PDO {x} (Process Data Object)	692
4.7.4.1.3	Transmit PDO {x} (Process Data Object)	695
4.7.4.2	CAN Interface 2	700
4.7.4.2.1	Expansion Modules at CANopen Interface	701
4.7.4.2.2	J1939 Interface	711
4.7.4.3	CAN Interface 3	725
4.7.4.3.1	Receive PDO {x} (Process Data Object)	728
4.7.4.3.2	Transmit PDO {x} (Process Data Object)	732
4.7.4.4	CAN Load Share Parameters	737
4.7.5	Ethernet Interfaces	738
4.7.5.1	General notes “Network address”	739
4.7.5.2	Ethernet Network A	741
4.7.5.3	Ethernet Network B	743
4.7.5.4	Ethernet Network C	744
4.7.5.5	SNTP	745
4.7.5.6	Ethernet Interconnectivity	746
4.8	Configure LogicsManager	748
4.8.1	Configure Internal Flags	748
4.8.2	Configure LSx	750

4.8.3	Set Timers	752
4.8.4	Lamp Test	757
4.9	Configure AnalogManager	757
4.9.1	Operations	757
4.9.2	AnalogManager Constants	770
4.10	Configure Counters	771
4.10.1	Generator Preset Values	771
4.10.2	Service Reset Values	772
4.10.3	Counter Pulses and Transistor Output	776
5	Operation	779
5.1	Power ON	779
5.2	Change Operating Modes	780
5.2.1	Operating Mode STOP	781
5.2.2	Operating Mode MANUAL	782
5.2.3	Operating Mode AUTOMATIC	784
5.2.4	Operating Mode TEST	786
5.3	Restore Language Setting via HMI, Buttons and Softkeys	787
6	Application Field	788
6.1	Basic Applications	788
6.1.1	Application mode A01 (None)	788
6.1.2	Application mode A02 (GCB open)	789
6.1.3	Application mode A03 (GCB)	791
6.1.4	Application mode A04 (GCB/MCB)	793
6.1.5	Application mode A05 (GCB/GGB)	795
6.1.6	Application mode A06 (GCB/GGB/MCB)	797
6.1.7	Application mode A07 (GCB/LSx)	800
6.1.8	Application mode A08 (GCB/L-MCB)	802
6.1.9	Application mode A09 (GCB/GGB/L-MCB)	804
6.1.10	Application mode A10 (GCB/L-GGB)	807
6.1.11	Application mode A11 (GCB/L-GGB/L-MCB)	809
6.1.12	Application mode A12 (GCB/L-GGBMCB)	812
6.1.13	Application mode A13 (GCB/GC)	815

6.1.13.1	Introduction	815
6.1.13.2	Application mode A13 (GCB/GC) with GC-application mode GGB/MCB	816
6.2	Multiple Genset Applications	818
6.2.1	Configuration Example: Multiple Genset	819
6.2.1.1	Configuring Load-Dependent Start/Stop	820
6.2.1.2	Configuring Automatic Operation	823
6.2.1.3	Configuring Emergency Operation	824
6.2.1.4	Configuring Power Control	825
6.2.2	Communication Management	825
6.2.2.1	System Update	825
6.2.2.2	Diagnostic Screens	827
6.2.2.3	Practicing the System Update Functionality	833
6.2.2.4	Tips for commissioning load share communication via Ethernet	834
6.2.3	Ethernet Interconnectivity	836
6.2.3.1	Configuration	838
6.2.4	Ethernet Communication - General Measures to optimize bus load on easYgen devices	840
6.2.4.1	General	840
6.2.4.2	CPU System Load as Indicator	840
6.2.4.3	What can be done to reduce Ethernet communication load	841
6.2.4.4	Ethernet Load - Application Examples	841
6.2.4.5	Recommendations for Software releases before 2.15	842
6.3	Special Applications	843
6.3.1	Generator Excitation Protection	843
6.3.2	Configuring A Setpoint Control Via Analog Input	845
6.3.3	Creating Self-Toggling (Pulsing) Relays	848
6.3.4	Changing A Starter Battery Set	849
6.3.5	Performing Remote Start/Stop And Acknowledgment	851
6.3.5.1	Operating Modes	852
6.3.5.2	Setting Up A Test With Or Without Load	853
6.3.5.3	Remote Start/Stop, Shutdown, And Acknowledgment	855
6.3.6	Connecting IKD 1, IKD-IN-16 and IKD-OUT-16 on CAN Bus	859
6.3.6.1	Configuration for the first IKD 1	860

- 6.3.6.2 IKD Configuration Tool 862
- 6.3.6.3 Configuration for a second IKD 1 865
- 6.3.7 Connecting easYlite-200 on CAN Bus 866
- 6.3.8 Configuring A PWM Duty Cycle For A CAT ADEM Controller 871
- 6.3.9 Wiring Self Powered Discrete Inputs 873
- 6.3.10 Connecting Analog Inputs In Series 873
- 6.3.11 Setup Expansion Modules at CAN 2 874
- 6.3.12 Phase Angle Compensation 883
- 6.3.13 Start/Stop Logic Mode "Off" 887
- 6.3.14 Ripple Control Receiver 891
- 6.3.15 Neutral Interlocking 895
- 6.3.16 Run-Up Synchronization 898
 - 6.3.16.1 Configuration 901
 - 6.3.16.2 Procedures 903
 - 6.3.16.2.1 Application Mode GCB 903
 - 6.3.16.2.2 Application Mode GCB/GGB 905
 - 6.3.16.2.3 Application Mode GCB/MCB 907
 - 6.3.16.2.4 Run-Up Synchronization without Speed Sensor 908
 - 6.3.16.2.5 Application Mode GCB/GGB/MCB 911
 - 6.3.16.3 Parameter Information 913
 - 6.3.16.4 Commissioning Checklist 914
- 6.3.17 LDSS with predicted load 916
 - 6.3.17.1 Introduction 916
 - 6.3.17.2 Internal source mode (EG3500XT only) 917
 - 6.3.17.2.1 General 917
 - 6.3.17.2.2 Example "Emergency power unit" with internal GGB control (only easYgen 3400XT/3500XT) 919
 - 6.3.17.3 External source mode 921
 - 6.3.17.3.1 General 921
 - 6.3.17.3.2 LDSS PL CANopen Handling 923
 - 6.3.17.3.3 Internally provided analog variables 925
 - 6.3.17.4 Tables 926
- 6.3.18 Derating And Uprating Of Power (Details) 927

6.3.18.1	Direct Derating	927
6.3.18.2	Derating With Characteristic Curve	928
6.3.18.3	J1939 (ECU) Derating	932
6.3.19	Examples timer configuration	932
6.3.20	LDSS with Interchange, Closed Transit. or Open Transition	933
6.3.20.1	LDSS for main parallel-/ isolated operation	934
6.3.20.2	LDSS only for isolated operation	935
6.4	CANopen Applications	936
6.4.1	Remote Control	936
6.4.1.1	Remote Start/Stop, Shutdown, And Acknowledgment	936
6.4.1.1.1	RPDO	937
6.4.1.1.2	Default SDO Communication Channel	938
6.4.1.2	Transmitting A Frequency Setpoint	941
6.4.1.2.1	RPDO	941
6.4.1.2.2	Default SDO Communication Channel	943
6.4.1.3	Transmitting A Voltage Setpoint	943
6.4.1.3.1	RPDO	944
6.4.1.3.2	Default SDO Communication Channel	945
6.4.1.4	Transmitting A Power Factor Setpoint	945
6.4.1.4.1	RPDO	946
6.4.1.4.2	Default SDO Communication Channel	947
6.4.1.5	Transmitting A Power Setpoint	948
6.4.1.5.1	RPDO	948
6.4.1.5.2	Default SDO Communication Channel	950
6.4.1.6	Transmitting Multiple Setpoints	950
6.4.1.7	Remotely Changing The Setpoint	951
6.4.1.7.1	RPDO	952
6.4.1.7.2	Default SDO Communication Channel	953
6.4.1.8	Transmitting A Remote Control Bit	954
6.4.1.8.1	Default SDO Communication Channel	955
6.4.2	Sending A Data Protocol via TPDO	956
6.4.3	Troubleshooting	957

6.5	Modbus Applications	958
6.5.1	Remote Control	958
6.5.1.1	Remote Start/Stop, Shutdown, And Acknowledgment	958
6.5.1.2	Setpoint Setting	961
6.5.1.3	Remotely Changing The Setpoint	965
6.5.2	Changing Parameter Settings	968
6.5.2.1	Parameter Setting	968
6.5.2.2	Configuration Of LogicsManager Functions	969
6.5.2.3	Configuration Of LogicsManager Functions For Remote Access	974
6.5.2.3.1	Basic remote control functions	974
6.5.2.3.2	Configuration of the LogicsManager "Operation mode AUTO"	974
6.5.2.3.3	Configuration Of Remote Start/Stop, Shutdown, And Acknowledgment	976
6.5.2.3.4	Configuration Of LogicsManager Function "Start Request in AUTO"	976
6.5.2.3.5	Configuration Of LogicsManager Function "External Acknowledge"	978
6.5.2.3.6	Configuration Of LogicsManager Function "Start w/o load"	979
6.5.2.4	Remotely Acknowledge Single Alarm Messages	981
6.5.2.5	Remotely Clearing The Event History	982
6.5.2.6	Remotely Resetting The Default Values	983
6.5.2.6.1	Modbus	983
6.5.3	Exception Responses	984
6.5.4	Modbus Telegram Mapper (Customer Written Data Protocols)	985
6.5.4.1	Introduction	985
6.5.4.2	Configuration	985
6.5.4.3	Status/diagnostic Modbus Telegram Mapper	986
6.5.5	Modbus master	987
6.5.5.1	Introduction	987
6.5.5.2	Configuration with MasterMapper Tool	988
6.5.5.3	Status/diagnostic Modbus master	989
7	Interfaces And Protocols	993
7.1	CAN Interfaces	993
7.1.1	CAN Interface 1 (Guidance level)	993
7.1.2	CAN Interface 2 (Engine level)	993

7.1.3	CAN Interface 3 (System level)	994
7.2	Ethernet Interfaces	995
7.3	Serial Interfaces	997
7.3.1	RS-485 Interface (Serial Interface 2)	997
7.3.2	USB interface (USB 2.0, slave)	997
7.4	CANopen Protocol	997
7.5	J1939 Protocol	999
7.5.1	Displayed Messages (Visualization)	1000
7.5.2	Supported J1939 ECUs & Remote Control Messages	1008
7.5.3	Device Types "Standard" and "Standard C"	1013
7.6	Modbus Protocol	1015
7.7	Load Sharing	1018
7.7.1	Load Share via CAN	1021
7.7.2	Load Share via UDP Broadcast Messages (Ethernet)	1022
8	Technical Specifications	1023
8.1	Technical Data	1023
8.1.1	Measuring Values	1024
8.1.2	Ambient Variables	1025
8.1.3	Inputs/Outputs	1025
8.1.4	Interfaces	1028
8.1.5	Real Time Clock Battery	1030
8.1.6	Display (plastic housing variant, only)	1030
8.1.7	Housing	1030
8.1.8	Approvals	1031
8.2	Environmental Data	1031
8.3	Accuracy	1032
8.4	Protection (ANSI)	1035
9	Appendix	1036
9.1	Characteristics	1036
9.1.1	Triggering Characteristics	1036
9.1.2	VDO Inputs Characteristics	1041
9.1.2.1	VDO Input "Pressure"	1042

9.1.2.2	VDO Input "Temperature"	1044
9.1.2.3	Pt100 RTD	1047
9.1.2.4	Pt1000 RTD	1048
9.1.2.5	NTC-Sender "AB_94099" (AB-Elektronik Sachsen GmbH)	1049
9.2	Data Protocols	1049
9.2.1	Protocol 5003 (Basic Visualization)	1050
9.2.2	Protocol 5004 (Generator Values Visualization)	1076
9.2.3	Protocol 5005 (Mains Values Visualization)	1082
9.2.4	Protocol 5010 (Basic Visualization)	1083
9.2.5	Protocol 5011 (Alarm Values Visualization)	1121
9.2.6	Protocol 5014 (Based on Protocol 5003 but with enhancements)	1140
9.2.7	Protocol 5016 (Basic Visualization)	1165
9.2.8	Protocol 5017 (Alarm Values Visualization)	1221
9.2.9	Additional Data Identifier	1242
9.2.9.1	Receive Data (sent from remote control to the easYgen)	1242
9.2.9.2	Transmit Data (sent from easYgen to control external devices)	1250
9.2.9.3	Data Receive (interconnectivity)	1252
9.2.9.3.1	Introduction	1252
9.2.9.3.2	Analog variables CAN1 RPDO	1252
9.2.9.3.3	Command variables CAN 1 RPDO	1253
9.2.9.3.4	Free Analog Values	1256
9.2.9.4	Data Identifiers in General	1257
9.3	LogicsManager Reference	1260
9.3.1	LogicsManager Overview	1260
9.3.2	Logical Command Variables	1263
9.3.2.1	Group 01: Global alarms	1263
9.3.2.2	Group 02: System conditions	1263
9.3.2.3	Group 03: Engine control	1266
9.3.2.4	Group 04: Application conditions	1269
9.3.2.5	Group 05: Engine related alarms	1272
9.3.2.6	Group 06: Generator related alarms	1272
9.3.2.7	Group 07: Mains related alarms	1273

9.3.2.8	Group 08: Syst. related alarms	1275
9.3.2.9	Group 09: Alarms discrete inputs	1277
9.3.2.10	Group 10: Alarms analog inputs	1278
9.3.2.11	Group 11: Clock and timer	1278
9.3.2.12	Group 12: External discrete inputs	1279
9.3.2.13	Group 13: Discrete outputs (physical state)	1280
9.3.2.14	Group 14 Engine control 2	1281
9.3.2.15	Group 15: Flexible limits	1283
9.3.2.16	Group 16: Free alarms latched	1284
9.3.2.17	Group 17: System alarms	1285
9.3.2.18	Group 18: Buttons	1285
9.3.2.19	Group 22: GC alarm flags	1286
9.3.2.20	Group 25: External analog inputs out of range	1287
9.3.2.21	Group 26: Flags from LSx 33-48 (Layer 1)	1288
9.3.2.22	Group 27: Flags from LSx 49-64 (Layer 1)	1290
9.3.2.23	Group 28: LSx System conditions (Layer 1)	1292
9.3.2.24	Group 31: Pulse signals	1293
9.3.2.25	Group 32: CAN1 Receive PDO1	1293
9.3.2.26	Group 33: CAN1 Receive PDO2	1293
9.3.2.27	Group 34: CAN1 Receive PDO3	1294
9.3.2.28	Group 35: CAN1 Receive PDO4	1294
9.3.2.29	Group 36: CAN1 Receive PDO5	1295
9.3.2.30	Group 54: Modbus Master flags	1296
9.3.2.31	Group 81: AnalogManager boolean results 1	1298
9.3.2.32	Group 82: AnalogManager boolean results 2 (Flexible Limits)	1300
9.3.2.33	Group 86: LM Results 1	1301
9.3.2.34	Group 87: LM Results 2	1302
9.3.2.35	Group 88: LM Results 3 (Free alarms)	1304
9.3.2.36	Group 90: AnalogManager Internal values 0 (Customer screens)	1305
9.3.2.37	Group 91: AnalogManager Internal values 1	1305
9.3.2.38	Group 93: AnalogManager Analog outputs 1	1306
9.3.2.39	Group 96: LM Internal flags 1	1306

- 9.3.2.40 Group 98: LM External DOs 1 1307
- 9.3.2.41 Group 99: LM Internal DOs 1 1308
- 9.3.3 Logical Symbols 1309
- 9.3.4 Logical Outputs 1310
- 9.3.5 Factory Settings 1322
- 9.4 AnalogManager Reference 1331
- 9.4.1 AnalogManager Overview 1331
- 9.4.2 Data Sources AM 1332
- 9.4.2.1 Group 01: Generator values 1332
- 9.4.2.2 Group 02: Mains values 1334
- 9.4.2.3 Group 03: Busbar 1 values 1337
- 9.4.2.4 Group 05: Controller setpoints 1338
- 9.4.2.5 Group 06: DC analog inputs 1340
- 9.4.2.6 Group 07: J1939 values 1 1341
- 9.4.2.7 Group 08: External analog inputs 1343
- 9.4.2.8 Group 09: J1939 values 2 1344
- 9.4.2.9 Group 10: Internal values 1346
- 9.4.2.10 Group 11: Engine values 1347
- 9.4.2.11 Group 13: Constants 1348
- 9.4.2.12 Group 14: Controller values 1348
- 9.4.2.13 Group 15: Controller setpoints 2 1349
- 9.4.2.14 Group 16: Internal values 2 1349
- 9.4.2.15 Group 21: CAN1 Receive 1349
- 9.4.2.16 Group 24: Free analog values 1350
- 9.4.2.17 Group 54: Modbus Master pulled flags 1350
- 9.4.2.18 Group 81: Results 1 1353
- 9.4.2.19 Group 82: Results 2 1354
- 9.4.2.20 Group 90: Internal Values 0 1355
- 9.4.2.21 Group 91: Internal Values 1 1356
- 9.4.2.22 Group 93: Analog Outputs 1 1357
- 9.4.3 Factory Settings 1357
- 9.5 Status, Event And Alarm Reference 1370

9.5.1	Status messages	1370
9.5.2	Event History	1374
9.5.3	Event Message	1375
9.5.4	Alarm Classes	1376
9.5.5	Alarm Messages	1378
9.5.5.1	J1939 alarms	1378
9.5.5.2	No alarm	1378
9.5.5.3	Generator monitoring	1378
9.5.5.4	Busbar monitoring	1380
9.5.5.5	Mains monitoring	1380
9.5.5.6	Engine monitoring	1382
9.5.5.7	Operating Range Monitoring	1383
9.5.5.8	Breaker Monitoring	1386
9.5.5.9	CANopen Monitoring	1387
9.5.5.10	CAN J1939 (ECU) Monitoring	1387
9.5.5.11	Ethernet Communication Monitoring	1388
9.5.5.12	Multi-unit Monitoring	1388
9.5.5.13	Flexible Limits Monitoring	1389
9.5.5.14	Digital Inputs Monitoring	1390
9.5.5.15	External Digital Inputs Monitoring	1391
9.5.5.16	Wire Break Monitoring (of internal and external analog inputs)	1392
9.5.5.17	Free Configurable Alarms	1393
9.5.5.18	Miscellaneous Monitoring	1394
9.6	Formulas	1395
9.6.1	Conversion Factors	1395
9.6.2	Load Dependent Start Stop (LDSS) Formulas	1395
10	List Of Abbreviations	1398
11	Index	1401

1 General Information

1.1 Revision History

Rev.	Date	Editor	Changes
L	2023-09	LU	<p>NEW Software Revision Release 2.15-0 or higher</p> <p>NEW features & functions</p> <ul style="list-style-type: none"> • The AMF Emergency run can now open the MCB immediately (refer to ↪ 2839). • There is now a possibility to turn off the integral part of the frequency-/active power controller (refer to ↪ 5511, ↪ 5514). • Some measured values can be filtered: <ul style="list-style-type: none"> ◦ The Generator frequency measurement can be filtered (refer to ↪ 4554). ◦ The Generator power measurement can be filtered (refer to ↪ 1886). ◦ The Mains power measurement can be filtered (refer to ↪ 1882). ◦ The Generator voltage measurement can be filtered (refer to ↪ 4555). ◦ The Generator reactive power measurement can be filtered (refer to ↪ 4559). ◦ The speed input measurement can be filtered (refer to ↪ 1605). • Some ToolKit improvements: <ul style="list-style-type: none"> ◦ Each internal LogicsManager flag provides a configurable description. ◦ Each AnalogManager result variable and result flag is indicated near to the AM in ToolKit. ◦ Providing of an overview page with all free LM internal flags and their descriptions, free AM internal analog values with their free AM internal flags with their descriptions. (Path: "PARAMETER"/"Configure L/A Manager"/"Overview L/A Manager") ◦ Slightly design changes in button colours and icons of the online diagram at the Homepage changed. • Introduction of the Ethernet Interconnectivity Function (refer to ↪ "4.7.5.6 Ethernet Interconnectivity"). • The number of free configurable alarms is increased from 16 to 32. • New GC (Group Controller) alarms are now available in the easYgen (refer to ↪ "9.3.2.19 Group 22: GC alarm flags"). • The remaining "Mains settling" time is indicated on HMI and ToolKit (refer to ↪ 2801). • All shutdown alarms can be delayed to realize a load shedding (refer to ↪ 2645). • The indication of active status messages on HMI and ToolKit is improved. If several states are present at the same time, they are displayed in a rolling display. <p>Additionally the states "Frequency droop" and "Voltage droop" are added.</p> <ul style="list-style-type: none"> • The sequencing page indicates now independent on LDSS activation the "Nominal power", the "Active power" and the "Reserve power" of the system. • The circuit-breaker replies can be configured as "normally closed" or "normally open". • The circuit-breaker replies handling can be configured as "normally closed" or "normally open". (refer to GCB ↪ 3474, GGB ↪ 3475, MCB ↪ 3476) • Introduction of 7 additional timers for general purposes like Start/Stop, pumps, prelube etc. ↪ "Timer weekly 1 - 7 settings" • Two annunciator easYlite-200 Modules (2 x 16 LEDs) are supported (refer to ↪ "6.3.7 Connecting easYlite-200 on CAN Bus"). • Introduction of the PV load reduction function based on power calculations (refer to ↪ "4.4.4.8.2 Photovoltaic (PV) load reduction calculated mode"). • New LogicsManager variables to show the state of the buttons on display devices (refer to ↪ "9.3.2.18 Group 18: Buttons" and ↪ Fig. 4). • Introduction of a LogicsManager for lamp test (refer to ↪ "4.3.3 Lamp Test"). • Introduction of new AnalogManager variables

Rev.	Date	Editor	Changes
			<ul style="list-style-type: none"> ◦ Generator reactive load in system (10.48 [%] and 10.98 [kvar]) (refer to ↪ "9.4.2.9 Group 10: Internal values") ◦ PV power setpoint (10.49 [%] and 10.99 [kW]) ◦ Load share average active power (16.01 [%]) (refer to ↪ "9.4.2.14 Group 16: Internal values 2") ◦ Load share average reactive power (16.02 [%]) ◦ Number of active load sharing generators (16.53) ◦ Number of reactive load sharing generators (16.54) ◦ Number of closed GCB in the same segment (16.55) ◦ PV Consumer load (16.56 [kW]) ◦ Generator total nominal active power in the system (16.57 [kW]) ◦ Generator total nominal reactive power in the system (16.58 [kvar]) ◦ Additionally some generator (01.88, 01.89, 01.90) and mains (02.91, 02.92, 02.93, 02.94) power values now available as analog variables in kW/kVA too (refer to ↪ "9.4.2.1 Group 01: Generator values" and ↪ "9.4.2.2 Group 02: Mains values"). <ul style="list-style-type: none"> • Free PID 1-3: The lowest value for the "Sampling time" is now 0.08 s. This makes the PID usable for biasing as analog output. It helps also to make the Three Position Controller more precise with pulse length (refer to ↪ "4.4.4.6 PID {x} Control"). <p>The "Deadband" of these PIDs is now adjustable with decimal points. This is useful if decimal values like frequency or power shall be controlled.</p> <ul style="list-style-type: none"> • It is possible to monitor the digital output terminals IKD-OUT-16 for timeouts (refer to ↪ 16206). • Maximum value of "Mains fail delay time" increased to 655 s. • Entry of "Load control setpoint maximum" now possible with one decimal place. • J1939: Introduction of parameter "Set addresses by Device type" which sets parameters "J1939 own address" and "Engine control address" according to the description of these parameters automatically (refer to ↪ 10454). • J1939: New SPNs (51, 1117 to 1119, 1127, 1695, 1696, 3237 to 3240, 3517, 4765, 4766) added (refer to ↪ "Standard visualization messages"). Most of them are related to exhaust gas aftertreatment. • J1939: New ECU Device type "FPT MD1" with corresponding logic variables added (refer to ↪ "Special FPT MD 1 flags (release 2.15-0 or higher)"). • J1939: ADEC ECU 7 failure code available as analog variable "09.46 ADEC ECU7 Fault code". • J1939: Volvo EMS 2 new visualization value: "09.36 Total aftertr.reagent".(Refer to ↪ "Special Volvo EMS 2 messages (release 2.10-1 or higher)".) • Modbus Master TCP provides new data type for read enum type data of a slave and to map it to multiple writable LM flags. Refer to ModbusMasterMapper PC software help file. • More flexibility in the Ethernet UDP message handling: <ul style="list-style-type: none"> ◦ Introduction of a new parameter "Timeout cycles data" for declaring data invalid ↪ 7497. ◦ The parameters "Transmission rate" and "Timeout cycles" are now configurable in codelevel 2. ◦ Refer to ↪ "6.2.2.4 Tips for commissioning load share communication via Ethernet". ◦ Refer to ↪ "6.2.4 Ethernet Communication - General Measures to optimize bus load on easYgen devices". <p>Corrections/Repairs</p> <ul style="list-style-type: none"> • Event log entries "Open command GCB" and "Open command GGB": If the opening of the breaker failed , it could happen that the corresponding open command was permanently entered in the event log. Now a new entry can only be made if the breaker was opened in the meantime or a close command was active. • The configuration of Flexible Limits 19 and 20 did not work correctly. The configuration of the limit 19 had an impact on limit 20 and vice versa. • The LDSS function in Mains Parallel Operation (MOP) being in mode Interchange, Closed transition or Open transition did not work correct. It could lead to a wrong

Rev.	Date	Editor	Changes
			<p>start and stop behaviour. This is fixed now (refer to ↪ “6.3.20 LDSS with Interchange, Closed Transit. or Open Transition”).</p> <ul style="list-style-type: none"> • Software versions 2.12-1 and older do not meet the specified maximum # of devices on Ethernet bus. A buffer is now installed in software 2.12-4 and 2.15. for more information refer to ↪ “6.2.4.5 Recommendations for Software releases before 2.15”).
K	2022-10	BS	<p>NEW Software Revision Release 2.13-0 or higher</p> <p>Due to a hardware adjustment, the software had to be changed.</p> <p>Note: This means that the hardware is not compatible with previous software versions.</p> <p>For more details on which hardware is affected, see QR Server ⇒ http://wwdmanuals.com/easygen-3500xt-p2.</p> <p>NEW features & functions</p> <ul style="list-style-type: none"> • New IKDs (IKD-IN-16, IKD-OUT-16) introduced in manual. • AVR (Exciter-10, AVRbridge): <ul style="list-style-type: none"> ◦ Introduction of new parameters improving the engine start behavior. Refer to ↪ “4.4.4.1.1 AVR”. <p>Corrections/Repairs</p> <ul style="list-style-type: none"> • Better alignment between Modbus protocol 5016 and HMI values. • Active/Reactive power values from LSx in slave mode are now also available via Modbus protocol 5016. • Corrected cylinder temperature monitoring with external analog inputs 1-16.
J	2021-09	Lu	<p>NEW Software Revision Release 2.12-1 or higher</p> <p>Corrections/Repairs</p> <ul style="list-style-type: none"> • J1939 Volvo EMS proprietary J1939 data: If “15102 Device type” is configured to “EMS2 Volvo”, the J1939 proprietary values (page “J1939 Special”) are not indicated and not passed to the corresponding LogicsManager variables (03.73 to 03.85) and AnalogManager variables (09.19 to 09.23). <p>Remote control values (like start/stop speed biasing etc.) are transmitted correctly. For this reason the engine could be controlled but no proprietary J1939 data are available in the easYgen.</p> <ul style="list-style-type: none"> • Scania S8 proprietary J1939 data: If “15102 Device type” is configured to “S8 Scania”, the J1939 proprietary values (page “J1939 Special”) are not indicated and not passed to the corresponding LogicsManager variables (14.22 to 14.35) and AnalogManager variables (09.26 to 09.29). <p>Remote control values (like start/stop speed biasing etc.) are transmitted correctly. For this reason the engine could be controlled but no proprietary J1939 data are available in the easYgen.</p> <ul style="list-style-type: none"> • J1939 failure codes DM1 and DM2 ToolKit: The J1939 failure codes DM1 and DM2 are not visible in ToolKit if “15102 Device type” is configured to the following devices: “Standard C”, “S8 Scania”, “ECU8/9 MTU” or “Hatz EDC7”. • DM1 alarms of SPN 3719, 3720 DM1: Alarms of SPNs “3719 DPF 1 Soot load” and “3720 DPF 1 Ash load” are not indicated in the alarm list.
H	2021-06	Lu	<p>NEW Software Revision Release 2.12-0 or higher</p> <p>NEW features & functions</p> <ul style="list-style-type: none"> • Breaker Logic <ul style="list-style-type: none"> ◦ Including of an additional LogicsManager “Enable GGB” to enable the GGB closing (refer to ↪ 12948). ◦ Including of an additional LogicsManager “Open GGB immediately” to open the GGB immediately (refer to ↪ 12947). • Configuration: The parameter “Parameter update rate” is now accessible in ToolKit (refer to ↪ 1896).

Rev.	Date	Editor	Changes
			<ul style="list-style-type: none"> • AVRbridge-10-P1 support prepared (refer to ↪ 4.4.4.1.1 AVR). • AVR setpoint via standard J1939 message prepared (refer to ↪ 6632). • Introduction of a new J1939 device type "Standard C" for ECUs which require counter and message checksum for TSC1 (refer to ↪ 15102). • Scania S8: Support of proprietary exhaust gas aftertreatment related J1939 messages (refer to ↪ "Special Scania S8 messages"). • Support of battery charger related J1939 messages (SPNs: 4990 to 4993). • Run-up Synchronization: Introduction of a LogicsManager command variable "04.73 Run-up synch.finished". • The setpoint indication on display is made more comfortable in regards of the source information. • Communication Ports <ul style="list-style-type: none"> ◦ The communication timeout limit for CAN load share and control messages is now configurable (refer to ↪ 9999). ◦ The communication timeout "7489 Timeout cycles" limit for Ethernet load share and control messages is now configurable with code level 2 instead of 12. ◦ New load share message timeout flags available for the event logger and as LogicsManager command variables 08.78 to 08.80 (refer to ↪ 2442). <p>Corrections/Repairs</p> <ul style="list-style-type: none"> • Code level changed <ul style="list-style-type: none"> ◦ Code level of parameter "10419 REBOOT" changed from 4 to 2. ◦ Code level of parameter "3228 Enabled" changed from 4 to 2. ◦ Code level of parameter "3203 Enabled" changed from 4 to 2. • J1939: PGN 57344 Cab Message 1 CM1 (with SPNs 3695, 3696) now with flexible destination address. • The AnalogManager variable "05.88 Manual P setp. [kW]" is now presented in kW. • Run-up Synchronization: Minor improvements were made in the run-up synchronization according to the easYgen and GC device. • Communication Ports: From easYgen version 2.10 on there are two issues recognized which are fixed now: <ul style="list-style-type: none"> ◦ 1. The timeout of the CAN load share message are too sensitive so that a load share message timeout is too early detected. ◦ 2. The CAN message send rate can have a negative impact on the Ethernet (B or B/C) timeout calculation so that a load share message timeout is too early detected. • From easYgen version 2.10 on the VNC viewer function (RP3000XT) can hang up while running VNC viewer client on PC. This is fixed now. • CANOpen Time function corrected (refer to ↪ "COB-ID of SYNC/TIME messages" and ↪ "COB-ID of SYNC/TIME messages").
		Lu	<p>NEW Software Revision Release 2.11-0 or higher</p> <p>NEW features & functions</p> <ul style="list-style-type: none"> • Breaker Logic <ul style="list-style-type: none"> ◦ The relays "Open GCB" and "Open MCB" getting now more flexibility. With the configuration "Not used" of the according relay a LogicsManager becomes active which can be used to add other argues to open the relay or to use it for own purposes refer to ↪ 3403, ↪ 3398). ◦ Including of an additional LogicsManager "Enable GCB" to enable the GCB closing (refer to ↪ 12887). ◦ Including of an additional LogicsManager "Open GCB immediately" to open the GCB immediately (refer to ↪ 12886). • Stage V support: J1939 additional "Exhaust Gas-After-Treatment" related visualization values (refer to ↪ "7.5 J1939 Protocol") and LogicsManager (refer to ↪ 7863) implemented. • Start stop logic DIESEL: The preglow mode can be interrupted with a LogicsManager "Bypass preglow time" (refer to ↪ 12885).

Rev.	Date	Editor	Changes
			<ul style="list-style-type: none"> The "Warm-up" engine run is now also usable in the operation mode TEST like in the AUTOMATIC mode. The GCB dead bus negotiation is now configurable in a way that it can be performed over all segments or only within the own segment (refer to ↪ 3472). For an improved AnalogManager and LogicsManager handling some new timer flags are available (refer to ↪ "9.3.2.11 Group 11: Clock and timer"): <ul style="list-style-type: none"> Pulse every 20 ms toggling Pulse every 100 ms pulse (all 100 ms for 20 ms TRUE) Pulse every 1000 ms pulse (all 1000 ms for 20 ms TRUE) The event logger is getting a new entry: The "03.28 Start/Gas" command is indicated (refer to ↪ "9.5.3 Event Message"). <p>Corrections/Repairs</p> <ul style="list-style-type: none"> VDE-AR-N 4105: The alarm "Missing member 4105" is wrongly indicated. This is now corrected.
		BS	<p>NEW Software Revision Release 2.10-3 or higher</p> <p>NEW features & functions</p> <ul style="list-style-type: none"> New function added to execute run-up synchronization with GC3400XT release higher than 2.10 (refer to ↪ "6.3.16.1 Configuration"). <p>Corrections/Repairs</p> <ul style="list-style-type: none"> The run-up synchronization function does not close GCB anymore during "Critical Mode without closing GCB" and "Start request w/o load". Active run-up synchronization in own segment inhibits own dead bus closure request. This prevents unexpected GCB open commands during run-up synchronization. The Modbus Master function sometimes stopped after disabling and then re-enabling by LogicsManager. This is fixed. The LSG is now recognized and indicated on display. Fault of release 2.10, 2.10-1, 2.10-2. VDE-AR-N 4105: Permanent improper "Missing member 4105" alarm for LSx devices is fixed. Fault of release 2.10, 2.10-1, 2.10-2.
G	2020-11	TM	<p>NEW Software Revision Release 2.10-2 or higher</p> <p>NEW features & functions</p> <p>None</p> <p>Corrections/Repairs</p> <ul style="list-style-type: none"> The Modbus Master function stops to read after 65000 times. This is fixed now. Modbus Master uses always the port number 501 instead of the configured one. This is fixed now.
F	2020-09	TM	<p>NEW Software Revision Release 2.10-1 or higher</p> <p>NEW features & functions</p> <ul style="list-style-type: none"> The AnalogManager variables "Free analog values" 24.05 to 24.08 are write-protected with code level CL1. In operation mode MANUAL the discrete raise/lower function is now available with configurable ramp rates. ↪ "4.4.4.7 Discrete Raise/Low Function" Expansion of the "Mains Voltage increase" monitor on up to 6 phases. To reach the component certification VDE-AR-N 4105 the password code level of some mains decoupling parameter are changed: ↪ "9.4.2.16 Group 24: Free analog values" <ul style="list-style-type: none"> Mains voltage increase limit ID8807 from code level CL2 to CL1 ↪ 8807 Mains undervoltage 1 delay time ID3005 from code level CL2 to CL1 ↪ 3005

Rev.	Date	Editor	Changes
			<ul style="list-style-type: none"> ◦ Mains undervoltage 2 delay time ID3011 from code level CL2 to CL1 ↗ 3011 • The CANopen-Interface-3 error flag was missing in the modbus protocol 5016 and is now available. ↗ "The following data protocols are implemented to be used" • Introduction of a Ethernet Address Network Check. ↗ "4.7.5 Ethernet Interfaces" • Expansion of the J1939 ECU handling. Introduction of a new sequencer file "Volvo_EMS_1.3_49058". ↗ "4.7.4.2.2 J1939 Interface" <p>Corrections/Repairs</p> <ul style="list-style-type: none"> • Application mode GCB/GC introduced in easYgen series V2.10: The connection to mains is not recognized under some circumstances. This is corrected now. • The Parameter ID511 "Remote reactive power setpoint" is getting the format (Signed INT32). This allows now to send negative kvar setpoints to the easYgen. • Start counter: Counter is now working too if changed from STOP to AUTO or TEST during Start req. in AUTO is already true and if there is no preglow. • The generator excitation limiter function and indication is disabled if reactive control in the device is disabled. • The system update trigger send from LS-6XT is not recognized in the easYgen device. This is solved. • Loadshare "Missing Member" monitoring delay time behaviour after power cycle: refer to ↗ "4.5.6.18 Multi-Unit Missing easYgen". • In cases the easYgen runs the genset with breaker transition mode "Open transition": It could lead under special circumstances that the mains settling time is shortened to 2 seconds even there is no need for. This is fixed now. • In cases the operation mode is configured in order not to go automatically into STOP due to a shutdown alarm and a MCB closure failure shall cause an emergency run: It could lead under special circumstances that the emergency run state in the event logger is steadily retriggered. This is fixed now.
E	2020-04	TM	<p>NEW Software Revision Release 2.10 or higher</p> <p>NEW features & functions</p> <ul style="list-style-type: none"> • Introduction of the "easYgen LS-6XT" (= LS-6XT) capability as an alternative to the LS-5 device. <p>Note: From now on all LS-5 and LS-6XT devices are signed as LSx devices in HMI and ToolKit. (Unless otherwise noted, "LS-5", "LSx", "LS -6XT" and "easYgen LS-6XT" are used interchangeably in this document.)</p> <ul style="list-style-type: none"> • Introduction of the Group Controller (GC) capability in the series device. A new application A13 mode is selectable. ↗ "6.1.13 Application mode A13 (GCB/GC)" • The LSx and GC application modes providing now LogicsManager variables to inform about the mains condition: <p>Refer to the LogicsManager chapter for more details.</p> <ul style="list-style-type: none"> ◦ LM flag: "07.41 LSx System A ok" ◦ LM flag: "07.42 LSx System B ok" ◦ LM flag: "07.43 LSx Mains voltage" <ul style="list-style-type: none"> • Introduction of a Modbus Master functionality. ↗ "6.5.5 Modbus master" • Introduction of a Photovoltaic (PV) inverter load reduction function including of a monitor feature. ↗ "4.4.4.8.1 Photovoltaic (PV) load reduction regulated mode" • Separate parameters for mains over/under voltage and over/under frequency hysteresis. • Writing LDSS Reserve power into the device: The device allows now a remotely frequently refreshed reserve power setting. <p>IOP: ↗ "Remote LDSS IOP reserve power "</p> <p>MOP ↗ "Remote LDSS MOP reserve power "</p> <ul style="list-style-type: none"> • Providing of a monitoring function for Ethernet issues. ↗ "4.5.6.13 Ethernet interfaces"

Rev.	Date	Editor	Changes
			<ul style="list-style-type: none"> • LDSS: The current reserve power setting (Parameter, LM Parameter or from RAM variable) is indicated in the ToolKit Status "States easYgen / Sequencing" screen. • The easYgen provides a "Reboot" parameter in ToolKit and HMI. ↪ "4.3.5.1 Reboot Function" • Communication protocols 5014 and 5016 are updated with <ul style="list-style-type: none"> ◦ Negative energy counters ◦ Active and reactive power setpoints ◦ ISOCH information • Improved System Interconnectivity by providing advanced CANopen and Modbus access on Analog- and LogicsManager variables. ↪ "9.2.9.3 Data Receive (interconnectivity)" • The redundant load share and control flag interface monitor is improved. It differentiates now redundancy lost of Ethernet B/C respectively EthA/CAN in the alarm indication. • The timer setting over the ToolKit screen is improved to make the configuration more comfortable. There are some configuration examples added. ↪ "6.3.19 Examples timer configuration" • Application modes with any LSx device: If the communication with these devices has been lost, their breaker feedback signals are assumed to be open. This has a positive impact in cases where the generator shall still be operatable in emergency situations. <p>Corrections/Repairs</p> <ul style="list-style-type: none"> • In application mode GCB/GGB/MCB or GCB/L-GGBMCB with GGB close mode and breaker closed transition mode: The issue that only 3-phase mains voltage trip leads to a correct AMF run is fixed. • Breaker transition mode "Closed Transition": Being in island mode with multiple running easYgens did not allow constant power control in the single easYgens. This is fixed now. • Phase shift (ROCOF) - Not possible to trigger in Decoupling Test Mode. This is fixed now. • The disabling of the maintenance call by configure maintenance hours and days to zero is improved. In the past one last maintenance call was executed even the hours and days were RESET. This is fixed now. • In GCB/L-GGBMCB Mode with GGB open failure: For emergency cases the breaker logic allows now the closure of the GCB even the GGB does not open. • In application mode with GCB/GGB/MCB or GCB/L-GGBMCB and breaker closed transition mode: Even the MCB has an open failure the engine stop can be handled without changing the the operation mode. • Improvement Modbus TCP slave handling: Changed receive of Modbus to fix occasional blocking of TCP port in multiple Modbus setups.
D	2019-04	PC	<p>NEW Software Revision Release 1.16 or higher</p> <p>NEW features & functions</p> <ul style="list-style-type: none"> • The FRT mains monitoring is further expanded. (VDE-AR-N 4110). See ↪ "4.5.1.3.2 Generator Overfrequency (Level 1 & 2) ANSI# 810" • The mains frequency measurement is optimized to reach faster and more reliable response times regarding mains frequency monitoring. (VDE-AR-N 4110). See ↪ "9.4.2.2 Group 02: Mains values". • Some min. and max. adjusting values for configure mains decoupling monitorings are changed to match the newest grid code demands. (VDE-AR-N 4110) • Introduction of special mains limits to maintain the resynchronization of the genset back to mains after a mains failure. (VDE-AR-N 4110). See ↪ "4.5.3.3.2 Reconnecting Mains Operating Range". • Introduction of a generator reactive power setpoint [kvar] including the capability to serve it through interface connection or any free analog input. See ↪ "Remote reactive power setpoint". • Introduction of different individually configurable reactive power setpoint filters (PT1 characteristic). (VDE-AR-N 4110). See ↪ "4.4.4.2.5 Reactive Power / Power Factor setpoint filter".

Rev.	Date	Editor	Changes
			<ul style="list-style-type: none"> • Introduction of a Reactive power - Voltage curve Q(V). (VDE-AR-N 4110). See ↪ "4.4.4.2.6 Reactive Power Characteristic". • Introduction of a Reactive power - Active power curve Q(P). (VDE-AR-N 4110). See ↪ "4.4.4.2.6.2 Reactive Power Q(P)". • Introduction of a Reactive power - Voltage curve Q(V) including voltage limitation. (VDE-AR-N 4110). See ↪ "4.4.4.2.6.3 Reactive Power Q(V) limit". • Introduction of a special mains frequency value based on a 200ms gliding average value to match an accuracy of 50mHz and better. (VDE-AR-N 4110). See ↪ "9.4.2.2 Group 02: Mains values". • The over frequency -active power decrease function is expanded with under frequency -active power increase function. (VDE-AR-N 4110). See ↪ "4.4.4.5.5 Active Power - Frequency Function P(f)". • Providing a LogicsManager command variable in order to blocking ROCOF Monitor during FRT-cases. (VDE-AR-N 4110). See: Parameter 3053 (↪ 3053) and Parameter 3103 (↪ 3103) and ↪ "9.3.2.7 Group 07: Mains related alarms". • Providing of a configurable hysteresis for mains voltage and frequency monitoring. (VDE-AR-N 4110). In Rev. E changed again. • Introduction of a pole-slip monitoring function in parallel to mains operation. (VDE-AR-N 4110) ↪ "4.5.1.6.3 Pole Slip Monitoring" • The generator negative reactive energy [kvar] is now available in the data protocols 5014 and 5016. • The AnalogManager provides now the analog variable "Number of starts". See ↪ "9.4.2.10 Group 11: Engine values". • Introduction of an AVR algorithm to send a excitation control signal to an external excitation module. See ↪ "4.4.4.1.1 AVR". • Introduction of the discret alarm redundancy load share interface B/C is lost. See ↪ "6.2.2 Communication Management". • The frequency controller "PID analog" provides now a second parameter set. See ↪ "4.4.4.4 Frequency Control". • The frequency controller can now alternatively be operated with a speed source. See ↪ "4.4.4.4 Frequency Control". • The device provides now free analog values, which can be set from remote by communication interface. See ↪ "9.4.2.16 Group 24: Free analog values". • The Windows Microsoft driver for USB interface is stored on the easYgen flash drive. • The easYgen AnalogManager pool supports direct active and reactive power [kW and kvar] coming from LS5. See ↪ "9.4.2.9 Group 10: Internal values". • The easYgen LogicsManager pool supports direct phase rotation flags coming from LS5. See ↪ "9.3.2.7 Group 07: Mains related alarms". <p>Corrections/Repairs</p> <ul style="list-style-type: none"> • L1-N [%] and L3-N [%] are in AM with wrong percentage value when measurement system = 1Ph3W. Percentage value is based on $U_n/\sqrt{3}$. It should be based on $U_n/2$.
C	2018-12	PC	<p>NEW Software Revision Release 1.15 or higher</p> <p>NEW features & functions</p> <ul style="list-style-type: none"> • To improve the handling of the AnalogManager, the following AM functions have been changed: <ul style="list-style-type: none"> ◦ "Compare with Delay On" > C1 entry changed from = [ms] to [s] ◦ "Filter" > C1 entry changed from = [ms] to [s] ◦ "Timer" > C1 entry changed from = [ms] to [s] ◦ "Delay type A" > C1 entry changed from = [ms] to [s] ◦ "Delay type B" > A1 and A2 entries changed from = [ms] to [s] ◦ "Toggle" > A1 and A2 entries changed from = [ms] to [s] ◦ "One shot" > C1 entry changed from = [ms] to [s] <p>For details see ↪ "The following AnalogManager operations are available:".</p>

Rev.	Date	Editor	Changes
			<ul style="list-style-type: none"> • Rounding of 16Bit Integers in communication protocols 5010 and 5016. AC values which are supported in a 16Bit integer format are rounded. • The service tool ToolKit allows now also an Offline Mode (For details see ToolKit Manual.) • Different timers (e.g. Cooldown), usually indicated on display, are available as AnalogManager variables and accessible by communication interface. See ↪ "9.4.2.10 Group 11: Engine values". • Introduction of new AnalogManager variables regarding RTC, counter and timer (For details see ↪ "9.4.2.9 Group 10: Internal values".) • Introduction of a customer tool for translations. Makes individual language translation of the easYgen HMI possible. For details, see ↪ "Localization Tool (for customized language)". • Now, the device provides a flag in the LogicsManager that the mains decoupling monitor is activated. See ↪ "9.3.2.2 Group 02: System conditions". • The LDSS parameter alignment monitor is expanded with the settings: <ul style="list-style-type: none"> ◦ Delay ◦ Self acknowledge ◦ Enabled <p>For details see ↪ "4.5.6.17 Multi-Unit Parameter Alignment".</p> • Introduction of the CAN protocol 5017 with all relevant alarms of an EG3000XT. For details see ↪ "9.2.5 Protocol 5011 (Alarm Values Visualization)". • Change in AnalogManager: The setpoints for W and var are reworked to kW and kvar for better configuration handling. • Support of Diesel Particle Filter SPNs according to Deutz EMR4 ECU. Refer to ↪ "7.5.2 Supported J1939 ECUs & Remote Control Messages" for details. • The time span of excitation the charging alternator (D+) is now configurable. For details, see ↪ "3.3.4 Charging Alternator". • It is now possible to fade out decimals of analog values on the HMI customer screens. For details see ↪ "4.3.2.1 Configure Customer Screens". • The free AnalogManager output values 1-16 are now usable in the CANopen PDO system. For details see ↪ "9.4.2.15 Group 21: CAN1 Receive". • J1939 MTU ECU9: The device supports from now on the function "Rapid start" and "droop". See ↪ "7.5.2 Supported J1939 ECUs & Remote Control Messages". Refer to MTU ECU9 documentation for more details. • Introduction of ECU (J1939) messages regarding diesel particle filter (DPF). See ↪ "7.5.2 Supported J1939 ECUs & Remote Control Messages". • Inverse Time Overcurrent Tp monitor: <p>The setting Inverse time overcurrent Time constant Tp can now configured on up to 5 seconds (Before 1.99s).</p> • Introduction of a new LDSS feature: LDSS with predicted load. For details see ↪ "6.3.17 LDSS with predicted load" and ↪ "4.4.3.1.7 GGB Handling". • Introduction of the J1939 handling for ECU Hatz EDC 17. For details see ↪ "7.5.2 Supported J1939 ECUs & Remote Control Messages". • General additionally J1939 SPNs implemented concerning diese partical filter (DPF). See ↪ "7.5.2 Supported J1939 ECUs & Remote Control Messages" for details. • Introduction of a new monitor: Easygen monitors ECU malfunction (emission) and protection alarm on J1939. See ↪ "7.5.2 Supported J1939 ECUs & Remote Control Messages" for details. • The device easYgen3500XT-P2 provides now a dedicated phase rotation monitor instead a LogicsManager command variable only. ↪ "4.5.1.6.2.2 Generator Phase Rotation" • Introduction of a new monitor in the easYgen: For multiple easYgen applications a MCB plausibility alarm can be used. See ↪ "4.4.4.5.4 Derating And Uprating Of Power " for details. • Introduction of breaker monitors for GCB and MCB: <p>Breaker GCB open alarm 50BF.</p> <p>Breaker MCB open alarm 50BF.</p>

Rev.	Date	Editor	Changes
			<p>See ↪ “4.5.4.1 Configure GCB” for details.</p> <ul style="list-style-type: none"> • Now, the event logger also provides the information that the "Emergency run" is finished. • Introduction of a new GGB mode. From now on, two different GGB handlings are configurable. See ↪ “4.4.3.1.7 GGB Handling” for details. • In all application modes with L-MCB the Homepage and submenu "busbar/System/LS5" indicates now Mains (LS5) instead of LS5 only. See ↪ “4.1.2 The HOME Screen” for details. • The Pmin is considered when starting engine in Parallel mode. This feature is now also available in the breaker transition mode "Parallel". See ↪ “4.4.3.1.6 Transition Modes (Breaker Logic)” for details. <p>Corrections/Repairs</p> <ul style="list-style-type: none"> • The L-GGB feedback is under some circumstances wrong recognized and accordingly wrong monitored. This is fixed now. • The event logger got trouble with the entry "Emergency run" under special circumstances. This is fixed now. • The ground fault monitor based on the CT measurement was wrongly described in the manual. This is fixed now. See ↪ “4.5.1.6.2.1 Generator Ground Fault (Level 1 & 2)” for details. • Improvements regarding Operating range monitoring included. • Setpoint Ramp active power 2 was not executed in island parallel operation. This is working correctly now. • Power Factor setpoint could not be changed in MANUAL mode. This is working correctly now. • The issue (ERRATA sheet #24) is solved: Application mode GCB/L-GGBMCB mode with breaker transition mode closed transition: During Emergency run the MCB is not served correctly. This is fixed now. • If "Generator/Busbar" is configured for Homescreen, and measurement for 1 Phase measurement is set to "Phase-neutral", then the Busbar voltage on Homescreen is always Zero (000 V), even when there is actually voltage measured. This is fixed now. • The issue (ERRATA sheet #25) is solved: Changing from Breaker transition mode "Parallel" to "Interchange" being parallel to mains and running an export power setpoint: The MCB is opened immediately without consider the power at the interchange point. This is now fixed. See ↪ “4.4.3.1.6 Transition Modes (Breaker Logic)” for details. • Falling into frequency and voltage droop during island operation (e.g. missing member) and droop tracking is enabled. This can lead to troubles with frequency and voltage control, if the MCB shall be synchronized. This is fixed now. • Improved behavior during Ethernet network errors. • Home screen engine (HMI) J1939 values. If a configured SPN is not available or having a sensor defect, HMI indicates "---".
B	2017-09	GG	<p>NEW Software Revision Release 1.14-4 or higher</p> <p>NEW features & functions</p> <ul style="list-style-type: none"> • The devices are CSA certified (For details see ↪ “8.1.8 Approvals”). • The device provides now the capability to create an own Modbus address point list, beginning with address 50,000. For this purpose WW provides a TelegramMapper software tool to create customer specific DataTelegrams. This self created DataTelegrams can be used with easYgen-XT revision 1.14 or higher. For details see ↪ “4.7.3 Modbus Protocol”. • The device offers the capability to disable the password protection for the individual interface communication channels. If the password level is disabled the access level is set on code level 5. For details see ↪ 9126, ↪ 9127, ↪ 9128, and ↪ 9129. • For running the Remote Panel RP-3000XT with the easYgen-XT, the user can dynamically switch the Remote Panel into an Full mode, Annunciator mode or Off mode. <p>See menu [Parameter / Configuration / Configure HMI / Configure Remote Panel].</p>

Rev.	Date	Editor	Changes
			<p>Corrections/Repairs</p> <ul style="list-style-type: none"> • Issue #19 described in the ERRATA sheet is solved: Indication of red and amber alarm lamps of ADEC ECU7 in easYgen did not work (ADEC ECU 7 is transmitting only one byte of DM1, eight are expected). • Issue #18 described in the ERRATA sheet is solved: Restricted to application mode GCB/L-GGB and GCB/L-GGB/L-MCB only: The feedback of the LS-5 installed over the GGB was always recognized as closed. • Issue #17 described in the ERRATA sheet is solved: Application mode GCB/MCB together with "GCB auto unlock": If emergency run was active, "GCB auto unlock" could have caused simultaneous dead bus closure of GCB and MCB if mains returned during the "GCB open pulse". This could only happen in parallel logic if the "GCB open time pulse" (5708) was configured higher or same than 2 s. (This was because the mains settling time - which is shortened to 2 s in emergency case - and the "GCB open time pulse" were mismatched.) • Issue #16 described in the ERRATA sheet is solved: Generator power factor monitoring works now even if generator measurement is configured to 3PH3W. • Issue #15 described in the ERRATA sheet is solved: All visualization values of ADEC ECU7 are indicated now. • Issue #13 described in the ERRATA sheet is solved: MCB plausibility alarm works fine now: If MCB was not enabled (12923 = FALSE) and start without load was active and emergency run was active, the GCB no longer will be frequently closed and opened. • The active power setpoint can be changed now even in island mode and with load control enabled. • The event logger stores from now, when the engine has stopped. Until now only the starting information was stored. • GCB no longer opens and closes permanently if emergency and start without load • Setpoint Ramp active power 2 is executed in island parallel operation, too • Busbar display and voltage of busbar is correct now (HMI and ToolKit), even if "Generator/Busbar" is configured for HOME screen, and measurement for 1 Phase measurement is set to "Phase-Neutral". The Busbar voltage on HOME screen is no longer always Zero (000 V) when there is actually voltage measured. • Mains decoupling screen: Text "Overfreq." is changed to "Overfreq.2" and text "Underfreq." is changed to "Underfreq.2" • Screens "Configure Breaker", "Monitor Breaker": Corrected hide/unhide of links and buttons for GGB • The buttons had no function and this is now corrected: <ul style="list-style-type: none"> ◦ "Test ON"/"Test OFF" under [Next Page / Diagnostic / Mains decoupling / Mains decoupling thresholds] ◦ "Execute" under [Next Page / Diagnostic / Mains decoupling / Mains decoupling test] ◦ [Measured values / Busbar]: Corrected jump at arrow down for non configurable busbar with breaker mode with LS5 ◦ [Measured values / Busbar/System/LSx]: corrected jump at arrow up for non configurable busbar with breaker mode with LS5 • MANual operation mode: <ul style="list-style-type: none"> ◦ The power factor setpoint is now adjustable, if the device runs power factor control. ◦ In island- or mains parallel operation and when switching the device into operation mode STOP, the unloading of the generator now is executed before opening the GCB.

Rev.	Date	Editor	Changes
			<ul style="list-style-type: none"> ◦ If an analog output is configured to a discrete +/- setpoint (e.g. 05.64), the value will be updated now. • If emergency run is active (no mains) AND operating mode is fixed to AUTOMATIC via LogicsManager AND an alarm of class C..F occurs, the Command Variable »Emergency run« (04.09) no longer toggles for 2 s and so does not generate lot of entries in the event history. • CAN J1939 address claiming: Device did not answer on address claiming request. • CAN: The baud rate handling in all CAN communication ports has been optimized. • During cranking: Crank relay could have toggled if speed (measured via MPU) jittered around firing speed. <p>Technical Manual updated</p> <ul style="list-style-type: none"> • Description, images, and tables updated according to the new features, functions, and corrections listed above. • The Ethernet port is named Ethernet #1 or Ethernet A which means the same. • Two symbols "generator Add-on/Add-off" explained (see ↪ "4.1.5.4 Sequencing"). • Load Control example updated (see ↪ ↻). • NOTE added: Use Pin 61 or (metal housing) protective earth, see ↪ "6.3.9 Wiring Self Powered Discrete Inputs". • More user-friendly description of remotely changing setpoints (see ↪ "6.4.1.7 Remotely Changing The Setpoint" and ↪ "6.5.1.3 Remotely Changing The Setpoint"). • Settings proposal for J1939 communication with Cummins ECU (see ↪ "7.5.2 Supported J1939 ECUs & Remote Control Messages"). • Product label with Unom (see ↪ "8.1 Technical Data"). • Data Protocols updated: <ul style="list-style-type: none"> ◦ 5003, start addr. 450066, ID 10149 ◦ 5003, start addr. 450120, ID 10298 ◦ 5010, start addr. 450111, ID8009 ◦ 5014, start addr. 450066, ID 4087 ◦ 5014, start addr. 450136, ID 4090 • LogicsManager References update: <ul style="list-style-type: none"> ◦ 07.xx: IDs changed ◦ 09.xx: IDs changed ◦ 10.xx: IDs changed ◦ 11.xx: IDs changed ◦ 13.xx: IDs changed ◦ 15.xx: IDs changed • Layout optimizations and typo corrections.
A	2016-12	GG	<p>NEW Software Revision Release 1.13 or higher</p> <p>NEW features & functions</p> <ul style="list-style-type: none"> • A new application mode is available: GCB/L-GGBMCB. <p>In this application mode, the easYgen-XT controls the connected LS-5 device (version V2.0002 and higher) at the interchange point.</p> <p>For details refer to ↪ "6.1.12 Application mode A12 (GCB/L-GGBMCB)" (and ↪ "2.2 Application Modes Overview" for overview).</p> <ul style="list-style-type: none"> • A customer specific device name can be entered and will be used e.g. as device name in Ethernet network. For more details refer to ↪ "4.3.5 System Management". • Run-up synchronization is possible even without connected speed sensor, if in a single application the genset shall magnetize a power transformer. <p>For details refer to ↪ "6.3.16.2.4 Run-Up Synchronization without Speed Sensor".</p>

Rev.	Date	Editor	Changes
			<ul style="list-style-type: none"> • The breaker closed transition time in the mode GCB/MCB has been optimized to match the <100 ms duration time. Refer to ↪ "Breaker logic "CLOSED TRANSIT."" for details. • easYgen-XT in conjunction with the LS-5 (version V2.0002 and higher) can synchronize even with negative slipping frequency: LS-5 is switching the easYgen to a special slip frequency offset. For details refer to description of parameter ↪ 6676 in this document and parameter 5709 in the LS-5 (Technical Manuals 37649/37650). • The frequency measurements based on phase-phase and phase-neutral voltages are monitored on plausibility. For details refer to ↪ "4.5.1.3.1 Plausibility Check of Voltages' AC Wiring". • All monitoring functions in the device are from now on expanded with an additional functionality: <ul style="list-style-type: none"> ◦ Each monitor can be individually enabled by an internal LogicsManager flag. (For example refer to parameter »Enabled« ↪ "4.5.1.3.2 Generator Overfrequency (Level 1 & 2) ANSI# 810"). • Both alarm class configuration parameters ↪ 2601 for GCB and ↪ 2621 for MCB now additionally offer the possibility to select "Control". • The Node-ID of the device in a CAN bus network can be automatically pre-set with the device number. Parameter ↪ 1894 »Align device no. with Node-ID« must be configured to "Yes". This will avoid same-number-mismatch. • AnalogManager became even more flexible: <ul style="list-style-type: none"> ◦ 16 free configurable and accessible constants enable pre-sets to be used as AnalogManager input. For details refer to ↪ "4.9.2 AnalogManager Constants". • ECU J1939: The transmission rate of PGN 64913 has been changed. For details refer to ↪ "7.5 J1939 Protocol". • Fuel level monitoring offers two further SPN available via J1939 interface (refer to ↪ "Standard visualization messages") and ↪ "9.2.7 Protocol 5016 (Basic Visualization)": <ul style="list-style-type: none"> ◦ SPN 96: 96:Fuel level 1 ◦ SPN 38: 09.15 38:Fuel level 2 • »Generator Total AC Power« PGN 65029 is send to Scania S6 ECU via J1939 protocol. For details refer to ↪ "7.5.3 Device Types "Standard" and "Standard C"". • Load sharing interface can be switched between CAN and Ethernet. Refer to parameter »Load share interface« ↪ 9924 for details. • Power factor values display (generator and mains) enhanced: Three instead two decimal places. Refer to ↪ "8.3 Accuracy" for details. • The "Protection Lamp DM1" status of the J1939 communication is from now on available as LogicsManager command variable "03.44 Protection lamp DM1". Refer to ↪ "9.3.2.3 Group 03: Engine control" for details. • Max number of logged events enhanced: 1000 events saved now instead of 300 before. Refer to ↪ "9.5.2 Event History" for details. • The device stores from now on the three generator current slave pointers in a non-volatile memory. • Device identification via settings file: Serial number will be part of the .wset file generated and saved via ToolKit. Device identification, file management, and support request become much easier. • The readme.txt file in the device additionally informs, that the Technical Manual saved in the device will not be updated when executing a firmware update. <p>Corrections/Repairs</p> <ul style="list-style-type: none"> • Issue #14 described in the ERRATA sheet is solved: If ECU Device type (parameter 15102) is configured to "EGS Woodward", it can happen, that the easYgen is transmitting SPN 189 too slowly. This would cause an "Easygen 3000 communication timeout" in the E3 and twinkling of the SPN 189 indication at the E3. • Issue #13 described in the ERRATA sheet is solved:

Rev.	Date	Editor	Changes
			<p>SPN 189 "Engine rated speed" is transmitted in time, so "Easygen 3000 communication timeout" J1939 E3 communication will not occur even if ECU Device type (parameter 15102) is configured to "EGS Woodward".</p> <ul style="list-style-type: none"> Issue #10 described in the ERRATA sheet is solved: <p>The easYgen-XT is not making a reboot procedure if a Modbus TCP write order is executed on a password protected parameter just at that moment the password level expires.</p> <ul style="list-style-type: none"> Issue #9 described in the ERRATA sheet is solved: <p>An additional PHOENIX CAN coupler device is supported:</p> <ul style="list-style-type: none"> PHOENIX 27 02 23 0 (with firmware 101 or higher). <ul style="list-style-type: none"> Issue #7 described in the ERRATA sheet is resolved: <p>Island mode:</p> <ul style="list-style-type: none"> If - during warm-up - the genset becomes the single engine (by unexpected drop-out of parallel genset), the warm-up is interrupted immediately to avoid dead busbar. <ul style="list-style-type: none"> Issue #6 described in the ERRATA sheet is solved: <p>PC/laptop with operating system Windows 8.1 and ToolKit running:</p> <ul style="list-style-type: none"> USB connection handling is improved. <ul style="list-style-type: none"> Phase rotation (mismatch) measurement changed: Based now on phase-phase voltages instead of phase-neutral voltages. Complete HMI/display text translated: English text fragments replaced by local wording. GCB/MCB mode: <ul style="list-style-type: none"> The closed transition time of the breaker matches the duration time of <100 ms. Refer to ↪ "Breaker logic "CLOSED TRANSIT."" for details. <p>Technical Manual</p> <ul style="list-style-type: none"> Small corrections: <ul style="list-style-type: none"> ↪ "3.3.11.1 Connecting 24 V Relays" re-arranged: <ul style="list-style-type: none"> Moved below ↪ "3.3.11 Relay Outputs (LogicsManager)". Cable recommendations updated: <ul style="list-style-type: none"> General note instead of repeating separately with sub-chapters (see ↪ "3.3.2 Wiring Diagram" ff) Cable length recommended (see ↪ "3.4.1 Interfaces overview") A_{max} added (see ↪ "3.4.2 RS-485 Interface" and ↪ "3.4.4 CAN Bus Interfaces") Description, images, and tables updated according to the new features and functions listed above. Wiring terminals added. For details refer to ↪ "3.3.2 Wiring Diagram". Terminal assignment corrected. For details refer to ↪ "3.3.5.3.3 Parameter Setting '1Ph 3W' (1-phase, 3-wire)". Home screen values of Busbar are voltage, power, and frequency. For details refer to ↪ "4.1.2 The HOME Screen". Wrench button (softkey) explained. For details refer to ↪ "4.1.4.3 Status/ Monitoring Screens". Further WAGO devices expand I/O via CAN 2. For details refer to ↪ "6.3.11 Setup Expansion Modules at CAN 2". Relation between »Monitoring delay time« and »Engine monitoring delay time« explained in more detail. Refer to ↪ "6.3.5 Performing Remote Start/Stop And Acknowledgment". Explained in more detail: <ul style="list-style-type: none"> ↪ "6.5.1.3 Remotely Changing The Setpoint"

1 General Information

1.1 Revision History

Rev.	Date	Editor	Changes
			<ul style="list-style-type: none"> ◦ ↪ “6.4.1.7 Remotely Changing The Setpoint” • "Main" screen renamed to "Home" screen. Refer to ↪ “4.1.5.1 HOME Screen Voltage Display” for details. • Technical Data of display added. For details refer to ↪ “8.1.6 Display (plastic housing variant, only)”. • Marine approvals updated - no longer pending. For details refer to ↪ “8.1.8 Approvals”.
NEW	2016-09	GG	<p>Technical Manual - 1st issue</p> <ul style="list-style-type: none"> • Describing device software release 1.12-2 or higher <p>Notes</p> <p>New device features & updates in comparison to easYgen-3000 series will be found in the transition manual #37625. Please check availability at Woodward web site www.woodward.com.</p>



Up to date documentation?

Please check Woodward web site for latest revision of this Technical Manual (search for: “B37581”) and if there is an Errata Sheet with latest information (search for: “37619”).

The Technical Manual saved inside the device WILL NOT be automatically updated with a device update but manual update can be done on customer’s side using the USB connection.

1.2 Depiction Of Notes And Instructions

Safety instructions

Safety instructions are marked with symbols in these instructions. The safety instructions are always introduced by signal words that express the extent of the danger.

DANGER!



This combination of symbol and signal word indicates an immediately-dangerous situation that could cause death or severe injuries if not avoided.

WARNING!



This combination of symbol and signal word indicates a possibly-dangerous situation that could cause death or severe injuries if it is not avoided.

CAUTION!



This combination of symbol and signal word indicates a possibly-dangerous situation that could cause slight injuries if it is not avoided.

NOTICE!



This combination of symbol and signal word indicates a possibly-dangerous situation that could cause property and environmental damage if it is not avoided.

Tips and recommendations





This symbol indicates useful tips and recommendations as well as information for efficient and trouble-free operation.

Additional markings

To emphasize instructions, results, lists, references, and other elements, the following markings are used in these instructions:

Marking	Explanation
⚙	Start of a procedure list
>	Prerequisite for a procedure list
▷	Step-by-step instructions
▶	Results of action steps
↪	References to sections of these instructions and to other relevant documents

Marking	Explanation
•	Listing without fixed sequence
*	Example
»Buttons«	Operating elements (e.g. buttons, switches), display elements (e.g. signal lamps)
»Display«	Screen elements (e.g. buttons, programming of function keys)
[Screen xx / Screen xy / Screen xz] ...	Menu path. The following information and setting refer to a page on HMI screen or ToolKit located as described here.
	Some parameters/settings/screens are available only either in ToolKit or in HMI/display.



Dimensions in Figures

All dimensions shown with no units specified are in **mm**.

1.2.1 Copyright And Disclaimer

Disclaimer

All information and instructions in this manual have been provided under due consideration of applicable guidelines and regulations, the current and known state of the art, as well as our many years of in-house experience. Woodward assumes no liability for any damages due to:

- Failure to comply with the instructions in this manual
- Improper use / misuse
- Willful operation by non-authorized persons
- Unauthorized conversions or non-approved technical modifications
- Use of non-approved spare parts

The originator is solely liable for the full extent for damages caused by such conduct. The obligations agreed-upon in the delivery contract, the general terms and conditions, the manufacturer’s delivery conditions, and the statutory regulations valid at the time the contract was concluded, apply.

Copyright

This manual is protected by copyright. No part of this manual may be reproduced in any form or incorporated into any information retrieval system without written permission of Woodward GmbH.

Delivery of this manual to third parties, duplication in any form - including excerpts - as well as exploitation and/or communication of the content, are not permitted without a written declaration of release by Woodward GmbH.

Actions to the contrary will entitle us to claim compensation for damages. We expressly reserve the right to raise any further accessory claims.

1.2.2 Service And Warranty

Our Customer Service is available for technical information.

For regional support, please refer to: ⇒ http://www.woodward.com/Support_pgd.aspx.

In addition, our employees are constantly interested in new information and experiences that arise from usage and could be valuable for the improvement of our products.

Warranty terms



Please enquire about the terms of warranty from your nearest Woodward representative.

For our contact search webpage please go to: ⇒ <http://www.woodward.com/Directory.aspx>

1.3 Safety

NOTICE!



Damage due to improper use!

Improper use of the device may cause damage to the device as well as connected components.

Improper use includes, but is not limited to:

- Storage, transport, and operation outside the specified conditions.

1.3.1 Personnel

WARNING!



Hazards due to insufficiently qualified personnel!

If unqualified personnel perform work on or with the control unit hazards may arise which can cause serious injury and substantial damage to property.

- Therefore, all work must only be carried out by appropriately qualified personnel.

This manual specifies the personnel qualifications required for the different areas of work, listed below:

Personnel:

- **Qualified electrician**

The qualified electrician is able to execute tasks on electrical equipment and independently detect and avoid any possible dangers due to his training, expertise and experience, as well as knowledge of all applicable regulations.

The qualified electrician has been specially trained for the work environment in which he is active and is familiar with all relevant standards and regulations.

- **User**

The user operates the device within the limits of its intended use, without additional previous knowledge but according to the instructions and safety notes in this manual.

The workforce must only consist of persons who can be expected to carry out their work reliably. Persons with impaired reactions due to, for example, the consumption of drugs, alcohol, or medication are prohibited.

When selecting personnel, the age-related and occupation-related regulations governing the usage location must be observed.

1.3.2 General Safety Notes

Electrical hazards

DANGER!



Life-threatening hazard from electric shock!

There is an imminent life-threatening hazard from electric shocks from live parts. Damage to insulation or to specific components can pose a life-threatening hazard.

- Only a qualified electrician should perform work on the electrical equipment.
- Immediately switch off the power supply and have it repaired if there is damage to the insulation.
- Before beginning work at live parts of electrical systems and resources, cut the electricity and ensure it remains off for the duration of the work. Comply with the five safety rules in the process:
 - cut electricity;
 - safeguard against restart;
 - ensure electricity is not flowing;
 - earth and short-circuit; and
 - cover or shield neighboring live parts.
- Never bypass a fuse or render it inoperable. Always use the correct amperage when changing a fuse.
- Keep moisture away from live parts. Moisture can cause short circuits.

Prime mover safety

WARNING!



Hazards due to insufficient prime mover protection

The engine, turbine, or other type of prime mover should be equipped with an overspeed (over-temperature, or over-pressure, where applicable) shutdown device(s), that operates totally independently of the prime mover control device(s) to protect against runaway or damage to the engine, turbine, or other type of prime mover with possible personal injury or loss of life should the mechanical-hydraulic governor(s) or electric control(s), the actuator(s), fuel control(s), the driving mechanism(s), the linkage(s), or the controlled device(s) fail.

Device implemented self test

this Woodward device has a self test check implemented. Permanently under control are:

- processor function and
- supply voltage.

The internal signal "self check" is aligned in series with the inverse signal »Ready for op. OFF« parameter \hookrightarrow 12580. Per default (factory settings) discrete output R01 is energized/closed if device itself is OK.

LogicsManager (LM) equation parameter \hookrightarrow 12580 allows to customize this safety relay. You can use the result of this equation: LM command variable "99.01 LM: Ready for op. OFF".



Be careful in changing safety relevant settings!

CAUTION!



Uncontrolled operation due to faulty configuration

The discrete output "Ready for operation" must be wired in series with an emergency stop function.

This means that it must be ensured that the generator circuit breaker is opened and the engine is stopped if this discrete output is de-energized.

If the availability of the plant is important, this fault must be signaled independently from the unit.

Modifications

WARNING!



Hazards due to unauthorized modifications

Any unauthorized modifications to or use of this equipment outside its specified mechanical, electrical, or other operating limits may cause personal injury and/or property damage, including damage to the equipment.

Any unauthorized modifications:

- constitute "misuse" and/or "negligence" within the meaning of the product warranty thereby excluding warranty coverage for any resulting damage
- invalidate product certifications or listings.

Use of batteries/alternators

NOTICE!



Damage to the control system due to improper handling

Disconnecting a battery from a control system that uses an alternator or battery-charging device whilst the charging device is still connected causes damage to the control system.

- Make sure the charging device is turned off before disconnecting the battery from the system.



Unit includes a lithium backup battery for Real Time Clock. Field replacement of the battery is not allowed.

In case of battery replacement please contact your Woodward service partner.

Electrostatic discharge



- Protective equipment: ESD wrist band



NOTICE!



Damage from electrostatic discharge

All electronic equipment sensitive to damage from electrostatic discharge, which can cause the control unit to malfunction or fail.

- To protect electronic components from static damage, take the precautions listed below.

1. ▷ Avoid build-up of static electricity on your body by not wearing clothing made of synthetic materials. Wear cotton or cotton-blend materials as much as possible because these do not store static electric charges as easily as synthetics.
2. ▷  Before working on terminals on the control unit, ground yourself by touching and holding a grounded metal object (pipes, cabinets, equipment, etc.) to discharge any static electricity.
Alternatively wear an ESD wrist band connected to ground.
3. ▷  Before any maintenance work on the control unit, ground yourself by touching and holding a grounded metal object (pipes, cabinets, equipment, etc.) to discharge any static electricity.
Alternatively wear an ESD wrist band connected to ground.
4. ▷ Keep plastic, vinyl, and Styrofoam materials (such as plastic or Styrofoam cups, cigarette packages, cellophane wrappers, vinyl books or folders, plastic bottles, etc.) away from the control unit, modules and work area.
5. ▷ Opening the control cover may void the unit warranty. Do not remove the printed circuit board (PCB) from the control cabinet unless instructed by this manual.



If instructed by this manual to remove the PCB from the control cabinet, follow these precautions:

- Ensure that the device is completely voltage-free (all connectors have to be disconnected).
- Do not touch any part of the PCB except the edges.
- Do not touch the electrical conductors, connectors, or components with conductive devices or with bare hands.
- When replacing a PCB, keep the new PCB in the plastic antistatic protective bag it comes in until you are ready to install it. Immediately after removing the old PCB from the control cabinet, place it in the antistatic protective bag.



For additional information on how to prevent damage to electronic components caused by improper handling, read and observe the precautions in:

- "Woodward manual 82715, Guide for Handling and Protection of Electronic Controls, Printed Circuit Boards, and Modules".

Notes on marine usage

Marine usage of the easYgen genset control requires additional precautions as listed below:



The specified marine approvals are initially only valid for metal housing units. They are only valid for plastic housing units, if they are installed using the screw kit .

- Use all 12 screws and tighten accordingly.
- The easYgen-3000(XT) Series has an internally isolated power supply.



Some additional, independent safety and protection devices are necessary to meet safety requirements of Rules and Regulations of marine Classification Societies.

- Please refer to the corresponding documents issued by marine Classification Societies for the applicable requirements.



The easYgen is type approved by LR Lloyd's Register.

- Please consider for final functional arrangements to comply with appropriate Lloyd's Register Rules as subject of the Plan Approval process.

1.3.3 Protective Equipment And Tools

Protective gear

Personal protective equipment serves to protect risks to the safety and health of persons as well as to protect delicate components during work.

Certain tasks presented in this manual require the personnel to wear protective equipment. Specific required equipment is listed in each individual set of instructions.

The cumulative required personal protective equipment is detailed below:

Protective equipment: ESD wrist band

The ESD (**e**lectro**s**tatic **d**ischarge) wrist band keeps the user's body set to ground potential. This measure protects sensitive electronic components from damage due to electrostatic discharge.

Tools

Use of the proper tools ensures successful and safe execution of tasks presented in this manual.

Specific required tools are listed in each individual set of instructions.

The cumulative required tools are detailed below:

Special tool: Torque screwdriver

A torque-screwdriver allow fastening of screws to a precisely specified torque.

- Note the required torque range individually specified in the tasks listed in this manual.

1.3.4 Intended Use

The genset control unit has been designed and constructed solely for the intended use described in this manual.

The easYgen-... devices are available in two different enclosures. They are designed to be installed either on the back plate of a switch gear cabinet (e.g. easYgen-x100.../...-x400...) or on the front plate of a switch gear panel (e.g. easYgen-x200.../...-x500...).The terminals are always located on the inner side of the housing.

The genset control unit must be used exclusively for engine-generator system management applications.

- Intended use requires operation of the control unit within the specifications listed in [↳ “8.1 Technical Data”](#).
- All permissible applications are outlined in [↳ “2.2 Application Modes Overview”](#).
- Intended use also includes compliance with all instructions and safety notes presented in this manual.
- Any use which exceeds or differs from the intended use shall be considered improper use!
- No claims of any kind for damage will be entertained if such claims result from improper use.

2 System Overview

2.1 Display And Status Indicators



HMI and ToolKit are aligned for the same sequence and structure of functions and parameters.



Restrictions

Full access to all parameters and settings with ToolKit only!



Low ambient temperature (LT)

easYgen-3x00XT-P1-LT - the special version of the plastic housing device with HMI/ display - is equipped with a heatable display.

Heater is automatically switched ON when ambient temperature drops below -20 °C and the result »86.34 LM: Enable heater« (11972) of LM »7799 Enable front foil heater« is TRUE. Even if the device has no front foil heater because it is no ...-LT variant, both the LogicsManager and the parameter are available but without function!

During heating period the power consumption is increased by 7.5 W.

WARNING!



HMI buttons can be locked!

HMI buttons can be locked/unlocked with the LogicsManager LM  12978 »Lock keypad«. Check/use with Logical Command Variable 86.30 (11924).

2.1.1 HMI: Display and Buttons

Front Panel Overview

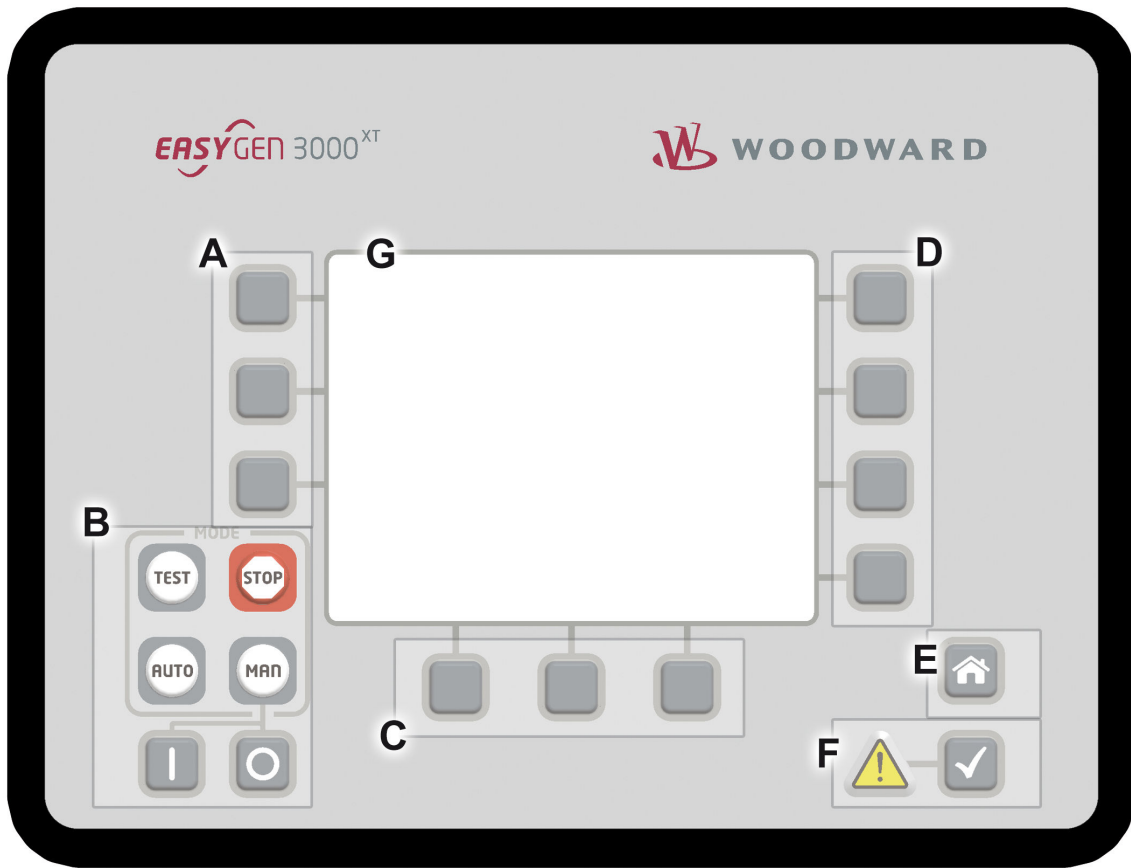

Fig. 3: Front Panel, Overview of Functional Groups of easYgen-3000XT with plastic housing

- A Softbutton Group "Display"
- B Button Group "MODE"
- C Softbutton Group "Operation"
- D Softbutton Group "Navigation"
- E "Home" (screen) button
- F Group "ALARMS" (sign and button)
- G LCD Display (Screen)

A "Display" Change the method of voltage and power calculations displayed, select Custom Screen, navigate through menu screens.

2 System Overview

2.1.1 HMI: Display and Buttons

- C
"Operation" Perform manual operation of the genset and the breakers (Single Line Diagram).
Sometimes used for settings' input.
- D
"Navigation" Navigation between system and configuration screens, and alarm list.

Front Panel (HMI) in Detail

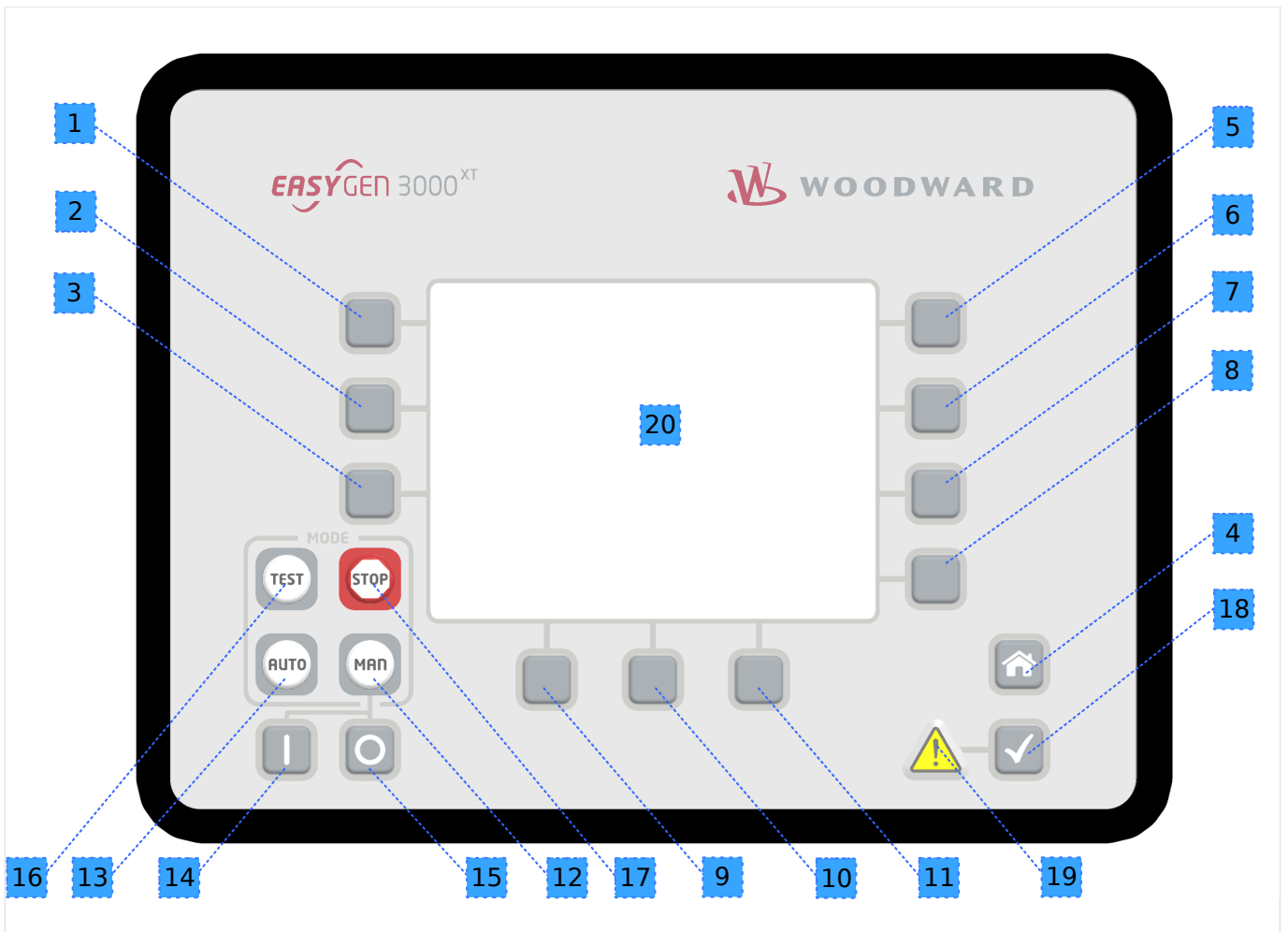

Fig. 4: Front panel of easYgen-3000XT with plastic housing

- 1..3, 5..11 Softkey Buttons; momentary function visible in "Display" (20)
- 9..11 Softkey Buttons controlling system via Single Line Diagram (if visible)
- 4 HOME Button: Back to main screen with one click only
- 18..19 Warning sign (illuminated by warning) and alarm acknowledge button
- 12..17 Button Group "Modes"
- 12, 13, 16, MODE selectors, illuminated
- 17 STOP MODE
- 12 MANUAL MODE
- 13 AUTO MODE
- 16 TEST MODE
- 14 START prime mover in MANUAL MODE
- 15 STOP prime mover in MANUAL MODE
- 20 Display

The states of the buttons (pressed/not pressed) are available as LogicsManager variables (refer to [↩️➤ “9.3.2.18 Group 18: Buttons”](#)).



Numbers with light blue (grey) background point to directly display related buttons: the softkeys and the home button.

Display

The display shows context-sensitive softkey symbols, the Single Line Diagram, measuring values, monitoring values and graphs, modes of operation, (graphic) equations of LogicsManager (LM) and AnalogManager (AM), and alarms.



Restrictions of Text Length Displayed

Depending on the available free space, at some positions in the display only the following amount of characters is visible:

- the first 20 ASCII characters







or

- the first 7 Chinese characters

or

- the first 8 Japanese characters.

- Five “Home Screen” display alternatives are available:
 - Generator
 - Generator/Mains
 - Generator/Busbar
 - Generator/Engine
 - Generator/LS-5
 - The "selection" of the displayed parameters is depending on softbutton »display mode«
- “Home Screen” Generator values are:
 - Voltage, power, frequency, power factor, and three currents
- “Home Screen” Generator/Mains values are:
 - The mains is indicated with voltage, power, frequency, power factor, and current
 - The generator is indicated with voltage, power, frequency, power factor, and three currents
- “Home Screen” Generator/Busbar values are:
 - The busbar is indicated with voltage and frequency

- Additionally the generated active power of all easYgens (in the same segment) are displayed
- “Home Screen” Generator/Engine values are:
 -  Engine speed (rpm)
 -  Oil pressure (bar or psi)
 -  Water temperature (°C or °F)
 -  Operating hours (h)
 -  Battery voltage (V)
 -  Fuel level (%)
- “Home Screen” Generator/LS-5 values are:
 - The LS-5 is indicated with voltage, power and frequency
- Two display brightness levels can be switched by LogicsManager. Can be used for e.g.:
 - Key activation determined
 - Brightness reduction on navigation bridge (vessels)
 - Saving energyFind menu: [Parameter / Configure HMI / Configure display]
- Lock keypad function is determined by LogicsManager
Find menu (ToolKit only!): [Parameter / Configure HMI / Configure display]

Special screen: "CPU Load diagnostic"

Located: Next Page/Diagnostic/Miscellaneous/CPU Load diagnostic

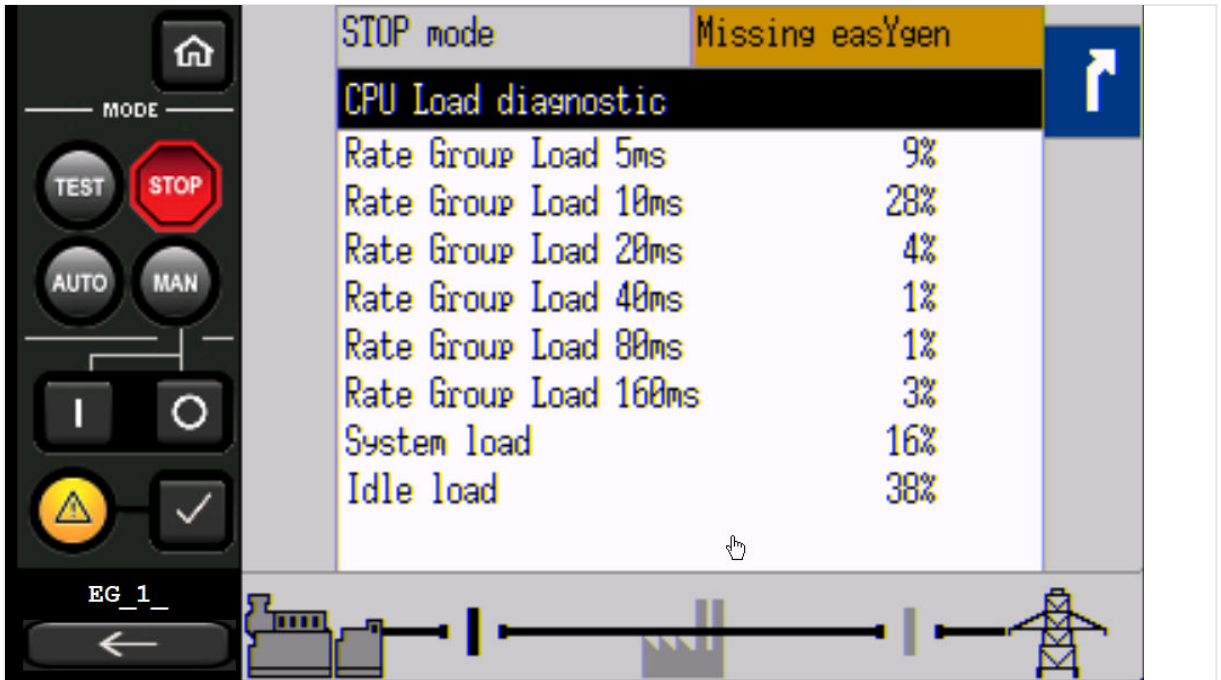

Fig. 5: CPU Load Diagnostic screen (only at HMI and Remote panel)

Illuminated Buttons/Warning

"Buttons" 14: operation mode STOP active (blinking if speed detected)
 15: operation mode MANUAL active
 18: operation mode AUTOMATIC active
 19: operation mode TEST active (starts blinking 5 seconds before TEST mode with timer exceeds)

"ALARMS" 10 (Warning sign triangle):
Slow blinking (about once per second): Alarm messages are active and **not acknowledged** in the control unit.
Fast blinking (about 6 times per second): Internal copy process after flashing a software update is still running or load the default settings is initiated.
Permanently illuminated: Alarm message is acknowledged (horn reset) but still pending.

The HOME Button

NEW and updated features

- The "Home Screen" button provides an one-click-jump back to the overview starting point

STOP Mode button

The "STOP" button is always ready (independent of context) but function depends on operating mode! **It is a "STOP-Mode" button!**

When operating modes are selected externally (via "86.16 LM: Operat. mode AUTO", "86.17 LM: Operat. mode MAN", "86.18 LM: Operat. mode STOP" or "86.29 LM: Operat. mode TEST"), the STOP, AUTO, TEST and MAN Mode buttons are disabled automatically.

This is also the case when "86.30 LM: Lock keypad 1" is active.

Custom. Button

Fig. 6: Softbuttons: Customized screen 1, 2

Two customizable softbuttons »1« and »2«

- allow own indications to display engine and auxiliary values, for example.
Find menu: [Parameter / Configure HMI / Configure customer screen 1],
and [Parameter / Configure HMI / Configure customer screen 2]
- (full access via ToolKit only; name/description cannot be changed via HMI)

2.1.2 LEDs Indicate State of Metal Housing Variant

The metal housing variant is coming with two DUO LEDs red/green/orange (orange = red/green simultaneously):

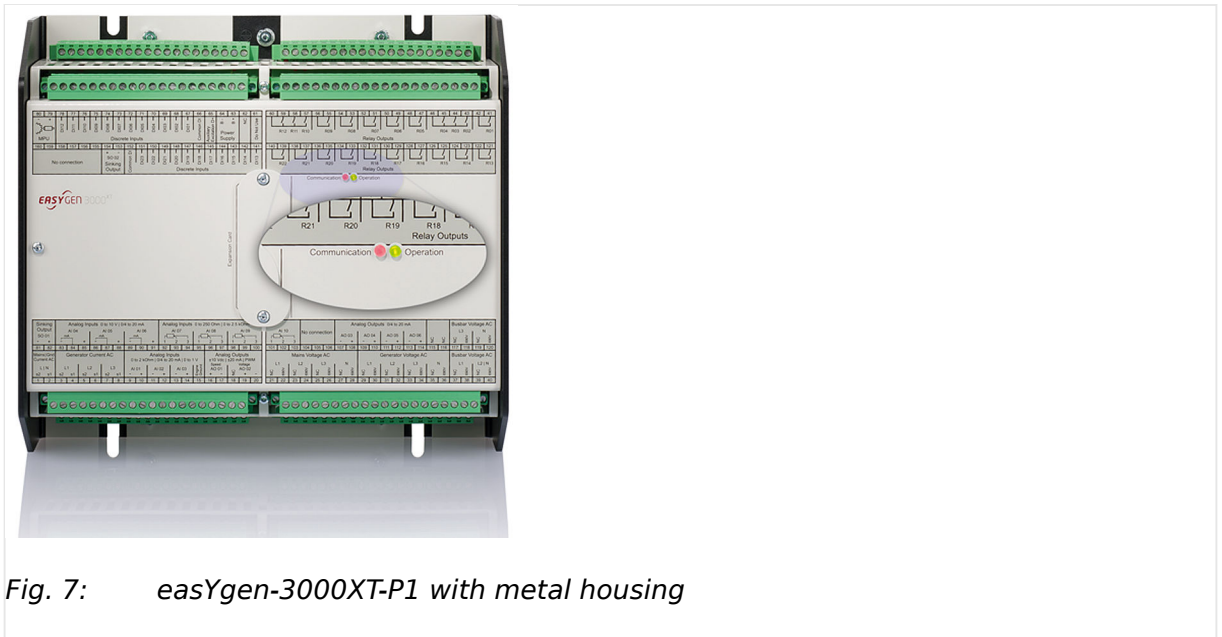

Fig. 7: easYgen-3000XT-P1 with metal housing

- »Communication« for visualizing communication state:
 - Off: no data received by any CAN port
 - Toggling green/off: any data is received by any CAN port
 - Red: missing member alarm is active
 - Toggling red/green: missing member is active and data received by any CAN port
- »Operation« for device state indication:
 - Off: the unit is not ready for operation (depending on LogicsManager "Ready for operation)
 - Green: the unit is ready for operation and no alarm is active or latched
 - Toggling green/red: the unit is ready for operation and a warning alarm in the system is active or latched
 - Red: the unit is ready for operation and a shutdown alarm in the system is active or latched.
 - Green blinking fast (about 6 times per second) and red is permanently off: Internal copy process after flashing a software update is still running or "Load default settings" is initiated

2.2 Application Modes Overview

The genset control provides the following basic functions via the application modes listed below.



For detailed information on the application modes and special applications refer to ["Device status"](#).

Application mode	Symbol	Function
None	A01	<p>No breaker control.</p> <p>This application mode provides the following functions:</p> <ul style="list-style-type: none"> • Measuring of engine/generator parameters (i.e. voltage, frequency, current, power, coolant temperature, oil pressure, etc.) • Engine start/stop
GCB open	A02	<p>GCB control (open)</p> <p>This application mode provides the following functions:</p> <ul style="list-style-type: none"> • Measuring of engine/generator parameters (i.e. voltage, frequency, current, power, coolant temperature, oil pressure, etc.) • Engine start/stop • Engine/generator protection (relay output to open GCB) • Mains failure detection with mains decoupling (GCB)
GCB	A03	<p>GCB control (open/close)</p> <p>This application mode provides the following functions:</p> <ul style="list-style-type: none"> • Measuring of engine/generator parameters (i.e. voltage, frequency, current, power, coolant temperature, oil pressure, etc.) • Engine start/stop • Engine/generator protection (relay output to open GCB) • GCB operation (relay output to close GCB) • Mains failure detection with mains decoupling (GCB)
GCB/MCB	A04	<p>GCB/MCB control (open/close)</p> <p>This application mode provides the following functions:</p> <ul style="list-style-type: none"> • Measuring of engine/generator parameters (i.e. voltage, frequency, current, power, coolant temperature, oil pressure, etc.) • Engine start/stop • Engine/generator protection (relay output to open GCB) • GCB operation (relay output to close GCB) • MCB operation (relay outputs to open and close MCB) • Mains failure detection with mains decoupling (GCB and/or MCB) • Auto mains failure operation (AMF)
GCB/GGB	A05	<p>GCB/GGB control (open/close)</p> <p>This application mode provides the following functions:</p> <ul style="list-style-type: none"> • Measuring of engine/generator parameters (i.e. voltage, frequency, current, power, coolant temperature, oil pressure, etc.) • Engine start/stop • Engine/generator protection (relay output to open GCB) • GCB operation (relay output to close GCB) • GGB operation (relay output to open and close the GGB) • Mains failure detection with mains decoupling (GCB)
GCB/GGB/MCB	A06	<p>GCB/GGB/MCB control (open/close)</p> <p>This application mode provides the following functions:</p> <ul style="list-style-type: none"> • Measuring of engine/generator parameters (i.e. voltage, frequency, current, power, coolant temperature, oil pressure, etc.) • Engine start/stop

Application mode	Symbol	Function
		<ul style="list-style-type: none"> • Engine/generator protection (relay output to open GCB) • GCB operation (relay output to close GCB) • GGB operation (relay output to open and close the GGB) • MCB operation (relay outputs to open and close the MCB) • Mains failure detection with mains decoupling (GCB/MCB) • Auto mains failure operation (AMF)
GCB/LSx	A07	<p>GCB/LSx control (open/close)</p> <p>This application mode provides the following functions:</p> <ul style="list-style-type: none"> • Measuring of engine/generator parameters (i.e. voltage, frequency, current, power, coolant temperature, oil pressure, etc.) • Engine start/stop • Engine/generator protection (relay output to open GCB) • GCB operation (relay output to close GCB) • Connection to LS-5 system, LS-5 runs as independent unit (Mode "LS5") • Auto mains failure operation (AMF) guided by LS-5 system <p>Note Unless otherwise noted, "LS-5", "LSx", "LS -6XT" and "easYgen LS-6XT" are used interchangeably in this document.</p>
GCB/L-MCB	A08	<p>GCB/L-MCB control (open/close)</p> <p>This application mode provides the following functions:</p> <ul style="list-style-type: none"> • Measuring of engine/generator parameters (i.e. voltage, frequency, current, power, coolant temperature, oil pressure, etc.) • Engine start/stop • Engine/generator protection (relay output to open GCB) • GCB operation (relay output to close GCB) • MCB operation via LS-5, LS-5 runs as slave unit (Mode "L-MCB") • Mains failure detection with mains decoupling via GCB or LS-5 (MCB) • Auto mains failure operation (AMF)
GCB/GGB/L-MCB	A09	<p>GCB/GGB/L-MCB control (open/close)</p> <p>This application mode provides the following functions:</p> <ul style="list-style-type: none"> • Measuring of engine/generator parameters (i.e. voltage, frequency, current, power, coolant temperature, oil pressure, etc.) • Engine start/stop • Engine/generator protection (relay output to open GCB) • GCB operation (relay output to close GCB) • GGB operation (relay output to open and close the GGB) • MCB operation via LS-5, LS-5 runs as slave unit (Mode "L-MCB") • Mains failure detection with mains decoupling via GCB or LS-5 (MCB) • Auto mains failure operation (AMF)
GCB/L-GGB	A10	<p>GCB/L-GGB control (open/close)</p> <p>This application mode provides the following functions:</p> <ul style="list-style-type: none"> • Measuring of engine/generator parameters (i.e. voltage, frequency, current, power, coolant temperature, oil pressure, etc.) • Engine start/stop • Engine/generator protection (relay output to open GCB) • GCB operation (relay output to close GCB) • GGB operation (relay output to open and close the GGB)

Application mode	Symbol	Function
		<ul style="list-style-type: none"> • Mains failure detection with mains decoupling via GCB or LS-5 (MCB) • Auto mains failure operation (AMF)
GCB/L-GGB/L-MCB	A11	<p>GCB/L-GGB/L-MCB control (open/close)</p> <p>This application mode provides the following functions:</p> <ul style="list-style-type: none"> • Measuring of engine/generator parameters (i.e. voltage, frequency, current, power, coolant temperature, oil pressure, etc.) • Engine start/stop • Engine/generator protection (relay output to open GCB) • GCB operation (relay output to close GCB) • GGB operation via LS-5, LS-5 runs as slave unit (Mode “L-GGB”) • MCB operation via LS-5, LS-5 runs as slave unit (Mode “L-MCB”) • Mains failure detection with mains decoupling via GCB or LS-5 (MCB) • Auto mains failure operation (AMF)
GCB/L-GGBMCB	A12	<p>GCB/L-GGBMCB control (open/close)</p> <p>This application mode provides the following functions:</p> <ul style="list-style-type: none"> • Measuring of engine/generator parameters (i.e. voltage, frequency, current, power, coolant temperature, oil pressure, etc.) • Engine start/stop • Engine/generator protection (relay output to open GCB) • GCB operation (relay output to close GCB) • GGB and MCB operation via LS-5x2, LS-5 runs as slave unit (Mode “L-GGBMCB”) • Mains failure detection with mains decoupling via GCB or LS-5x2 (GGB or MCB) • Auto mains failure operation (AMF)
GCB/GC	A13	<p>GCB/GGB/MCB (open/close)</p> <p>This application mode provides operation with Group Controller (GC) OR LSx the following functions:</p> <ul style="list-style-type: none"> • Measuring of engine/generator parameters (i.e. voltage, frequency, current, power, coolant temperature, oil pressure, etc.) • Engine start/stop • Engine/generator protection (relay output to open GCB) • GCB operation (relay output to close GCB) • Connection to LS5 system, LS5 runs as independent unit • Connection to GC system which is supporting different groups of generators • Auto mains failure operation (AMF) guided by LSx OR GC system

2.3 Operation Modes

The easYgen-3000XT offers four operation modes:

- AUTO
- MANUAL (MAN)
- TEST
- STOP

- ... and an internal (non) operating phase during starting the device itself

The plastic housing (HMI) version of the easYgen-3000XT enables to select an operation mode by pressing the according button at the front panel - if current settings allow this function.

For more information about the operation modes please see [↪ “5.2 Change Operating Modes”](#).

3 Installation

NOTICE!

! **Avoid electrostatic discharge!**

Before working with terminals please read and follow the instructions of chapter ["Electrostatic discharge"](#).

For CAN and RS485 shielded cabling, no more than 25 mm wiring exposed without shield coverage are allowed at terminal plug side.

3.1 Mount Unit (Sheet Metal Housing)

Dimensions

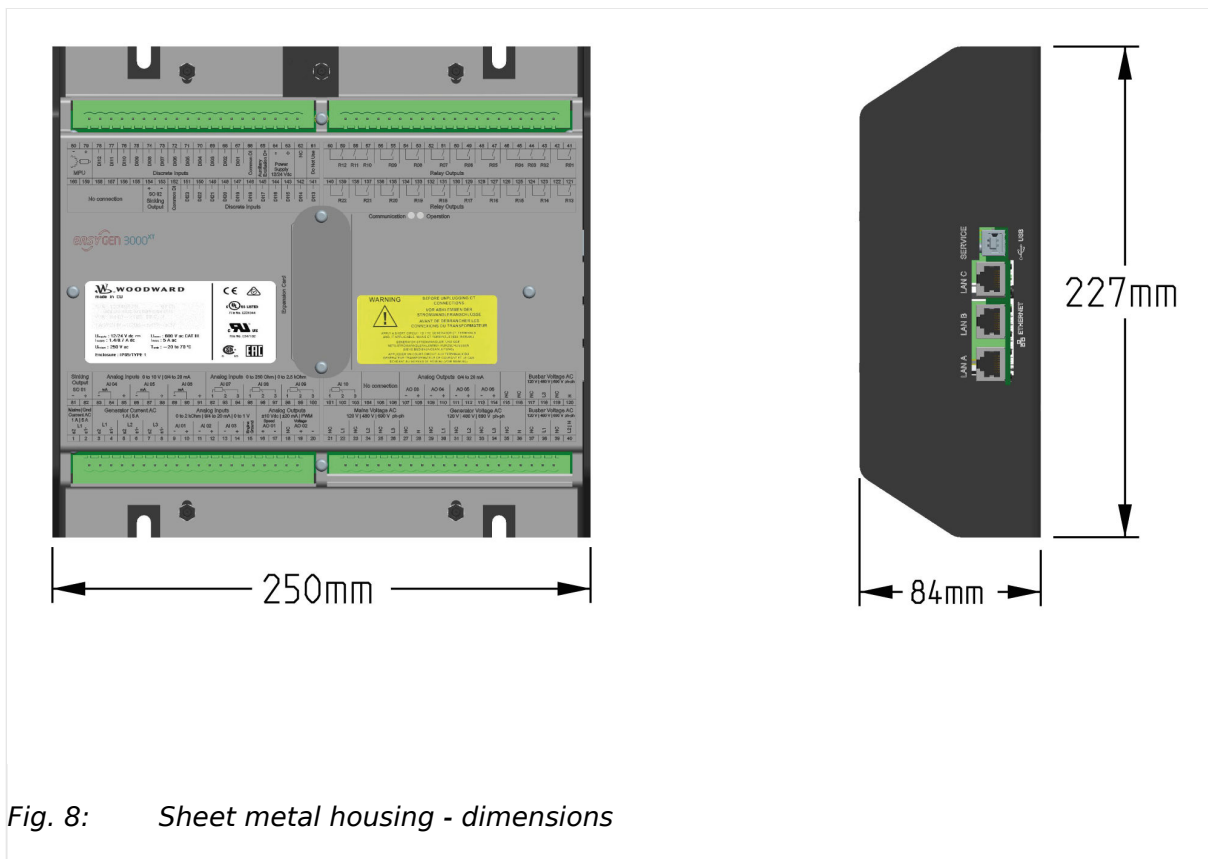

Fig. 8: Sheet metal housing - dimensions

Mounting into a cabinet

⚙

>

- Special tool: Torque screwdriver

Proceed as follows to install the unit using the screw kit:

3 Installation

3.1 Mount Unit (Sheet Metal Housing)

1. ▷

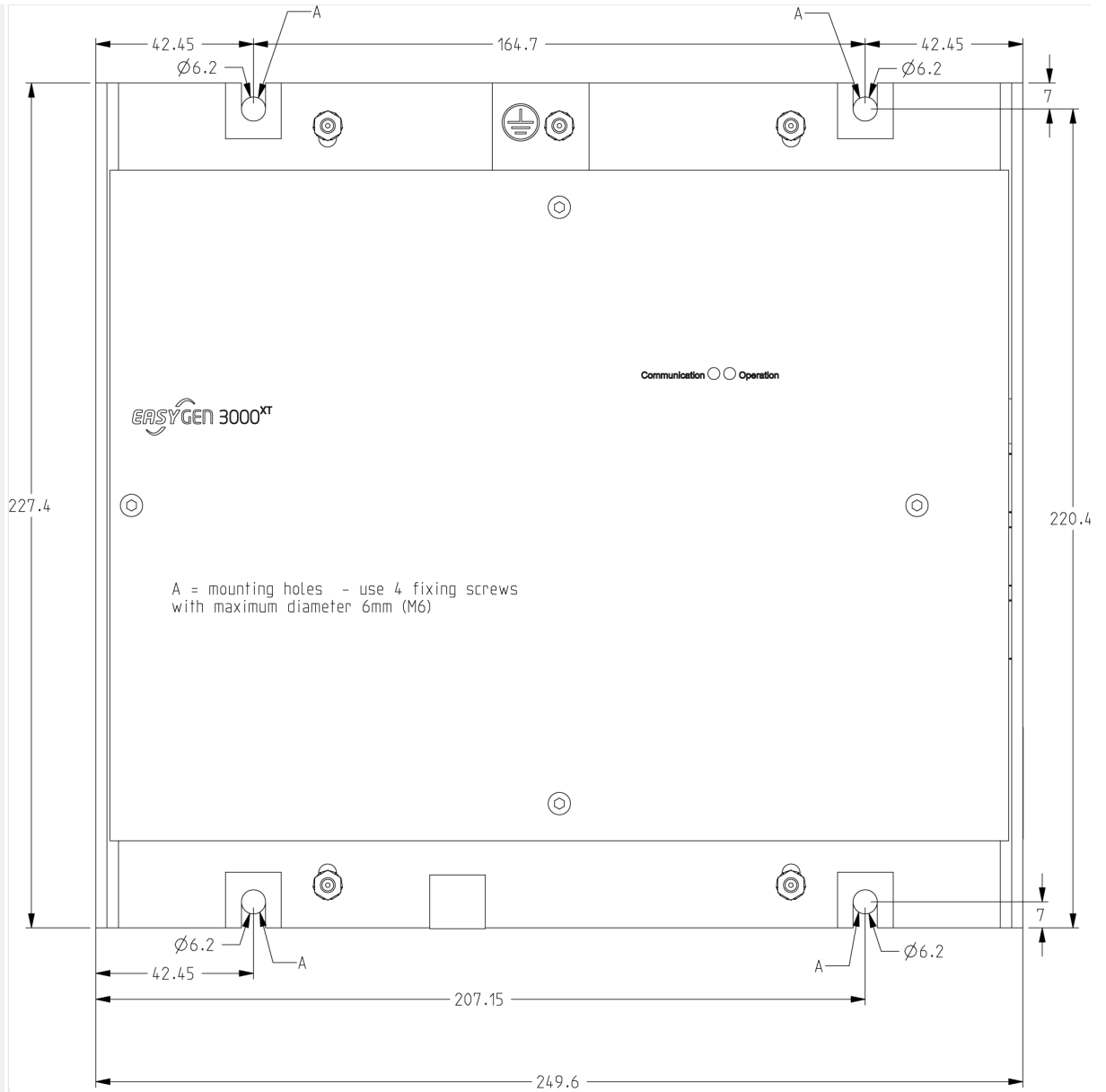

Fig. 9: Sheet metal housing - drill plan

Drill the holes according to the dimensions in Fig. 9 (dimensions shown in mm).

Ensure sufficient clearance for access to the terminals (top and bottom) and connectors located at the sides.

2. ▷ Mount the unit to the back panel and insert the screws.

3. ▷ Tighten the screws to a torque according to the quality class of the used screws.

Tighten the screws with a crosswise pattern to ensure even pressure distribution.

3.2 Mount Unit (Plastic Housing)

Mount the unit **either** using the clamp fasteners (↳ “3.2.1 Clamp Fastener Installation”) **or** the screw kit (↳ “3.2.2 Screw Kit Installation”).



- Don't drill holes if you want to use the clamp fasteners. If the holes are drilled into the panel, the clamp fasteners cannot be used anymore.
- In order to enhance the protection to IP 66, fasten the unit with the screw kit instead of the clamp fastener hardware.

Dimensions

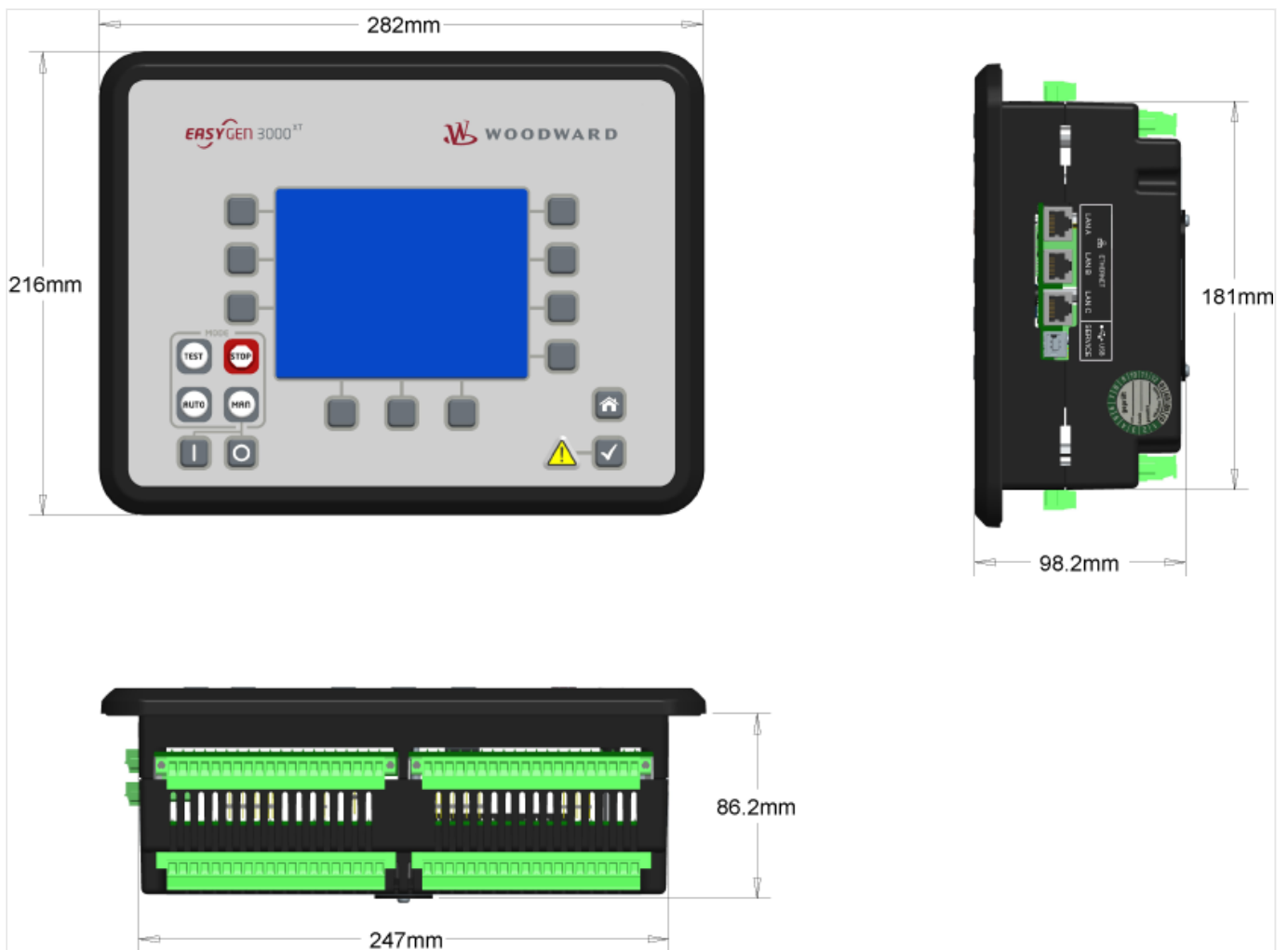

Fig. 10: Plastic housing - dimensions

Panel cutout

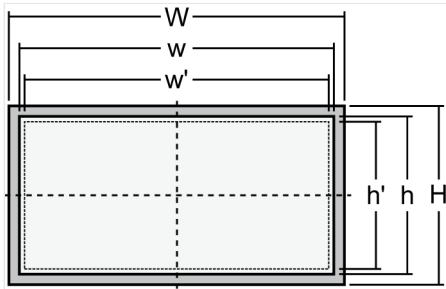



Fig. 11: Cutout schematic

Measure	Description			Tolerance
H	Height	Total	216 mm	—
h		Panel cutout	183 mm	+ 1.0 mm
h'		Housing dimension	181 mm	
W	Width	Total	282 mm	—
w		Panel cutout	249 mm	+ 1.1 mm
w'		Housing dimension	247 mm	
	Depth	Total	98.2 mm	—

 The maximum permissible corner radius is 4 mm.

3.2.1 Clamp Fastener Installation



>

1. ▷

For installation into a door panel with the fastening clamps, proceed as follows:

1. ▷ Cut out the panel according to the dimensions in  Fig. 11.

 Don't drill the holes if you want to use the clamp fasteners. If the holes are drilled into the panel, the clamp fasteners cannot be used anymore!

2. ▷

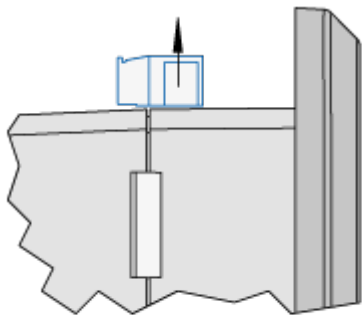

Fig. 12: Remove terminals

Loosen the wire connection terminal screws on the back of the unit and remove the wire connection terminal strip if required.

3. ▷



Fig. 13: Insert screws in clamps

Insert the four clamping screws into the clamp inserts from the shown side (↳ Fig. 13; opposite the nut insert) until they are almost flush. Do not completely insert the screws into the clamp inserts.

4. ▷

Insert the unit into the panel cutout. Verify that the unit fits correctly in the cutout. If the panel cutout is not big enough, enlarge it accordingly.

5. ▷

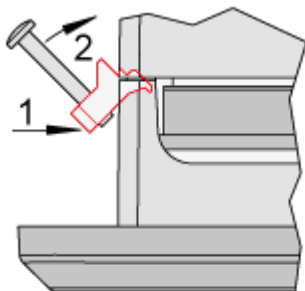

Fig. 14: Attach clamp inserts

Re-install the clamp inserts by tilting the insert to a 45° angle. (↳ Fig. 14/1) Insert the nose of the insert into the slot on the side of the housing. (↳ Fig. 14/2) Raise the clamp insert so that it is parallel to the control panel.

6. ▷

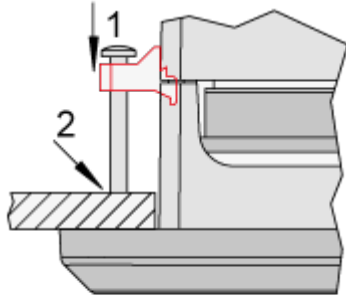

Fig. 15: Tighten clamping screws

Tighten the clamping screws (↳ Fig. 15/1) until the control unit is secured to the control panel (↳ Fig. 15/2). Over tightening of these screws may result in the clamp inserts or the housing breaking. Do not exceed the recommended tightening torque of 0.1 Nm.

7. ▷

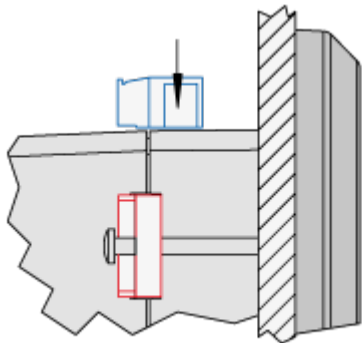

Fig. 16: Reattach terminals

Reattach the wire connection terminal strip (↳ Fig. 16) and secure them with the side screws.

3.2.2 Screw Kit Installation



The housing is equipped with 12 nut inserts (↳ Fig. 17), which must all be tightened properly to achieve the required degree of protection.

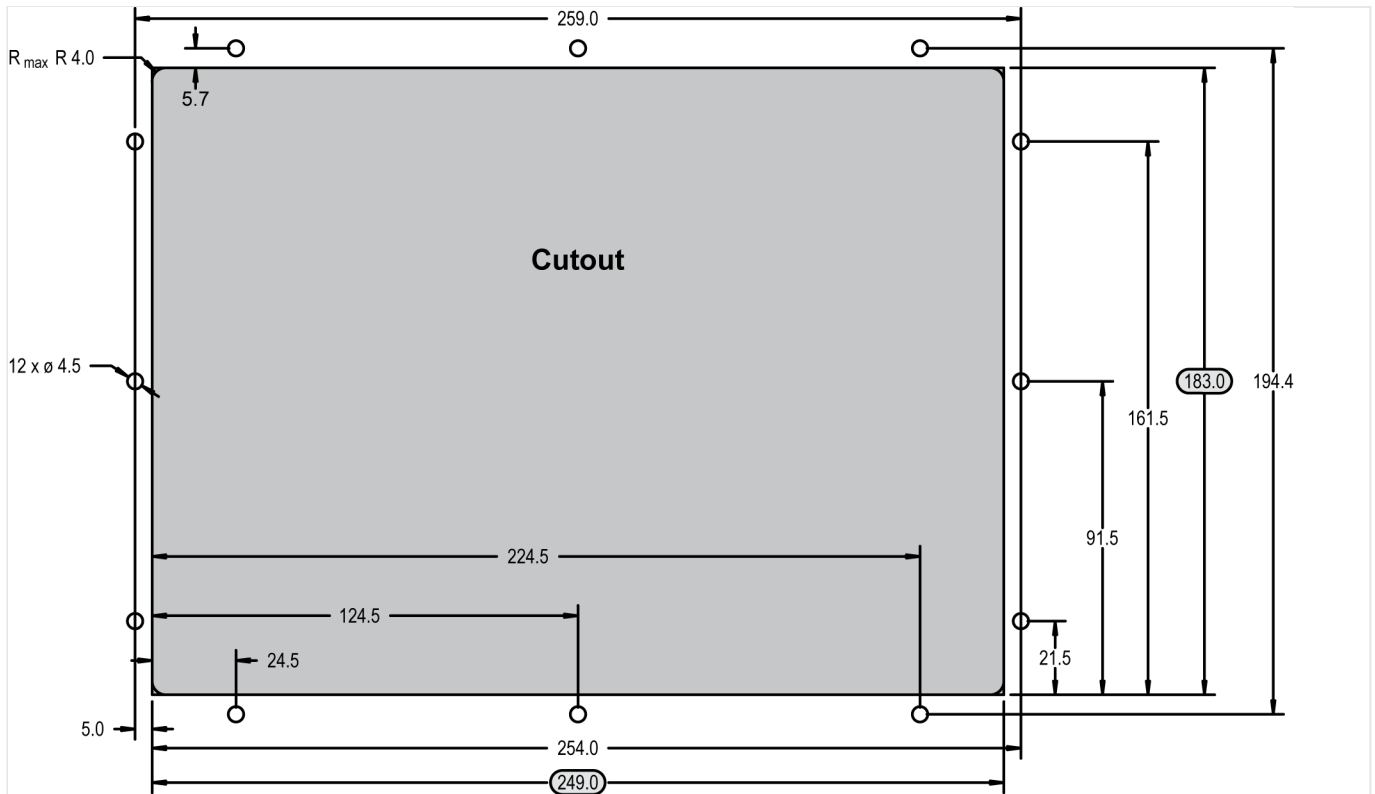

Fig. 17: Plastic housing - drill plan



- Special tool: Torque screwdriver

Proceed as follows to install the unit using the screw kit:

1. ▷ Cut out the panel and drill the holes according to the dimensions in [Fig. 17](#) (dimensions shown in mm).
2. ▷ Insert the unit into the panel cutout. Verify that the unit fits correctly in the cutout. If the panel cutout is not big enough, enlarge it accordingly.
3. ▷ Insert the screws and tighten to 0.6 Nm (5.3 pound inches) of torque.



Tighten the screws with a crosswise pattern to ensure even pressure distribution.



If the thickness of the panel sheet exceeds 2.5 mm, be sure to use screws with a length exceeding the panel sheet thickness by 4 mm.

3.3 Setup Connections

NOTICE!

 **Avoid electrostatic discharge!**

Before working with terminals please read and follow the instructions of chapter [↪](#) “Electrostatic discharge”.

For CAN and RS485 shielded cabling, no more than 25 mm wiring exposed without shield coverage are allowed at terminal plug side.

General notes

NOTICE!

 **Malfunctions due to literal use of example values**

All technical data and ratings indicated in this chapter are merely listed as examples. Literal use of these values does not take into account all actual specifications of the control unit as delivered.

- For definite values please refer to chapter [↪](#) “8.1 Technical Data”.

Wire sizes

 Field wiring shall be made with use of cables which have temperature rating not less than 90 °C.

AWG	mm ²	AWG	mm ²	AWG	mm ²	AWG	mm ²	AWG	mm ²	AWG	mm ²
30	0.05	21	0.38	14	2.5	4	25	3/0	95	600MCM	300
28	0.08	20	0.5	12	4	2	35	4/0	120	750MCM	400
26	0.14	18	0.75	10	6	1	50	300MCM	150	1000MCM	500
24	0.25	17	1.0	8	10	1/0	55	350MCM	185		
22	0.34	16	1.5	6	16	2/0	70	500MCM	240		

Table 1: Conversion chart - wire sizes

3.3.1 Terminal Allocation

NOTICE!



Avoid electrostatic discharge!

Before working with terminals please read and follow the instructions of chapter [“Electrostatic discharge”](#).

For CAN and RS485 shielded cabling, no more than 25 mm wiring exposed without shield coverage are allowed at terminal plug side.

The device terminals 1 to 80 are allocated similarly for all easYgen-3000XT and all housing variants. Terminals 81 to 160 additionally are allocated similarly for:

- Plastic housing - for easYgen-3500XT-P2 and easYgen-3500XT-P2-LT and
- Sheet metal housing - for easYgen-3400XT-P2

The max. possible conductor cross-section of the terminals used is $A_{\max} = 2.5 \text{ mm}^2$!



LT Variant description

The temperature range is the only difference between standard plastic housing and LT variant.

The manual is describing plastic housing and metal housing variant. Describing the plastic housing means both standard and LT variant - if not, it is mentioned!

3 Installation
3.3.1 Terminal Allocation

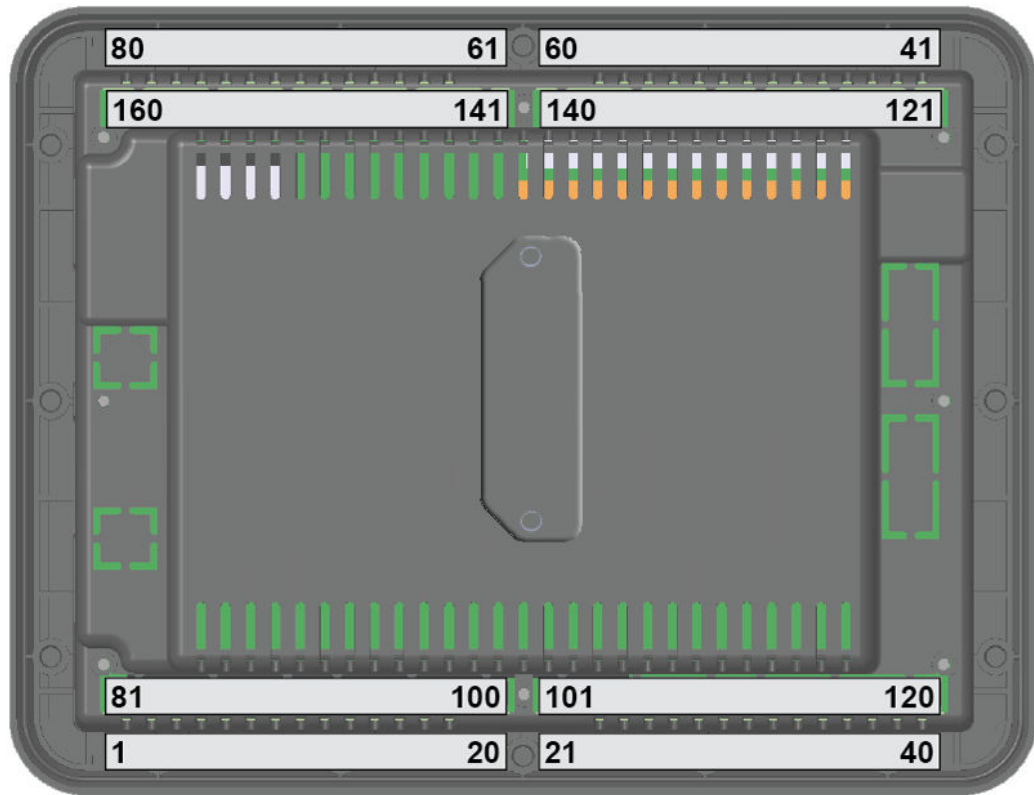

Fig. 18: Terminals easYgen-3500XT-P2(-LT) plastic housing

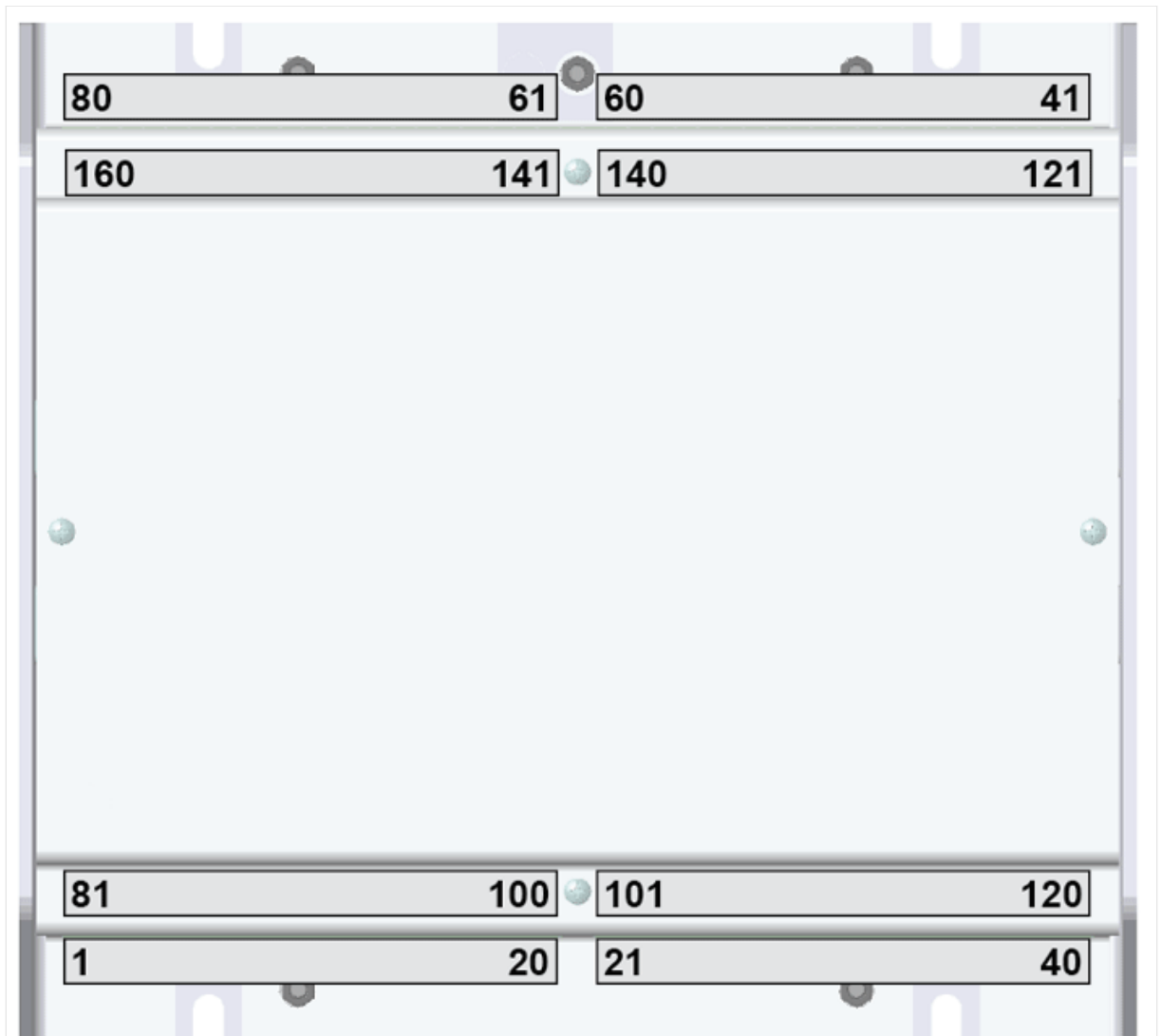

Fig. 19: Terminals easYgen-3400XT-P2 sheet metal housing

3.3.2 Wiring Diagram



The Protective Earth terminal 61 is not connected on the sheet metal housing.

- Use the protective earth (PE) connector located at the bottom center of the sheet metal housing instead.



Common terminal for AC measurement voltages

Mains, generator, and busbar voltage measuring terminals no longer differentiate with separate terminals for each voltage range.



General recommendations

Ensure appropriate cable cross sections following the local standards and restrictions.

The maximum cable cross section of the terminal blocks is 2.5 mm².

For every type of signal lines like power supply, DI, DO, AI, AO, MPU:

- Return line has to be close to forward signal line.
- Use cables instead of single wires.
 - In case of using single wires please do at least one twist per meter to keep wires together closely.

Plastic housing variants:

- Rout all cables connected to terminal blocks **away** from back cover.

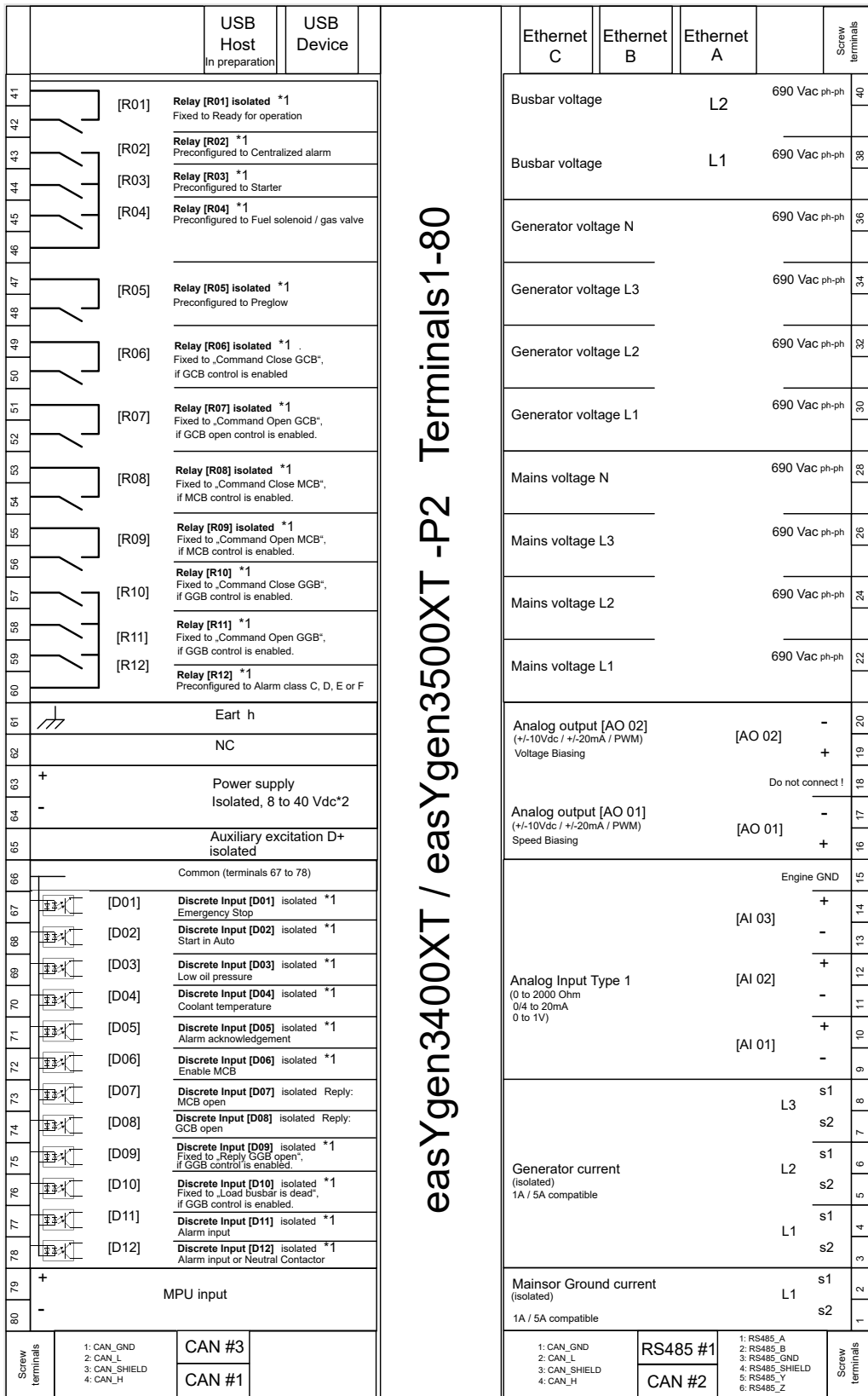

Subject to technical modifications

*1 configurable via LogicsManager

easYgen-3000XT Series Wiring DiagramPCB1

Fig. 20: Wiring diagram 1(2) easYgen-3400XT/3500XT-P2 (-LT)

Pin 61 Metal housing: don't use; Plastic housing with HMI/display: Earth/ground

3 Installation

3.3.2 Wiring Diagram

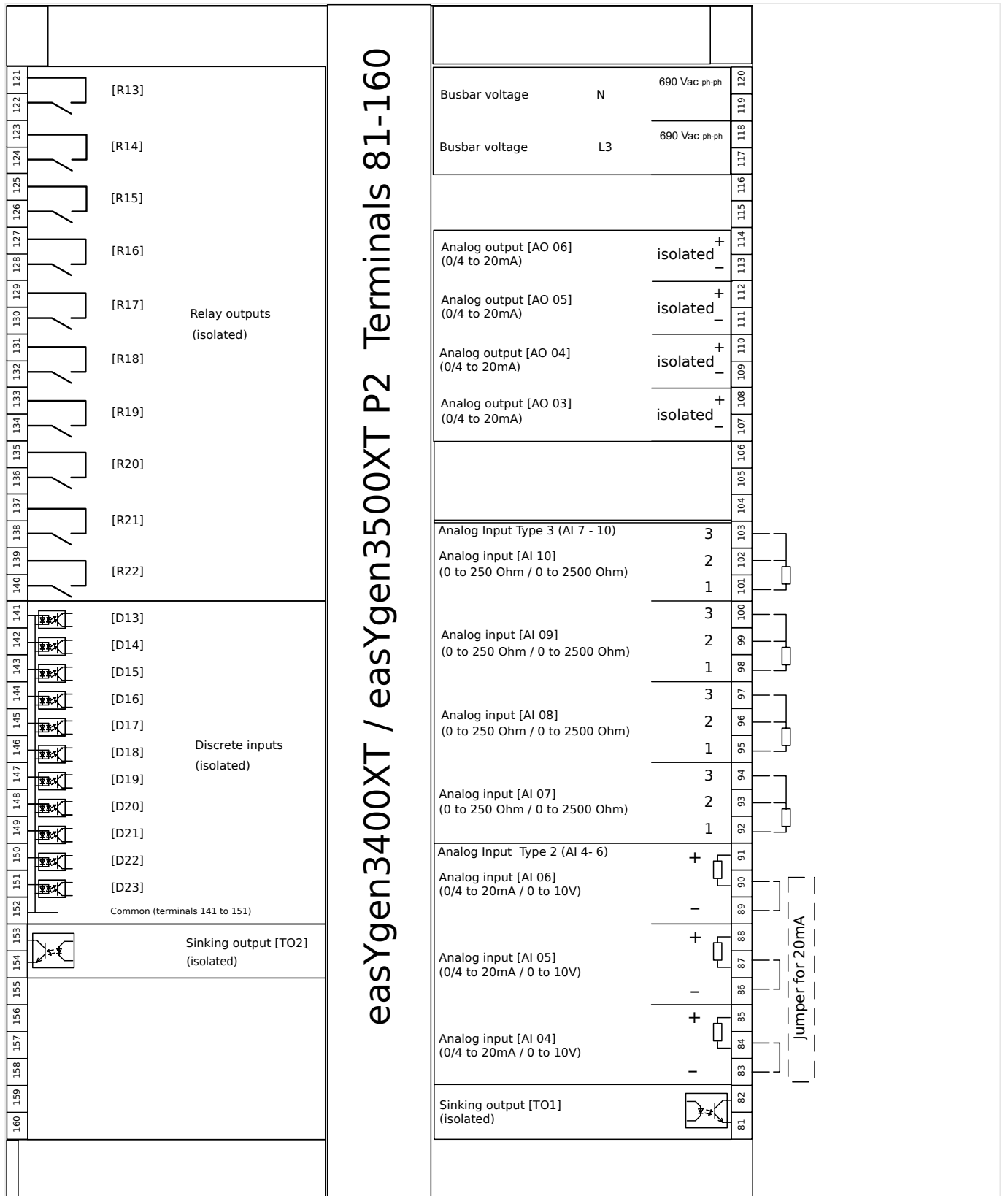

Fig. 21: Wiring diagram 2(2) easYgen-3400XT/3500XT-P2 (-LT)

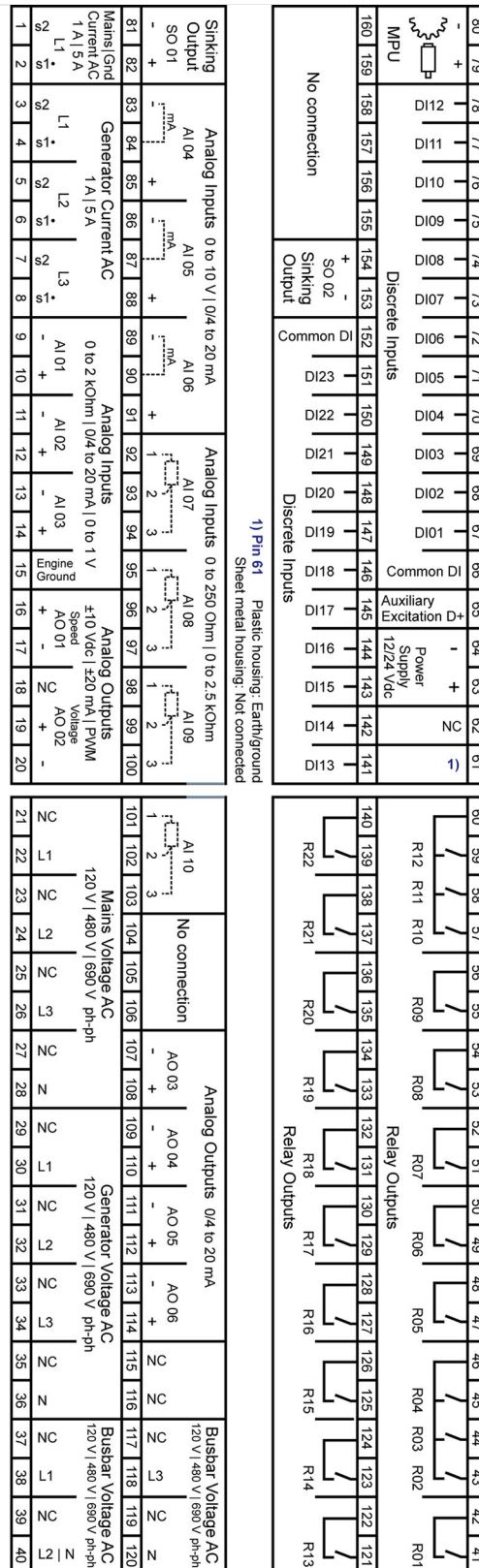

Fig. 22: Label/print easYgen-3400XT/3500XT-P2(-LT) wiring

- 1) Pin 61: Metal housing: don't use
Plastic housing with HMI/display: Earth/ground

3.3.3 Power Supply

General notes

WARNING!



Risk of electric shock - plastic housing

- Connect Protective Earth (PE) to the unit to avoid the risk of electric shock.
Setup the connection using screw-plug-terminal 61.
- The conductor providing the connection must have a wire larger than or equal to 2.5 mm² (14 AWG). The connection must be performed properly.

WARNING!



Risk of electric shock - sheet metal housing

- Connect Protective Earth (PE) to the unit to avoid the risk of electric shock.
Use the protective earth (PE) connector located at the bottom center of the sheet metal housing.
- The conductor providing the connection must have a wire larger than or equal to 2.5 mm² (14 AWG). The cable length should be as short as possible.
- The connection must be performed properly.

WARNING!



Permissible differential voltage

The maximum permissible differential voltage between terminal 64 (B-) and terminal 61 (PE) is 100 V_{RMS}. On engines where a direct connection between battery minus and PE is not possible, it is recommended to use an isolated external power supply if the differential voltage between battery minus and PE exceeds 100 V_{RMS}.



Woodward strictly recommends to use a power supply that is fulfilling the SELV restrictions (SELV = separated or safety extra-low voltage, see IEC)



Woodward recommends to use one of the following slow-acting protective devices in the supply line to terminal 63:

- Fuse NEOZED D01 6A or equivalent **or**
 - Miniature Circuit Breaker 6A / Type C
- (for example: ABB type: S271C6 or equivalent)



Power ON

With power ON the easYgen-3000XT device is monitoring self preparation by some display on screen and button illumination. HOME screen shows the device is working.

Schematic and terminals

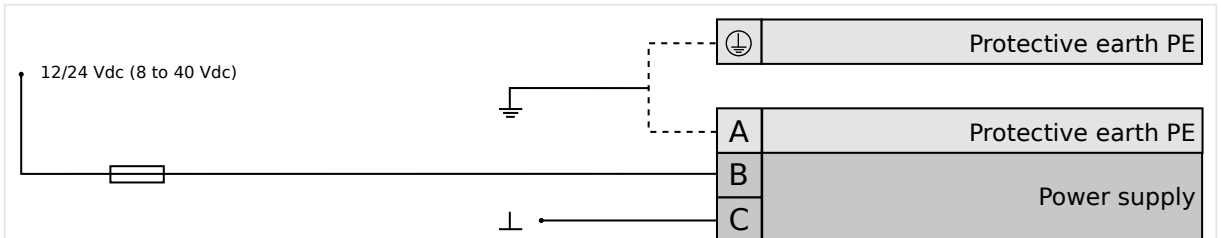

Fig. 23: Power supply - wiring

Terminal		Description
A	61	PE (protective earth) - plastic housing ONLY
B	63	12/24Vdc (8 to 40.0 Vdc)
C	64	0 Vdc

Table 2: Power supply - terminal assignment

Characteristics

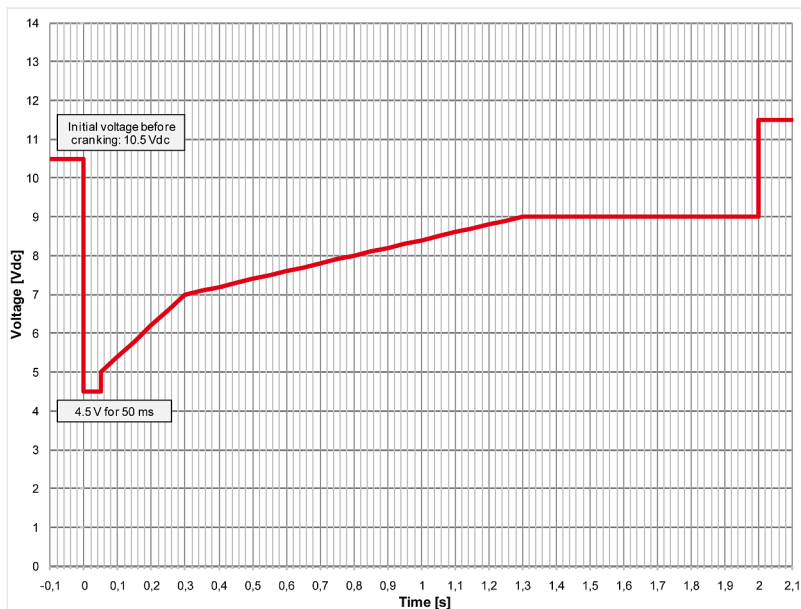



Fig. 24: Power supply - crank waveform

3.3.4 Charging Alternator

General notes

 The charging alternator D+ acts as an pre-exciting output during the engine start-up. During regular operation, it acts as an input for monitoring the charging voltage.

Schematic and terminals

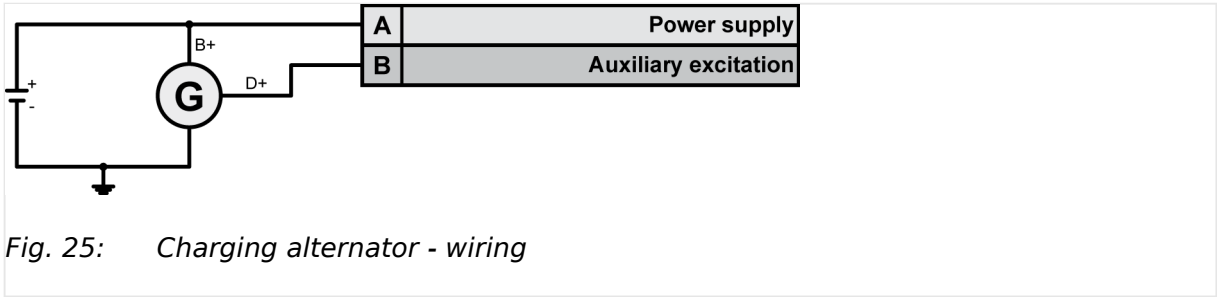



Fig. 25: Charging alternator - wiring

Terminal		Description
A	63	Battery B+ (8 to 40.0 Vdc SELV)
B	65	Auxiliary excitation (D+) output

Table 3: Charging alternator - terminal assignment

3.3.5 Voltage Measuring

General notes

 Woodward recommends protecting the voltage measuring inputs with slow-acting fuses rated for 2 to 6 A.

The wide range terminals allow several voltages. The current voltage (range) of the application must be "told" to the genset controller device. Settings are described in chapter [4.6 Configure Measurement](#).

NOTICE!

 The maximum permissible voltage against ground connected on the easYgen is 600 Volt. This is to consider if phase voltages are grounded.

3.3.5.1 Generator Voltage

General notes



The voltage measuring inputs for 120 V, 480 V, and 690 V are using the same terminals 30 to 36. The current voltage range must be selected by the corresponding settings via HMI and/or ToolKit.



Parameter 1800 ("Gen. PT secondary rated volt.") must be configured to the correct value to ensure proper measurement.

Schematic and terminals

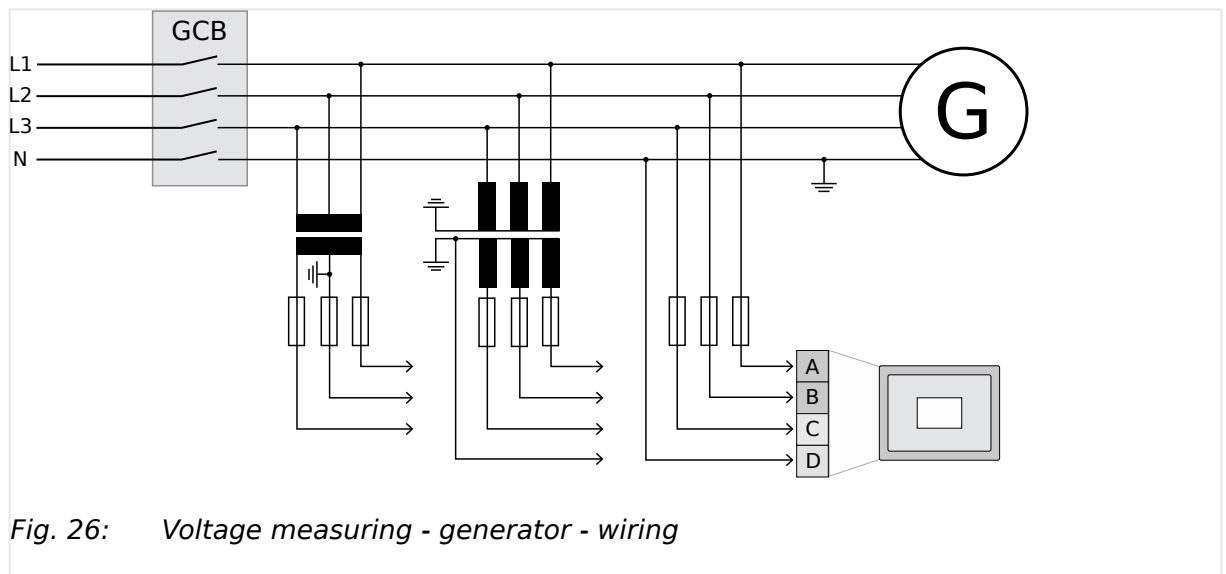

Fig. 26: Voltage measuring - generator - wiring

Measuring input / Phase	Terminal	
Generator voltage - L1	A	30
Generator voltage - L2	B	32
Generator voltage - L3	C	34
Generator voltage - N	D	36

Table 4: Voltage measuring - generator - terminal assignment

3.3.5.1.1 Parameter Setting '3Ph 4W OD' (3-phase, 4-wire, Open delta)

Generator windings

A generator system that is connected to the load through a 3-phase, 4-wire connection but have the device wired for a 3-phase, 3-wire installation may have the L2 phase grounded on the secondary side. In this application the device will be configured for 3-phase, 4-wire OD for correct power measurement.

3 Installation

3.3.5.1.1 Parameter Setting '3Ph 4W OD' (3-phase, 4-wire, Open delta)

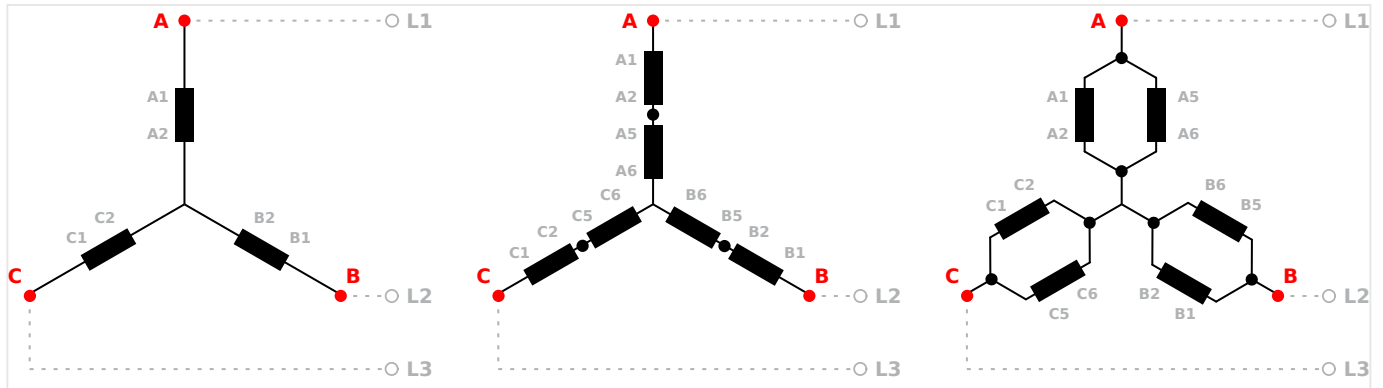

Fig. 27: Generator windings - 3Ph 4W OD

Measuring inputs

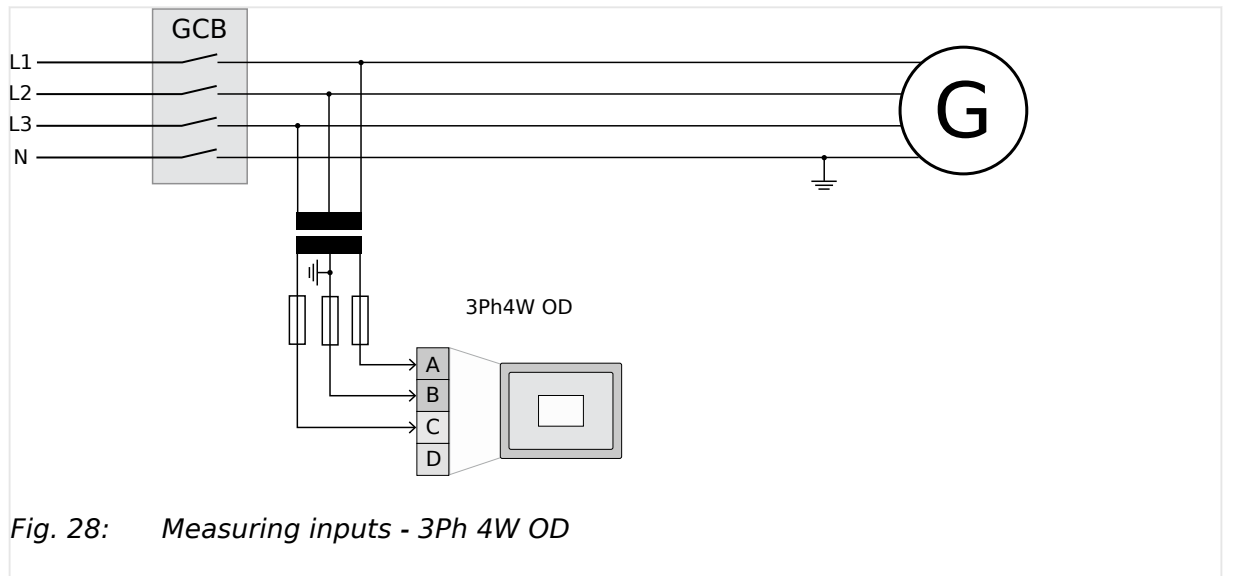

Fig. 28: Measuring inputs - 3Ph 4W OD

Terminal assignment

Measuring input / Phase	Terminal	
Generator voltage - L1	A	30
Generator voltage - L2	B	32
Generator voltage - L3	C	34
Generator voltage - N	-/-	

Table 5: Generator terminal assignment 3Ph 4W OD

3.3.5.1.2 Parameter Setting '3Ph 4W' (3-phase, 4-wire)

Generator windings

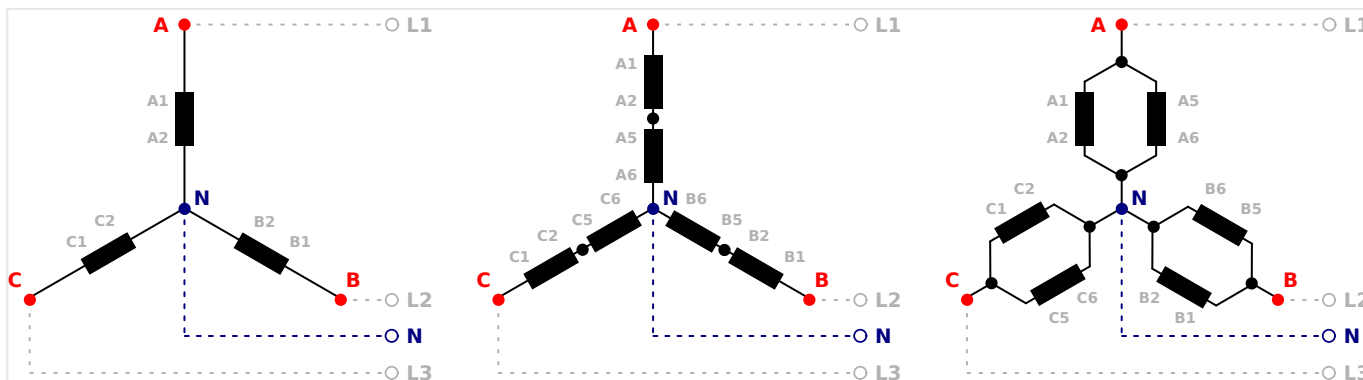

Fig. 29: Generator windings - 3Ph 4W

Measuring inputs

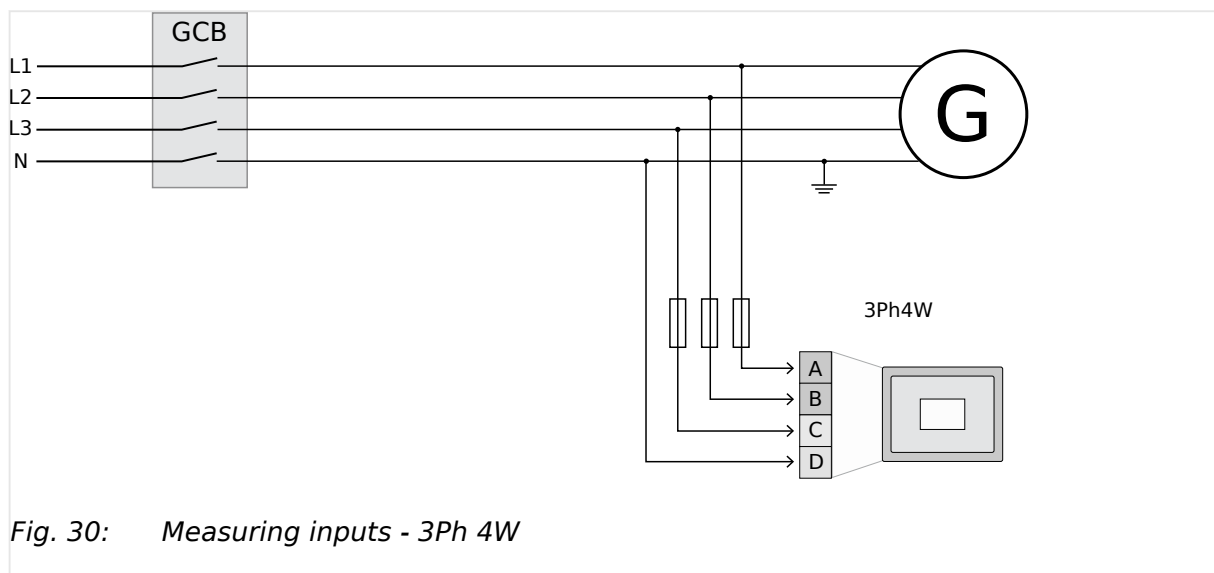

Fig. 30: Measuring inputs - 3Ph 4W

Terminal assignment

Measuring input / Phase	Terminal	
Generator voltage - L1	A	30
Generator voltage - L2	B	32
Generator voltage - L3	C	34
Generator voltage - N	D	36

Table 6: Generator terminal assignment 3Ph 4W

3 Installation

3.3.5.1.3 Parameter Setting '3Ph 3W' (3-phase, 3-wire)

3.3.5.1.3 Parameter Setting '3Ph 3W' (3-phase, 3-wire)

Generator windings

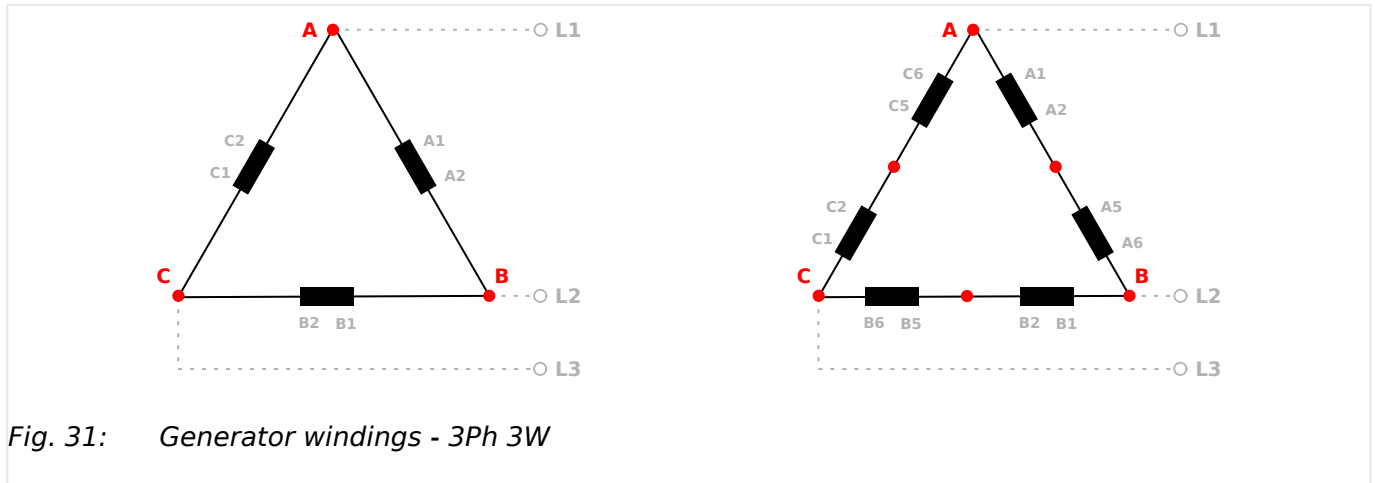

Fig. 31: Generator windings - 3Ph 3W

Measuring inputs

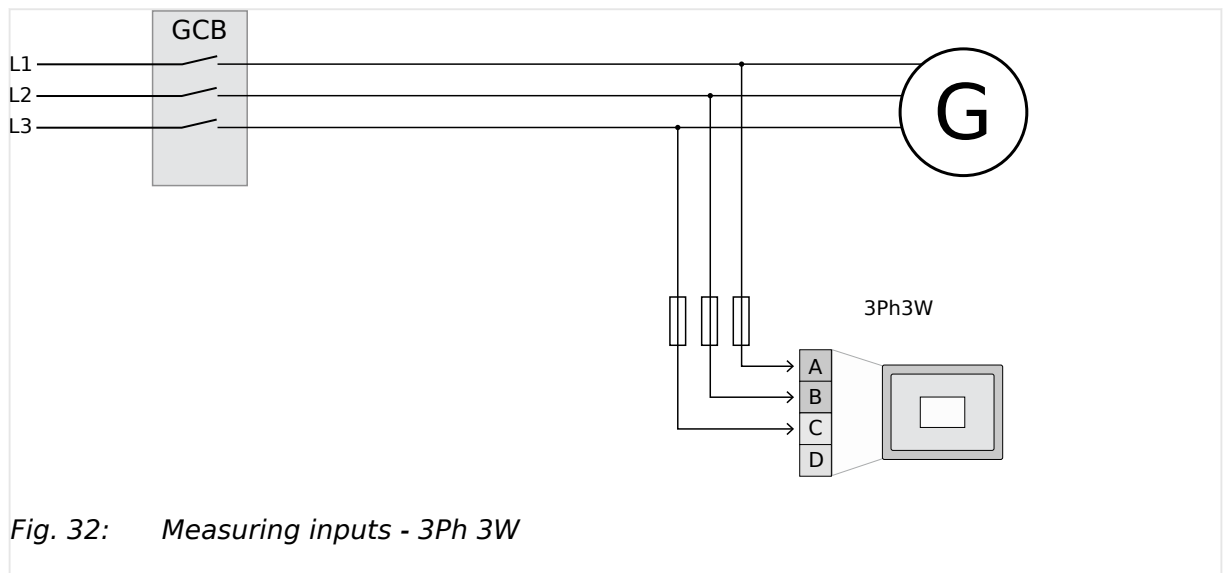

Fig. 32: Measuring inputs - 3Ph 3W

Terminal assignment

Measuring input / Phase	Terminal	
Generator voltage - L1	A	30
Generator voltage - L2	B	32
Generator voltage - L3	C	34
-/-	-/-	36

Table 7: Generator terminal assignment 3Ph 3W

3.3.5.1.4 Parameter Setting '1Ph 3W' (1-phase, 3-wire)

Generator windings

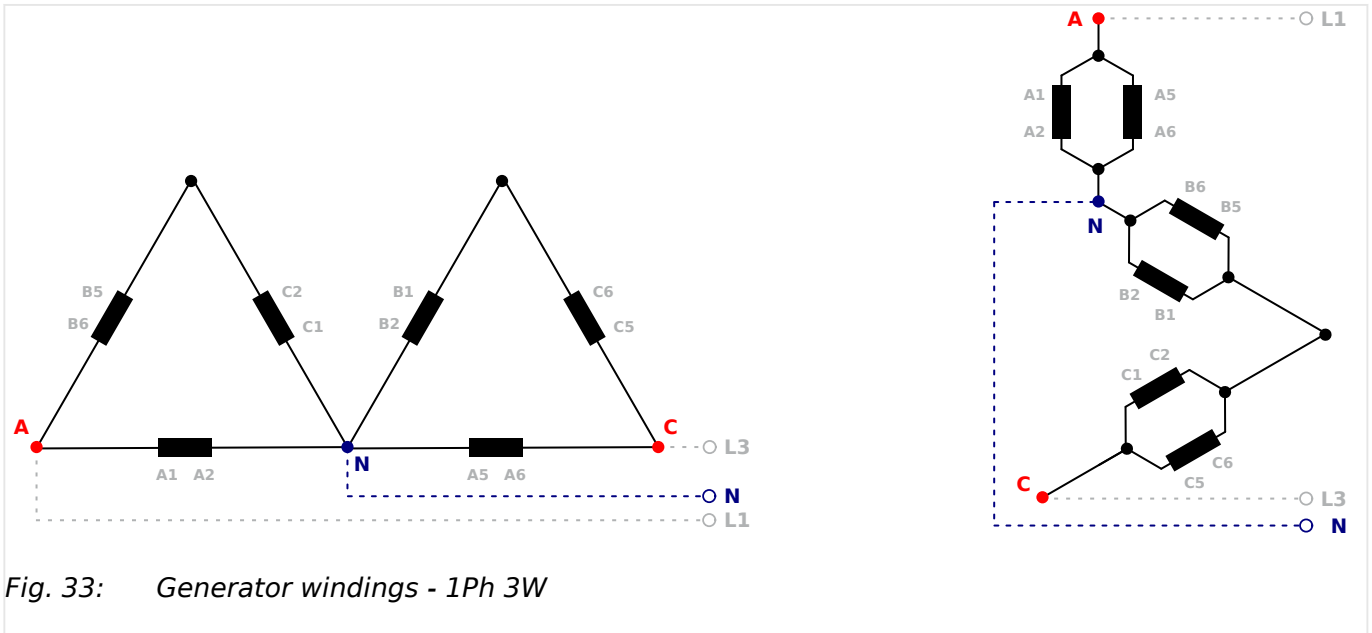

Fig. 33: Generator windings - 1Ph 3W

Measuring inputs

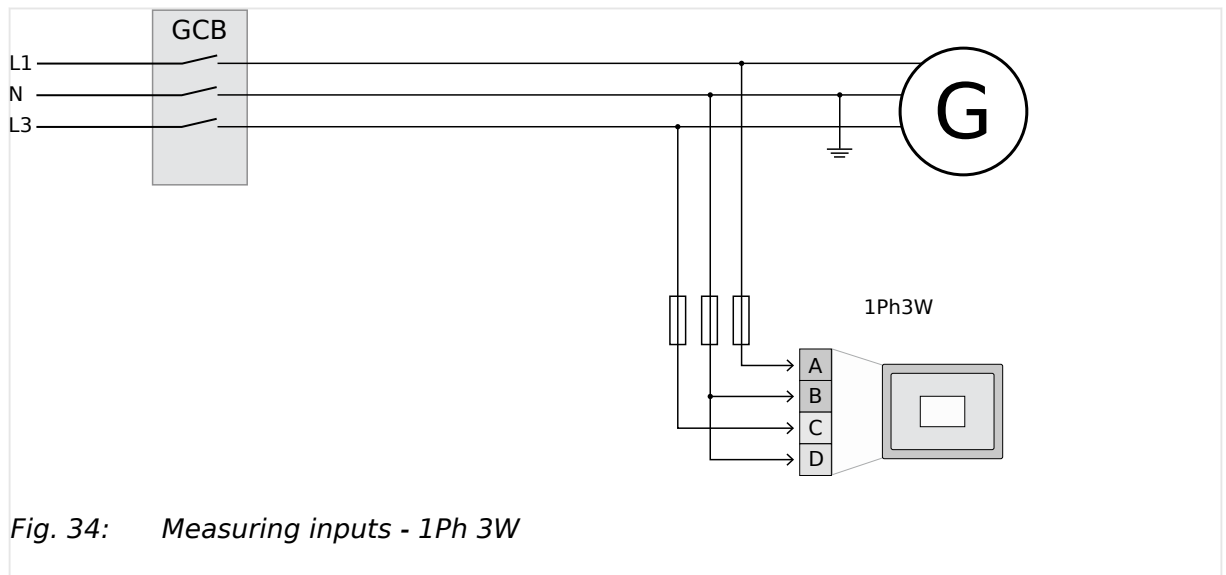

Fig. 34: Measuring inputs - 1Ph 3W

Terminal assignment

Measuring input / Phase	Terminal	
Generator voltage - L1	A	30
Generator voltage - L3	C	34
Generator voltage - N	D	36
	B	32

Table 8: Generator terminal assignment 1Ph 3W

3 Installation

3.3.5.1.5 Parameter Setting '1Ph 2W' (1-phase, 2-wire)

3.3.5.1.5 Parameter Setting '1Ph 2W' (1-phase, 2-wire)

i

The 1-phase, 2-wire measurement may be performed **phase-neutral** or **phase-phase**.

- Please note to configure and wire the easYgen consistently.

3.3.5.1.5.1 '1Ph 2W' Phase-Neutral Measuring

Generator windings

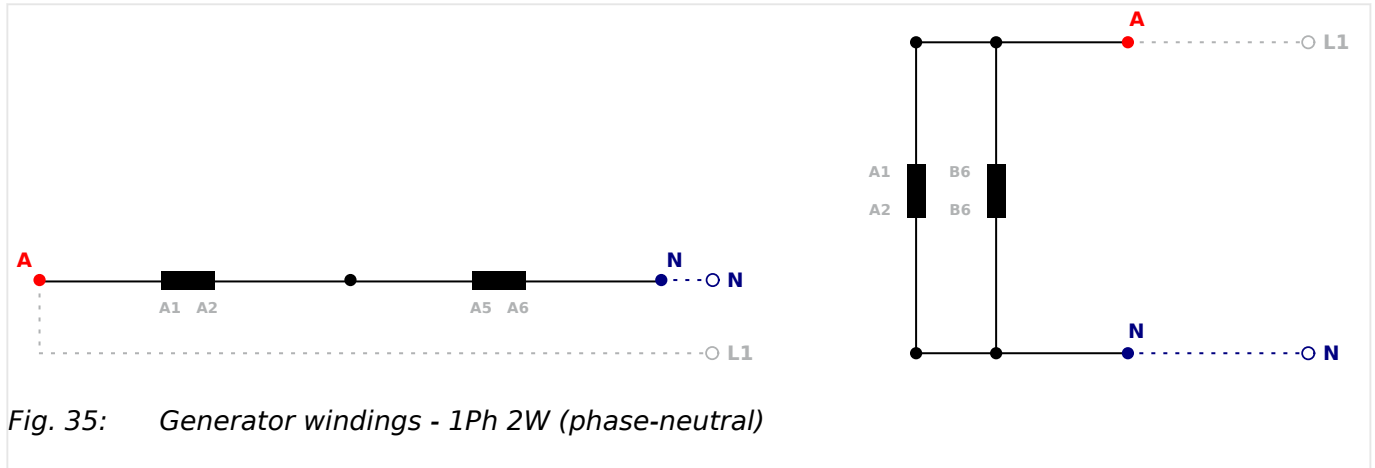

Fig. 35: Generator windings - 1Ph 2W (phase-neutral)

Measuring inputs

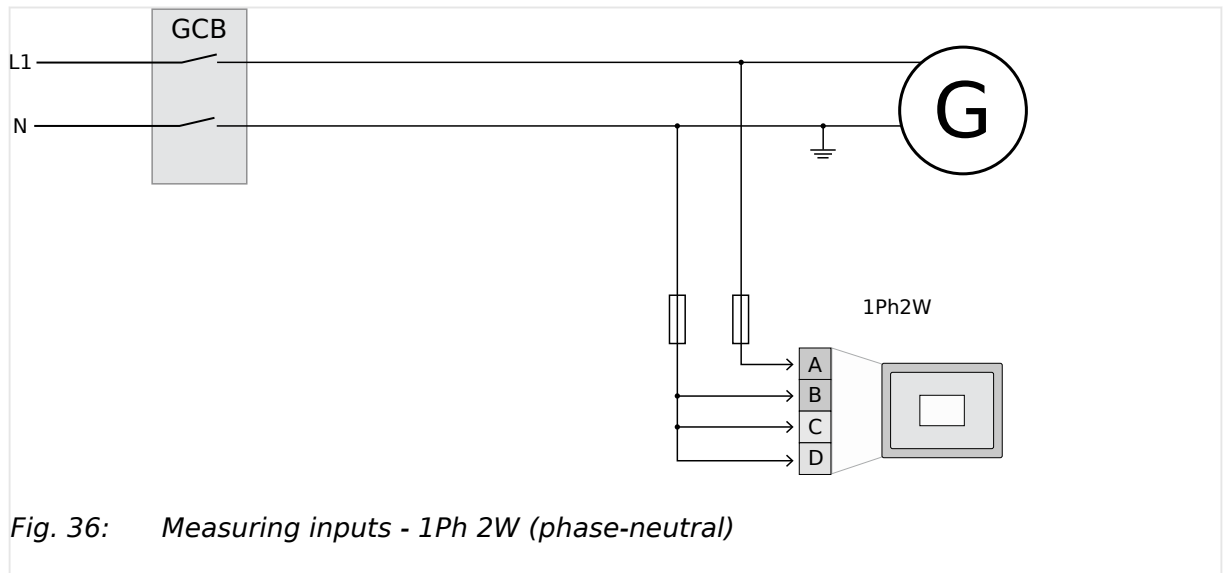



Fig. 36: Measuring inputs - 1Ph 2W (phase-neutral)

Terminal assignment

Measuring input / Phase	Terminal	
Generator voltage - L1	A	30
Generator voltage - N	B	32
	C	34

Measuring input / Phase	Terminal	
	D	36

Table 9: Generator terminal assignment 1Ph 2W (phase neutral)



Never configure the busbar measurement for phase-neutral, if the other systems like mains and generator are configured as 3ph 3W or 3ph 4W without being the neutral in the middle of the triangle.

The phase angle for synchronization would be not correct.

3.3.5.1.5.2 '1Ph 2W' Phase-Phase Measuring

Generator windings

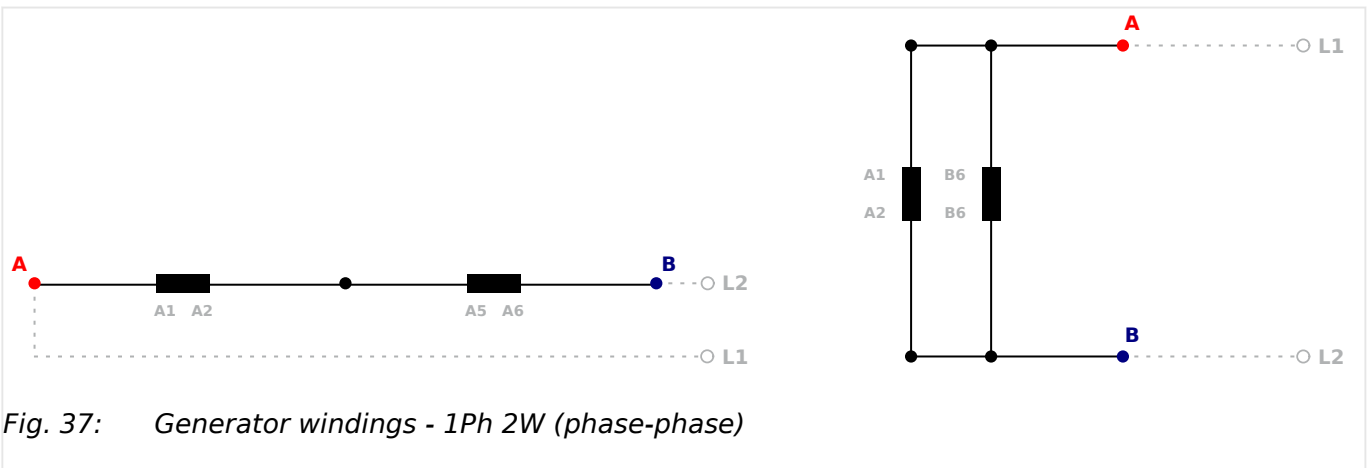

Fig. 37: Generator windings - 1Ph 2W (phase-phase)

Measuring inputs

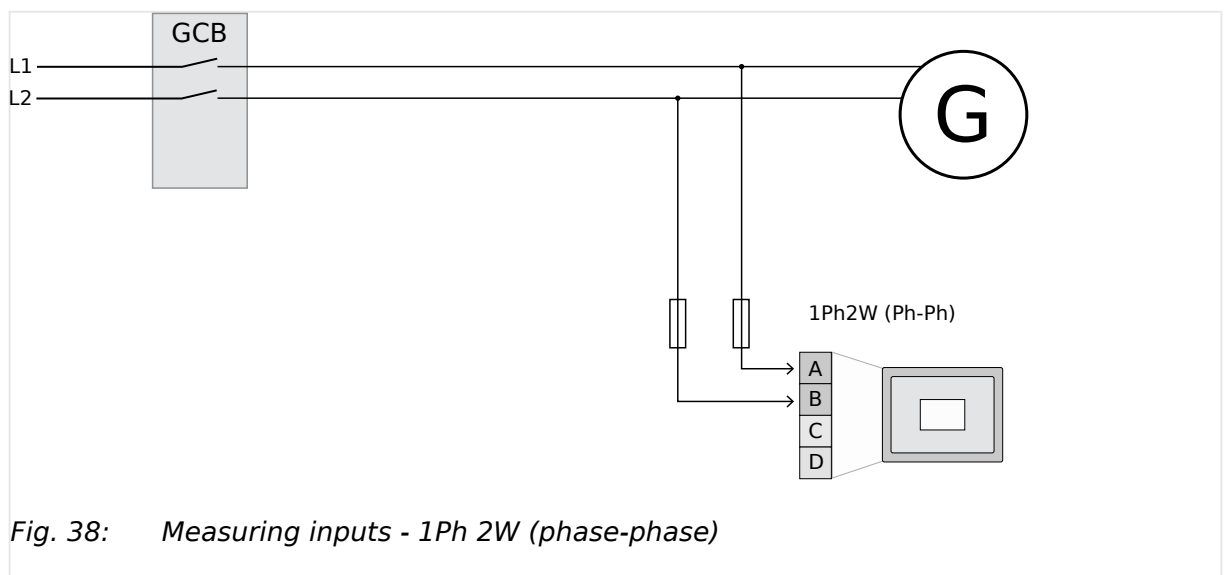

Fig. 38: Measuring inputs - 1Ph 2W (phase-phase)

Terminal assignment

Measuring input / Phase	Terminal	
Generator voltage - L1	A	30
Generator voltage - L2	B	32
Generator voltage - L3	-/-	
-/-	-/-	34, 36

Table 10: Generator terminal assignment 1Ph 2W (phase-phase)

3.3.5.2 Mains Voltage

General notes



The voltage measuring inputs for 120 V, 480 V, and 690 V are using the same terminals 22 to 28. The current voltage range must be selected by the corresponding settings via HMI and/or ToolKit.



Parameter 1803 ("Mains PT secondary rated volt.") must be configured with the correct value to ensure proper measurement.



If the easYgen is intended to be operated in parallel with the mains, the mains voltage measuring inputs must be connected.

If an external mains decoupling is performed, jumpers between busbar and mains voltage measuring inputs may be installed.

Schematic and terminals

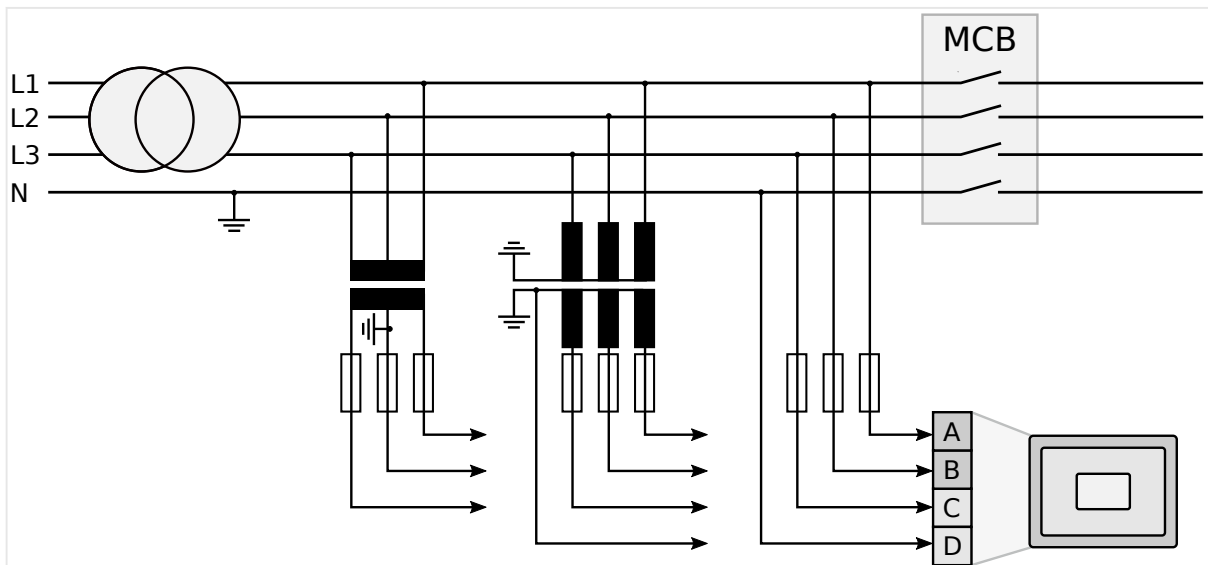

Fig. 39: Voltage measuring - mains - wiring

Measuring input / Phase	Terminal	
Mains voltage - L1	A	22
Mains voltage - L2	B	24
Mains voltage - L3	C	26
Mains voltage - N	D	28

Table 11: Voltage measuring - mains - terminal assignment

3.3.5.2.1 Parameter Setting '3Ph 4W' (3-phase, 4-wire)

Mains windings

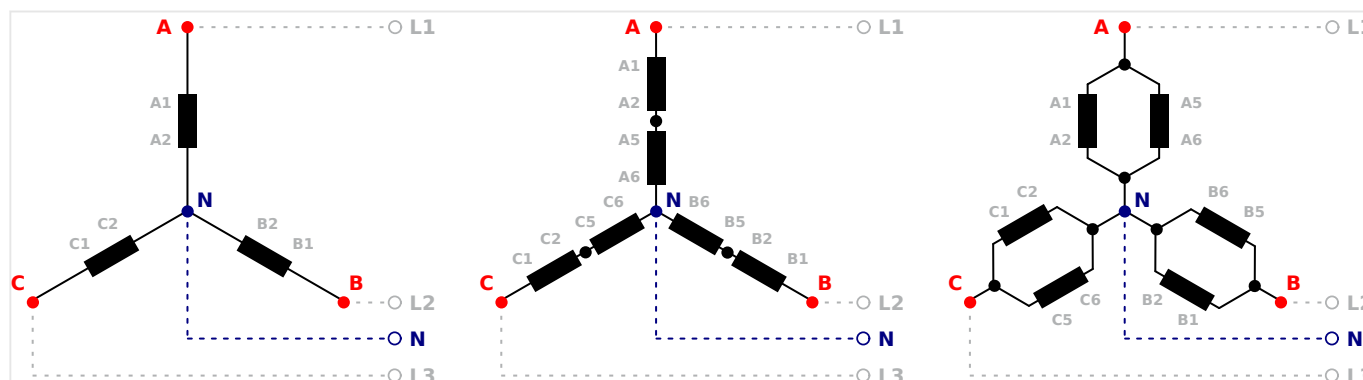

Fig. 40: Mains windings - 3Ph 4W

Measuring inputs

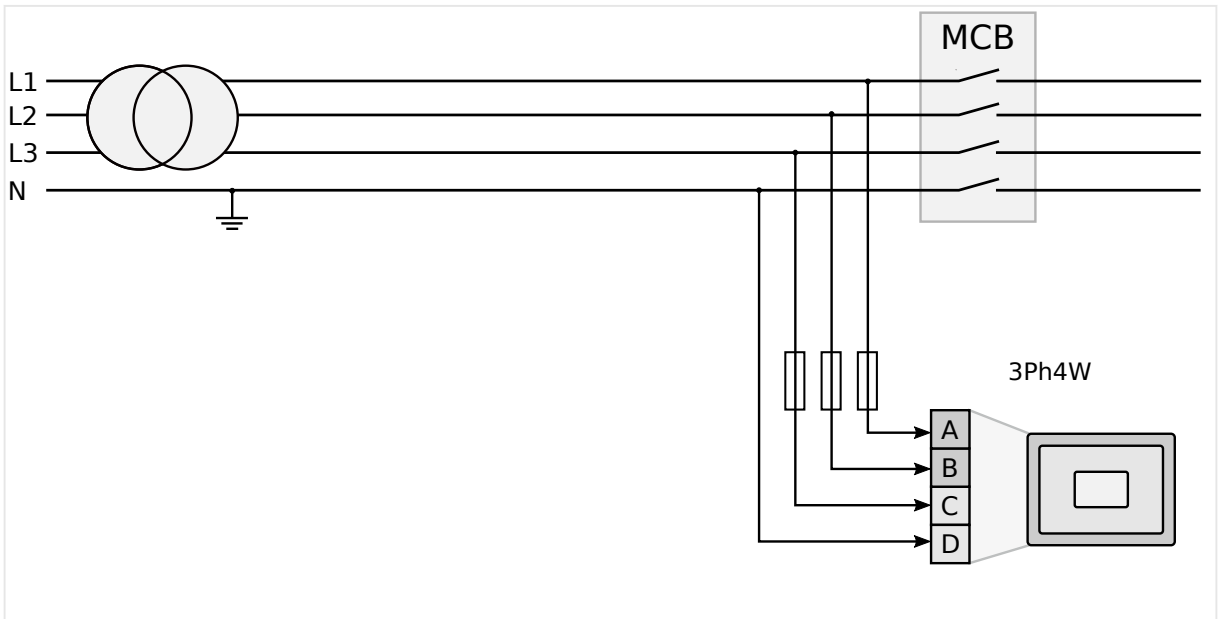

Fig. 41: Measuring inputs - 3Ph 4W

Terminal assignment

Measuring input / Phase	Terminal	
Mains voltage - L1	A	22
Mains voltage - L2	B	24
Mains voltage - L3	C	26
Mains voltage - N	D	28

Table 12: Mains terminal assignment 3Ph 4W

Mains windings

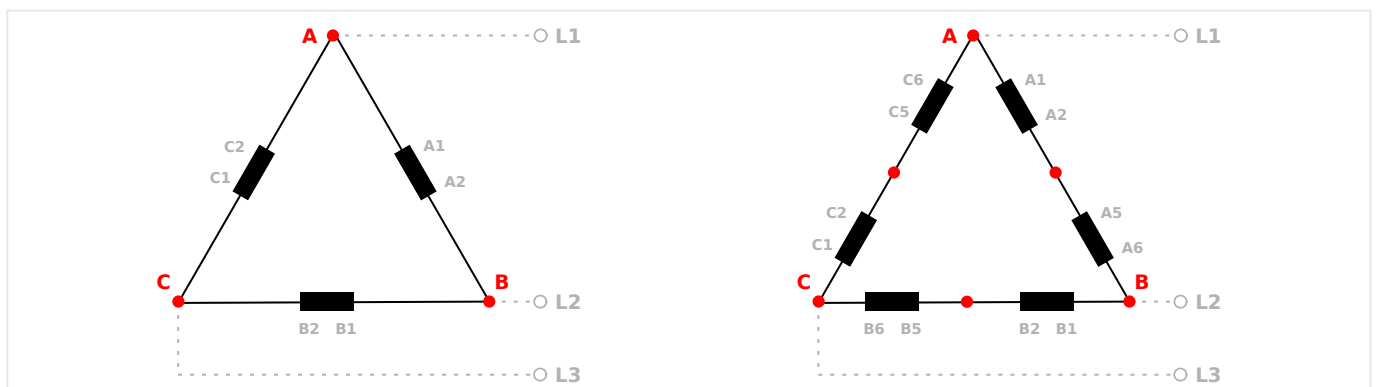

Fig. 42: Mains windings - 3Ph 3W

Measuring inputs

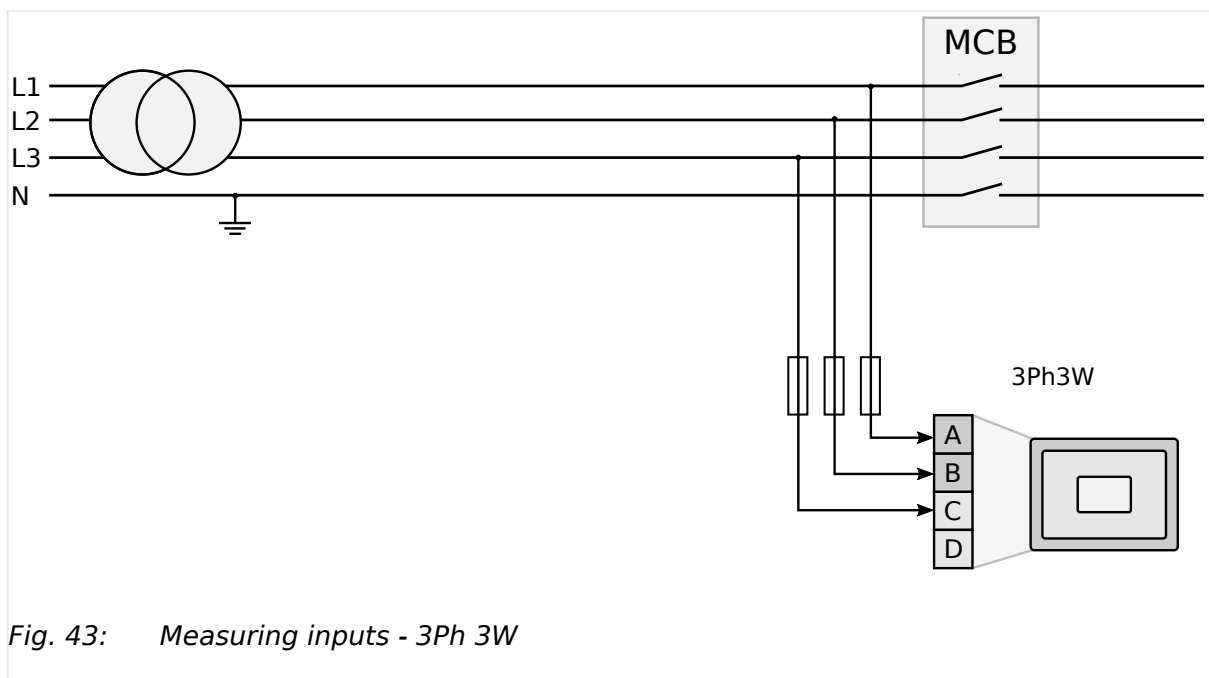

Fig. 43: Measuring inputs - 3Ph 3W

Terminal assignment

Measuring input / Phase	Terminal	
Mains voltage - L1	A	22
Mains voltage - L2	B	24
Mains voltage - L3	C	26
-/-	-/-	28

Table 13: Mains terminal assignment 3Ph 3W

3.3.5.2.3 Parameter Setting '1Ph 3W' (1-phase, 3-wire)

Mains windings

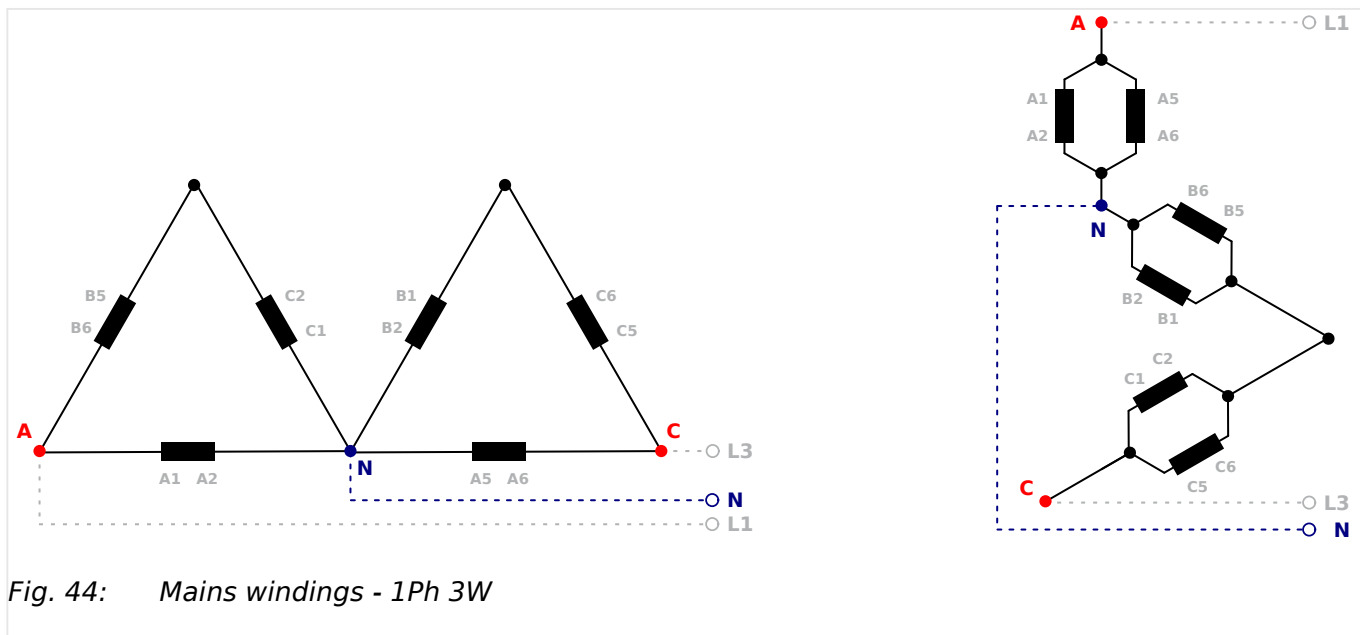

Fig. 44: Mains windings - 1Ph 3W

Measuring inputs

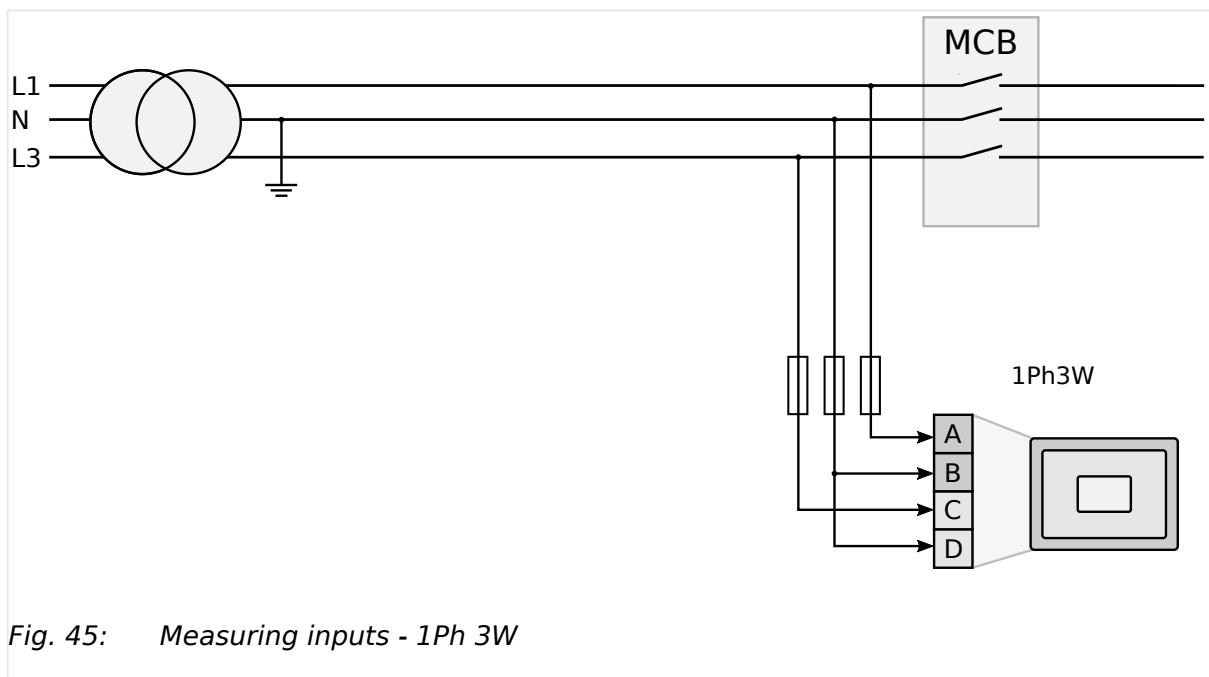

Fig. 45: Measuring inputs - 1Ph 3W

Terminal assignment

Measuring input / Phase	Terminal	
Mains voltage - L1	A	22
Mains voltage - L3	C	26
Mains voltage - N	B	24

Measuring input / Phase	Terminal	
	D	28

Table 14: Mains terminal assignment 1Ph 3W

3.3.5.2.4 Parameter Setting '1Ph 2W' (1-phase, 2-wire)



The 1-phase, 2-wire measurement may be performed **phase-neutral** or **phase-phase**.

- Please note to configure and wire the easYgen consistently.

3.3.5.2.4.1 '1Ph 2W' Phase-Neutral Measuring

Mains windings

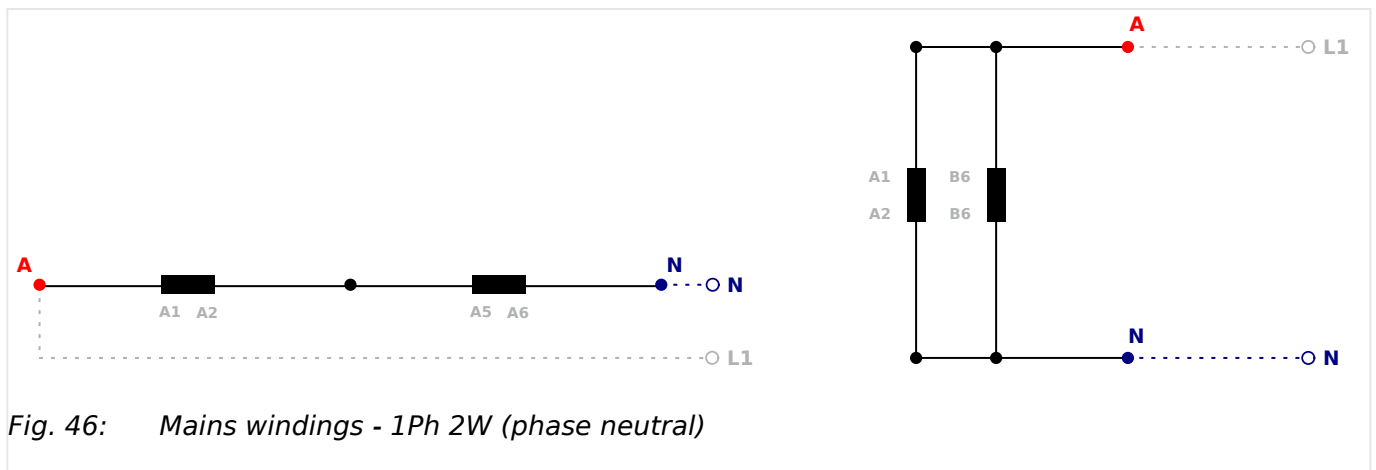

Fig. 46: Mains windings - 1Ph 2W (phase neutral)

Measuring inputs

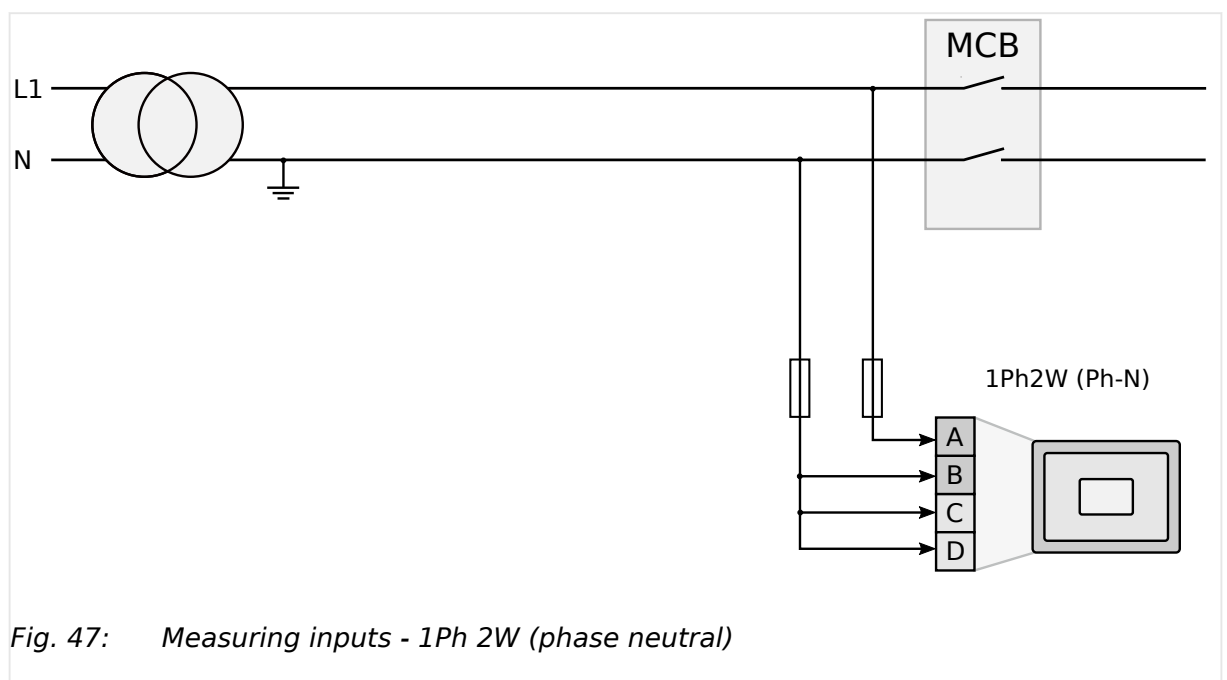

Fig. 47: Measuring inputs - 1Ph 2W (phase neutral)

Terminal assignment

Measuring input / Phase	Terminal	
Mains voltage - L1	A	22
Mains voltage - N	B	24
	C	26
	D	28

Table 15: Mains terminal assignment 1Ph 2W phase neutral

3.3.5.2.4.2 '1Ph 2W' Phase-Phase Measuring

Mains windings

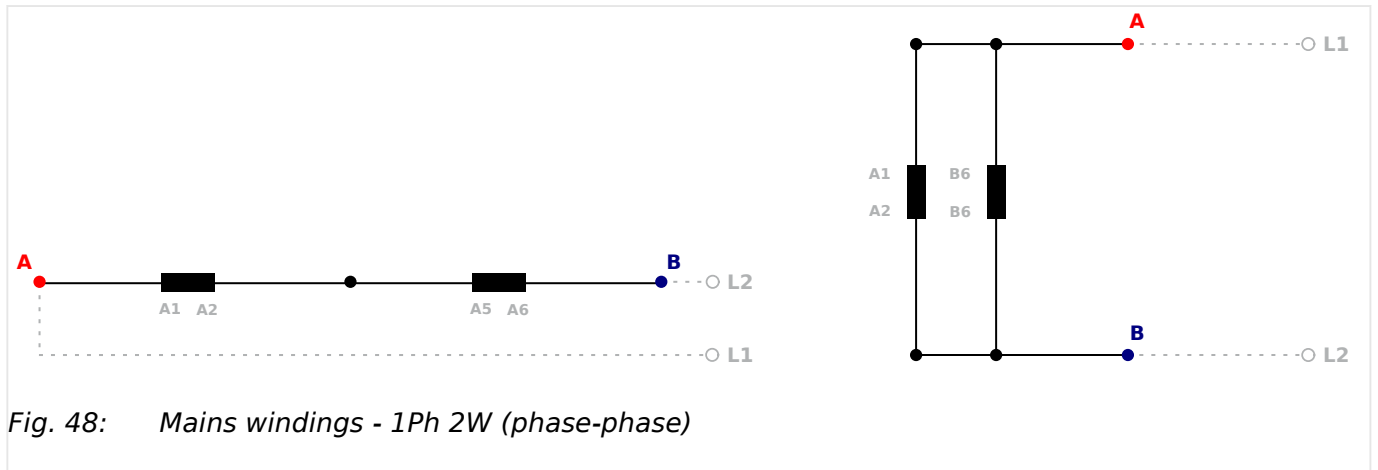

Fig. 48: Mains windings - 1Ph 2W (phase-phase)

Measuring inputs

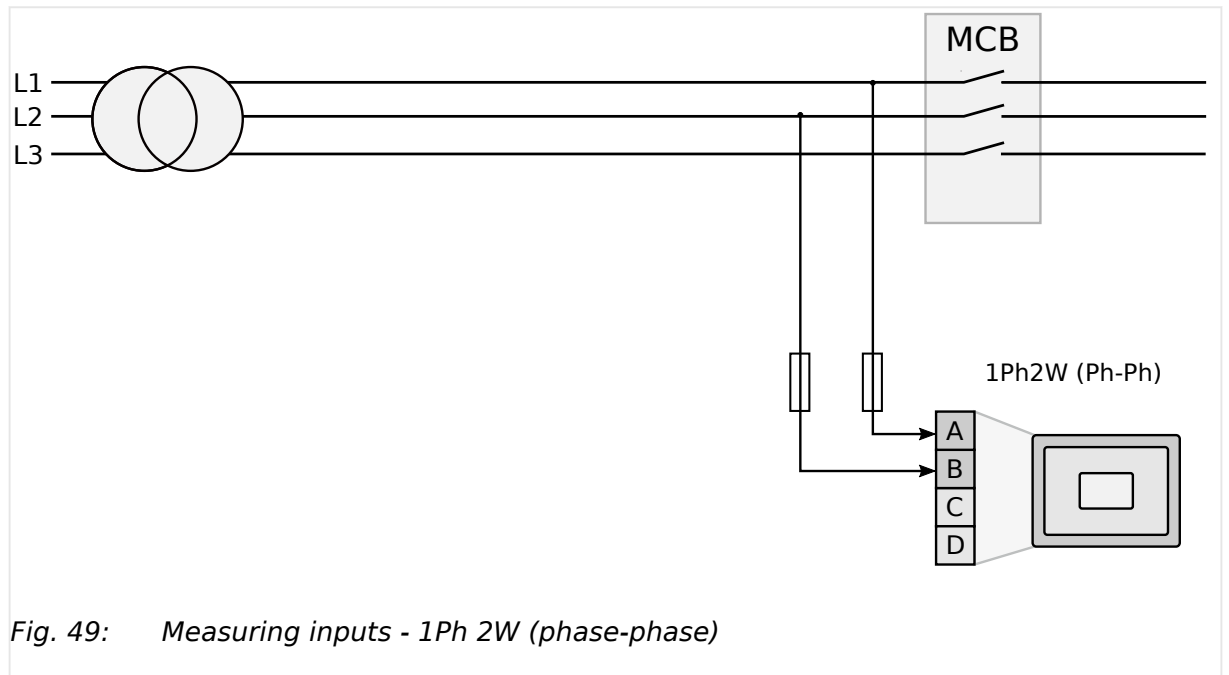

Fig. 49: Measuring inputs - 1Ph 2W (phase-phase)

Terminal assignment

Measuring input / Phase	Terminal	
Mains voltage - L1	A	22
Mains voltage - L2	B	24
Mains voltage - L3	-/-	-/-
-/-	-/-	26, 28

Table 16: Mains terminal assignment 1Ph 2W phase-phase

3.3.5.3 Busbar Voltage

General notes



The busbar voltage measuring of the easYgen-3400XT/3500XT-P2 provides both a general 1-phase measurement and a 3-phase measurement. Please have in mind that the **3-phase measurement needs other terminals located on another plug!** Furthermore the arrangement of L1, L2, L3 and N is re-arranged. Please read carefully the wiring diagram.



The voltage measuring inputs for 120 V, 480 V, and 690 V are using the same terminals 37 to 40 and 117 to 120. The current voltage range must be selected by the corresponding settings via HMI and/or ToolKit.

Parameter 1812 ("Busb1 PT secondary rated volt.") must be configured to the correct value to ensure proper measurement.



The busbar parameters in the device are often named with the affix "1". This preparation is done to avoid confusion e.g., if a model with a second busbar measurement is introduced.

Schematic and terminals

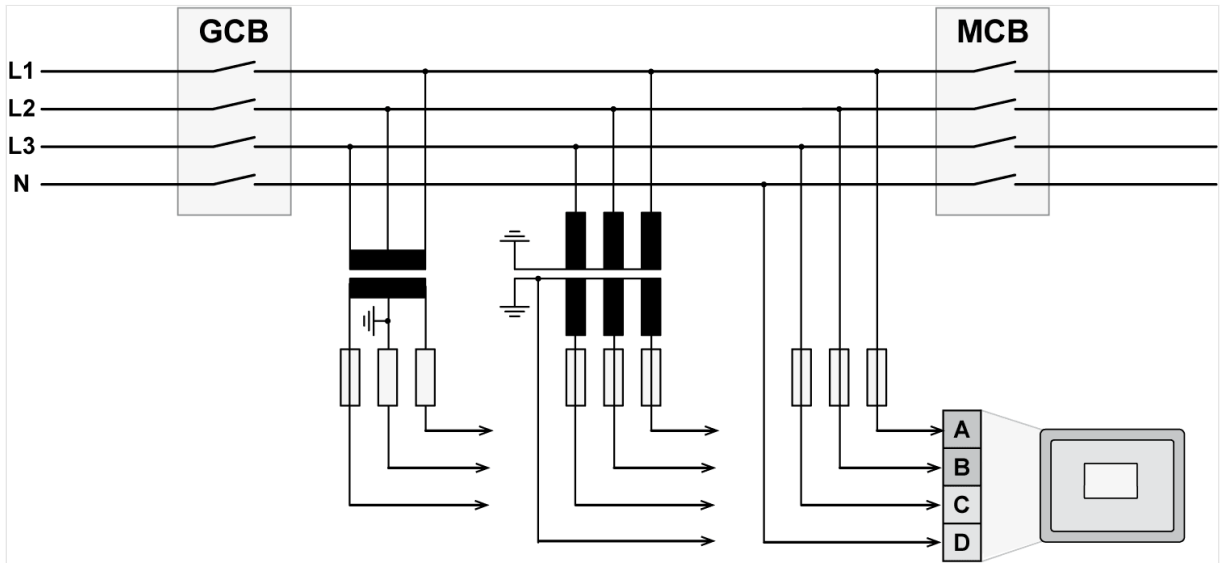

Fig. 50: Voltage measuring - busbar - wiring overview/examples

Measuring input / Phase	Terminal	
Busbar voltage - L1	A	38
Busbar voltage - L2	B	40
Busbar voltage - L3	C	118
Busbar voltage - N	D	120

Table 17: Voltage measuring - busbar - terminal assignment

3.3.5.3.1 Parameter Setting '3Ph 4W' (3-phase, 4-wire)

Busbar windings

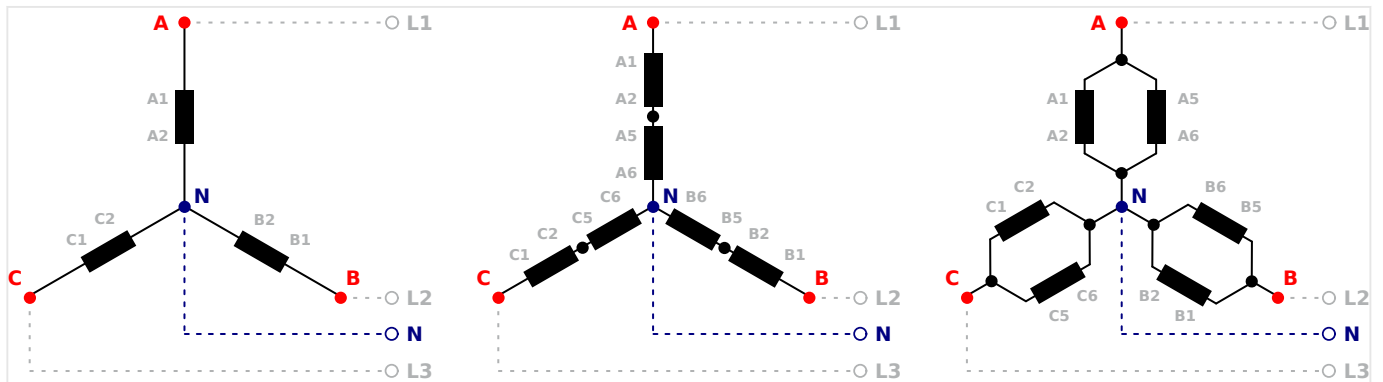

Fig. 51: Busbar windings - 3Ph 4W

Measuring inputs

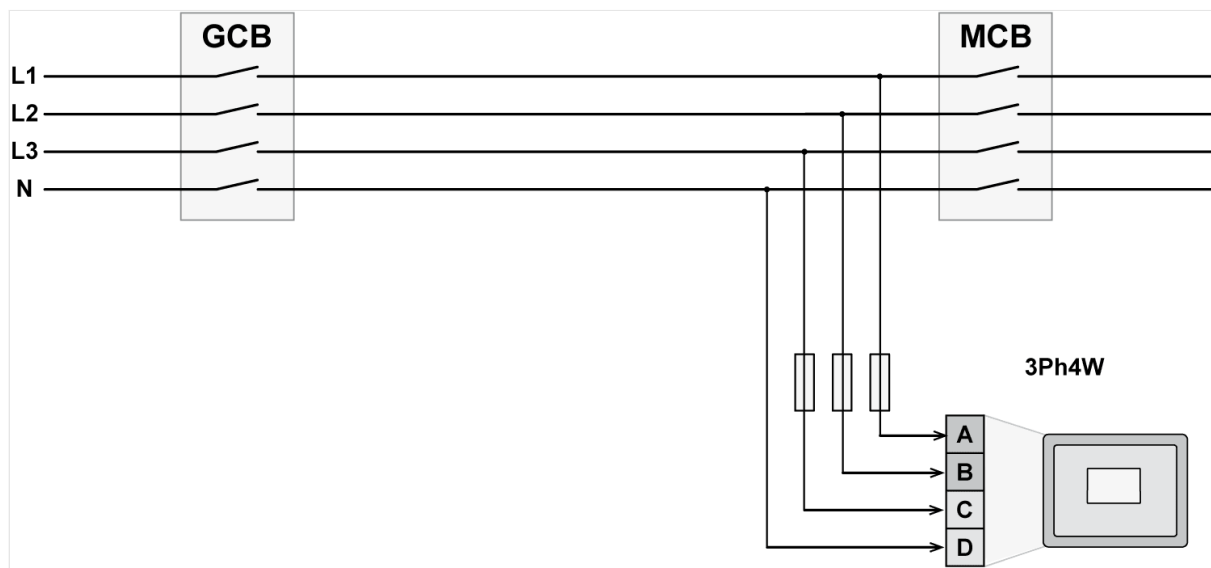

Fig. 52: Voltage measuring - busbar - wiring

Terminal assignment

Measuring input / Phase	Terminal	
Busbar voltage - L1	A	38
Busbar voltage - L2	B	40
Busbar voltage - L3	C	118
Busbar voltage - N	D	120

Table 18: Busbar terminal assignment 3Ph 4W

3.3.5.3.2 Parameter Setting '3Ph 3W' (3-phase, 3-wire)

Busbar windings

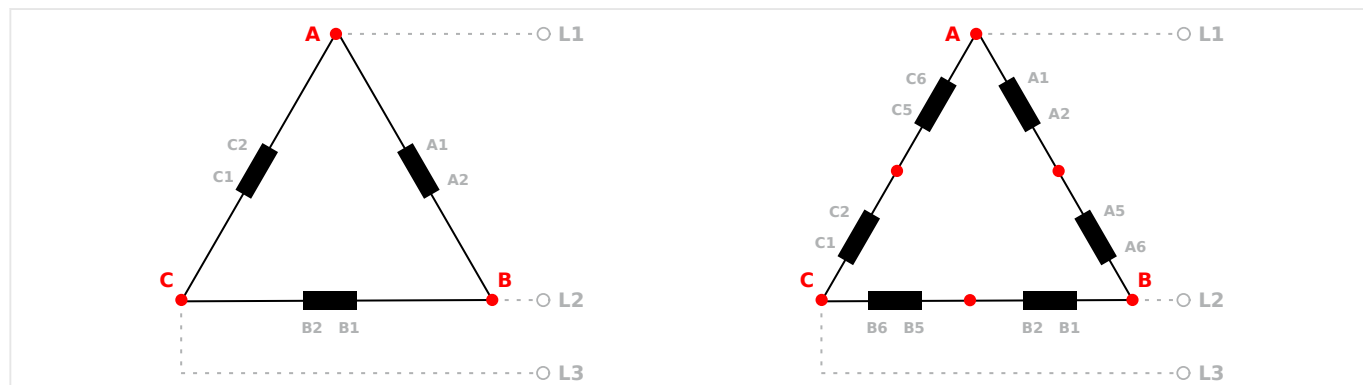

Fig. 53: Busbar windings - 3Ph 3W

Measuring inputs

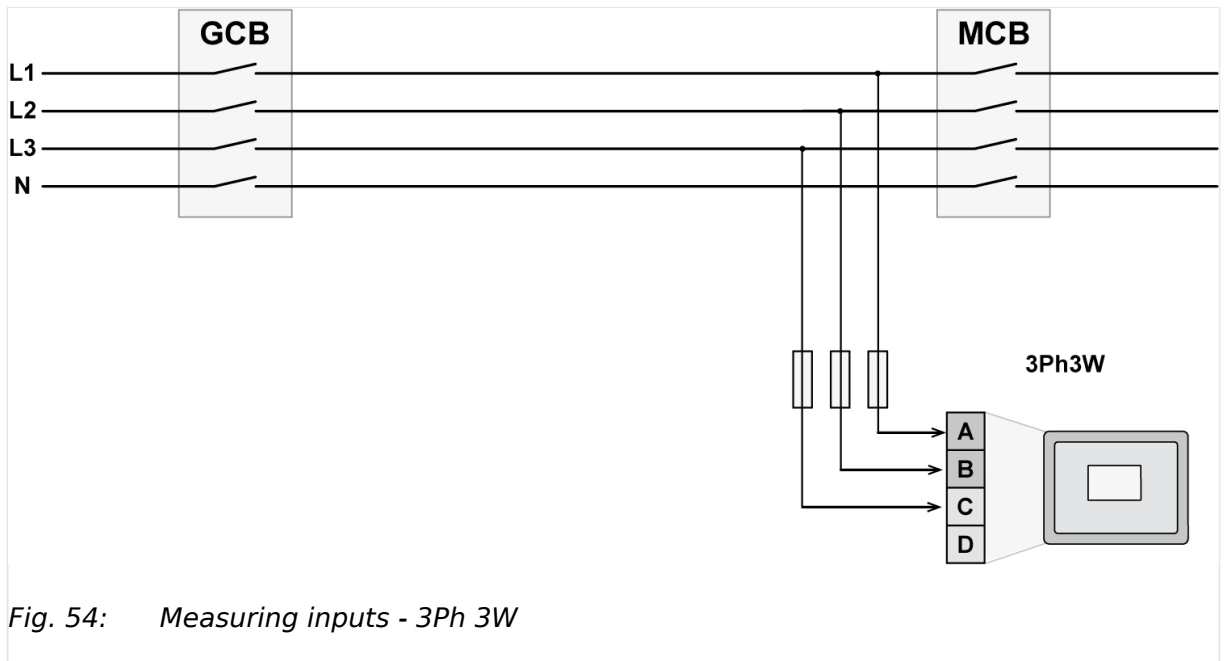

Fig. 54: Measuring inputs - 3Ph 3W

Terminal assignment

Measuring input / Phase	Terminal	
Busbar voltage - L1	A	38
Busbar voltage - L2	B	40
Busbar voltage - L3	C	118
-/-	D	120

Table 19: Busbar terminal assignment 3Ph 3W

3.3.5.3.3 Parameter Setting '1Ph 3W' (1-phase, 3-wire)

Busbar windings

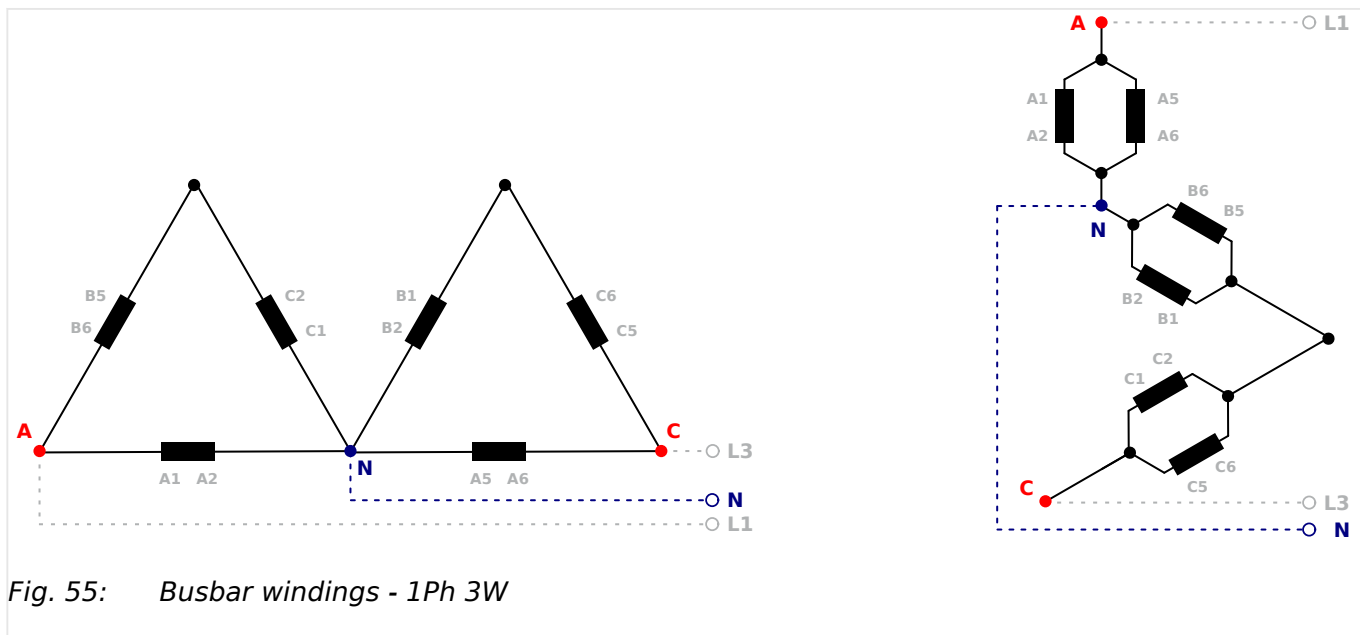

Fig. 55: Busbar windings - 1Ph 3W

Measuring inputs

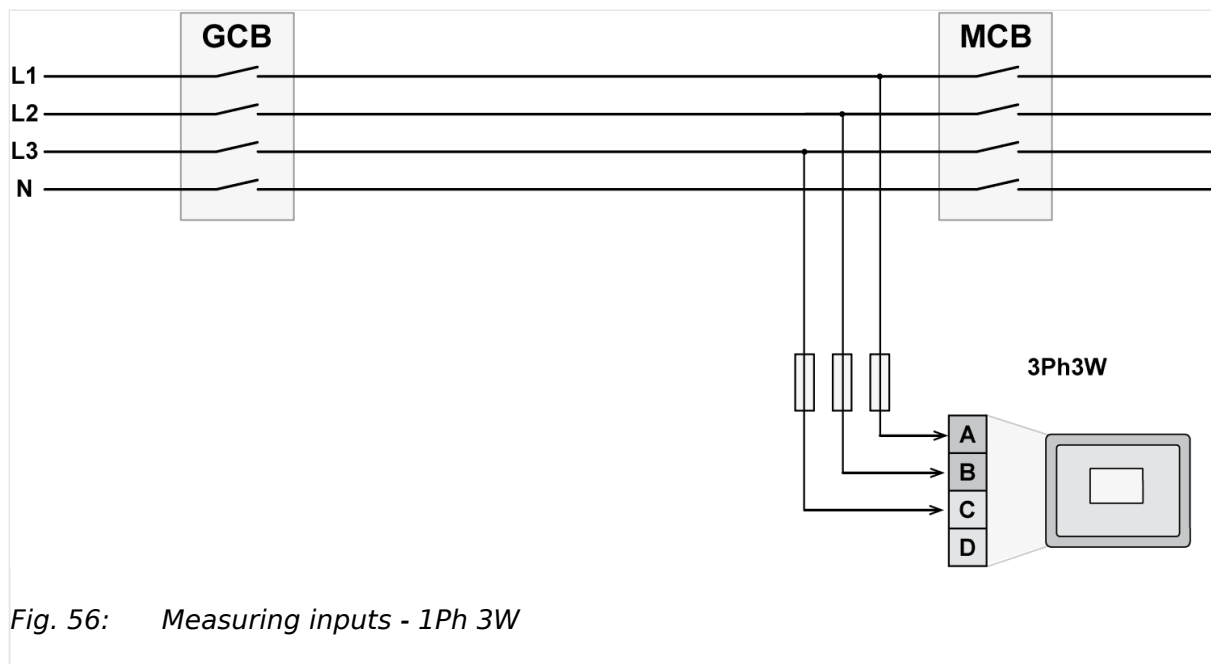

Fig. 56: Measuring inputs - 1Ph 3W

Terminal assignment

Measuring input / Phase	Terminal	
Busbar voltage - L1	A	38
Busbar voltage - N	B	40
	D	120

3 Installation

3.3.5.3.4 Parameter Setting '1Ph 2W' (1-phase, 2-wire)

Measuring input / Phase	Terminal	
Busbar voltage - L3	C	118

Table 20: Busbar terminal assignment 1Ph 3W

3.3.5.3.4 Parameter Setting '1Ph 2W' (1-phase, 2-wire)



The 1-phase, 2-wire measurement may be performed **phase-neutral** or **phase-phase**.

- Please note to configure and wire the easYgen consistently.

3.3.5.3.4.1 '1Ph 2W' Phase-Neutral Measuring

Busbar windings

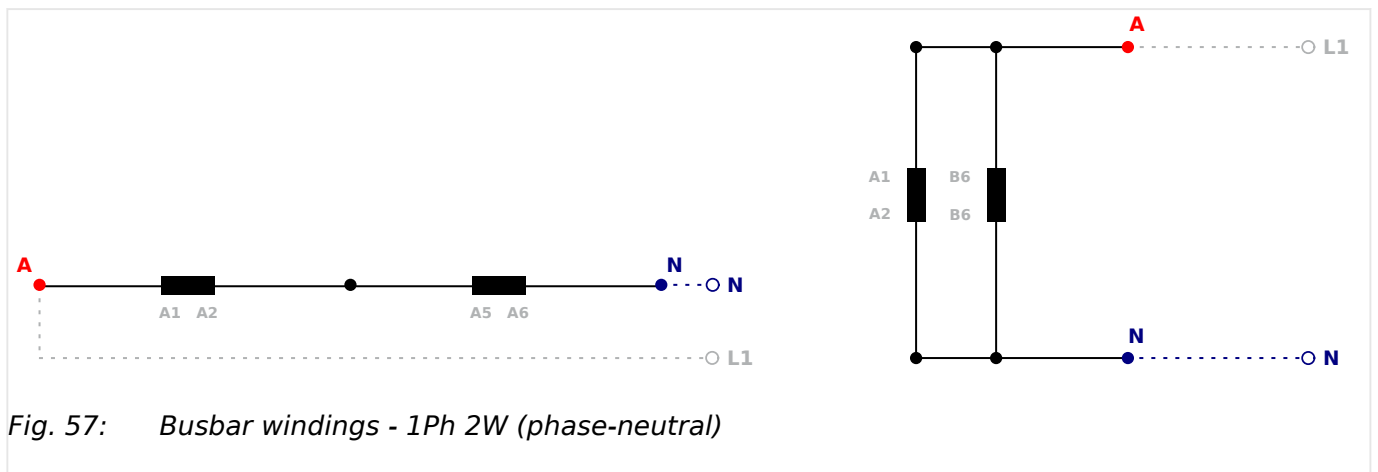

Fig. 57: Busbar windings - 1Ph 2W (phase-neutral)

Measuring inputs

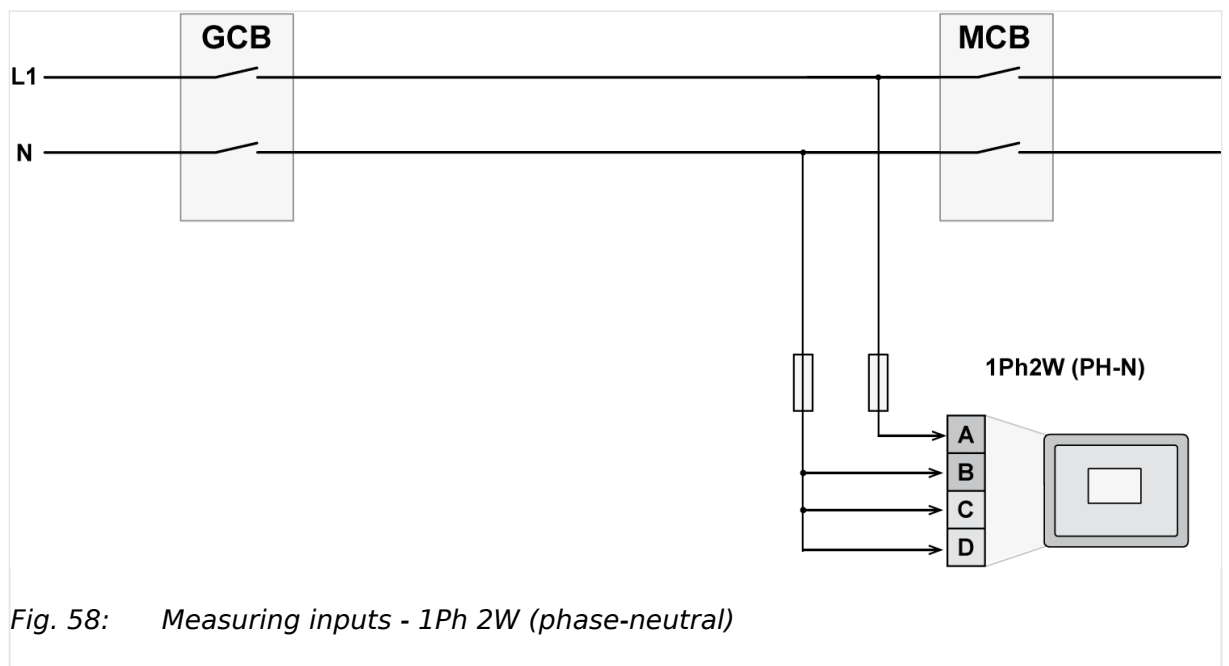

Fig. 58: Measuring inputs - 1Ph 2W (phase-neutral)

Terminal assignment

Measuring input / Phase	Terminal	
Busbar voltage - L1	A	38
Busbar voltage - N	B	40
	C	118
	D	120

Table 21: Busbar terminal assignment 1Ph 2W phase-neutral



Do not forget to **connect terminals B ,C, and D!** This is different to all easYgen-3000XT-P1 and the former easYgen-3000 series.

3.3.5.3.4.2 '1Ph 2W' Phase-Phase Measuring

Busbar windings

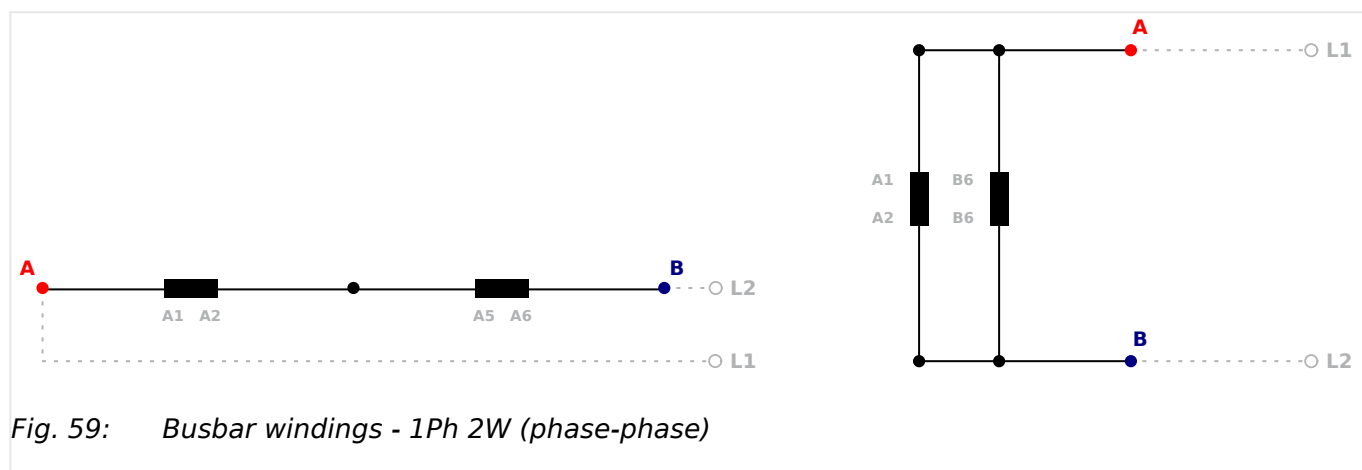

Fig. 59: Busbar windings - 1Ph 2W (phase-phase)

Measuring inputs

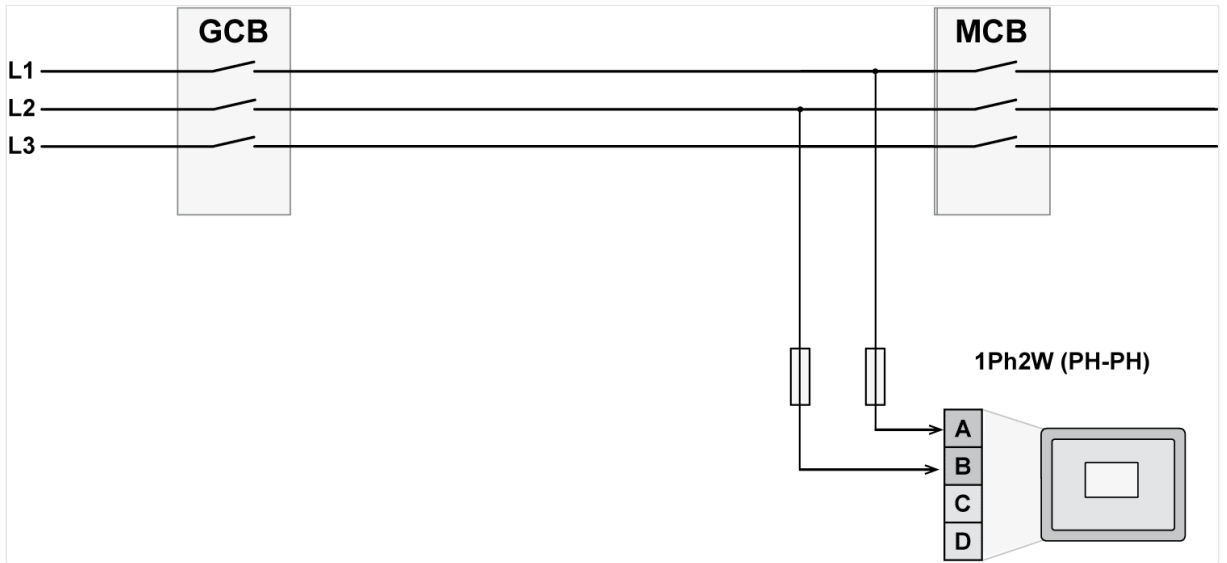

Fig. 60: Measuring inputs - 1Ph 2W (phase-phase)

Terminal assignment

Measuring input / Phase	Terminal	
Busbar voltage - L1	A	38
Busbar voltage - L2	B	40
-/-	C	118
	D	120

Table 22: Busbar terminal assignment 1Ph 2W phase-phase

3.3.6 Current Measuring

3.3.6.1 Generator Current

General notes

WARNING!



Dangerous voltages due to missing load

- Before disconnecting the device, ensure that the current transformer (CT) is short-circuited.



The current measuring inputs for 1 A and 5 A are using the same terminals 3 to 8. The current range must be selected by the corresponding settings via HMI and/or ToolKit.



Generally, one line of the current transformers secondary must be grounded close to the CT.

CAUTION!



External current transformers shall provide insulation adequate to system voltage to which unit is connected.

Schematic and terminals

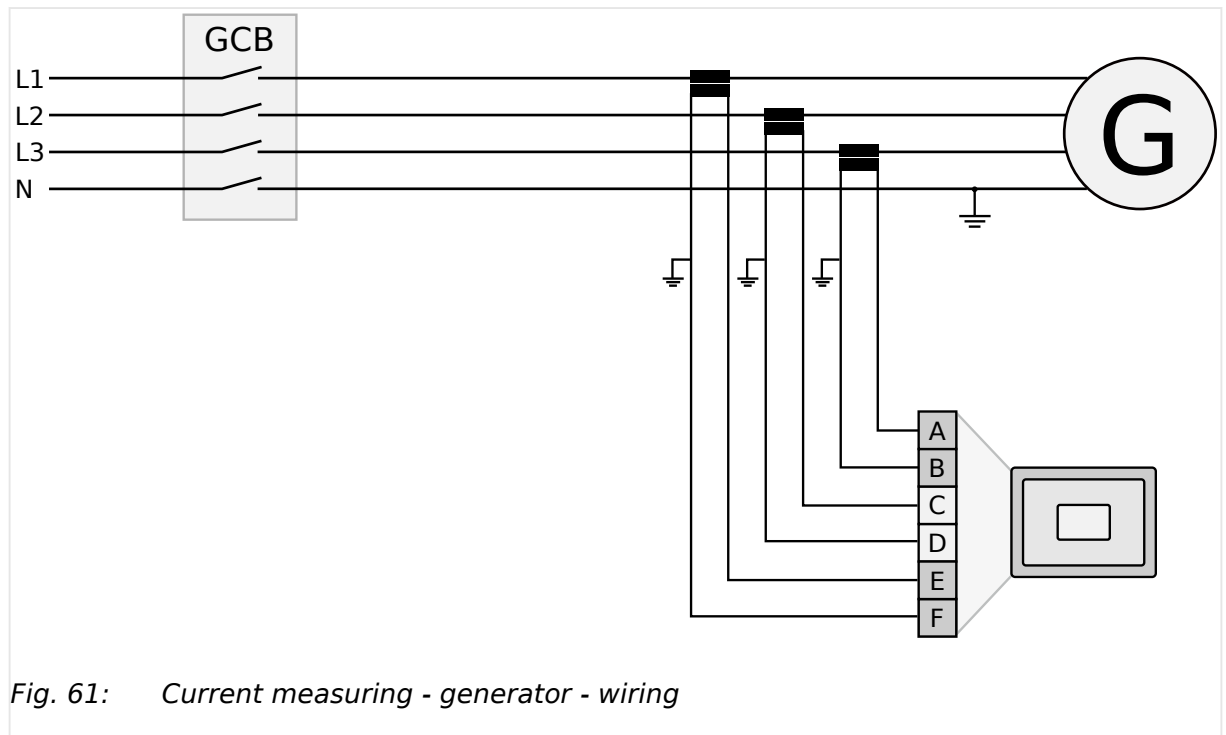

Fig. 61: Current measuring - generator - wiring

Terminal		Description
A	8	Generator current - L3 - transformer terminal s1 (k)
B	7	Generator current - L3 - transformer terminal s2 (l)
C	6	Generator current - L2 - transformer terminal s1 (k)
D	5	Generator current - L2 - transformer terminal s2 (l)
E	4	Generator current - L1 - transformer terminal s1 (k)
F	3	Generator current - L1 - transformer terminal s2 (l)

Table 23: Current measuring - generator - terminal assignment

3.3.6.1.1 Parameter Setting 'L1 L2 L3'

Schematic and terminals

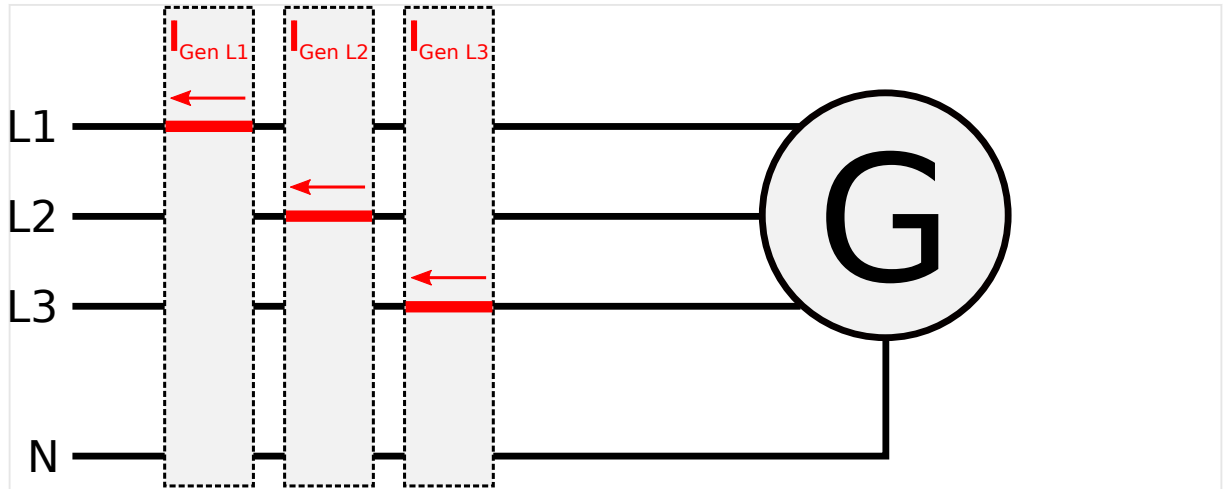

Fig. 62: Current measuring - generator, L1 L2 L3

	Wiring terminals					
	F	E	D	C	B	A
L1 L2 L3						
Terminal	3	4	5	6	7	8
Phase	s2 (l) L1	s1 (k) L1	s2 (l) L2	s1 (k) L2	s2 (l) L3	s1 (k) L3
Phase L1 and L3						
Terminal	3	4	5	6	7	8
Phase	s2 (l) L1	s1 (k) L1	—	—	s2 (l) L3	s1 (k) L3



"Phase L1 and L3" applies if the generator voltage measurement is configured to 1Ph 3W (➡ "3.3.5.1 Generator Voltage").

3.3.6.1.2 Parameter Setting 'Phase L1' 'Phase L2' 'Phase L3'

Schematic and terminals

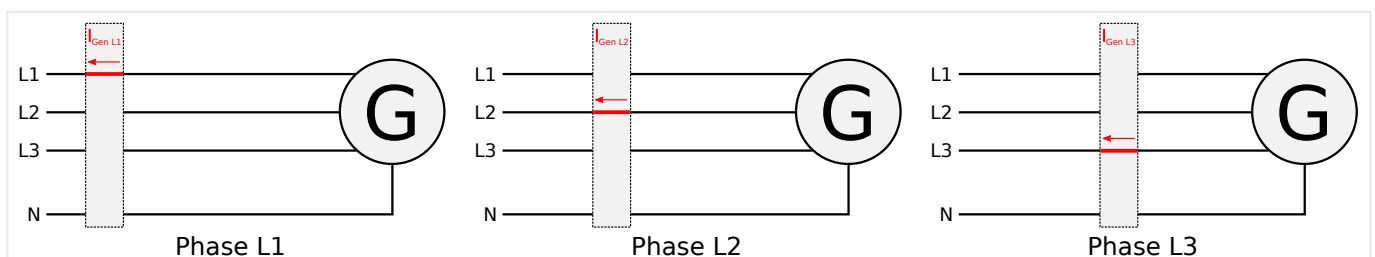

Fig. 63: Current measuring - generator, 'Phase L1' 'Phase L2' 'Phase L3'

	Wiring terminals					
	F	E	D	C	B	A
Phase L1						
Terminal	3	4	5	6	7	8
Phase	s2 (l) L1	s1 (k) L1	—	—	—	—
Phase L2						
Terminal	3	4	5	6	7	8
Phase	—	—	s2 (l) L2	s1 (k) L2	—	—
Phase L3						
Terminal	3	4	5	6	7	8
Phase	—	—	—	—	s2 (l) L3	s1 (k) L3

3.3.6.2 Mains Current

General notes

WARNING!



Dangerous voltages due to missing load

- Before disconnecting the device, ensure that the current transformer (CT) is short-circuited.



The current measuring inputs for 1 A and 5 A are using the same terminals 1 to 2. The current range must be selected by the corresponding settings via HMI and/or ToolKit.



Generally, one line of the current transformers secondary must be grounded close to the CT.

Schematic and terminals

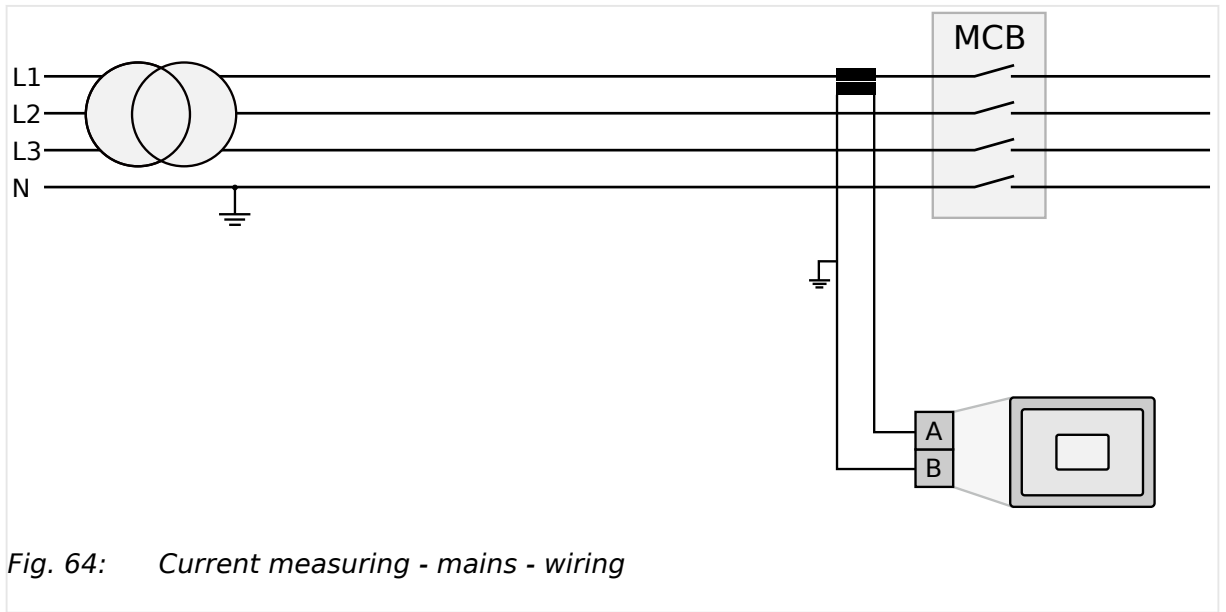

Fig. 64: Current measuring - mains - wiring

Terminal		Description
A	2	Mains current - transformer terminal s1 (k)
B	1	Mains current - transformer terminal s2 (l)

Table 24: Current measuring - mains - terminal assignment

3.3.6.2.1 Parameter Setting 'Phase L1' 'Phase L2' 'Phase L3'

Schematic and terminals

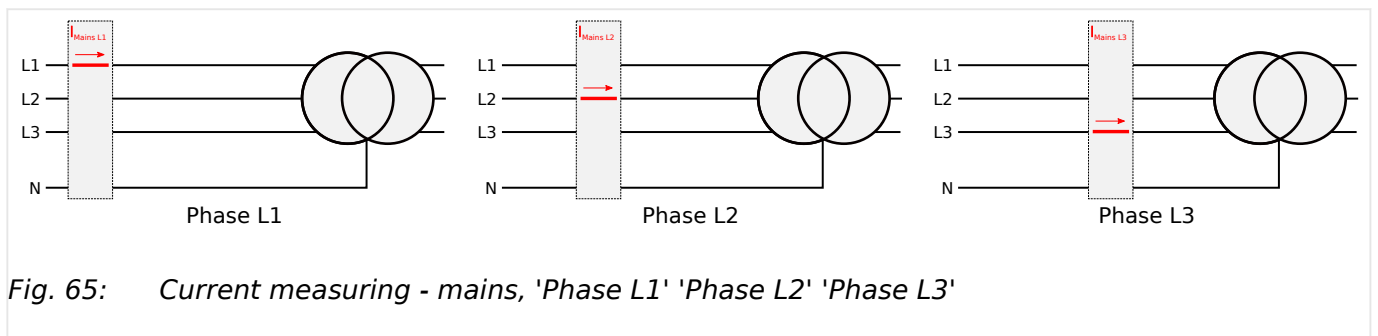

Fig. 65: Current measuring - mains, 'Phase L1' 'Phase L2' 'Phase L3'

	Wiring terminals	
	B	A
Phase L1		
Terminal	1	2
Phase	s2 (l) - L1	s1 (k) - L1
Phase L2		
Terminal	1	2
Phase	s2 (l) - L2	s1 (k) - L2
Phase L3		

	Wiring terminals	
Terminal	1	2
Phase	s2 (l) - L3	s1 (k) - L3

3.3.6.3 Ground Current

General notes

WARNING!



Dangerous voltages due to missing load

- Before disconnecting the device, ensure that the current transformer (CT) is short-circuited.



The current measuring inputs for 1 A and 5 A are using the same terminals 1 to 2. The current range must be selected by the corresponding settings via HMI and/or ToolKit.



The mains current input can be configured to measure the mains current or ground current. The parameter 'Mains current input' determines, if this input will measure the mains current (default) or the ground current.



Generally, one line of the current transformers secondary must be grounded close to the CT.

Schematic and terminals

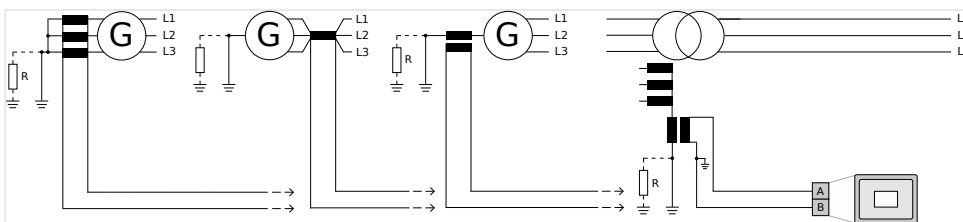

Fig. 66: Current measuring - ground current - wiring

Terminal	Description
A	2 Ground current - transformer terminal s1 (k)

Terminal		Description
B	1	Ground current - transformer terminal s2 (l)

Table 25: Current measuring - ground current - terminal assignment

3.3.7 Power Measuring

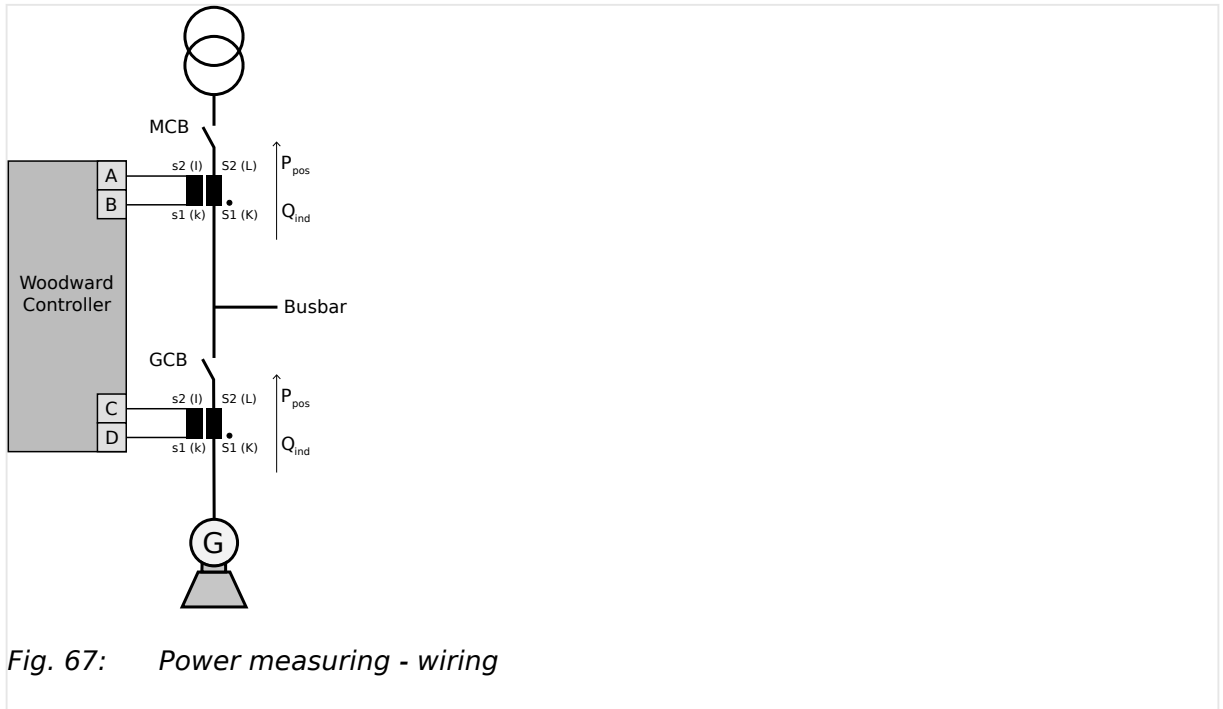

Fig. 67: Power measuring - wiring

If the unit's current transformers are wired according to the diagram (↳ Fig. 67), the following values are displayed.

Terminal		Description
A	1	Mains or ground current
B	2	
C	3 5 7	Generator current
D	4 6 8	

Parameter	Description	Sign displayed
Generator real power	Genset generating kW	+ Positive
Generator real power	Genset in reverse power	- Negative
Generator power factor (cos φ)	Inductive / lagging	+ Positive
Generator power factor (cos φ)	Capacitive / leading	- Negative
Mains real power	Plant exporting kW +	+ Positive
Mains real power	Plant importing kW -	- Negative

Parameter	Description	Sign displayed
Mains power factor (cos φ)	Inductive / lagging	+ Positive
Mains power factor (cos φ)	Capacitive / leading	- Negative



Measuring 3PH 3W

The values of single active power, reactive power, and power factor in L1, L2 and L3 are not displayed. This values can not be determined through this connection type.

3.3.8 Power Factor Definition

Definition

Power Factor is defined as a ratio of the real power to apparent power. In a purely resistive circuit, the voltage and current waveforms are instep resulting in a ratio or power factor of 1.00 (often referred to as unity).

In an inductive circuit the current lags behind the voltage waveform resulting in usable power (real power) and unusable power (reactive power). This results in a positive ratio or lagging power factor (i.e. 0.85 lagging).

In a capacitive circuit the current waveform leads the voltage waveform resulting in usable power (real power) and unusable power (reactive power). This results in a negative ratio or a leading power factor (i.e. 0.85 leading).

Properties

	Inductive	Capacitive
Load type	Electrical load whose current waveform lags the voltage waveform thus having a lagging power factor. Some inductive loads such as electric motors have a large startup current requirement resulting in lagging power factors.	Electrical load whose current waveform leads the voltage waveform thus having a leading power factor. Some capacitive loads such as capacitor banks or buried cable result in leading power factors.
Different power factor display on the unit	i0.91 (inductive) lg.91 (lagging)	c0.93 (capacitive) ld.93 (leading)
Reactive power display on the unit	70 kvar (positive)	-60 kvar (negative)
Output of the interface	+ (positive)	- (negative)
Current relation to voltage	Lagging	Leading
Generator state	Overexcited	Underexcited
Control signal	If the control unit is equipped with a power factor controller while in parallel with the utility:	
	A voltage lower "-" signal is output as long as the measured value is "more inductive" than the reference setpoint	A voltage raise "+" signal is output as long as the measured value is "more capacitive" than the reference setpoint

	Inductive	Capacitive
	Example: measured = i0.91; setpoint = i0.95	Example: measured = c0.91; setpoint = c0.95

Phasor diagram

 The phasor diagram is used from the generator's view.

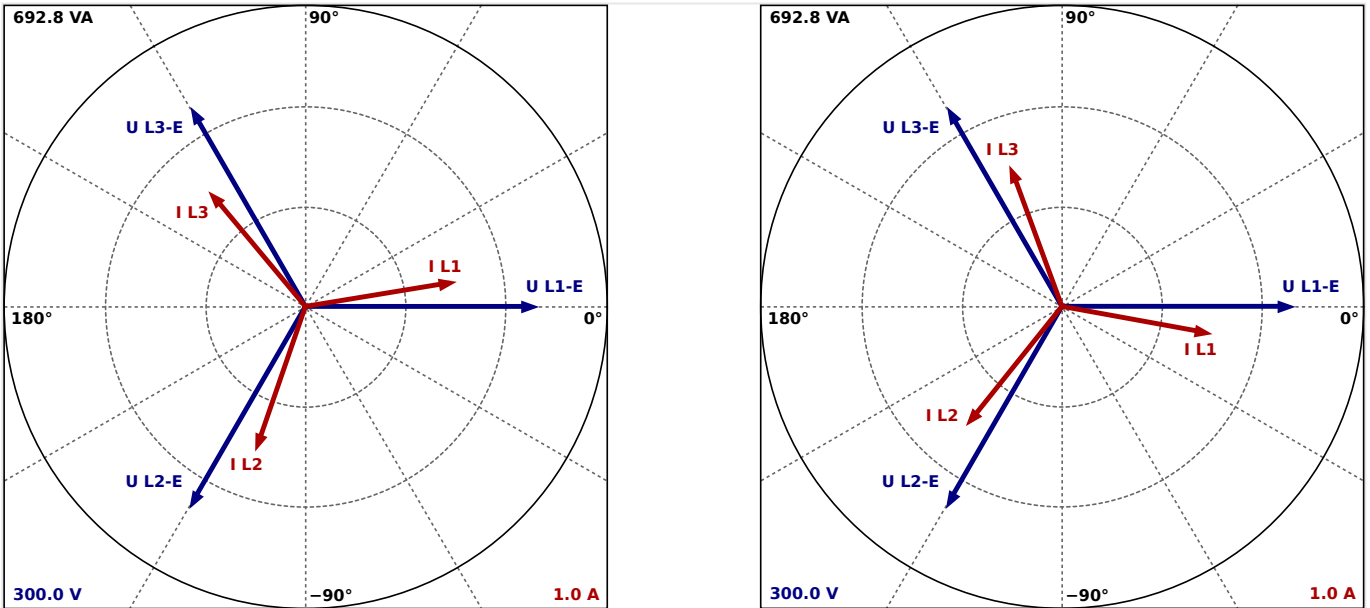



Fig. 68: Phasor diagram: capacitive load (left) and inductive load (right)

3.3.9 Magnetic Pickup Unit (MPU)

General notes

 The shield of the MPU (Magnetic Pickup Unit) connection cable must be connected to a single point ground terminal near the easYgen.
 The shield must not be connected at the MPU side of the cable.

 The number of teeth on the flywheel reference gear and the flywheel speed must be configured so that the magnetic pickup input frequency does not exceed 14 kHz.

Overview

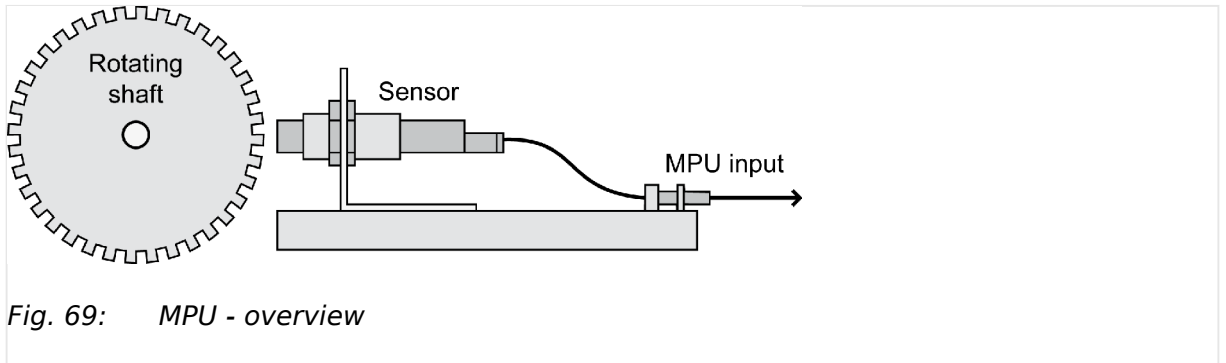

Fig. 69: MPU - overview

Schematic and terminals

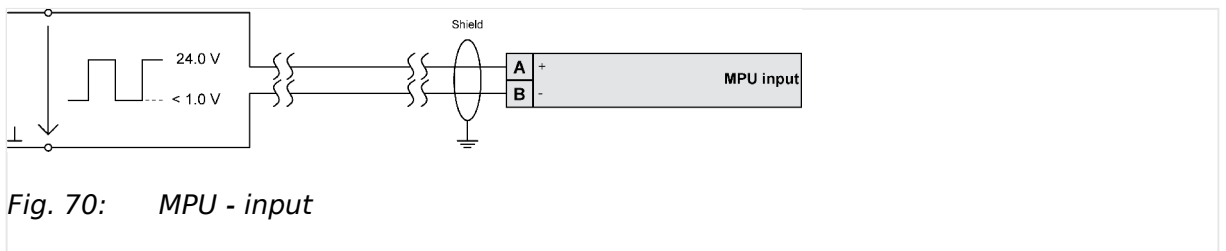

Fig. 70: MPU - input

Terminal		Description
A	79	MPU input - inductive/switching
B	80	MPU input - GND

Characteristic

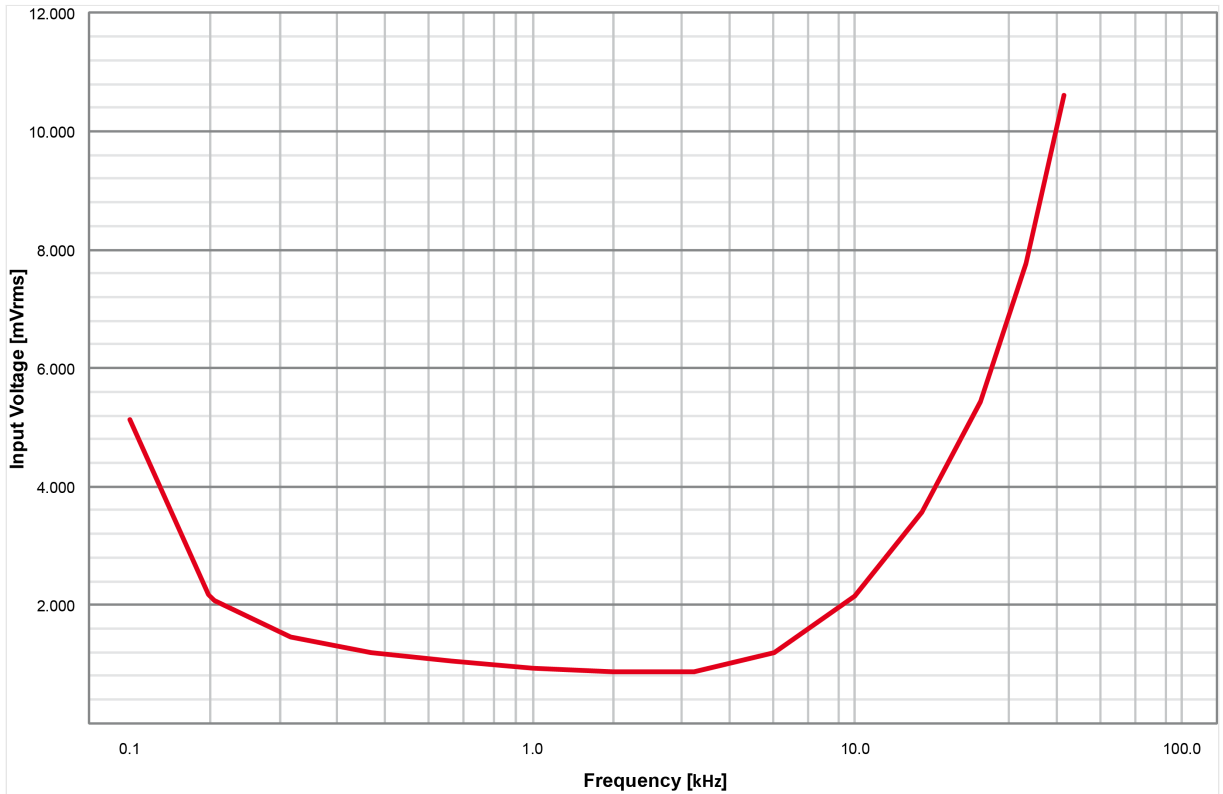

Fig. 71: MPU - characteristic



Fig. 71 shows the minimal necessary input voltage depending on frequency. It is recommended to ensure input voltage greater than minimal necessary with a margin of 2 to 3 V (especially at high ambient temperature above +50 °C).

3.3.10 Discrete Inputs

General notes

WARNING!



Hazards due to improper implementation of emergency stop

Discrete input [DI 01] "Emergency Stop" is only a signaling input. This input may only be used to signal that an external emergency stop button has been actuated.

According to EN 60204, this input is not approved to be used as the emergency stop function.

- The emergency stop function must be implemented external to the control and cannot rely on the control to function properly.



The discrete inputs are electrically isolated which permits the polarity of the connections to be either positive or negative.

- All discrete inputs must use the same polarity, either positive or negative signals, due to the common ground.

Schematic and terminal assignment

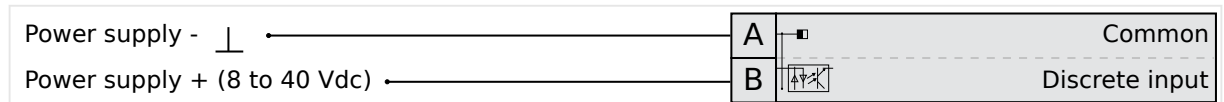

Fig. 72: Discrete input - positive polarity signal

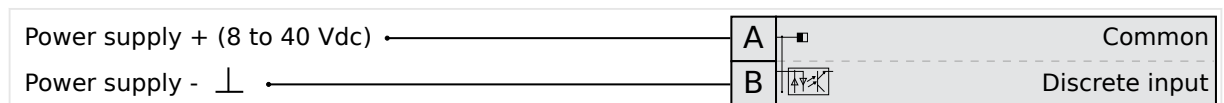



Fig. 73: Discrete input - negative polarity signal

Terminal		Description	
A	B		
66	67	Discrete Input [DI 01]	Preconfigured to "Emergency stop" ¹
GND	68	Discrete Input [DI 02]	Preconfigured to "Start in AUTO" ¹
Common ground	69	Discrete Input [DI 03]	Preconfigured to "Low oil pressure" ¹
	70	Discrete Input [DI 04]	Preconfigured to "Coolant temperature" ¹
	71	Discrete Input [DI 05]	Preconfigured to "Alarm acknowledge" ¹
	72	Discrete Input [DI 06]	Preconfigured to "Enable MCB" ¹
	73	Discrete Input [DI 07]	Fixed to "Reply MCB" if A01 - A06
	74	Discrete Input [DI 08]	Fixed to "Reply GCB"
	75	Discrete Input [DI 09]	Fixed to "Reply GGB" if A05 , A06 or A09
	76	Discrete Input [DI 10]	Fixed to "Voltage monitoring load busbar" if A05 , A06 or A09 and 3441 is set to "On"
	77	Discrete Input [DI 11]	LogicsManager ¹
	78	Discrete Input [DI 12]	LogicsManager ¹

Table 26: DI 01-12

Terminal		Description	
A	B		
152	141	Discrete Input [DI 13]	LogicsManager ¹
GND	142	Discrete Input [DI 14]	LogicsManager ¹
Common ground	143	Discrete Input [DI 15]	LogicsManager ¹
	144	Discrete Input [DI 16]	LogicsManager ¹
	145	Discrete Input [DI 17]	LogicsManager ¹
	146	Discrete Input [DI 18]	LogicsManager ¹
	147	Discrete Input [DI 19]	LogicsManager ¹
	148	Discrete Input [DI 20]	LogicsManager ¹
	149	Discrete Input [DI 21]	LogicsManager ¹
	150	Discrete Input [DI 22]	LogicsManager ¹
	151	Discrete Input [DI 23]	LogicsManager ¹

Table 27: DI 13-23



¹ configurable via LogicsManager

Operation logic

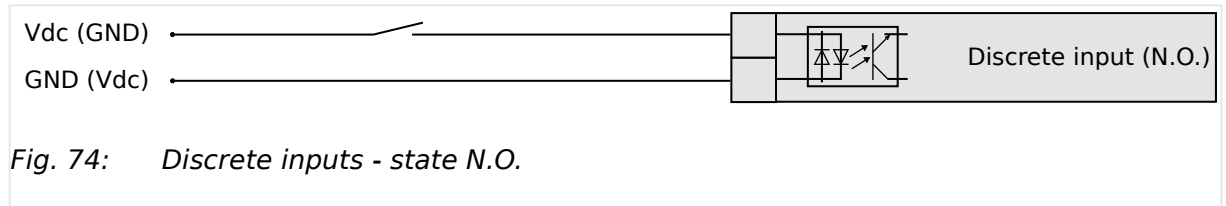
Discrete inputs may be configured to normally open (N.O.) or normally closed (N.C.) states.

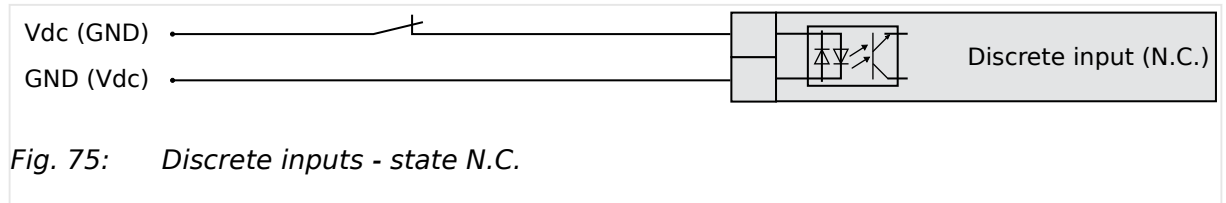

In the state N.O., no potential is present during normal operation; if an alarm is issued or control operation is performed, the input is energized.



In the state N.C., a potential is continuously present during normal operation; if an alarm is issued or control operation is performed, the input is de-energized.

The N.O. or N.C. contacts may be connected to the signal terminal as well as to the ground terminal of the discrete input ("Schematic and terminal assignment").#

3.3.11 Relay Outputs (LogicsManager)

General notes

CAUTION!



The relay output "Ready for operation" must be wired in series with an emergency stop function. This means that it must be ensured that the generator circuit breaker is opened and the engine is stopped if this relay output is de-energize.

- We recommend to signal this fault independently from the unit if the availability of the plant is important.



For information on interference suppressing circuits when connecting 24 V relays, please refer to [3.3.11.1 Connecting 24 V Relays](#).

Schematic and terminals

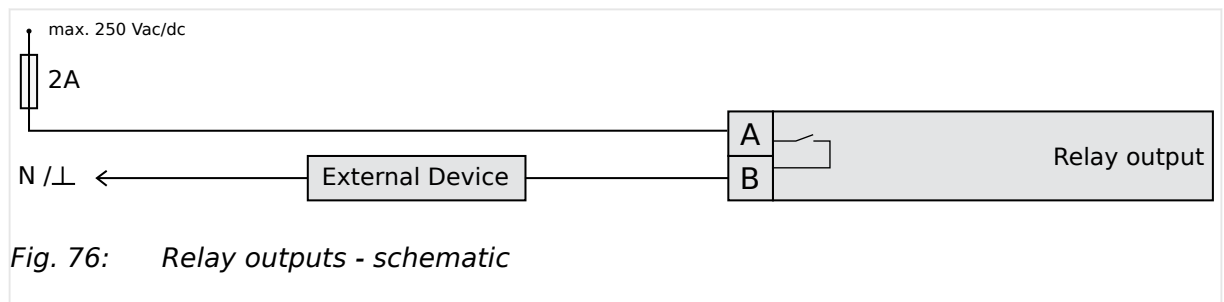

Fig. 76: Relay outputs - schematic

Terminal		Description		
N.O.	Common			
A	B	Form A		
<i>PCB 1 identical for all easYgen-3000XT:</i>				
42	41	Relay output [R 01]	All	Fixed to "Ready for operation" ¹
43	46	Relay output [R 02]	All	Preconfigured to "Centralized alarm" ¹
44		Relay output [R 03]	All	Preconfigured to "Starter" ¹
45		Relay output [R 04]	All	Preconfigured to "Fuel solenoid / gas valve" ¹
48	47	Relay output [R 05]	All	Preconfigured to "Preglow" ¹
50	49	Relay output [R 06]	A01 A02	LogicsManager ¹
			A03 to A11	Fixed to "Command: close GCB" ¹
52	51	Relay output [R 07]	A01	Preconfigured to "Mains decoupling" ¹
			A02 to A11	Fixed to "Command: open GCB" if parameter 3403 "GCB open relay" is not configured to "Not used" ¹
54	53	Relay output [R 08]	A01 A02 A03 A05 A07 A08	LogicsManager ¹

3 Installation

3.3.11 Relay Outputs (LogicsManager)

Terminal		Description		
N.O.	Common			
A	B	Form A		
			A09 A10 A11	
			A04 A06	Fixed to "Command: close MCB" ¹
56	55	Relay output [R 09]	A01 A02 A03 A05 A07 A08 A09 A10 A11	Preconfigured to "Mains decoupling" ¹
			A04 A06	Fixed to "Command: open MCB" if parameter 3398 "MCB open relay" is not configured to "Not used" ¹
57	60	Relay output [R 10]	A01 A02 A03 A04 A07 A08 A10 A11	Preconfigured to "Auxiliary services" ¹
			A05 A06 A09	Fixed to "Command: close GGB" ¹
58		Relay output [R 11]	A01 A02 A03 A04 A07 A08 A10 A11	Preconfigured to "Alarm class A and B" ¹
			A05 A06 A09	Fixed to "Command: open GGB" if parameter 3471 "GGB open relay" is not configured to "Not used" ¹
59		Relay output [R 12]	All	Preconfigured to "Alarm class C, D, E or F" ¹
<i>PCB 2 only:</i>				
121	122	Relay output [R 12]	All	Configurable via LogicsManager
123	124	Relay output [R 12]	All	Configurable via LogicsManager
125	126	Relay output [R 12]	All	Configurable via LogicsManager
127	128	Relay output [R 12]	All	Configurable via LogicsManager
129	130	Relay output [R 12]	All	Configurable via LogicsManager
131	132	Relay output [R 12]	All	Configurable via LogicsManager
133	134	Relay output [R 12]	All	Configurable via LogicsManager
135	136	Relay output [R 12]	All	Configurable via LogicsManager
137	138	Relay output [R 12]	All	Configurable via LogicsManager
139	140	Relay output [R 12]	All	Configurable via LogicsManager



¹ configurable via LogicsManager

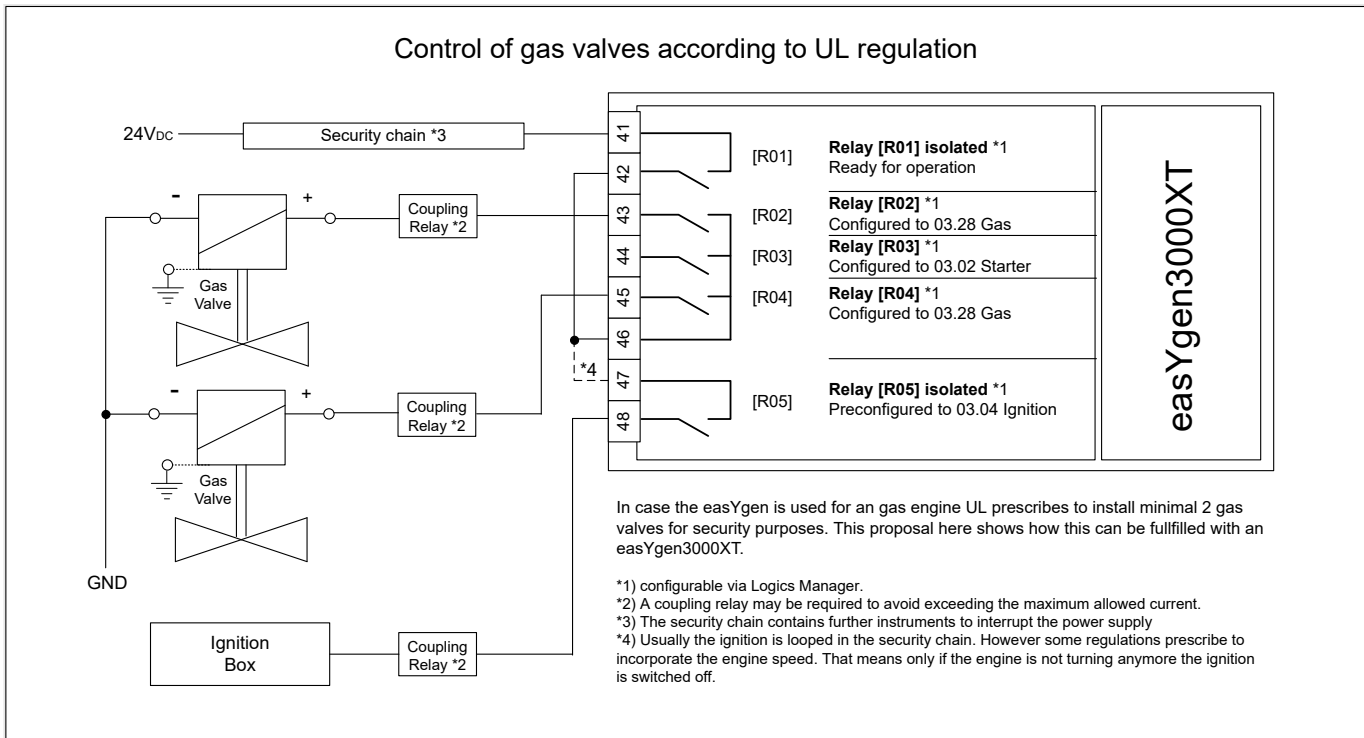

Fig. 77: Control of gas valves according to UL regulation

3.3.11.1 Connecting 24 V Relays

NOTICE!

!

Damage to adjacent electronic components due to induced voltages

- Implement protection circuits as detailed below.

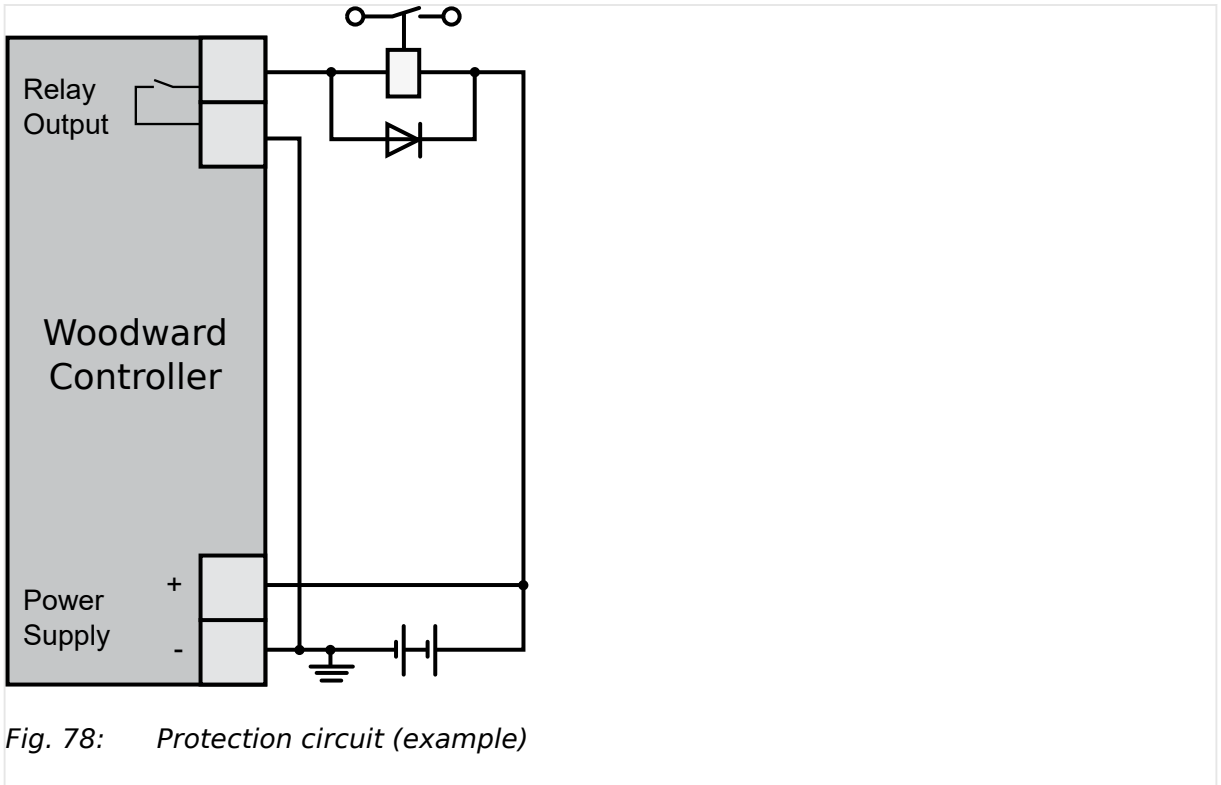

Fig. 78: Protection circuit (example)

Interferences in the interaction of all components may affect the function of electronic devices. One interference factor is disabling inductive loads, like coils of electromagnetic switching devices.

When disabling such a device, high switch-off induced voltages may occur, which might destroy adjacent electronic devices or result interference voltage pulses, which lead to functional faults, by capacitive coupling mechanisms.

Since an interference-free switch-off is not possible without additional equipment, the relay coil is connected with an interference suppressing circuit.

If 24 V (coupling) relays are used in an application, it is required to connect a protection circuit to avoid interferences.



Fig. 78 shows the exemplary connection of a diode as an interference suppressing circuit.

Advantages and disadvantages of different interference suppressing circuits are as follows:

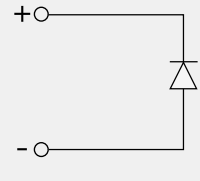
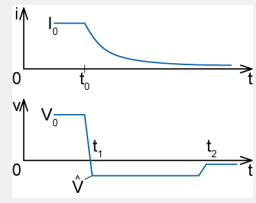
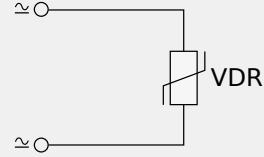
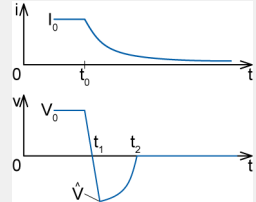
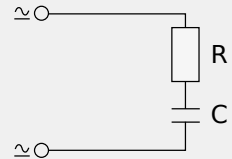
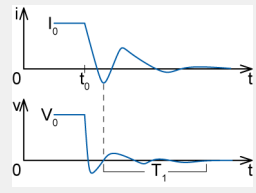
Connection diagram	Load current / voltage curve	Advantages	Disadvantages
		<ul style="list-style-type: none"> Uncritical dimensioning Lowest possible induced voltage Very simple and reliable 	High release delay
		<ul style="list-style-type: none"> Uncritical dimensioning High energy absorption Very simple setup Suitable for AC voltage Reverse polarity protected 	No attenuation below VVDR
		<ul style="list-style-type: none"> HF attenuation by energy storage Immediate shut-off limiting Attenuation below limiting voltage Very suitable for AC voltage Reverse polarity protected 	Exact dimensioning required

3.3.12 Analog Inputs

The easYgen offers Analog Inputs for different applications and measuring standards such as current, voltage or resistance:

- **AI01-AI03** 0 to 2000 Ohm | 0/4 to 20 mA | 0 to 1 V
- **AI04-AI06** 0 to 10 V | 0/4 to 20 mA
- **AI07-AI10** 0 to 250/2500 Ohm

3.3.12.1 Analog Inputs (0 to 2000 Ohm | 0/4 to 20 mA | 0 to 1 V)

It is recommended to use two-pole analog senders for best possible accuracy.



Connect the **resistive** analog input's return wires (GND) always to Engine Ground (terminal 15) and as close to the easYgen terminals as possible.

For two pole senders of **0/4 to 20 mA** or **0 to 1 V** sensors Engine Ground is no "must have".

The following curves may be used for the analog inputs:

- Table A
- Table B

3 Installation

3.3.12.1 Analog Inputs (0 to 2000 Ohm | 0/4 to 20 mA | 0 to 1 V)

- Linear
- Pt100
- Pt1000
- AB 94099
- VDO 120° C
- VDO 150° C
- VDO 10 bar
- VDO 5 bar

The 9 setpoints of the free configurable Tables A and B can be selected for Type definition (parameters 1000, 1050, and 1100).

A catalog of all available VDO sensors is available for download at the VDO homepage (=> <https://www.vdo.com>)

Wiring senders

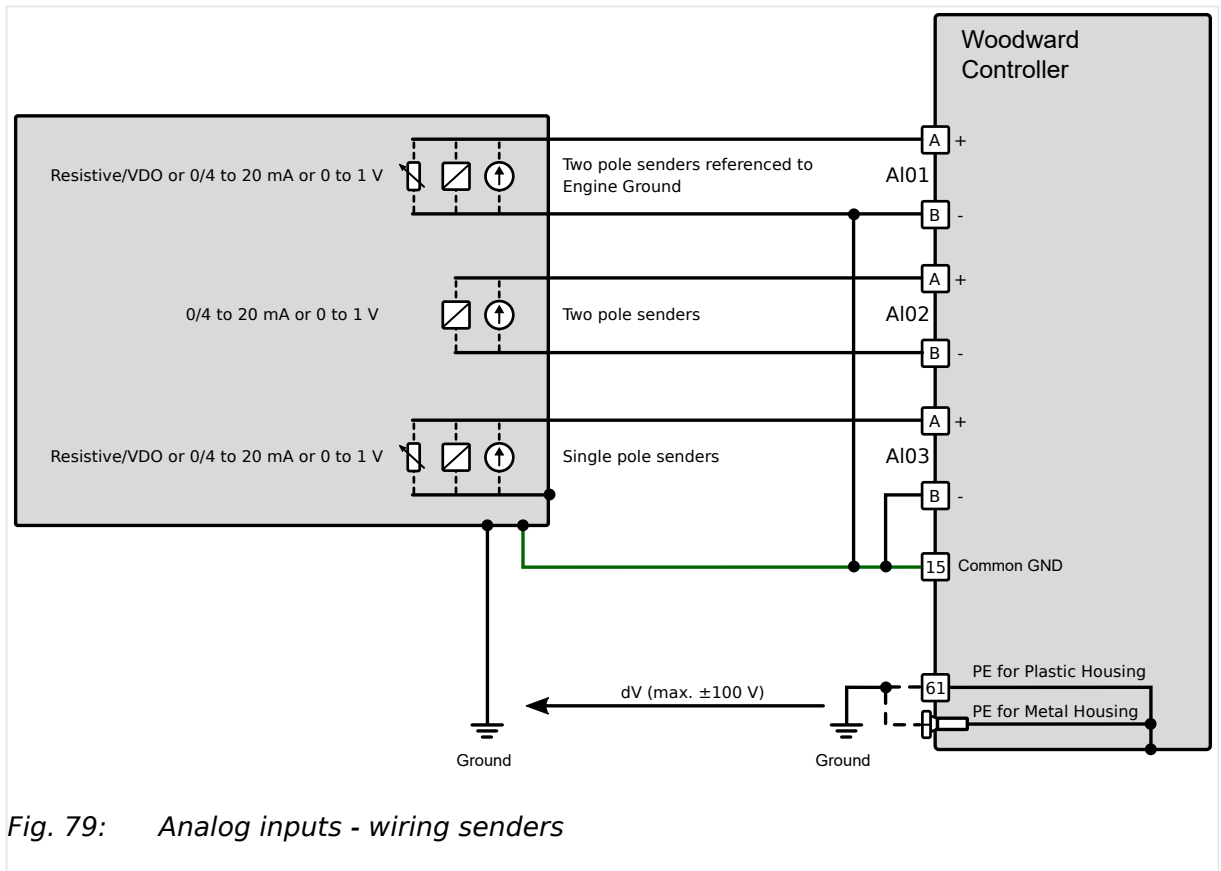

Fig. 79: Analog inputs - wiring senders

Terminal			Description
AI01	A	10	Analog input [AI 01 +]
	B	9	Analog input [AI 01 -] ground, connect with Engine ground terminal 15
AI02	A	12	Analog input [AI 02 +]

Terminal			Description
	B	11	Analog input [AI 02 -]
AI03	A	14	Analog input [AI 03 +]
	B	13	Analog input [AI 03 -] ground, connect with Engine ground terminal 15

CAUTION!**Mixed senders**

When both types resistive sender **and** single pole sender are connected to the device, connection from *minus* (pins 9, 11, 13) should be made with short wire to the Engine Ground (pin 15) on input connector.

Wiring single and two-pole senders simultaneously

It is possible to combine single- and two-pole senders but with the lower accuracy.

3.3.12.2 Analog Inputs (0/4 to 20 mA | 0 to 10 V)

It is recommended to use two-pole analog senders for best possible accuracy (see [8.3 Accuracy](#) for details).



Connect the return wires (GND) to PE on the housing (terminal 61; depends on version) or engine ground (terminal 16; for single-pole senders) as close to the terminals as possible.

The following curves may be used for the analog inputs AI 04-AI 06:

- Table B
- Table A
- Linear

The 9 setpoints of the free configurable Tables A and B can be selected for Type definition (parameters 4310, 4321, and 4332).

Terminal			Description
A	83		Analog input [AI 04]: -
B	84		Analog input [AI 04]: jumper for current measurement
C	85		Analog input [AI 04]: +
A	86		Analog input [AI 05]: -
B	87		Analog input [AI 05]: jumper for current measurement
C	88		Analog input [AI 05]: +
A	89		Analog input [AI 06]: -
B	90		Analog input [AI 06]: jumper for current measurement
C	91		Analog input [AI 06]: +

3 Installation

3.3.12.2 Analog Inputs (0/4 to 20 mA | 0 to 10 V)

Wiring two-pole senders

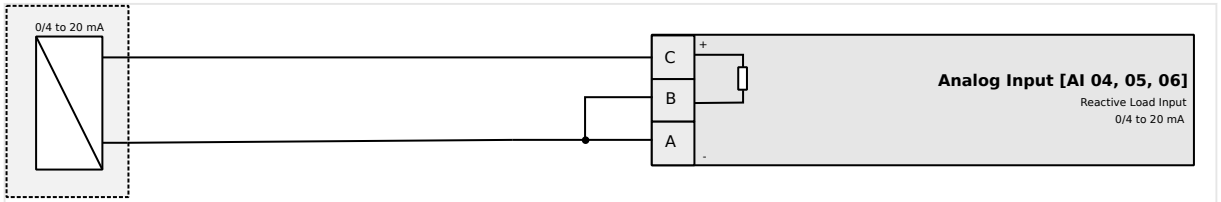

Fig. 80: Wiring two-pole senders for mA input

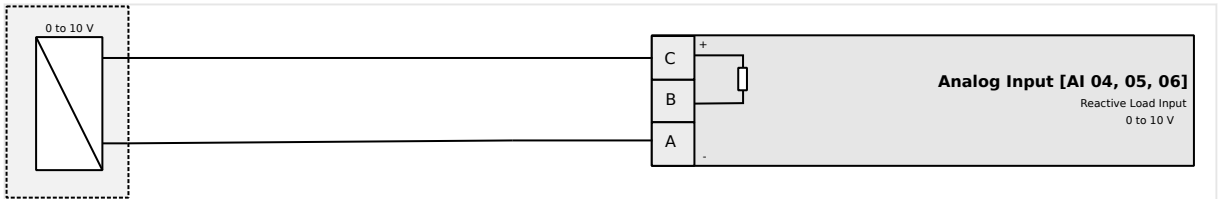

Fig. 81: Wiring two-pole senders for V input

Wiring single-pole senders

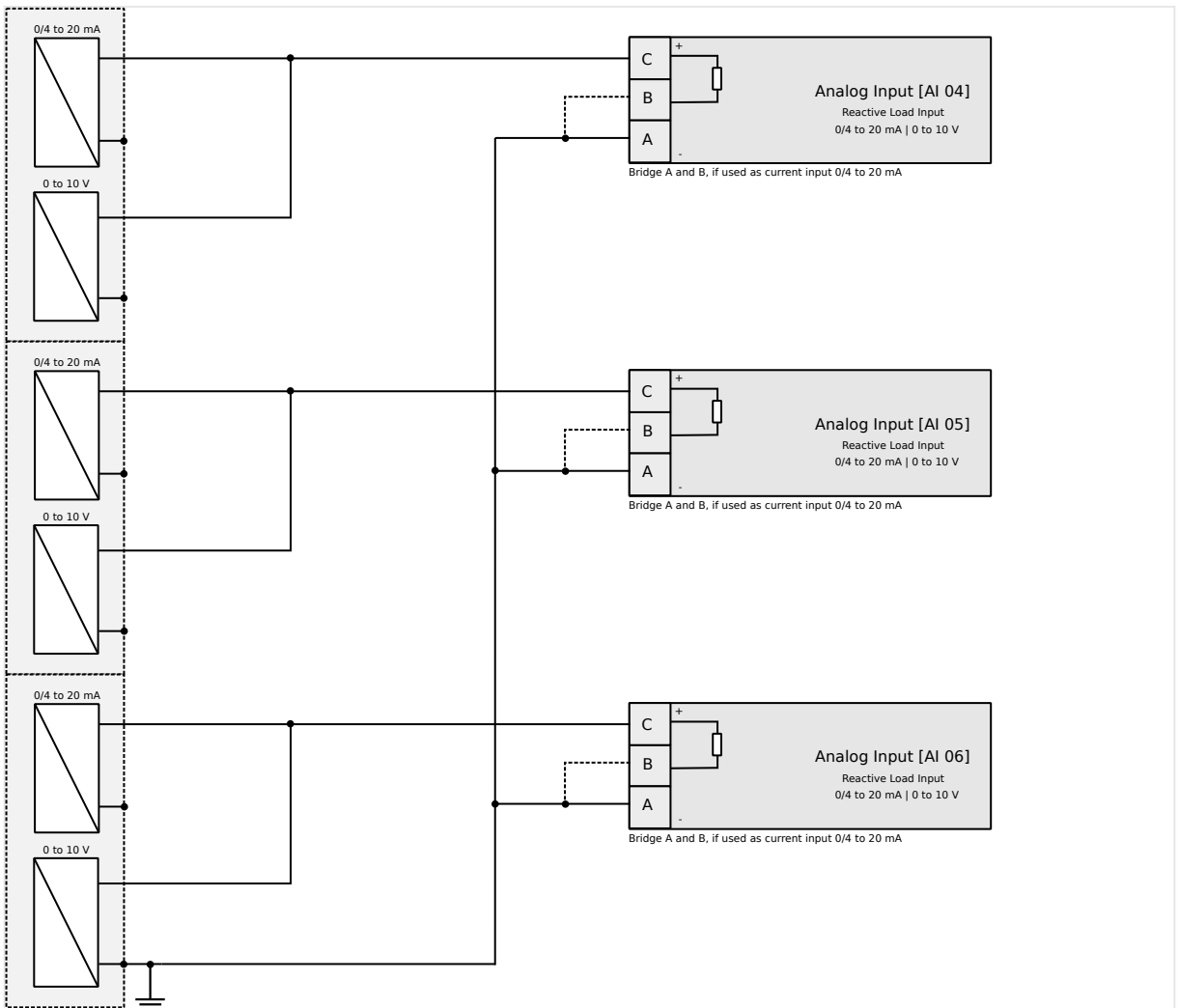

Fig. 82: Wiring single pole senders for mA and/or V input

The specified accuracy for single-pole sensors can only be achieved if the differential voltage between the genset chassis ground and PE does not exceed ± 2.5 V.

Wiring single-pole and two-pole senders simultaneously

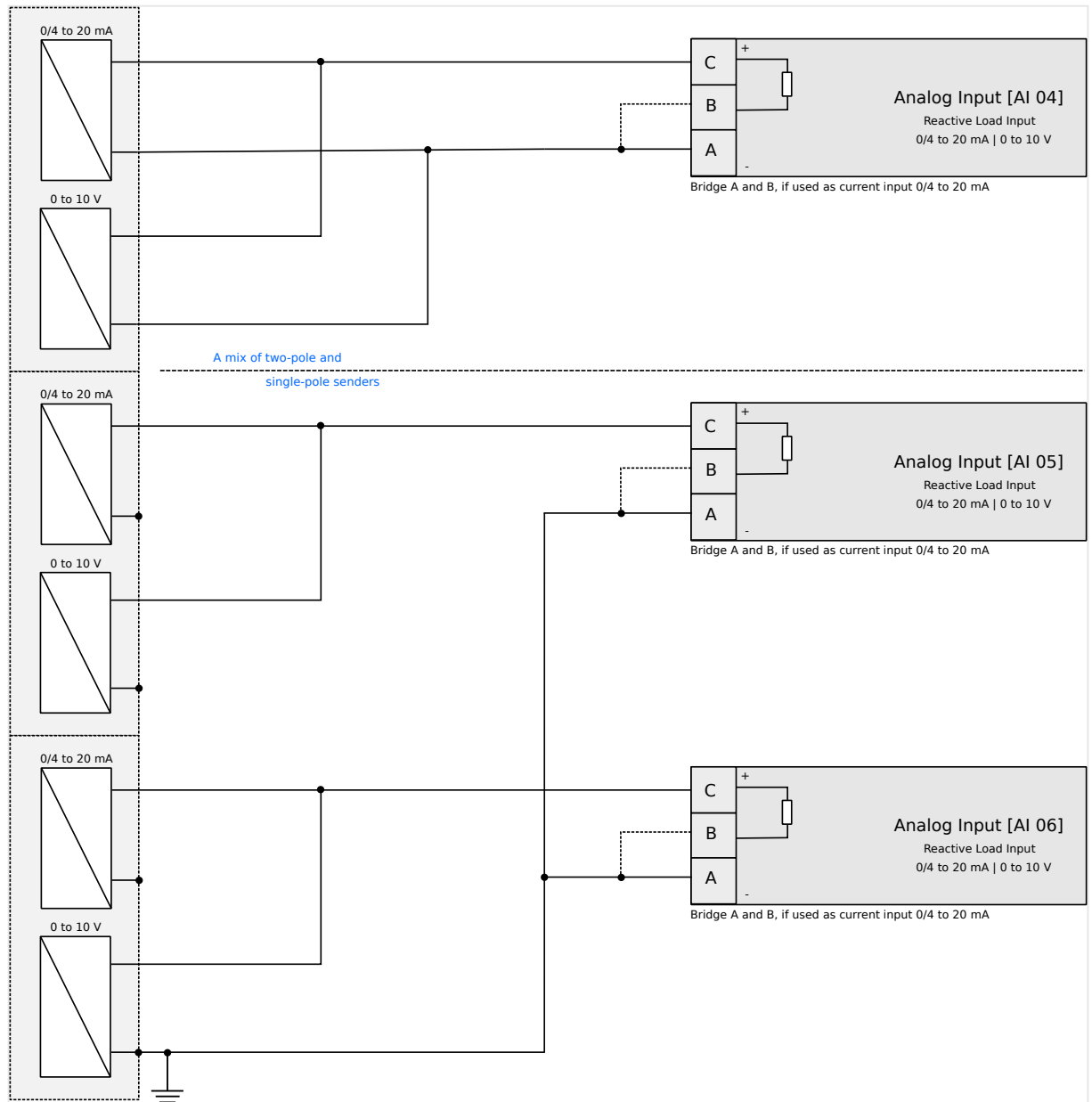

Fig. 83: Wiring two-pole senders for mA (1x) and/or V (2x) input

It is possible to combine single- and two-pole senders but with the lower accuracy. The specified accuracy for single-pole sensors can only be achieved if the differential voltage between the genset chassis ground and PE does not exceed ± 2.5 V.

3.3.12.3 Analog Inputs (0 to 250 Ohms | 0 to 2500 Ohms)

These analog inputs AI 07-AI 10 are designed for resistive senders (RTDs) and can be connected in two or three wire technique.

3 Installation

3.3.12.3 Analog Inputs (0 to 250 Ohms | 0 to 2500 Ohms)



The resistive senders must be isolated to provide a correct measurement.

The following curves may be used for the analog inputs:

- AB 94099
- Table B
- Table A
- Linear
- Pt1000
- Pt100
- VDO 120° C
- VDO 150° C
- VDO 10 bar
- VDO 5 bar

The 9 setpoints of the free configurable Tables A and B can be selected for Type definition (parameters 4343, 4354, 4365, and 4376).



For details refer to manufacturer specification.

Terminal		Description
A	92	Analog input [AI 07, 1]
B	93	Analog input [AI 07, 2]: to compensate voltage drop over long wires
C	94	Analog input [AI 07, 3]
A	95	Analog input [AI 08, 1]
B	96	Analog input [AI 08, 2]: to compensate voltage drop over long wires
C	97	Analog input [AI 08, 3]
A	98	Analog input [AI 09, 1]
B	99	Analog input [AI 09, 2]: to compensate voltage drop over long wires
C	100	Analog input [AI 09,3]
A	101	Analog input [AI 10, 1]
B	102	Analog input [AI 10, 2]: to compensate voltage drop over long wires
C	103	Analog input [AI 10, 3]

Three wire connection

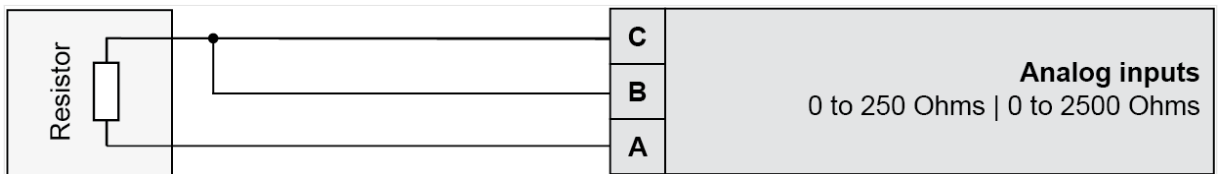

Fig. 84: Wiring three wire connection

The idea of the three wire connection is to subject the voltage drop over the wires leading to the sender. The principle is based on the assumption that the three wires have the same length and diameter. The easYgen subjects the voltage drop over the wiring with the connection C (see [Fig. 84](#)). This connection type makes sense, when the wire resistor is near to the resistive measurement delta (i.e. Pt100).

Two wire connection

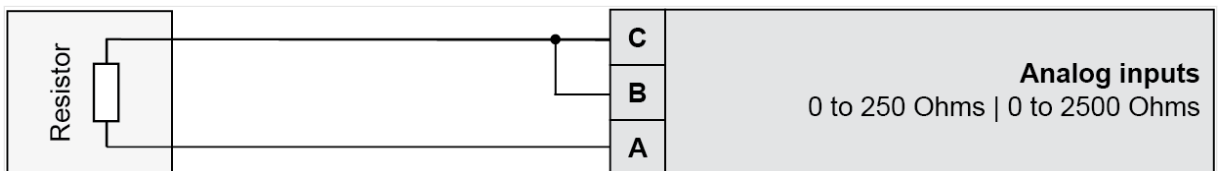

Fig. 85: Wiring two-wire connection

The two wire connection is used when the voltage drop over the wiring does not have much impact on the measurement signal (i.e. Pt1000). A bridge is executed directly on terminals B, C.

3.3.13 Analog Outputs

The easYgen offers current, voltage or PWM analog outputs for different applications. Most commonly they are used for speed and voltage biasing.

Controller configuration can change the multifunction controller bias output signals. The analog outputs are galvanically isolated.

3.3.13.1 Analog Outputs (± 20 mA, ± 10 V, PWM)

Controller wiring - two wires



Fig. 86: Analog controller output - two wires

3 Installation

3.3.13.2 Analog Outputs 3 to 6 (0/4 to 20 mA)

CAUTION!



Connecting external power sources to the analog outputs may damage the device.



In case that higher permanent insulation voltages are required than described in the technical data, please install isolation equipment (isolation amplifier) for proper and safe operation.

Type	Terminal			Description
I Current or V* Voltage	A	16	+	Analog output [AO 01]
	B	17	GND	
(Don't connect terminal 18!)				
I Current or V* Voltage	A	19	+	Analog output [AO 02]
	B	20	GND	



*) Internal shunt (resistor) is managed automatically.

3.3.13.2 Analog Outputs 3 to 6 (0/4 to 20 mA)

Controller wiring

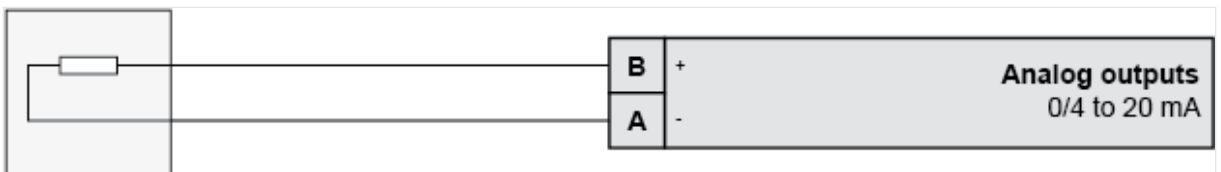

Fig. 87: Analog controller output 4 to 6 - wiring

Type	Terminal			Description
0 to 20 mA or	A	107	-	Analog output [AO 03]

Type	Terminal			Description
4 to 20 mA	B	108	+	
0 to 20 mA or 4 to 20 mA	A	109	-	Analog output [AO 04]
	B	110	+	
0 to 20 mA or 4 to 20 mA	A	111	-	Analog output [AO 05]
	B	112	+	
0 to 20 mA or 4 to 20 mA	A	113	-	Analog output [AO 06]
	B	114	+	



This analog outputs can be used for 0..10 V output by connecting an external 500 Ohms shunt resistor.

3.3.14 Transistor Outputs

The transistor outputs can be used for driving counter pulses like kWh or kvarh.

CAUTION!



Overload will damage the (output) electronics! The max. valid load is 300 mA.

NOTICE!



Woodward recommends protecting the transistor outputs against excessive current with fast-acting fuses rated for 0.315 A.

Controller wiring

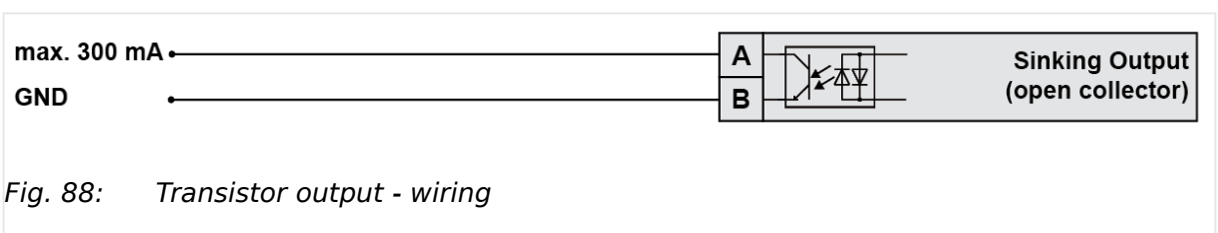

Fig. 88: Transistor output - wiring

Type	Terminal			Description
Sinking Output SO1	A	82		Sinking Output

Type	Terminal			Description
(isolated)				ON: max. 300 mA
	B	81	GND	Emitter (open collector)
Sinking Output SO2 (isolated)	A	154		Sinking Output ON: max. 300 mA
	B	153	GND	Emitter (open collector)

Transistor outputs can be used e.g. for counters (counter pulses). Refer to [“4.10.3 Counter Pulses and Transistor Output”](#) for more details.

3.4 Setup Interfaces

NOTICE!

! **Avoid electrostatic discharge!**

Before working with terminals please read and follow the instructions of chapter [“Electrostatic discharge”](#).

For CAN and RS485 shielded cabling, no more than 25 mm wiring exposed without shield coverage are allowed at terminal plug side.

3.4.1 Interfaces overview

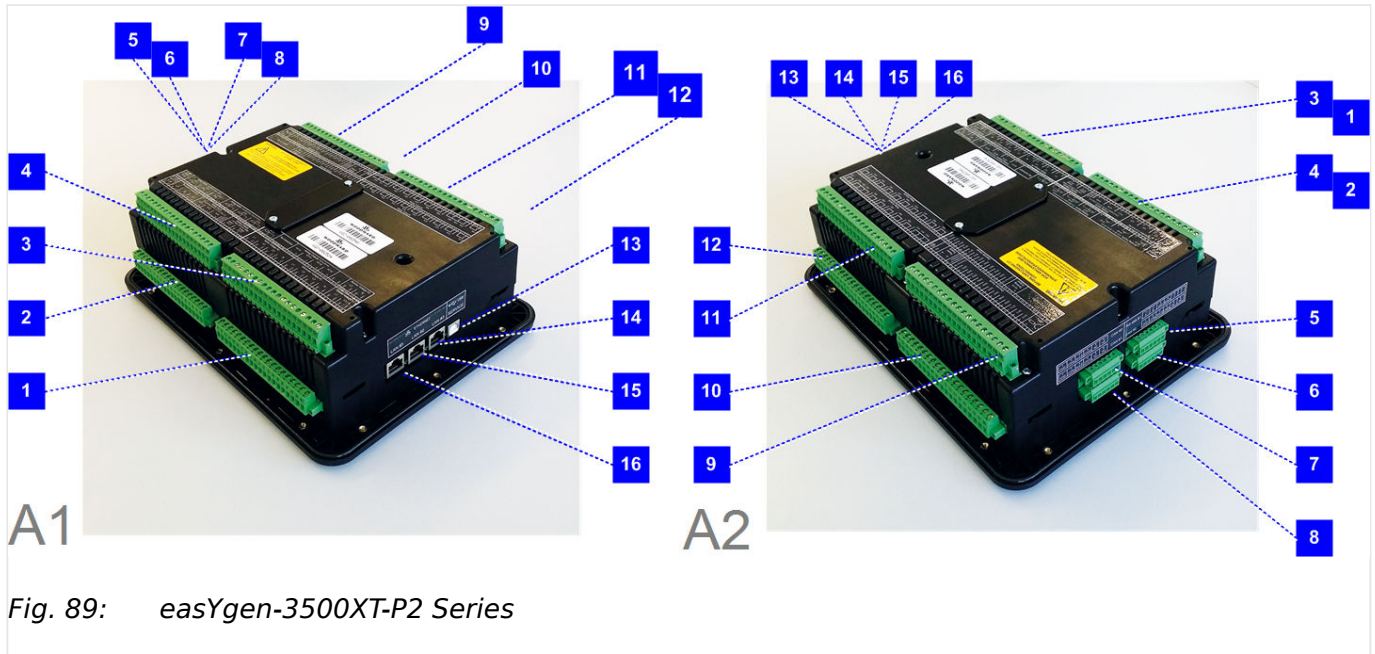

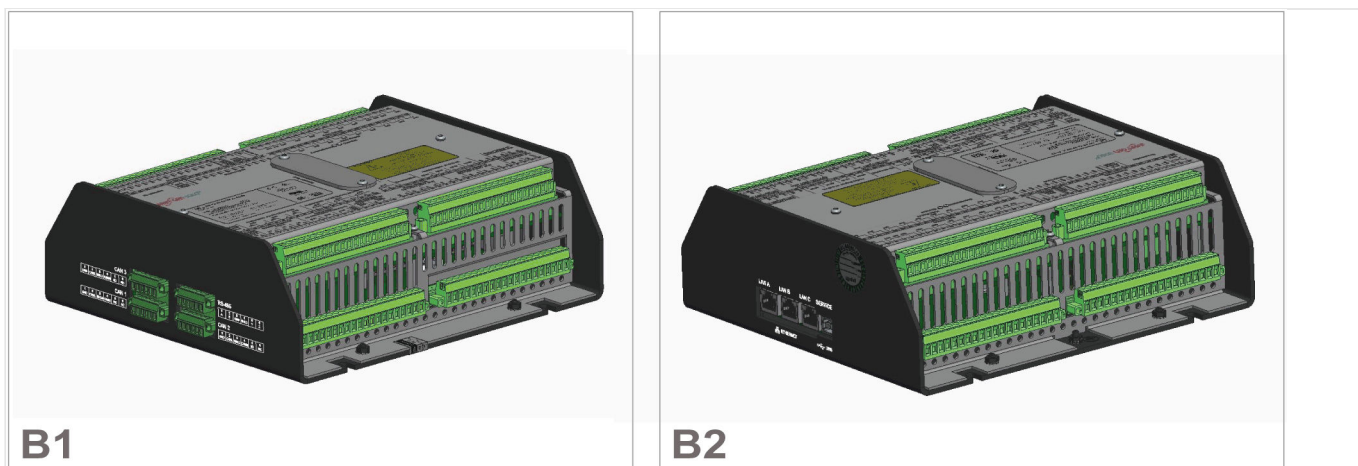

Fig. 90: easYgen-3400XT-P2 Series

- 1 Terminal 21-40: Mains/Generator/Busbar voltage
- 2 Terminal 1-20: Mains/GND current, Generator current, Analog inputs/outputs
- 3 Terminal 101-120: Analog Input 10, Analog Outputs 3-6, Busbar Voltage L3/N
- 4 Terminal 81-100: Transistor Output SO1, Analog Inputs 4-9
- 5 RS-485 interface RS-485 #1
- 6 CAN bus interface CAN #2
- 7 CAN bus interface CAN #3
- 8 CAN bus interface CAN #1
- 9 Terminal 141-160: Discrete Outputs 13-23, Transistor Output SO2
- 10 Terminal 61-80: Discrete inputs, MPU, power supply, and D+
- 11 Terminal 121-140: Relay outputs 13-22
- 12 Terminal 41-60: Relay outputs 01-12
- 13 USB interface (2.0, slave) SERVICE port
- 14 ETHERNET interface (RJ-45) LAN C
- 15 ETHERNET interface (RJ-45) LAN B
- 16 ETHERNET interface (RJ-45) LAN A

3.4.2 RS-485 Interface

General notes



The easYgen must be configured for half- or full-duplex configuration.

Pin assignment

For location of interface 6 see [↪ “3.4.1 Interfaces overview”](#).

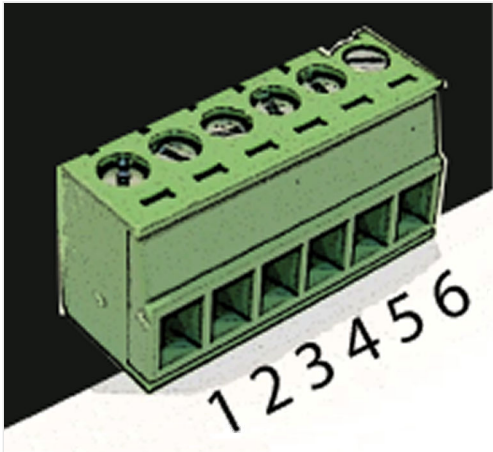

Fig. 91: screwable 6-terminal connector - RS-485

Terminal	Description	.. used for FULL duplex mode	... used for HALF duplex mode	A _{max}
1	A	A (RxD+)		1.5 mm ²
2	B	B (RxD-)		1.5 mm ²
3	GND	GND - local galvanically isolated		1.5 mm ²
4	SHLD	Shield connected to earth via RC element		1.5 mm ²
5	Y	Y (TxD+)	Y (TxD+ / RxD+)	1.5 mm ²
6	Z	Z (TxD-)	Z (TxD- / RxD-)	1.5 mm ²

Table 28: Pin assignment

RS-485 half-duplex

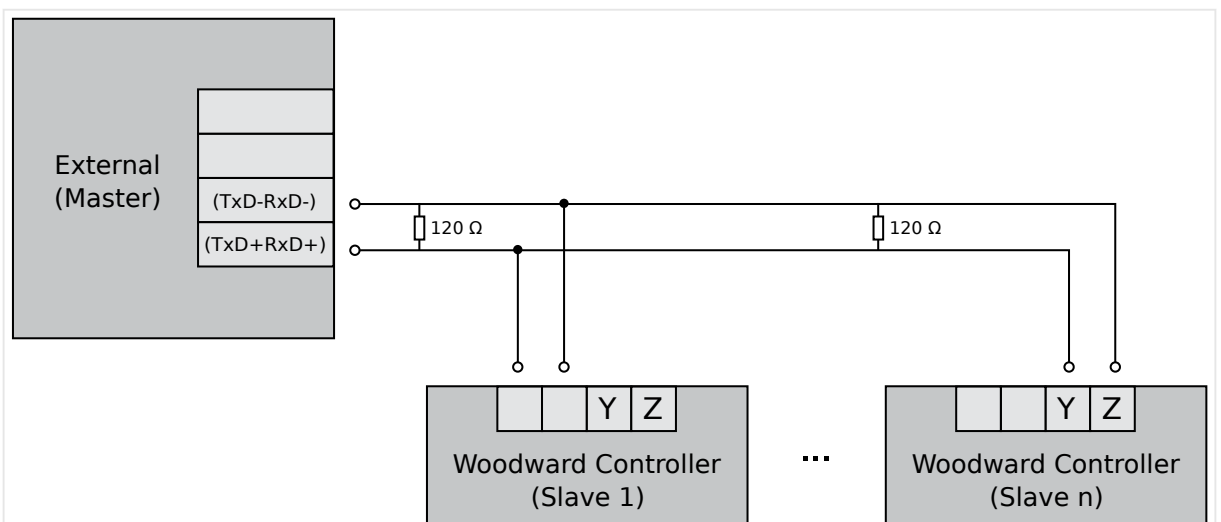

Fig. 92: RS-485 - connection for half-duplex operation (120 Ohms termination resistor at both ends)

RS-485 full-duplex

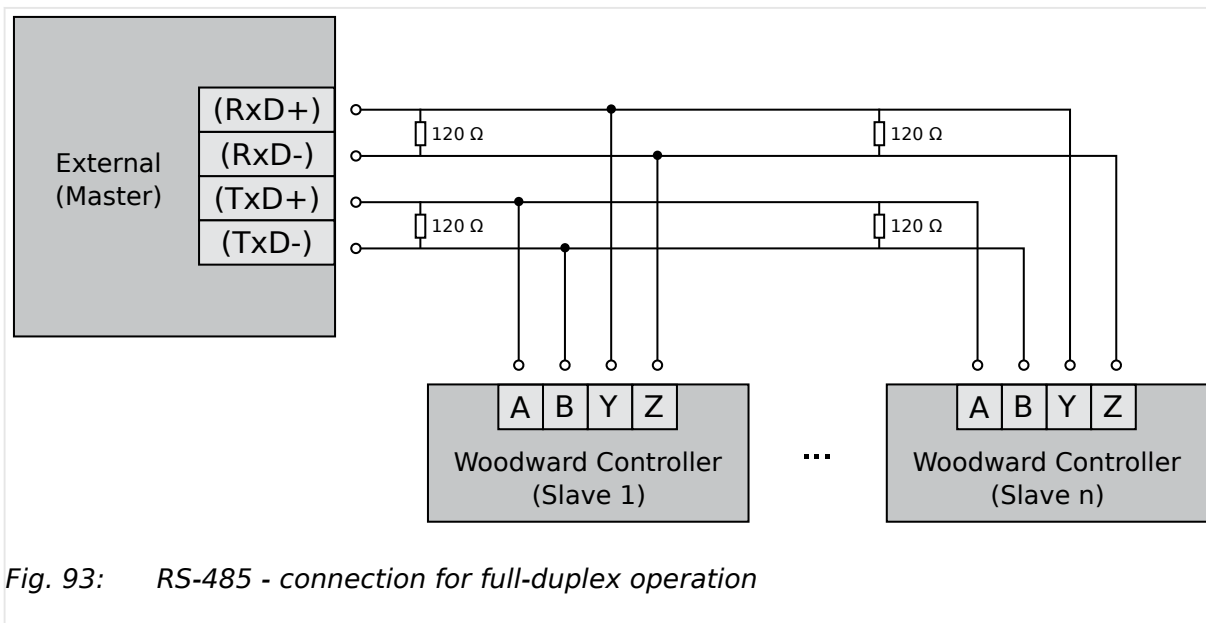

Fig. 93: RS-485 - connection for full-duplex operation

Shielding

easYgen-3000XT is prepared for shielding: Terminal 4 and the connector housing are internally grounded via an RC element. Therefore, they may either be grounded directly (recommended) or also via an RC element on the opposite connection.

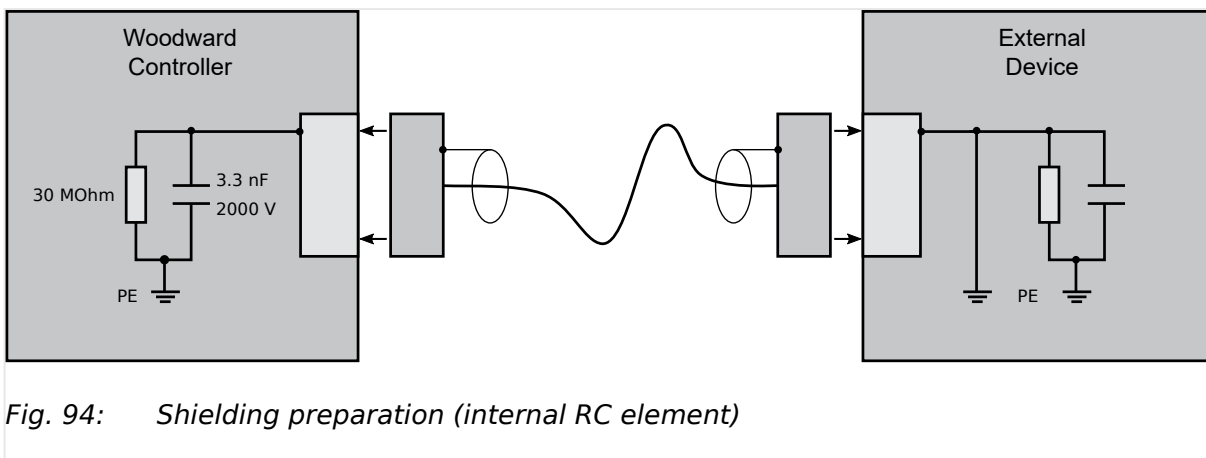

Fig. 94: Shielding preparation (internal RC element)

3.4.3 USB (2.0 slave) interface - Service Port

General notes



Avoid electrostatic discharge!

Avoid electrostatic discharge during USB cable connection to the unit.

i To connect this USB 2.0 (slave) device a USB cable with USB Type A (PC/laptop side) and Type B (Woodward device side) connectors is necessary.

USB cable length shall be limited up to 3 m. It is recommended to use professional (high quality) USB cable: 28AWG/1P+24AWG/2C with good shielding.

i **Use USB service port for ToolKit connection**

The USB interface is a service port and the preferred ToolKit connection!

'Read only' USB interface

For location see [↪ "3.4.1 Interfaces overview"](#).

For others than ToolKit connection the USB interface is read-only!

It can be used for further service tasks from manufacturer's side.

Connecting it to a PC/laptop will display the USB interface available and all files prepared from Woodward manufacturing side. Read/write attributes of this service port are restricted to read only.

3.4.4 CAN Bus Interfaces

i **Avoid electrostatic discharge!**

Avoid electrostatic discharge during cable connection to the unit.

Pin assignment

For location of interface 5, 7, and 8 see [↪ "3.4.1 Interfaces overview"](#).

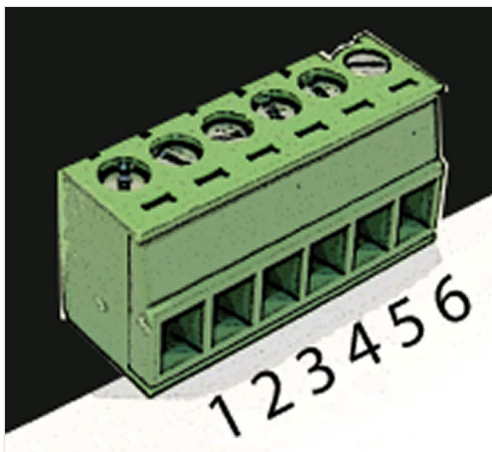

Fig. 95: screwable 6-terminal connector - CAN bus

Terminal	Description	A _{max}
1	GND - local galvanically isolated	1.5 mm ²

Terminal	Description	A _{max}
2	CAN-L	1.5 mm ²
3	Shield	1.5 mm ²
4	CAN-H	1.5 mm ²
5	Not connected	1.5 mm ²
6	Not connected	1.5 mm ²

Table 29: Pin assignment

Topology



Please note that the CAN bus must be terminated with a resistor, which corresponds to the impedance of the cable (e.g. 120 Ω, 1/4 W) at both ends.

The termination resistor is connected between CAN-H and CAN-L.

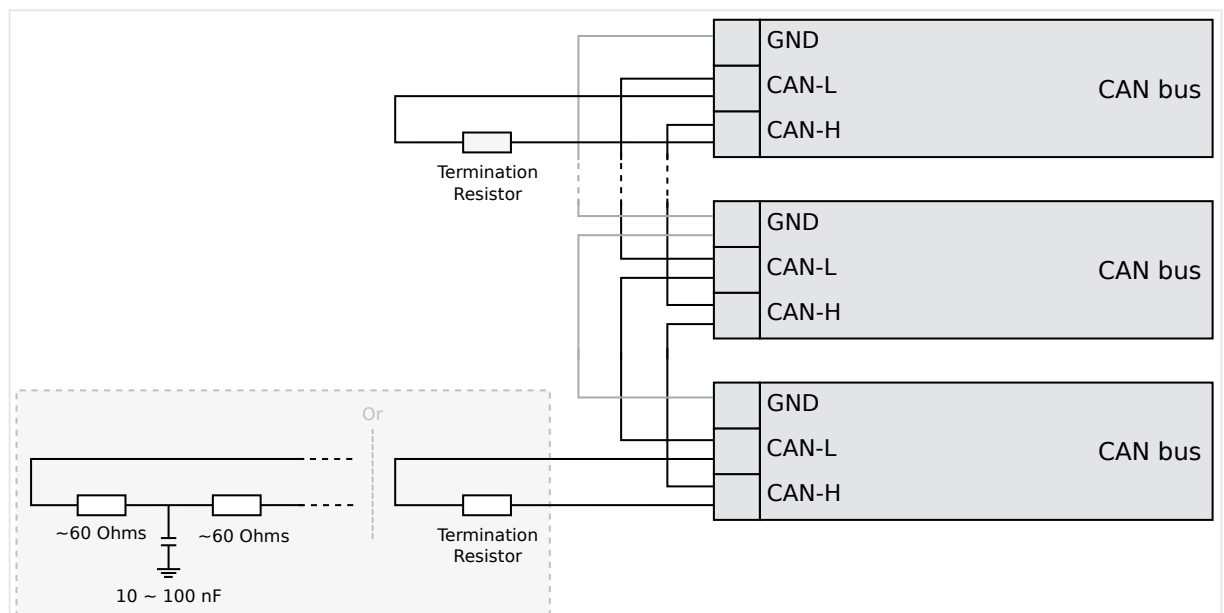

Fig. 96: CAN bus - termination

For very critical EMC conditions (many noise sources with high noise levels) and for high transmission rates we recommend to use the 'Split termination concept' as shown.

- Divide the termination resistance into 2x60 Ohms with a center tap connected to ground via a capacitor of 10 to 100 nF.

Maximum CAN bus length

The maximum length of the communication bus wiring is dependent on the configured baud rate. Observe the maximum bus length.

(Source: CANopen; Holger Zeltwanger (Hrsg.); 2001 VDE VERLAG GMBH, Berlin und Offenbach; ISBN 3-8007-2448-0).

Baud rate	Max. length
1000 kBd	25 m
800 kBd	50 m
500 kBd	100 m
250 kBd	250 m
125 kBd	500 m
50 kBd	1000 m
20 kBd	2500 m

Bus shielding

All bus connections of the easYgen are internally grounded via an RC element. Therefore, they may either be grounded directly (recommended) or also via an RC element on the opposite bus connection.

A shielded cable with shielded plug is required.

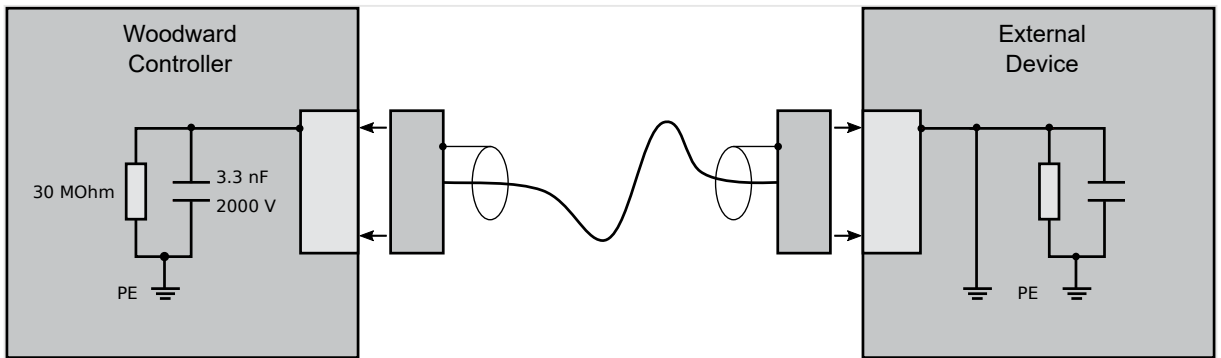

Fig. 97: Bus shielding (internal RC element)

Troubleshooting



If there is no data transmission on the CAN bus, check for the following common CAN bus communication problems:

- A T-structure bus is utilized
- CAN-L and CAN-H are switched
- Not all devices on the bus are using identical baud rates
- Termination resistor(s) are missing
- The configured baud rate is too high for wiring length
- The CAN bus cable is routed in close proximity with power cables



Woodward recommends the use of shielded, twisted-pair cables for the CAN bus (see examples).

- Lappkabel Unitronic Bus CAN UL/CSA
- UNITRONIC-Bus LD 2×2×0.22

3.4.5 Ethernet Interface (incl. Remote Panel)

This Ethernet interface 10/100Base-T/-XT complies with the IEEE 802.3 specifications.



Avoid electrostatic discharge!

Avoid electrostatic discharge during Ethernet cable connection to the unit.

Pin assignment

For location of interfaces 10, 11, and 12 see [↳ “3.4.1 Interfaces overview”](#).

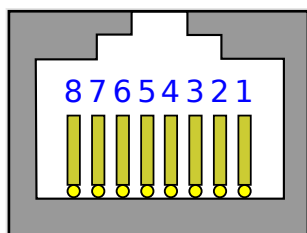

Fig. 98: RJ-45 connector - Ethernet

Pin	Description	10Base-T	100Base-T
1	Transmit Data+	TX+	TX+
2	Transmit Data-	TX-	TX-
3	Receive Data+	RX+	RX+
4	Not connected	NC	NC
5	Not connected	NC	NC
6	Receive Data-	RX-	RX-
7	Not connected	NC	NC
8	Not connected	NC	NC
		Notes	
		NC: Not connected	

Table 30: Pin assignment

Visualization

Two LEDs (green and yellow) indicate communication status as well known by the standard.

- The green LED indicates the link activity: blinking during data transmission.

- The yellow LED indicates the link (speed) status:
 - 10MB - LED switched-OFF
 - 100MB - LED switched-ON

General notes

Ethernet category 5 (STP CAT 5) shielded cable is required with shielded plug RJ45. The chosen switch shall support a transmission speed of 10/100 Mb/s with a network segment expansion capability of 100 m.



Flexibility

All Ethernet ports have auto MDI/MDI-X functionality what allows to connect straight-through or crossover Ethernet cable.

The Ethernet ports are named twice but mean the same: Ethernet #1 or Ethernet A; Ethernet #2 or B; and Ethernet #3 or C .

Cable length / distance

The maximum length from connection to connection is 100 m. Some third party suppliers offer technology to expand the connection.

Topology

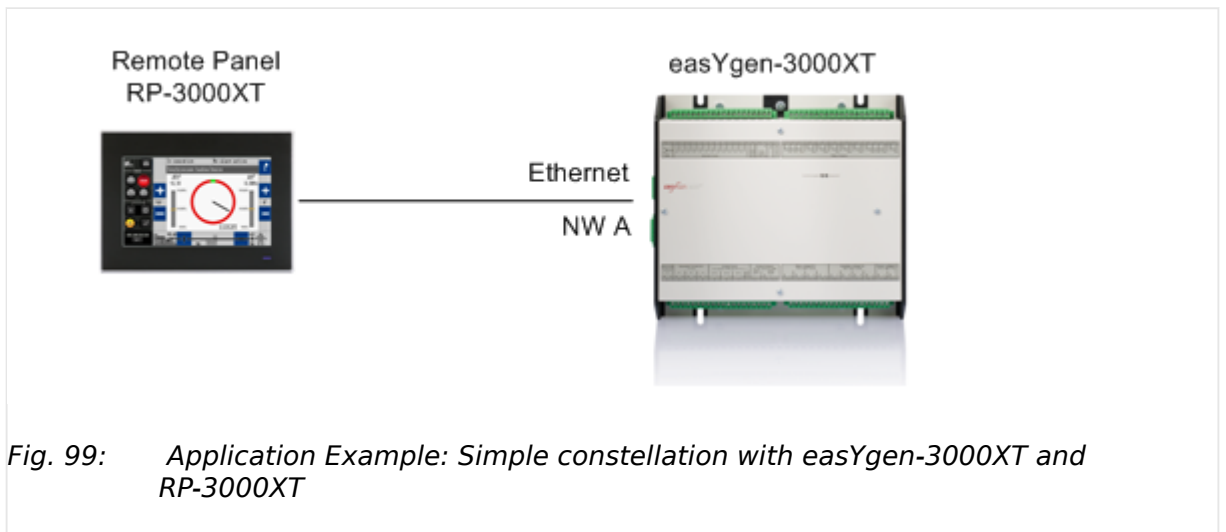

Fig. 99: Application Example: Simple constellation with easYgen-3000XT and RP-3000XT



Remote Control

The Woodward Remote Control is able to visualize the display of the remotely controlled device and to make front button and soft key related functionality available.

Access via Remote Panel PR-3000XT is described in chapter [↪ “4.3.6 Configure Remote Panel Mode”](#) and the Technical Manual [»37593 RP-3000XT«](#).

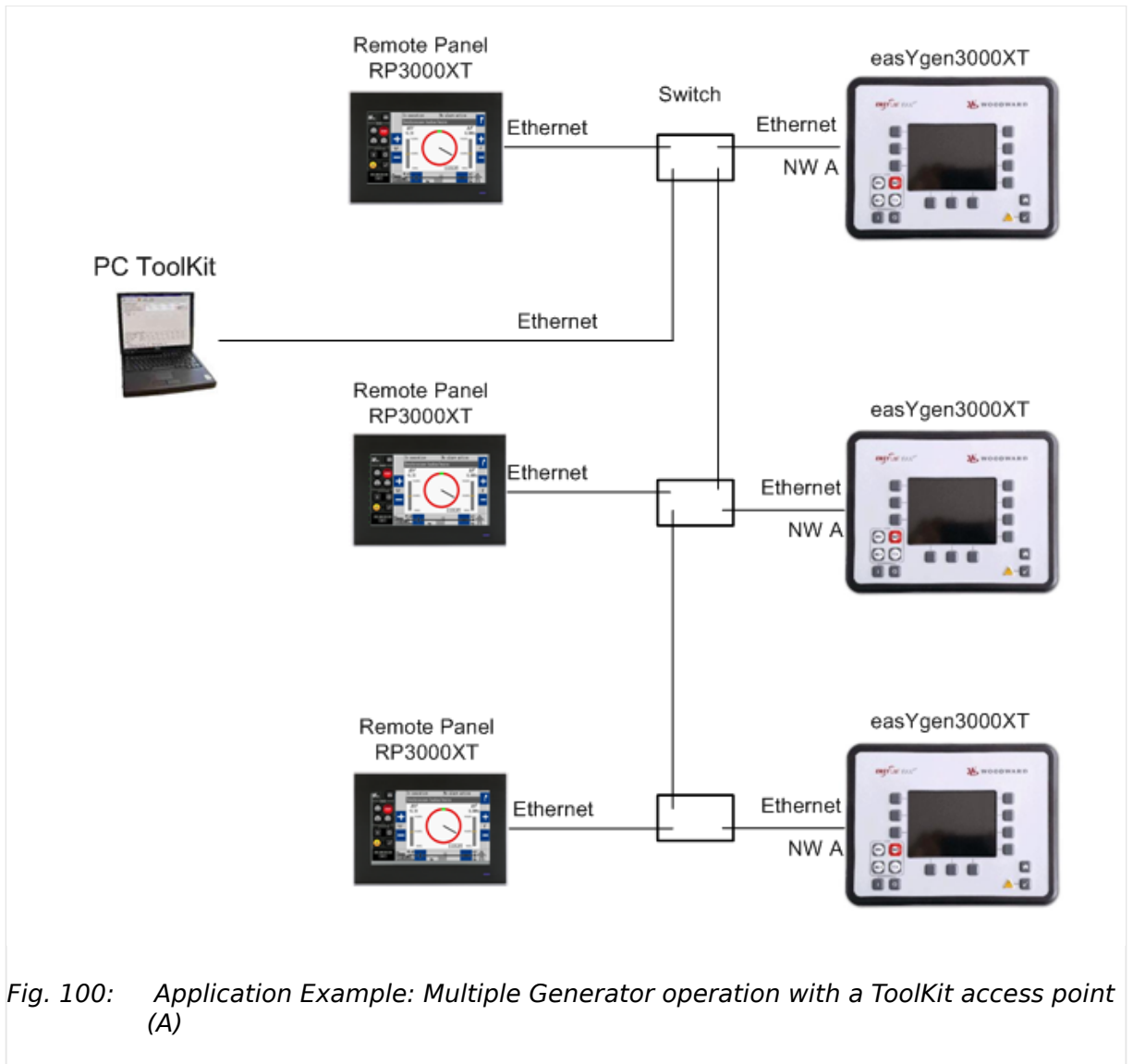

Fig. 100: Application Example: Multiple Generator operation with a ToolKit access point (A)

3 Installation

3.4.5 Ethernet Interface (incl. Remote Panel)

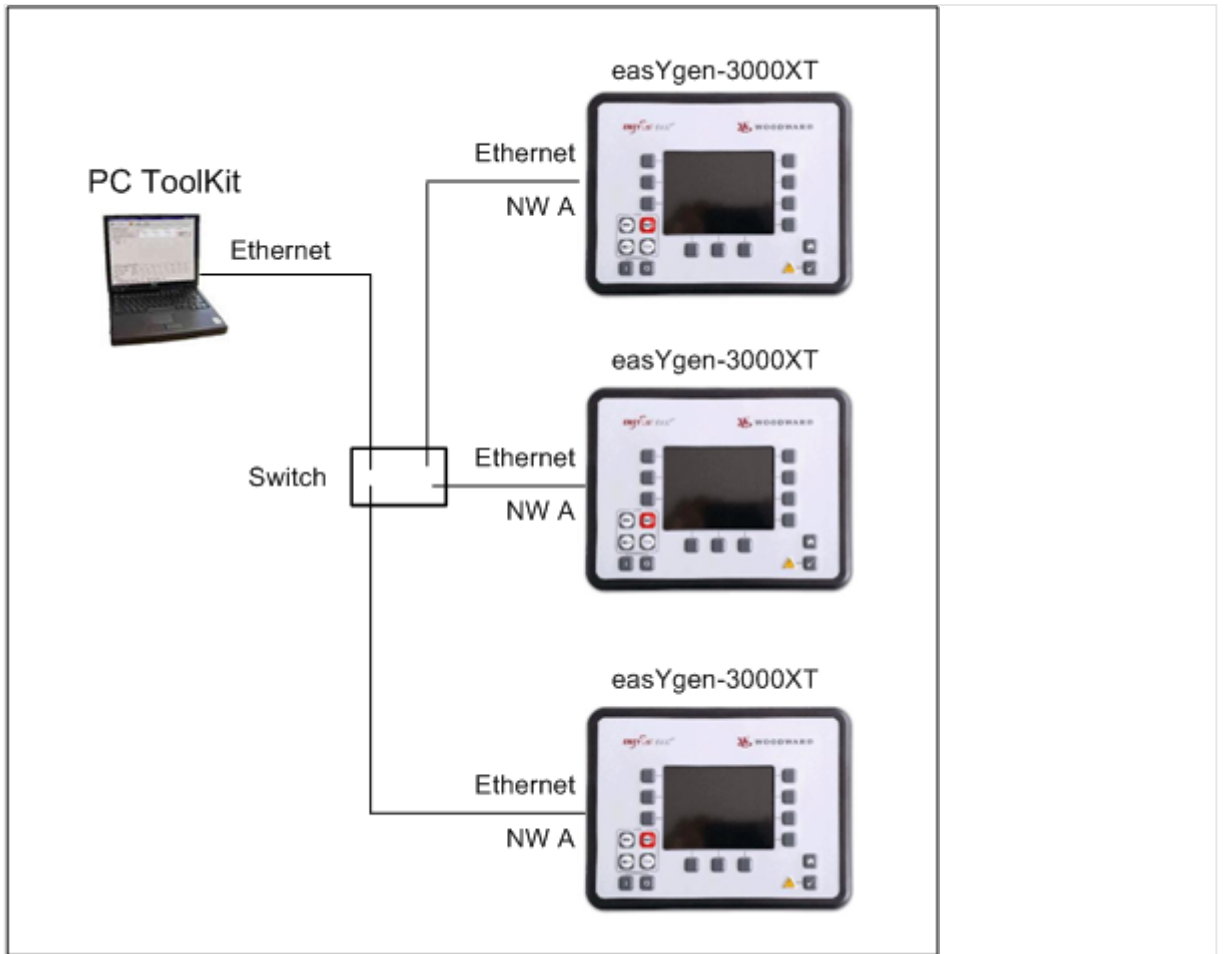

Fig. 101: Application Example: Multiple Generator operation with a ToolKit access point (B)

Troubleshooting

Check first the power supply of the switches.

Check the IP addressed of the single devices. See chapter [4.7.5 Ethernet Interfaces](#) for details.

4 Configuration

Parameter Numbers

All parameters are assigned a unique parameter identification number.

The parameter identification number may be used to reference individual parameters listed in this manual.



This parameter identification number

- is also displayed in the ToolKit configuration screens next to the respective parameter
- can be used with ToolKit "search" functionality
 - to find all ToolKit screen this parameter appears
 - to directly jump to the preferred ToolKit screen

Values of variables and parameters

This device is working with variables and values in FLOAT format. This allows to handle values by number and exponent.

There is a need to convert FLOAT to INTEGER (32 bit) for common Data Protocols, communication with some PLCs, and for some display restrictions.



Rounding error

Numbers higher than 8388608 come with an rounding error of 0.005% of the number itself.



Displayed restrictions sample

Values of user defined tables ([Parameter / Configuration / Configure application / Configure inputs/outputs / Configure analog inputs / General analog inputs / User defined table A (or User defined table B)]) have an input range from -900000.000 to 900000.000.

Type 12345.678 and ...

- ToolKit display will immediately change to 12345.680 for rounding error
- HMI/display shows 12345.678
- ... independent from where value is typed in (ToolKit or HMI/display)

Handle value and unit separately

Some parameters have a separate definition of value and unit. This flexibility comes with the need to take additional care for factorized units like "k...", "M...", "m...", "μ..." multiplying or dividing the number of the value.



Values and units must fit

Device and software offer a very flexible handling of values with well defined selectable rules. It is on customers responsibility to combine what fits.

From device side it is neither restricted nor controlled to use values in a wrong way.

Configuration and Rebooting



Wait before rebooting

Changing configuration/parameters becomes effective immediately. **To be sure that the changes have been saved internally, wait about 20 seconds before rebooting or disconnecting the power.**

Menu structure (menu tree)

The menu structure of HMI/display and ToolKit is aligned.



Exceptions

- The well introduced HMI/display softbutton »Next Page« is continued but in ToolKit named »STATUS MENU«.

(In ToolKit »Next Page« is used to go to the next page.)

- Some monitoring parameters in HMI/display are in ToolKit placed directly with it's settings e.g.: find 10341 »Freq. dep. derating of power« at

[Next Page / Setpoints / Derating] in HMI/display but

[PARAMETER / Configuration / Configure application / Configure controller / Configure load control / General load control] in ToolKit

- »Sequencing« in HMI/display comes with a separate softbutton - ToolKit offers the information together with others as part of the »States easYgen/ Sequencing« screen.

The following drawing shows the first three (major) levels of easYgen-3400XT-P1/3500XT-P1 menu structure:

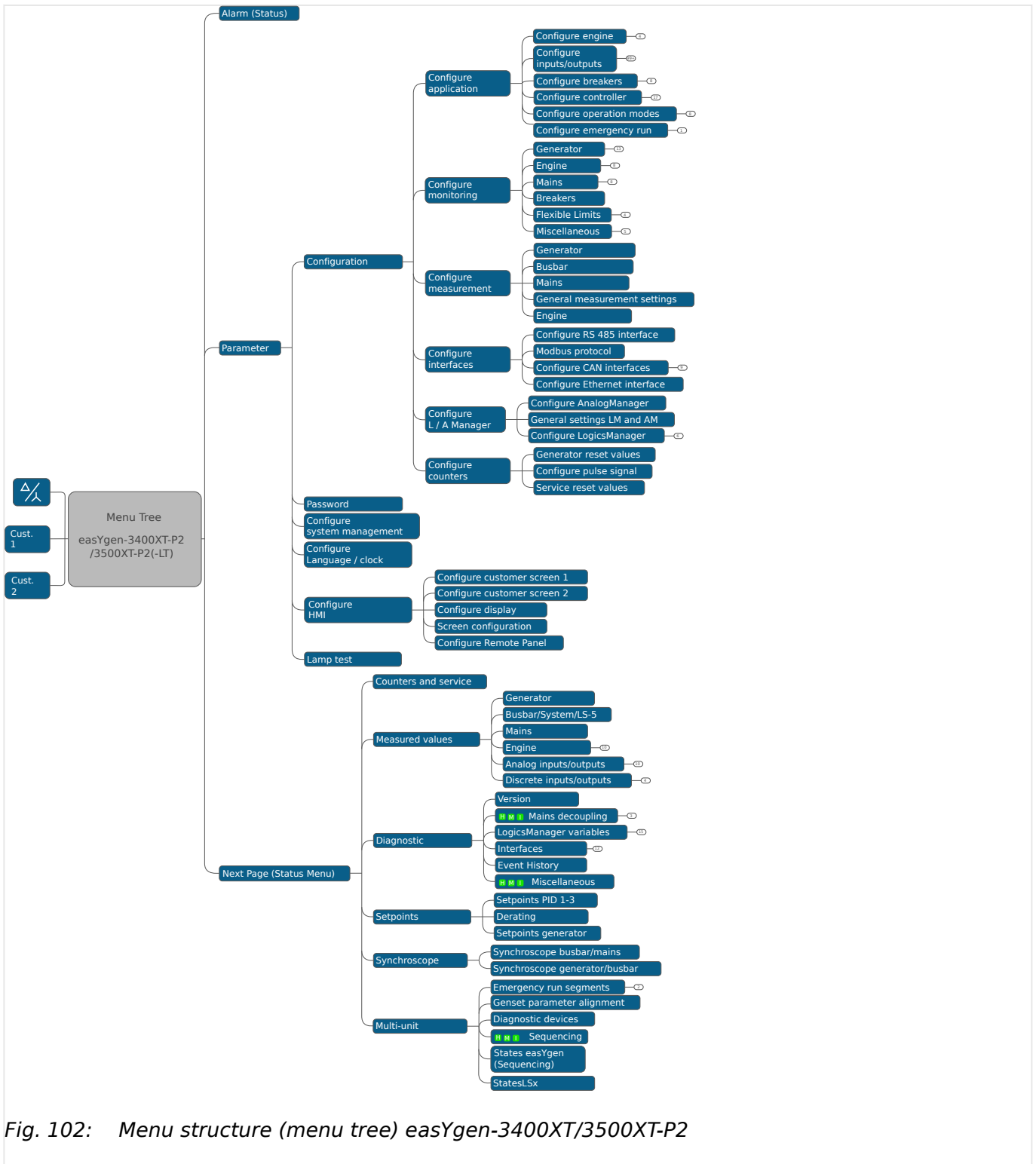



Fig. 102: Menu structure (menu tree) easYgen-3400XT/3500XT-P2

4.1 Front Panel Access



The following chapters only apply to model with front panel and display.

Front Panel / HMI / display

 Buttons can be disabled by ToolKit with parameter \hookrightarrow 12978 »Lock keypad«.

4.1.1 Basic Navigation

Main screen

After power-up the control unit displays the main screen / HOME screen (\hookrightarrow Fig. 103).

The main screen can be divided into the following basic sections:

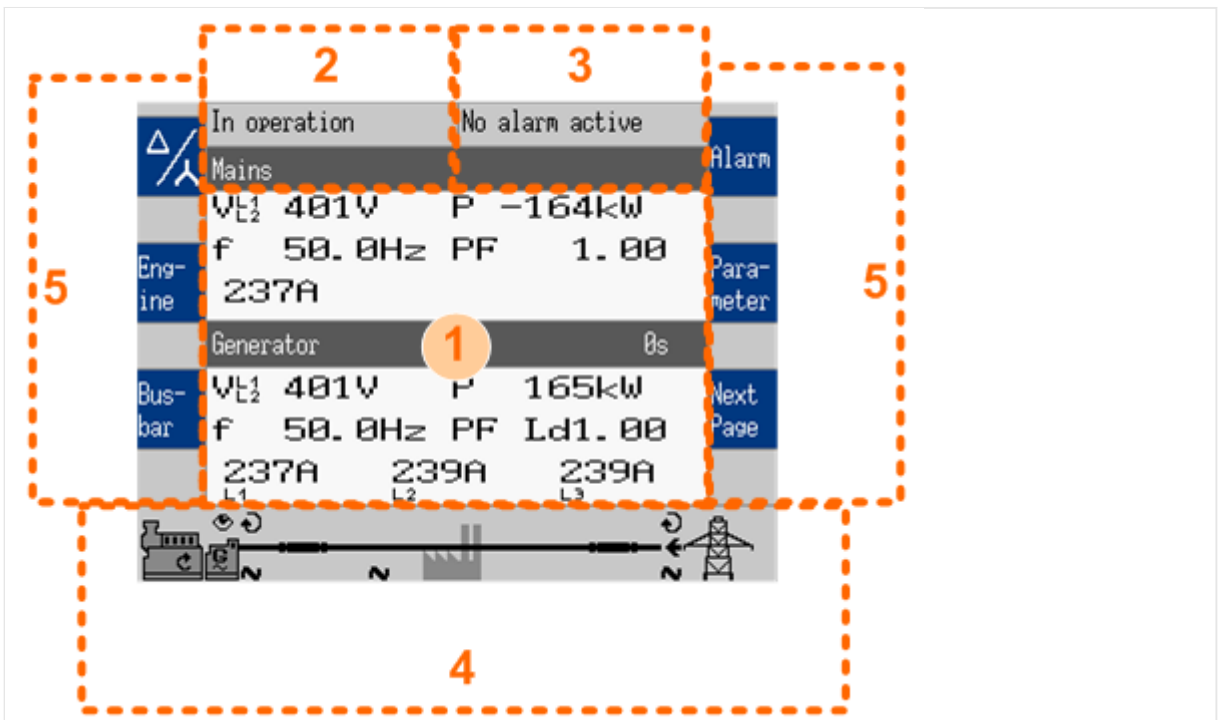

Fig. 103: Main screen (shown with default settings for screen configuration)

- 1 Values
- 2 Status Messages
- 3 Alarm Messages
- 4 Single Line Diagram
- 5 Current Softkey Functions

Values »1«

The "values" section (\hookrightarrow Fig. 103/1) of the screen illustrates all measured power related information including voltages, currents, frequencies, power, and power factor values.



If the mains data display is disabled, the main screen will only show generator data with bigger digits.



The section's content changes based on the selected sub-menu screen.
For information on specialized menu screens refer to [↳ “4.1.5 Specialized Menu Screens”](#)

Status messages »2«

The "status message" section ([↳ Fig. 103/2](#)) of the screen shows the actual operating information.



For a list of all operation states refer to [↳ “9.5.1 Status messages”](#).

Alarm messages »3«

The "alarm message" section ([↳ Fig. 103/3](#)) of the screen shows the "Latest alarm" message that is occurred and not yet acknowledged.

The background color of the latest alarm displayed on the HMI homescreen does not necessarily correspond to the alarm class of the latest alarm. For example, if the latest alarm is alarm class A but there is still an alarm with alarm class F active or latched, the background color is red.



For a list of all alarm messages refer to [↳ “9.5.5 Alarm Messages”](#).

Single line diagram »4«

The single line diagram ([↳ Fig. 103/4](#)) shows the current status of the engine and power circuit breakers.



This section is also used for manual operation of the genset.
For additional information refer to [↳ “5.2.2 Operating Mode MANUAL”](#).















Softkeys »5«

The softkeys ([↳ Fig. 103/5](#)) permit navigation between screens, levels and functions as well as configuration and operation.



Group	Softkey	Caption	Description
Display		Display Mode	Next step to display all measured (delta/wye) voltages one after the other.
		Customer configurable screen 1 (and 2)	Change to "customer specific screen 1 (or 2)"
			Notes







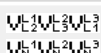











4 Configuration

4.1.1 Basic Navigation

Group	Softkey	Caption	Description
			The name of this softbuttons is configurable, too.
		CAN 1	Change to "CAN interface 1 state" screen.
		CAN 2	Change to "CAN interface 2 state" screen.
		Ext. I/O	Change to external discrete I/Os screen.
		Int. I/O	Change to internal discrete I/Os screen.
		Reset Value Display Reset Maintenance	Reset the maximum value display. Reset the maintenance counter.
Operation		Increase Value	Increase selected value.
		Decrease Value	Decrease selected value.
		Confirm Input	Confirm and store changed value.
		Acknowledge Message	Acknowledge/Delete message/event.
		Open Breaker	Open mains/generator breaker (MANUAL mode).
		Close Breaker	Close mains/generator breaker (MANUAL mode).
		Code req.	Request a blink code for one error message from the ECU. Repeated pressing of this softkey displays all stored error messages (J1939 Special Screen).
		Reset	Reset the blink code (J1939 Special Screen).
Navigation		Move Up	Select previous value/entry.
		Move Down	Select next value/entry.
		Move Cursor Position	Move cursor position
		Return	Return to previous menu.
		Next Page	Go to following page/screen of the current menu.
		Parameter Screen	Show parameter screen.
		Alarm Screen	Show alarm screen.

Status symbols

Menu screen	Symbol	Caption	Description
Main Screen		Voltage Display Mode	The index of the symbol indicates whether delta or wye voltage is displayed and which phases are displayed.
Single Line Diagram		Rotating Field CW	Generator, mains or busbar rotating field moves clockwise.

Menu screen	Symbol	Caption	Description
		Rotating Field CCW	Generator, mains or busbar rotating field moves counter-clockwise.
		Power Detected	Power is detected at the respective measuring point (generator, busbar or mains).
		Monitoring Enabled	Indicates that the engine delayed monitoring has expired and the monitoring functions are enabled.
		Power Imported	Power is imported (at mains interchange).
		Power Exported	Power is exported (at mains interchange).
Alarm List		Alarm Condition Present	Indicates that corresponding alarm condition is still present.
		Alarm Class A - Class F present	Symbol with "!" indicates that an alarm of Class A - Class F is present.
		Alarm Class A - Class F not present	Symbol without "!" indicates that an alarm of Class A - Class F is not present.
Setpoints		Generator Power	Indicates the generator power (actual value).
		Mains Power	Indicates the mains power (actual value).
Synchroscope		Phase Angle	Indicates the actual phase angle between busbar and mains or busbar and generator.
Sequencing		Breaker Closed	GCB of respective genset in sequence is closed.
		Breaker Open	GCB of respective genset in sequence is open.
		Add-on	Generator is becoming "Add-on" to the (multiple) genset system.
		Add-off	Generator is going "Add-off" from the (multiple) genset system.
LogicsManager		Delay ON	Delay before output becomes TRUE.
		Delay OFF	Delay before output becomes FALSE.
		TRUE/enabled	Variable is TRUE (LogicsManager). The bit is enabled (CAN Interface). Relay activated (Discrete Outputs)
		FALSE/disabled	Variable is FALSE (LogicsManager). The bit is disabled (CAN Interface). Relay deactivated (Discrete Outputs)



The following chapters list notes related to the specific menu screens.

For information on standard softkeys and status symbols refer to [↪](#) “4.1.1 Basic Navigation”.

4.1.2 The HOME Screen

General notes

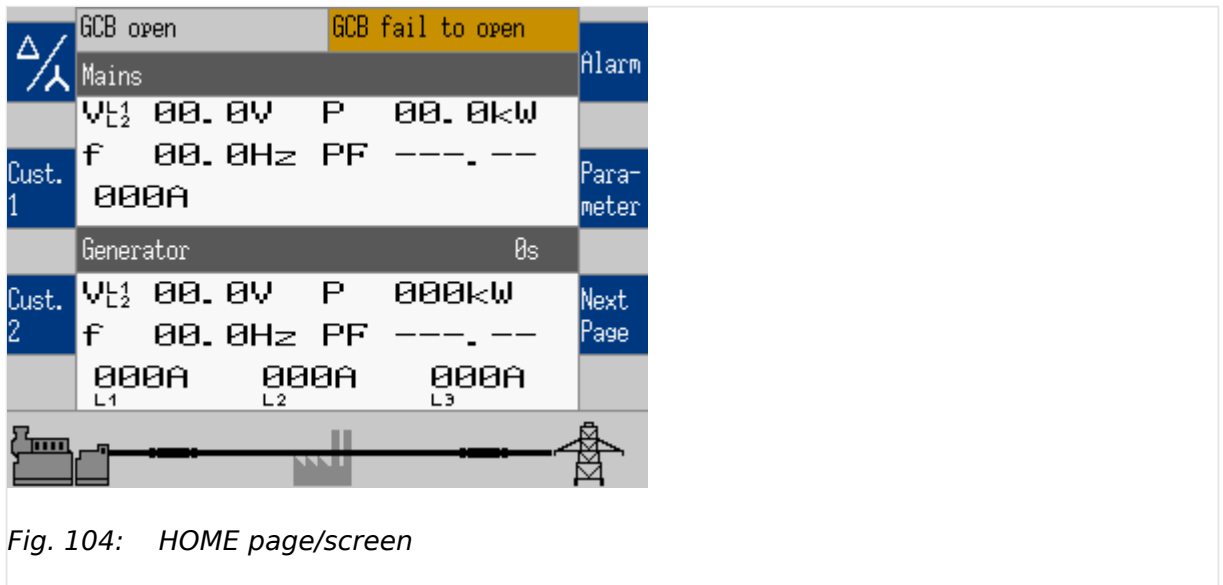

Fig. 104: HOME page/screen

- The “Home” button is a one-click way back to the overview starting point: the HOME page / HOME screen
- The “Home Screen” offers display alternatives via parameter [4103](#)» Home screen data«
 - Generator
 - Generator/Mains
 - Generator/Busbar
 - Generator/Engine
 - Generator/LSx/GC

- To display the single line diagram with/without mains is selectable via parameter [4129](#) »Online diagram with mains«
- **Two customizable buttons** enable selection of indications to display engine and auxiliary values (full access via ToolKit, name/description cannot be changed via HMI)

Find menu: [Parameter / Configure HMI / Configure customer screen 1] and [Parameter / Configure HMI / Configure customer screen 2]

- Two display brightness levels can be switched by LogicsManager. Can be used for e.g.:
 - Key activation determined
 - Brightness reduction on navigation bridge (vessels)
 - Saving energy

Find menu: [Parameter / Configure HMI / Configure display]

- Lock keypad function is determined by LogicsManager  12978. Result is available as logical command variable 86.30.

Find menu (ToolKit only!): [Parameter / Configure HMI / Configure display]

If the result of this LogicsManager is true:







- The device indicates state "Keypad locked" (alternating with other states)
- All operating mode buttons are ignored
- All soft keys for breaker "OPEN"/"CLOSE" are ignored
- The acknowledge of alarms is blocked
- The setpoint access is blocked

(The horn reset and the visualization and configuration screens are still accessible.)

Display alternatives

The HOME screen allows a number of pre-selectable and softbutton controlled display variants.

- Generator
 - Voltages (pp - pn) - selectable via softbutton »1«
 - Power
 - Power Factor PF
 - Frequency
 - Currents (L1, L2, L3)
- Generator/Mains
 - Generator values as described above
and additionally for Mains
 - Voltage
 - Frequency
 - Current
 - Power
 - Power factor
- Generator/Busbar
 - Generator values as described above
and additionally for Busbar
 - Voltage
 - Power

- Frequency
- Generator/Engines
 - Generator values as described above and additionally for Engine
 -  Engine speed (rpm)
 -  Oil pressure (bar or psi)
 -  Water temperature (°C or °F)
 -  Operating hours (h)
 -  Battery voltage (V)
 -  Fuel level (%)
- Generator/LSx/GC
 - Generator values as described above and additionally for mains values measured by LSx or GC, according to application mode (parameter [↩ 3444](#)).
 - Voltage
 - Power
 - Frequency

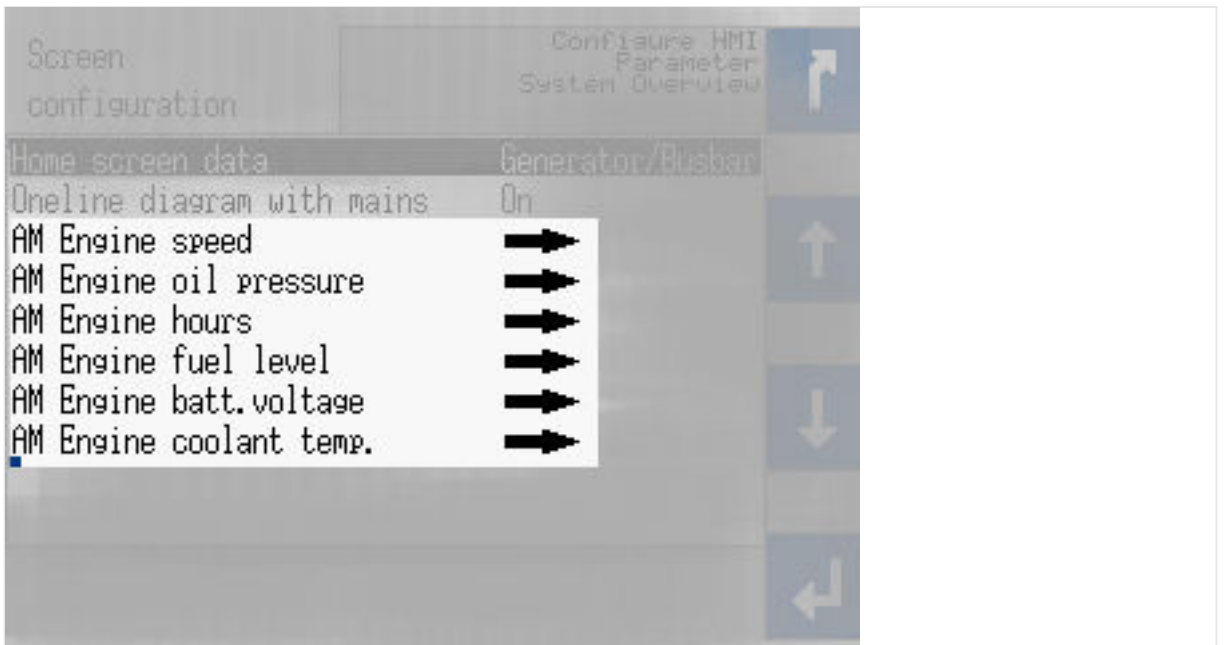

Fig. 105: AnalogManagers for "Engine" values at Home Screen



"Engines" parameter selection

The values to be displayed at "Engines" can be selected via AnalogManager definition of the parameters at [Parameter / Configure HMI / Screen configuration]. Menu texts and symbols cannot be changed!

4.1.3 Customer Screens

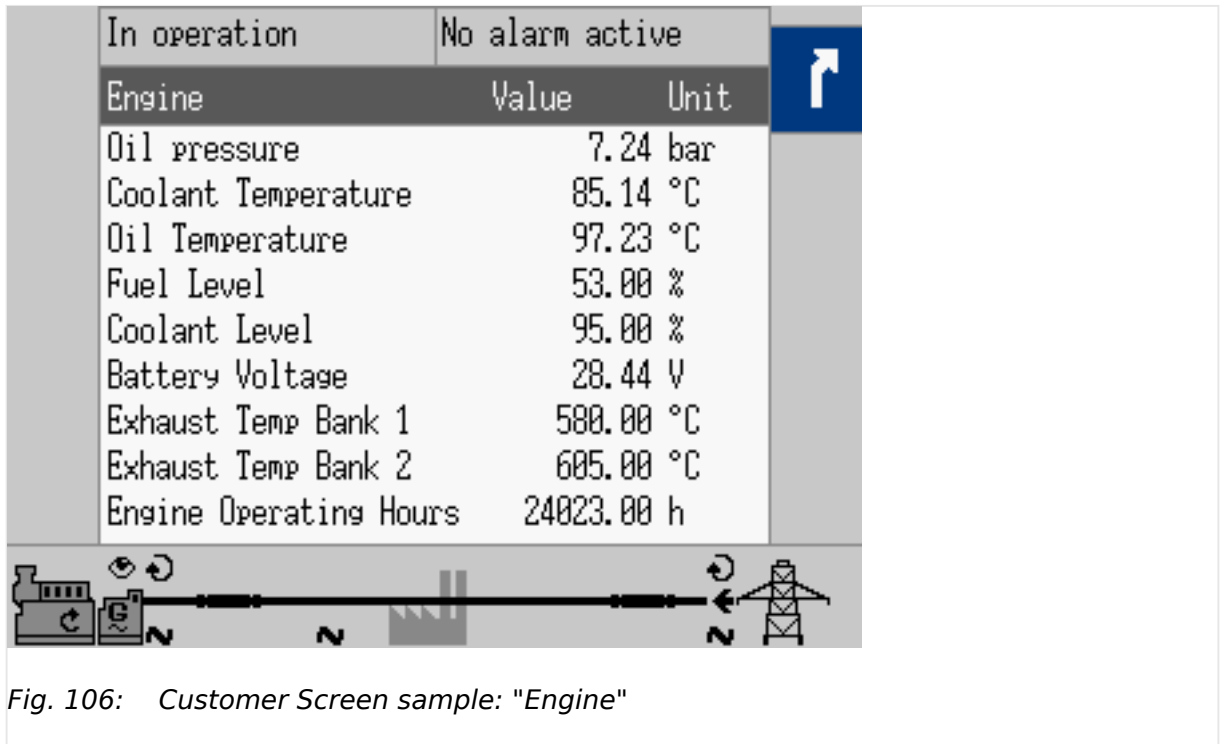

Fig. 106: Customer Screen sample: "Engine"

Available at HOME page, two softbuttons give one-click access to customer specific (monitoring) screens.



Full functionality available via ToolKit. HMI allows access to the AnalogManager but not to the text fields »Description« and »Unit«.

Find menu: [Parameter / Configure HMI / Configure customer screen 1 / AM Customer screen 1.1 - AM Customer screen 1.9],

and [Parameter / Configure HMI / Configure customer screen 2 / AM Customer screen 2.1 - AM Customer screen 2.9],

How to customize screens via ToolKit?

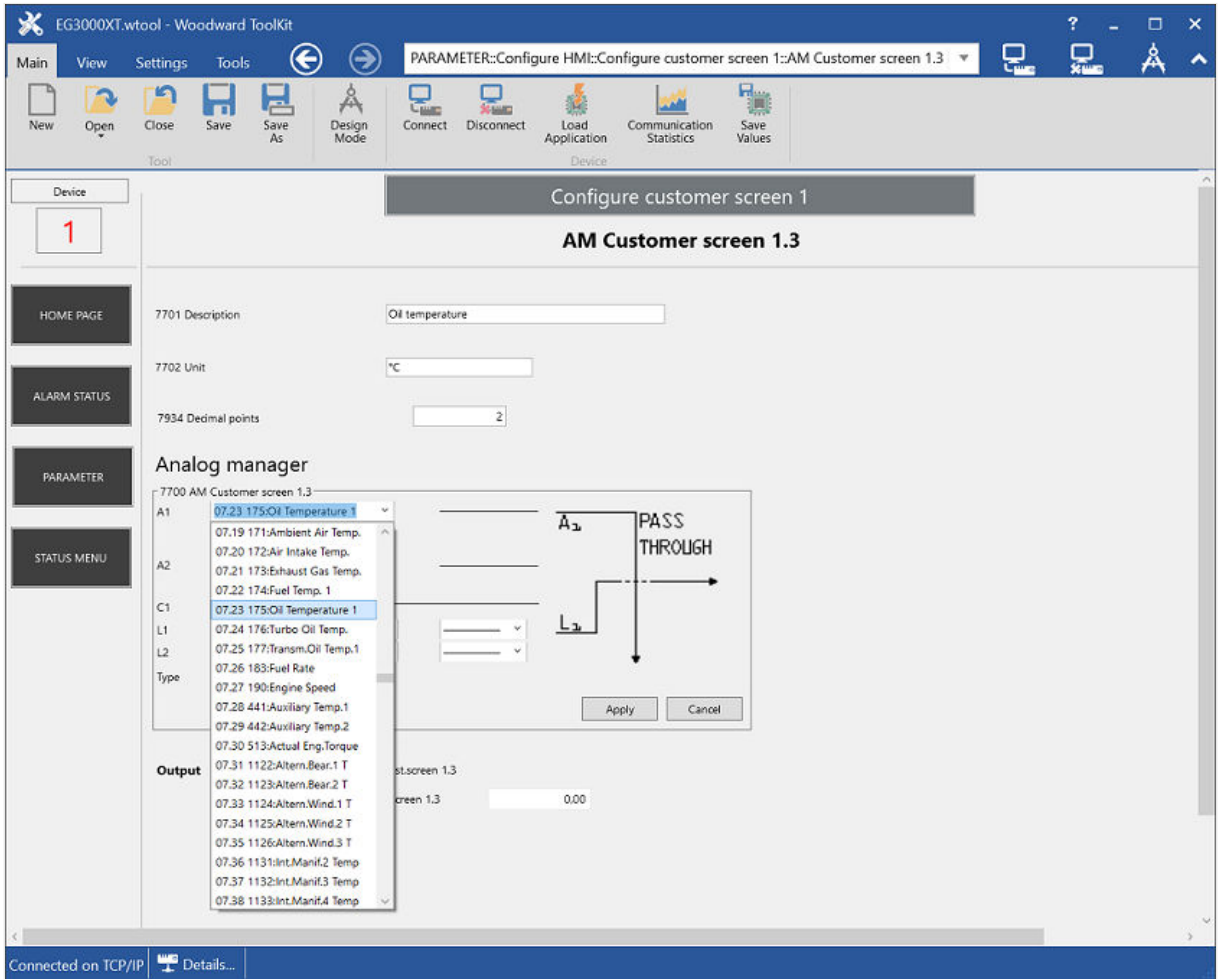



Fig. 107: Customer screen: setting sample

Two customer specific named screens enable flexible configuration of up to 18 values. Each displayed with Description (customer specific text), the result of a free configurable AM, and (a customer specific text for) Unit.

Customize via	Parameter	Description
Configure homepage button names for screen 1 and screen 2:		
Screen/button Name	14895, 14897	Button text, displayed at easYgen-XT HMI homepage
		<p>Notes</p> <p>The display allows two rows with five letters each. Use <WBR> for row separator because a blank is taken as one letter.</p> <p>If the text is too long it will not be visible and an "empty/clear button" will appear! We propose to check input immediately by refreshing home screen.</p>
Configure each row of the customer screens with:		
Description	7691, 7696, 7701, ..., 7776	Text displayed

Customize via	Parameter	Description
		
Value	AM 7690, 7695, 7700, ..., 7775	AnalogManager to select parameter for display. Additionally available via  , too.
Unit	7692, 7697, 7702, ..., 7777	Text displayed

4.1.4 Standard Menu Screens



The following chapters list standard menu screens, where all user input is handled similarly.

For information on standard softkeys and status symbols refer to [↪ “4.1.1 Basic Navigation”](#).

For information on all other menu screens refer to [↪ “4.1.5 Specialized Menu Screens”](#).

4.1.4.1 Navigation Screens

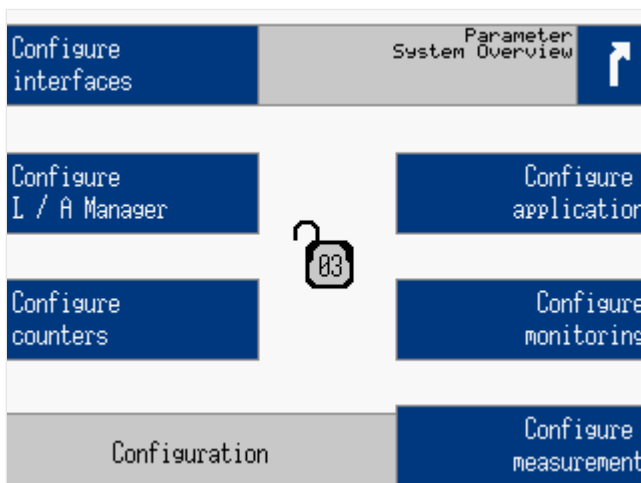

Fig. 108: Navigation screen (example)

Navigation screens offer access to sub-menu screens via the displayed softkey.

Navigation screens samples:

Parameter, Configuration, Measured values, Synchroscope, Engine (J1939), Diagnostic ...



1. ▷ Press the desired softkey to change to a sub-menu screen.



Sub-menu entries are only displayed if the code level needed to access them is the same/or higher than the displayed code level in the center of the navigation screen.

4.1.4.2 Value Setting Screens

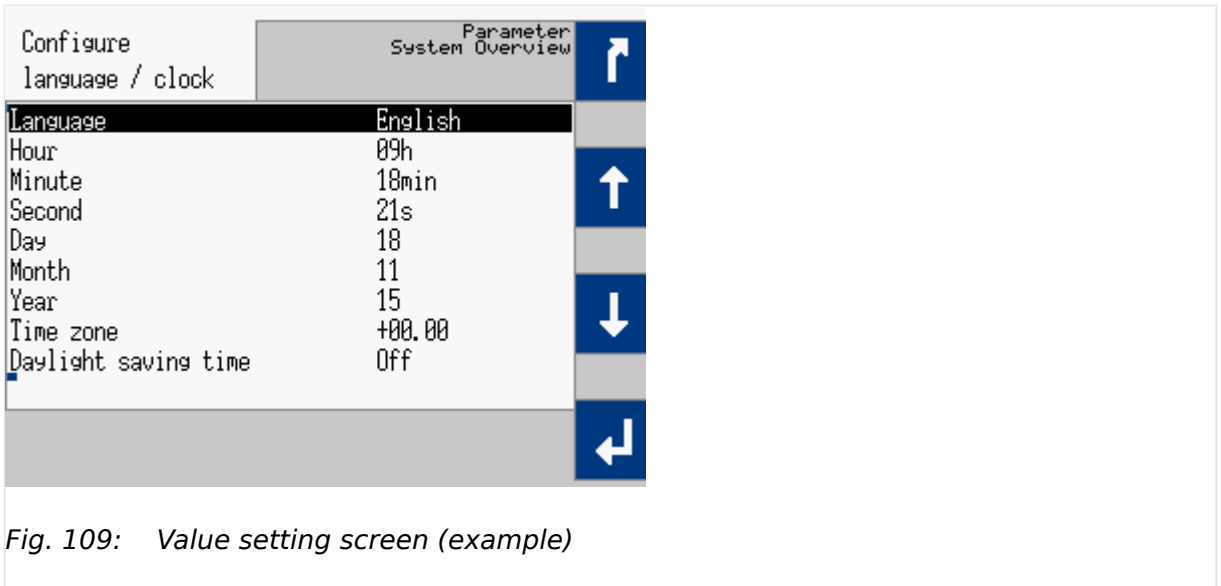

Fig. 109: Value setting screen (example)

At value setting screens the settings of the parameters can be changed.

Value setting screens samples:

Configure language / clock, Configure display, Password, Configure application ...



1. ▷ Use the following softkeys in a value setting screen to select, change and confirm a setting.

Softkey	Description
↑	Select previous value/entry.
↓	Select next value/entry.
+	Increase selected value.
-	Decrease selected value.
↩	Confirm and store changed value.

4.1.4.3 Status/Monitoring Screens

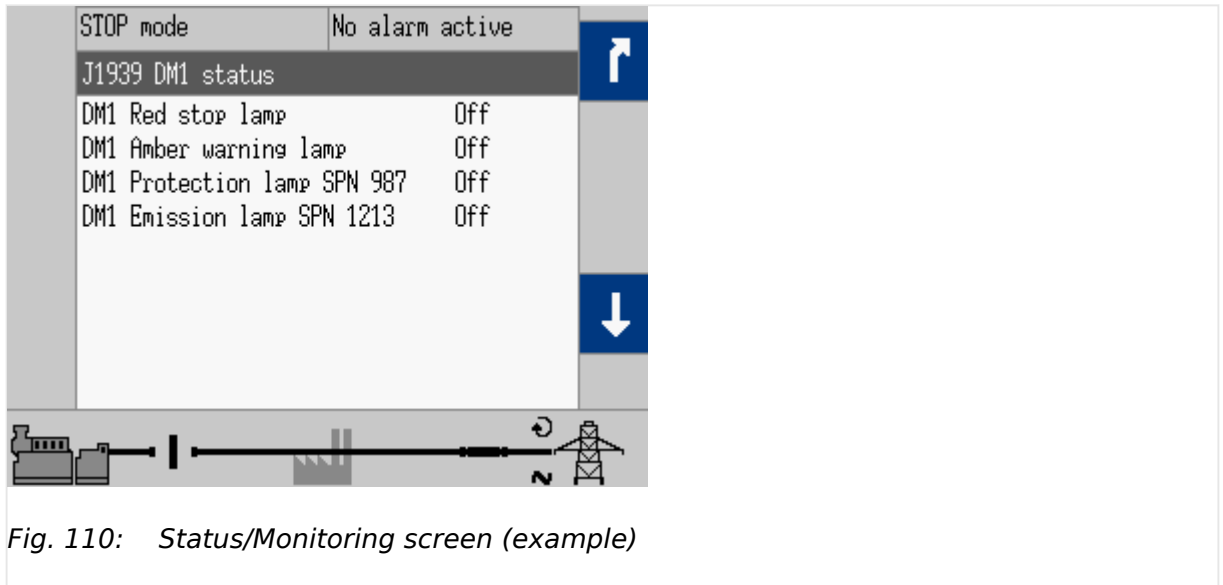

Fig. 110: Status/Monitoring screen (example)

Status/Monitoring screens display monitored values or set parameters.

Status/Monitoring screen	Notes
Generator	Which values are shown in the display and whether they are correct depends on the measurement type.
Busbar/System/LS-5	Which values are shown in the display and whether they are correct depends on the measurement type.
Mains	Which values are shown in the display and whether they are correct depends on the measurement type.
Analog inputs/outputs	The analog outputs are displayed as a percentage of the selected hardware range, i.e. 50% of a 0 to 20 mA output refer to 10 mA or alternatively as absolute values (depending on selected parameters).
Discrete inputs/outputs	The configured logic for the discrete input "N.O./N.C." will determine how the easYgen reacts to the state of the discrete input. If the respective DI is configured to N.O., the unit reacts on the energized state, if it is configured to N.C., it reacts on the de-energized state.
Counters and service	For additional information on setting/resetting counters refer to 4.10 Configure Counters .
Engine	—
Engine (J1939)	—
J1939 Analog values	—
J1939 Status	—
Actual date and time	—
Version	—
Load diagnostic	—

Table 31: Status/Monitoring screens samples

4.1.5 Specialized Menu Screens

4.1.5.1 HOME Screen Voltage Display

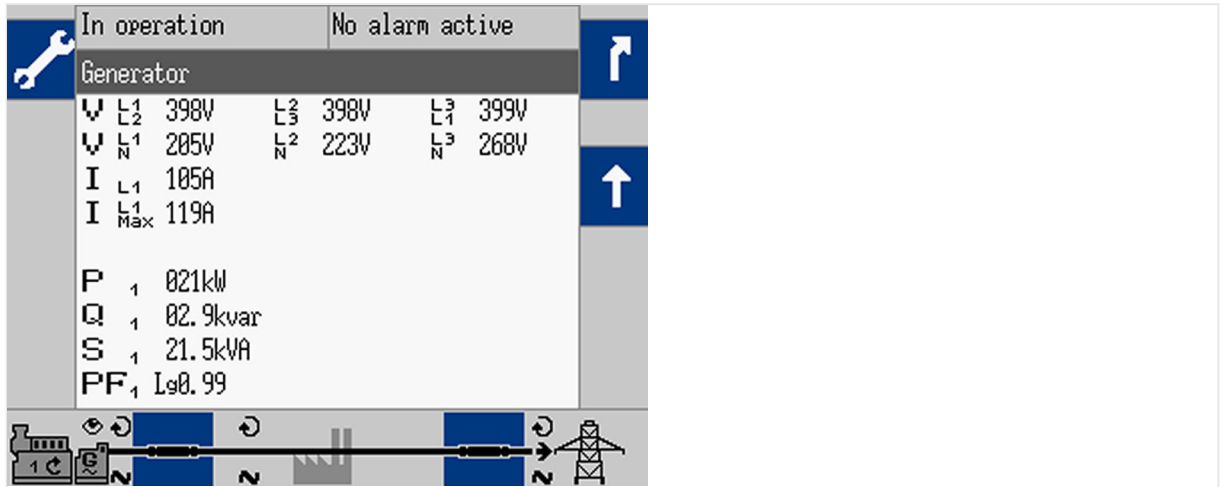



Fig. 111: Monitoring screen 2nd page (example)



If a softkey appears with a wrench symbol  it is possible to reset the peak hold value(s).

The softkey Δ/λ »Display mode« on the main screen "HOME" changes the type of voltage display.



The amount of information available from the system depends on how the measuring is configured in the control unit.

The following tables illustrate what values are available depending on the configured measurement type:

Press	The displayed voltages ...			Displayed at parameter setting			
	Symbol	Type	Measure	3Ph4W	3Ph3W	1Ph2W	1Ph3W
Δ/λ							
0x (6x)	V_{L1}^2	Delta	L1-L2	Yes	Yes	Yes ¹	—
1x	V_{L2}^3	Delta	L2-L3	Yes	Yes	—	—
2x	V_{L3}^1	Delta	L3-L1	Yes	Yes	—	Yes
3x	V_{N1}^1	Wye	L1-N	Yes	—	Yes ¹	Yes
4x	V_{N2}^2	Wye	L2-N	Yes	—	—	—
5x	V_{N3}^3	Wye	L3-N	Yes	—	—	Yes

Table 32: Measuring point - generator



¹ Depends on setting of parameter \hookrightarrow 1858.

Press	The displayed voltages ...			Displayed at parameter setting			
	Symbol	Type	Measure	3Ph4W	3Ph3W	1Ph2W	1Ph3W
0x (6x)	$V_{\Delta 1}$	Delta	L1-L2	Yes	Yes	Yes ¹	—
1x	$V_{\Delta 2}$	Delta	L2-L3	Yes	Yes	—	—
2x	$V_{\Delta 3}$	Delta	L3-L1	Yes	Yes	—	Yes
3x	V_{N1}	Wye	L1-N	Yes	—	Yes ¹	Yes
4x	V_{N2}	Wye	L2-N	Yes	—	—	—
5x	V_{N3}	Wye	L3-N	Yes	—	—	Yes

Table 33: Measuring point - mains



¹ Depends on setting of parameter \hookrightarrow 1858.

4.1.5.2 Alarm List

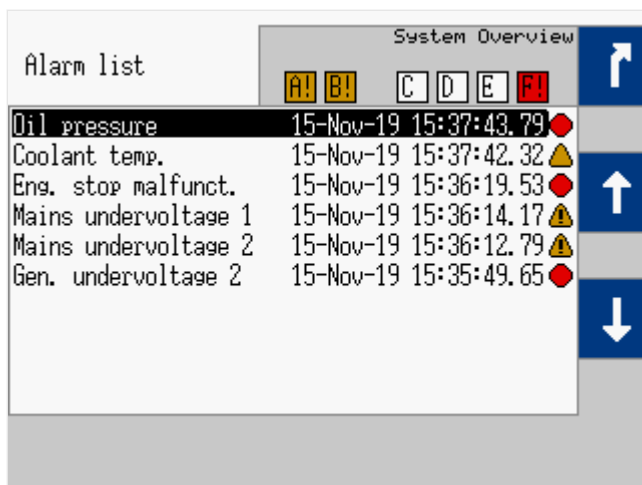









Fig. 112: Alarm List screen

All alarm messages, which have not been acknowledged and cleared, are displayed. Each alarm is displayed with the alarm message and the date and time of the alarm occurred in the format `yy-mon-dd hh:mm:ss.ss`.



Self-acknowledging alarm messages get a new timestamp when initializing the unit (switching on).

 Due to the time stamp, some long **J1939 texts** can only be displayed incompletely for space reasons.

Symbol/Softkey	Description
	Indicates that corresponding alarm condition (Class A/Class B) is still present.
	Indicates that corresponding alarm condition (Class A/Class B) is no longer present.
	Indicates that corresponding alarm condition (Class C - Class F) is still present.
	Indicates that corresponding alarm condition (Class C - Class F) is no longer present.
	Symbol with "!" indicates that an alarm of Class A - Class F is present. <ul style="list-style-type: none"> • Amber color = alarm Class A/Class B • Red color = alarm Class C/Class D/Class E/Class F
	Symbol without "!" indicates that an alarm of Class A - Class F is not present.
	Acknowledge the selected alarm message (displayed inverted).

 Acknowledgment is only possible, if the alarm condition is no longer present. If the Alarm LED is still flashing (an alarm is present, which has not yet been acknowledged as 'Seen'), this softkey resets the horn and acknowledges the alarm as 'Seen'.

4.1.5.3 Event History

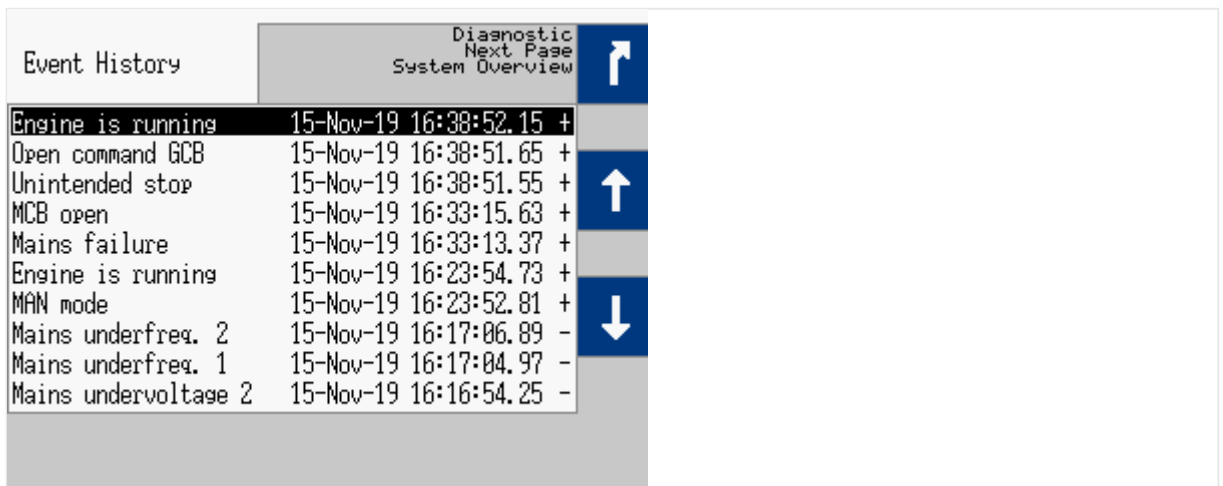



Fig. 113: Event History screen

This screen displays system events. A date/time stamp is added to each entry!

 Due to the time stamp, some long **J1939 texts** can only be displayed incompletely for space reasons.

Symbol/Softkey	Description
+	Indicates when a condition was activated
-	Indicates when a condition was de-activated

4.1.5.4 Sequencing

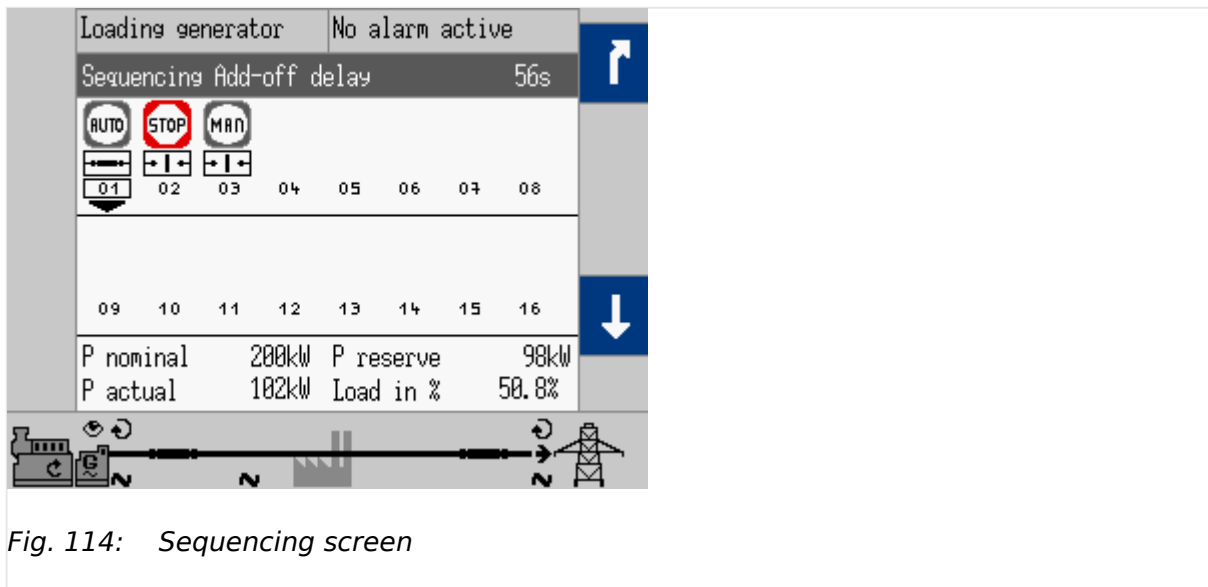

Fig. 114: Sequencing screen

The sequencing screen shows all gensets participating in load sharing. The operation mode of each genset as well as the state of its GCB is shown on this screen.

Symbol	Description
	AUTOMATIC Mode is active
	MANUAL Mode is active
	STOP Mode is active
	TEST Mode is active
	GCB of respective genset in sequence is closed.
	GCB of respective genset in sequence is open.
	Own easYgen device number
Sequence is running with respect to the settings e.g., the sequencing timing - see table below:	
	Generator is becoming "Add-on" to the (multiple) genset system.
	Generator is going "Add-off" from the (multiple) genset system.

The remaining time is displayed on the upper right side on the grey bar "Sequencing ...", see table below:

"..." text on the grey bar	Description	Parameter / ID
Sequencing Add-on delay ... s	Shows the remaining time until the own generator is add-on	Add-on delay:

"..." text on the grey bar	Description	Parameter / ID
		IOP 5764 MOP 5762
Sequencing Minimum run time ... s	Shows the remaining time the own generator is running at minimum	Minimum run time, 5759
Sequencing Add-off delay ...s	Shows the remaining time until the own generator is add-off	Add-off delay: IOP 5766 MOP 5773

 The bottom field displays the actual load sharing values. If this device is not participating in load sharing, "LD start stop Off" is displayed here.

4.1.5.5 States easYgen

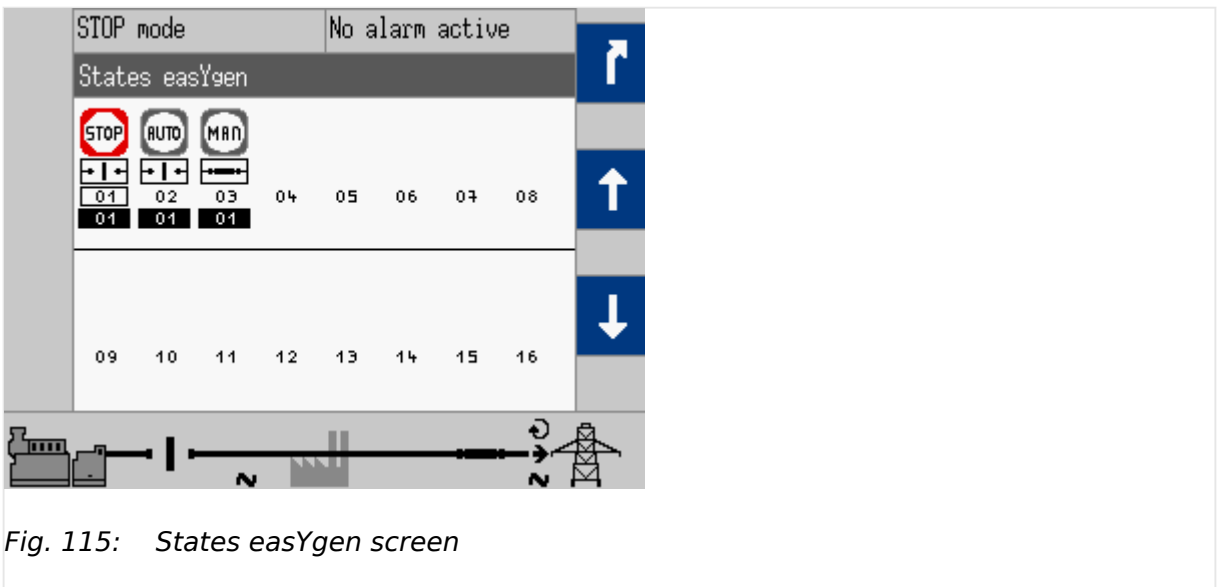







Fig. 115: States easYgen screen

The states of the easYgen devices are displayed. The operation mode of each genset as well as the state of its GCB is shown on this screen.

Symbol/Softkey	Description
	AUTOMATIC Mode is active
	MANUAL Mode is active
	STOP Mode is active
	TEST Mode is active
	GCB of respective genset in sequence is closed.
	GCB of respective genset in sequence is open.

Symbol/Softkey	Description
01	Own easYgen device number
02	Other easYgen device numbers
04	Segment number

4.1.5.6 States LSx

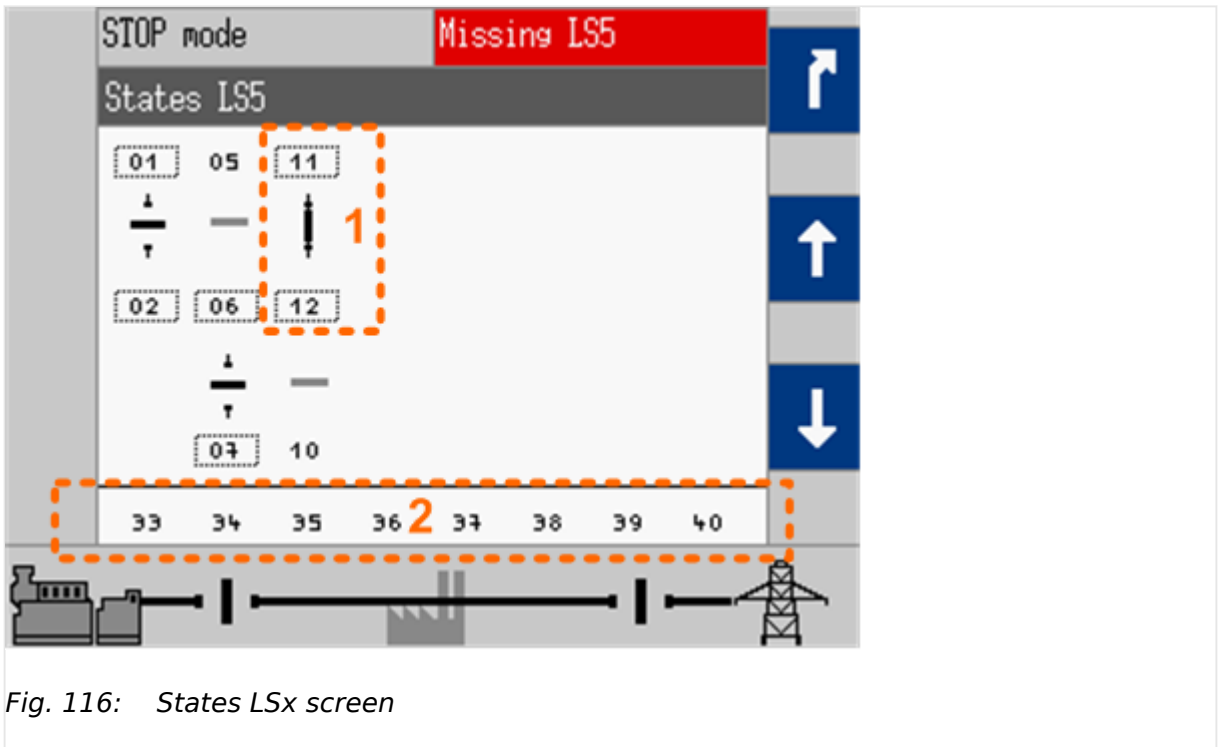

Fig. 116: States LSx screen

The states of the LSx devices are displayed.

Symbol/Softkey	Description
1: Segment numbers with switch in between	
	Segment numbers and breaker switch: opened/closed
	Segment numbers and isolation switch: opened/closed
06	Frame around number indicates voltage and frequency are in range
	Dotted frame around number indicates voltage or frequency are not in range but even not Dead busbar
06	NO frame around number indicates dead busbar
2: Device numbers (segments above and devices are aligned)	
33	LSx device numbers

4.1.5.7 Genset parameter alignment

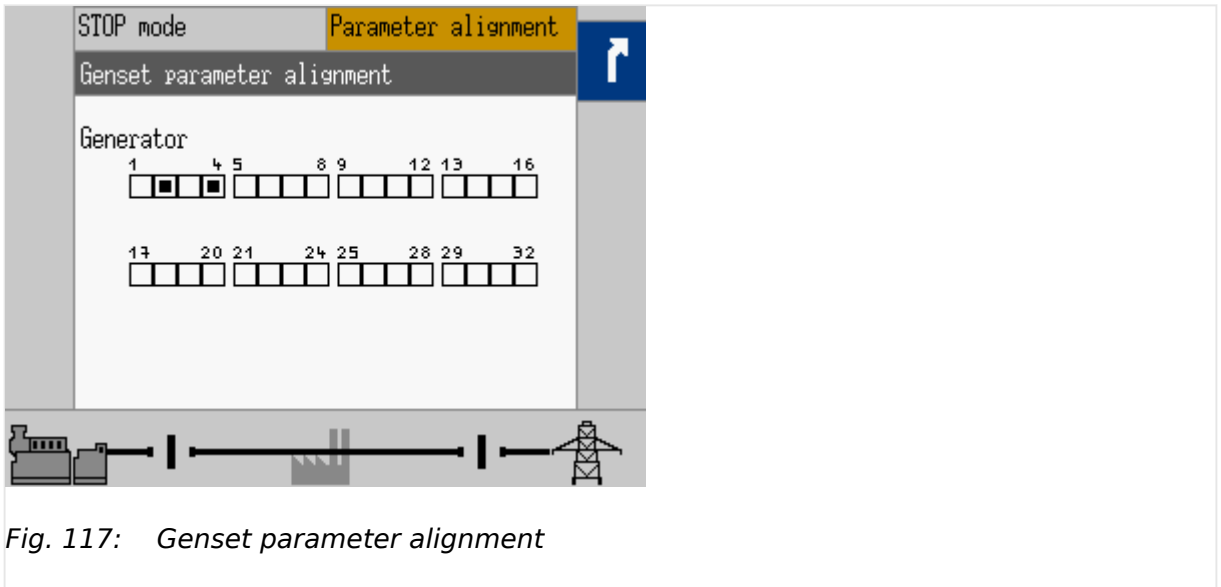

Fig. 117: Genset parameter alignment

This screen displays easYgen devices configured differently than the LDSS setting of your current device.

Symbol	Description
<input type="checkbox"/>	The easYgen uses the same configuration as your current device.
<input checked="" type="checkbox"/>	The easYgen uses a different configuration than your current device.

4.1.5.8 Diagnostic devices

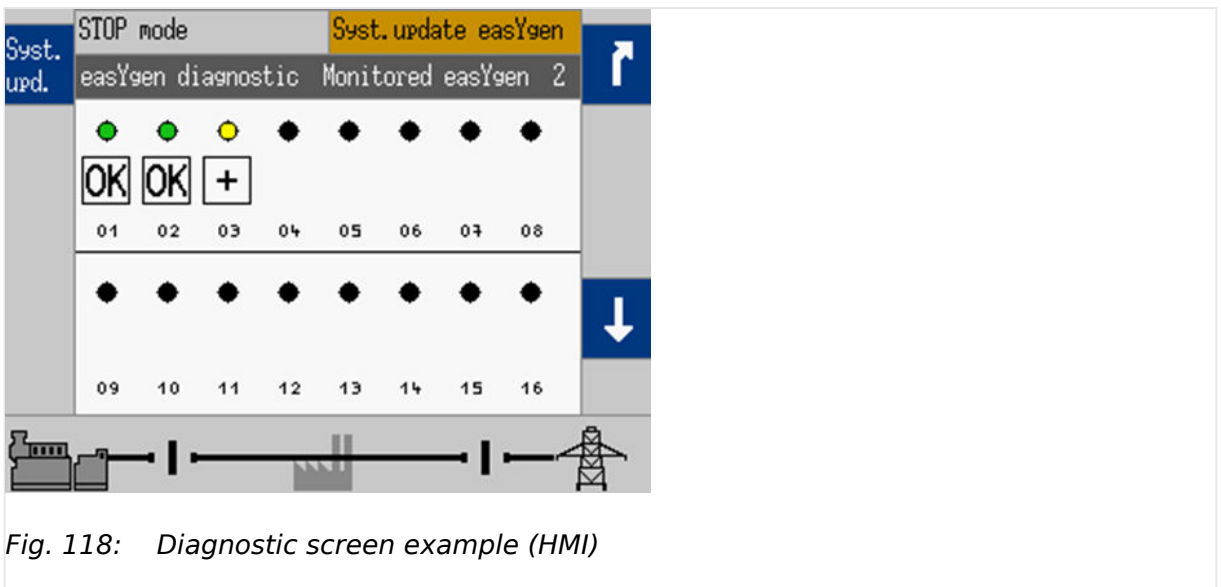

Fig. 118: Diagnostic screen example (HMI)

This screen displays the diagnostic status (the current communication state of the load share and system bus) of the accepted easYgen and/or LS-x devices. Refer to [6.2.2.2 Diagnostic Screens](#) for details.

4.1.5.9 Setpoints generator

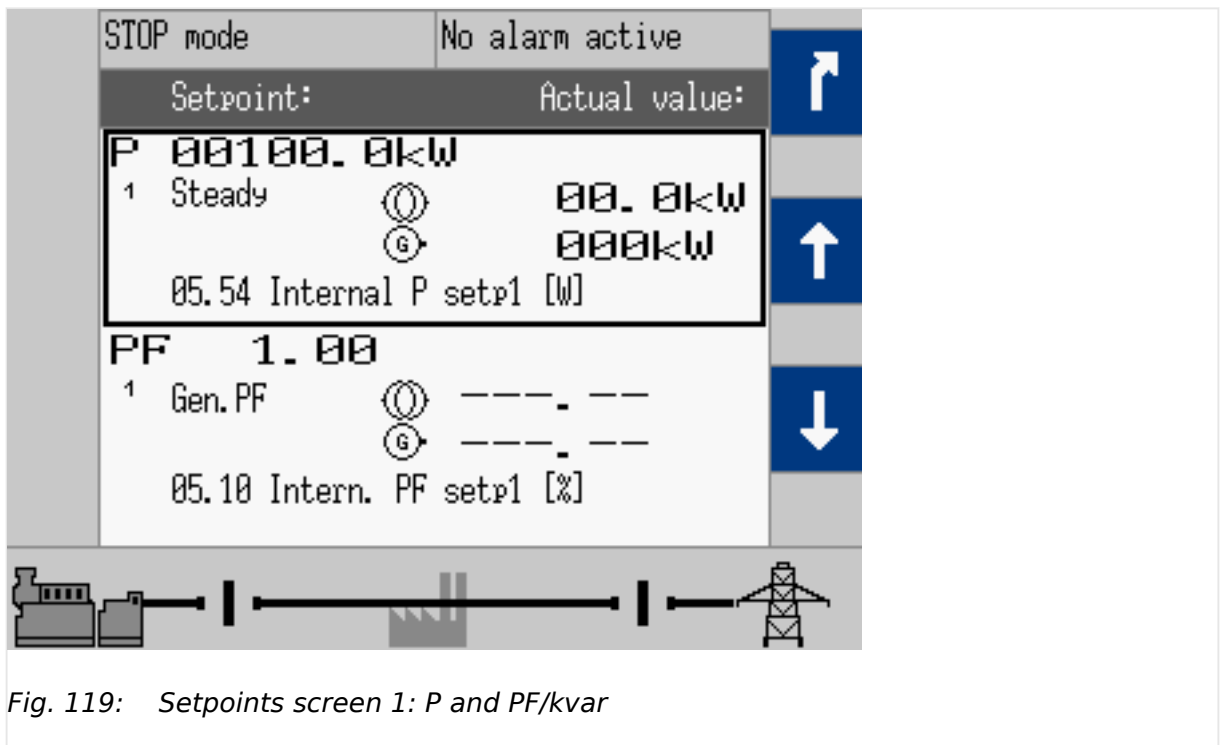

Fig. 119: Setpoints screen 1: P and PF/kvar

The setpoint is displayed on the left and the actual value is displayed on the right half of the screen.

The source, which is used for setpoint 1 or setpoint 2, is displayed with the respective AnalogManager function number.

The setpoints may only be adjusted if the respective controller is enabled. Frequency and voltage may be adjusted within the configured operating limits.

Active power may be adjusted between 0 and the configured load control setpoint maximum. The power factor may be adjusted between 0.71 leading and 0.71 lagging.



The source (e.g. "05.54 Internal P setp1 [kW]" like shown in the screenshots) can only be displayed if the corresponding AnalogManager (e.g. "AM ActPower SP1 [kW]") is set to type "Pass through". Otherwise the name of the selected AnalogManager e.g. "AM ActPower SP1 [kW]" will be displayed.

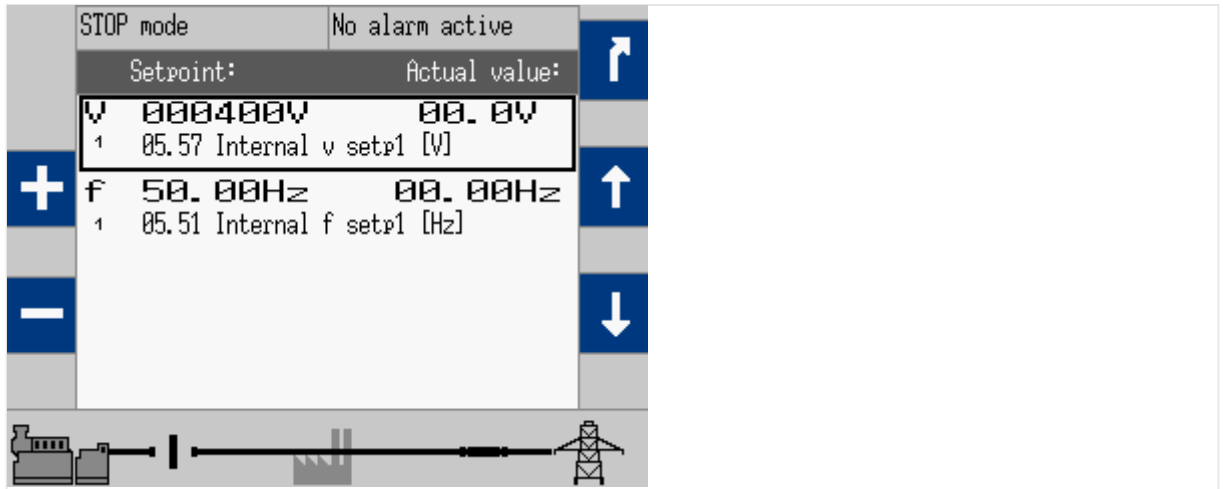

Fig. 120: Setpoints screen 2: V and f

Symbol/Softkey	Description
	Indicates the generator power (actual value).
	Indicates the mains power (actual value).
+	Raise the selected setpoint.
-	Lower the selected setpoint.

It is also possible to to adjust setpoints by the "Discrete Raise/Low" function (refer to [4.4.4.7 Discrete Raise/Low Function](#)). The adjustments via "HMI +/- buttons" or "Discrete Raise/Low" are only possible if the corresponding AnalogManager (e.g. "AM ActPower SP1 [kW]") is set to type "Pass through".

Possibilities for setpoint adjustment

The table below shows different possibilities for the voltage setpoint as an example how setpoints can be adjusted. (For the other setpoints this applies analogously with the corresponding parameters). In the example setpoint "5618 AM Voltage SP1 [V]" is active.

Depending on the assigned analog variable ("05.57 Internal v setp1 [V]" or "05.65 Discrete v +/- [V]"), there are several possibilities for setpoint adjustment in operation mode automatic.

(In manual mode the setpoint can always be adjusted via "Discrete raise/low" and via the "HMI +/- buttons" with configurable rate.)

Setpoint adjustment via	5618 AM Voltage SP1 [V] is configured to "AM Voltage SP1 [V]"		5618 AM Voltage SP1 [V] is configured to "05.65 Discrete v +/- [V]"	
	Discrete raise/low	HMI +/- buttons	Discrete raise/low	HMI +/- buttons
Operation mode "AUTO" or TEST	Not applicable	Fixed ramp rate	Configurable rate "5025 Discr. ramp voltage +/-"	Not applicable
Operation mode "MANUAL"	Configurable rate "5025 Discr. ramp voltage +/-"	Configurable rate "5025 Discr. ramp voltage +/-"	Configurable rate "5025 Discr. ramp voltage +/-"	Configurable rate "5025 Discr. ramp voltage +/-"

Manual mode and Auto mode do have separate setpoints. The Manual mode setpoints are temporary.

Setpoint for in AUTO mode	... in MANUAL mode	... in TEST mode
Load	5542	5529	5542
Reactive power	5646		5646
Power factor	5641	5623	5641
Voltage	5640	5605	5640
Frequency	5541	5509	5541



ToolKit's setpoint page "STATUS MENU | Setpoints" gives an overview.

4.1.5.10 Setpoints PID1 - PID3

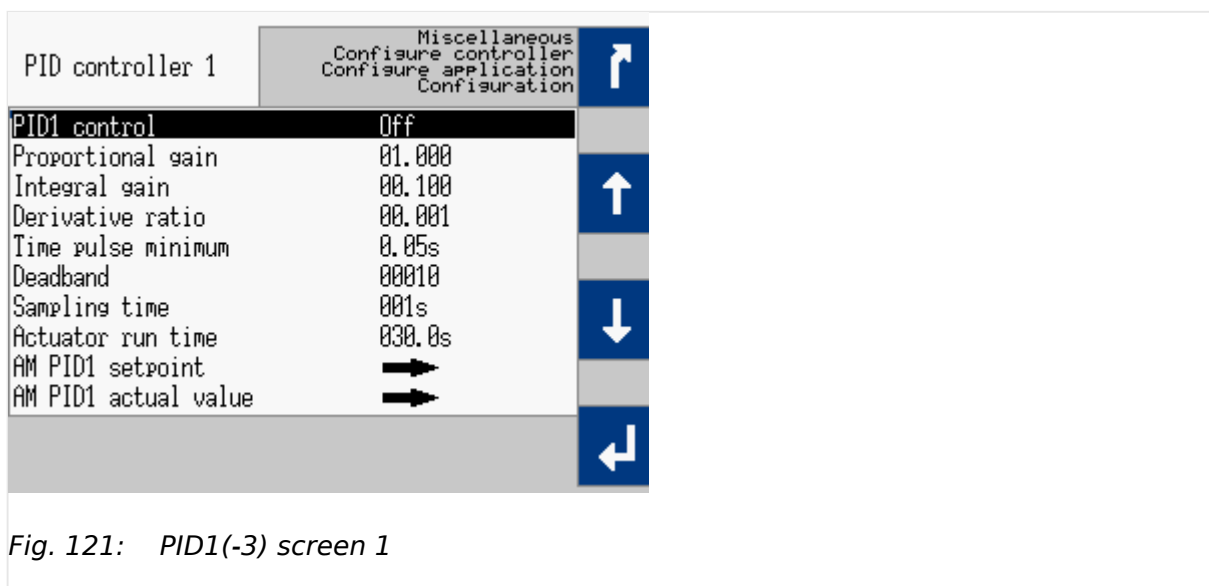

Menu path for configuration: [Parameter / Configuration / Configure application / Configure controller / Miscellaneous / PID1 control - PID3 control]

The PID screens enable direct access to PID control settings.

4 Configuration

4.1.5.10 Setpoints PID1 - PID3

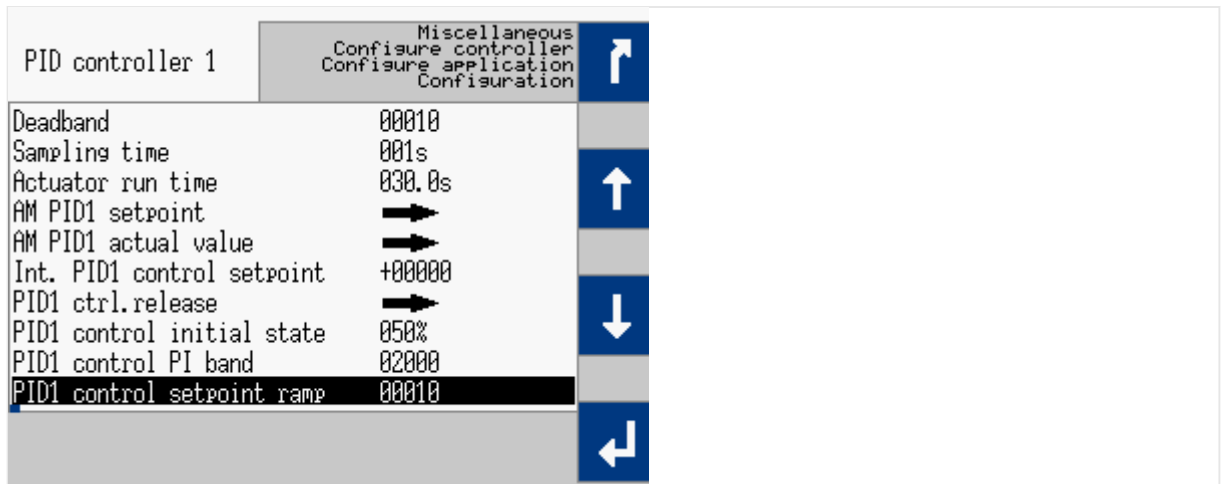

Fig. 122: PID1(-3) screen 2

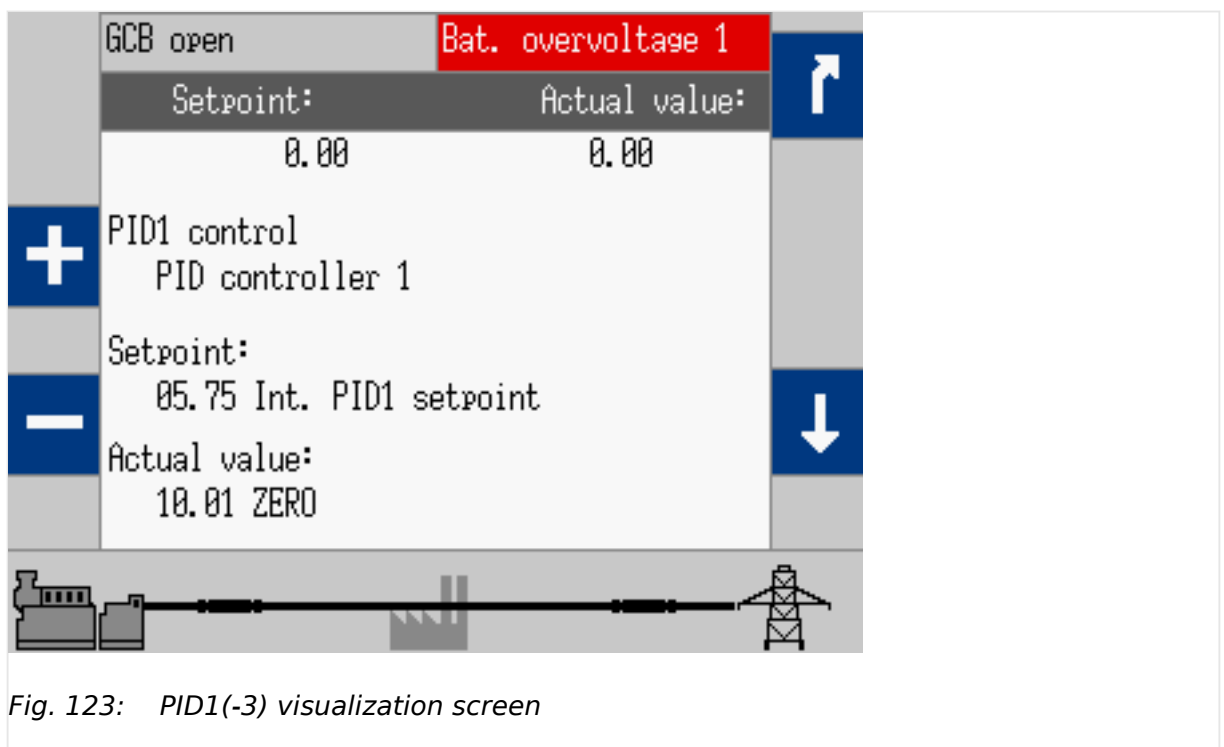

Fig. 123: PID1(-3) visualization screen

Menu path for visualization: [Next Page / Setpoints / Setpoints PID 1-3]

4.1.5.11 Synchroscope busbar/mains

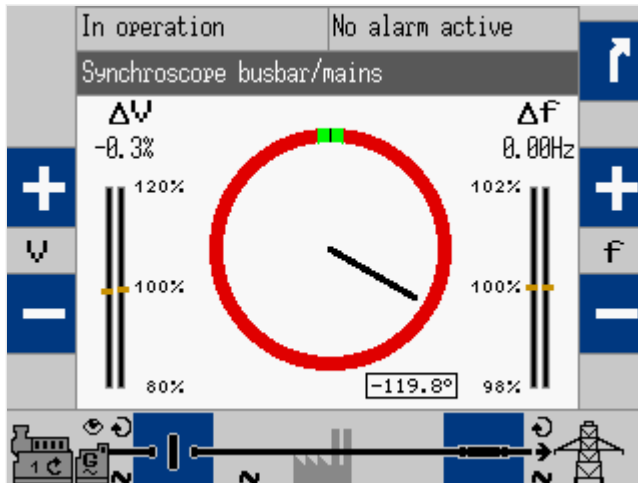

Fig. 124: Synchroscope screen (example)

The needle indicates the actual phase angle between busbar and generator or mains.



Please take care for compensation settings with parameters [8825](#) »Phase angle compensation GCB« and [8824](#) »Phase angle GCB«.

If phase angle compensation [8825](#) is active the compensated values are taken for synchroscope display (and synchronization)!

WARNING!



Ensure correct synchronization configuration to avoid generator destructive power!

The 12 o'clock position on the top means 0° and the 6 o'clock position on the bottom means 180°.

The actual phase angle is indicated on the bottom of the screen. The maximum positive and negative phase angles are indicated 'green'. The length of the green part changes according to the parameters.

The frequency and voltage differences are indicated on top of the bargraphs.

Symbol/Softkey	Description
+	Operating mode MANUAL: Raise voltage/frequency.
-	Operating mode MANUAL: Lower voltage/frequency.

4.1.5.12 LogicsManager Conditions

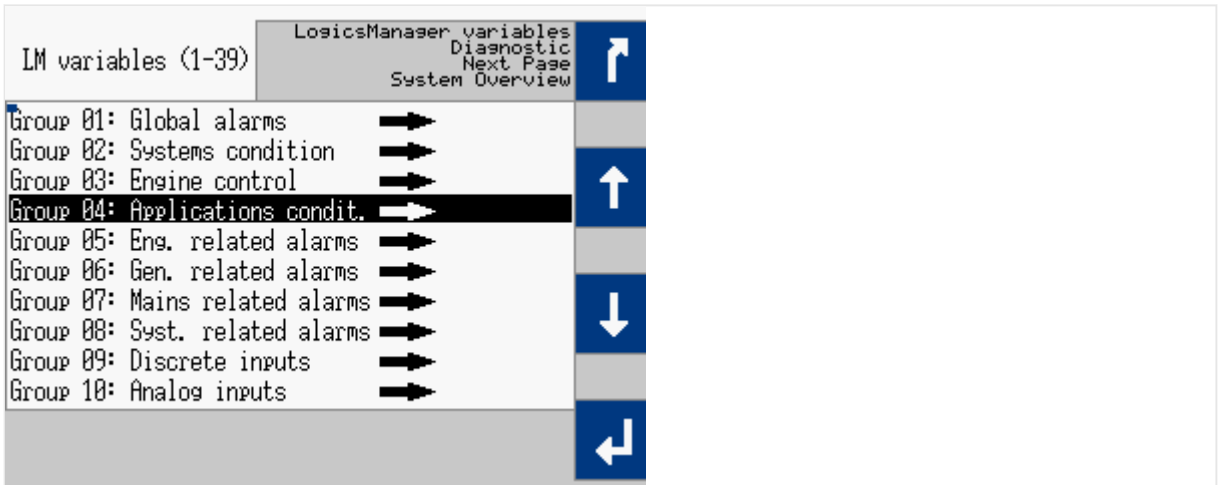

Fig. 125: LogicsManager conditions screen

This screen displays the conditions of all LogicsManager command variables, which are located in their respective groups.

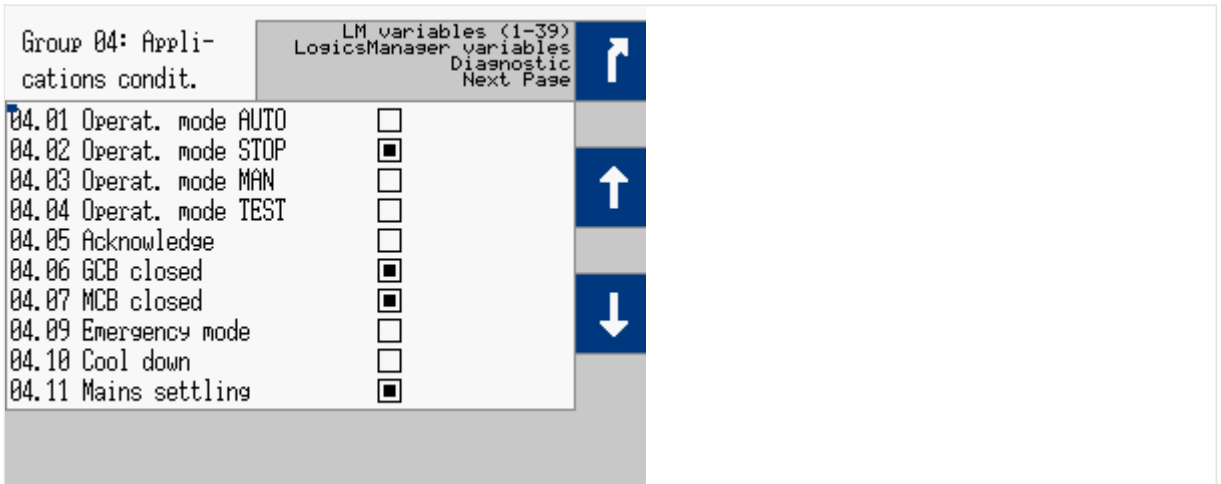

Fig. 126: Command variables screen (example)

Symbol	Description
	Select the highlighted command variable group and display the state of the command variables in this group.
<input checked="" type="checkbox"/>	Variable is TRUE.
<input type="checkbox"/>	Variable is FALSE.

4.1.5.13 LogicsManager

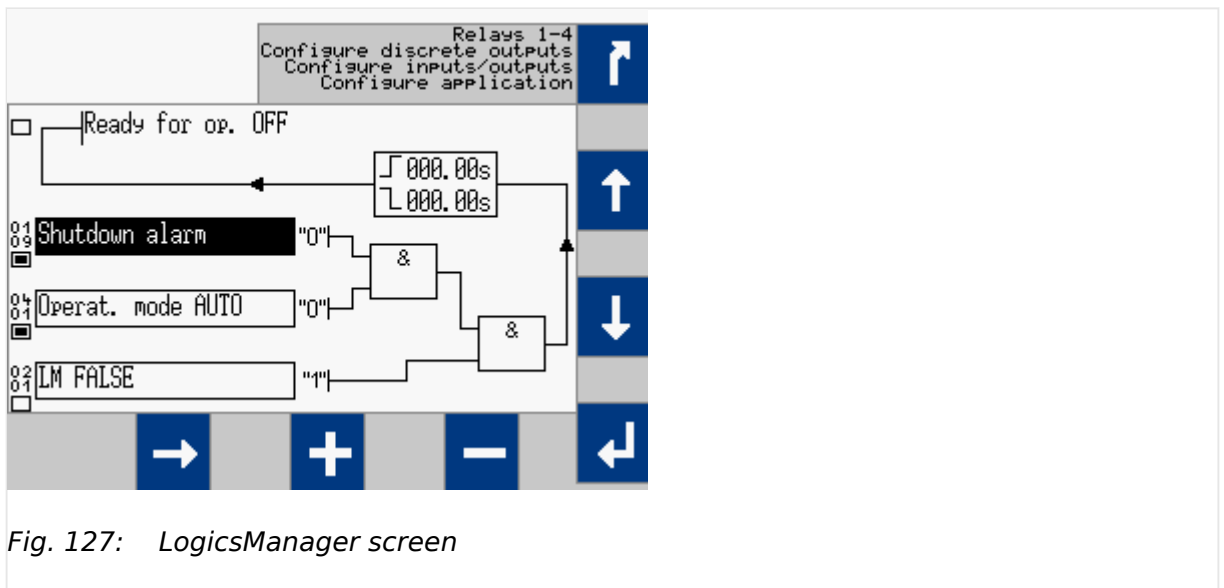

Fig. 127: LogicsManager screen

Some parameters of the easYgen are configured via the LogicsManager.

- ⚙
- 1. ▷

Configure a logical operation using various command variables, signs, logical operators, and delay times to achieve the desired logical output.

Symbol/Softkey	Description
┌	Delay before output becomes TRUE.
└	Delay before output becomes FALSE.
▣	State of the command variable is TRUE.
□	State of the command variable is FALSE.
→	Command variable selection field: Change the command variable group. Time delay configuration field: Change the cursor position.



Help screen

Help screen (displays logical operators) can be found at [Parameter / Configuration / Configure L / A Manager / General settings LM and AM / Help for ASA/IEC symbols]

4.1.5.14 Mains decoupling threshold

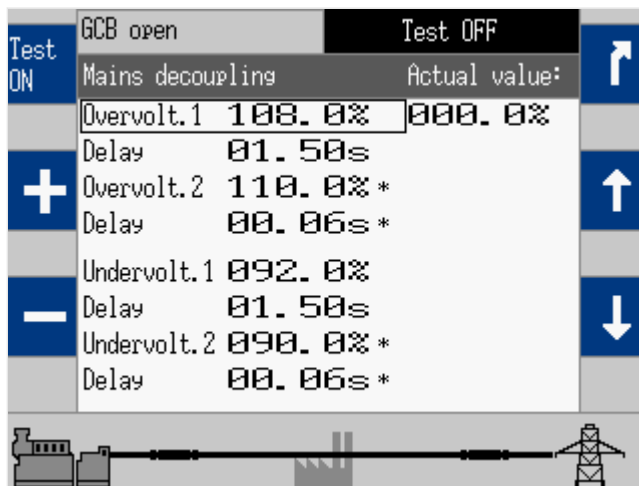

Fig. 128: Mains decoupling screen 1

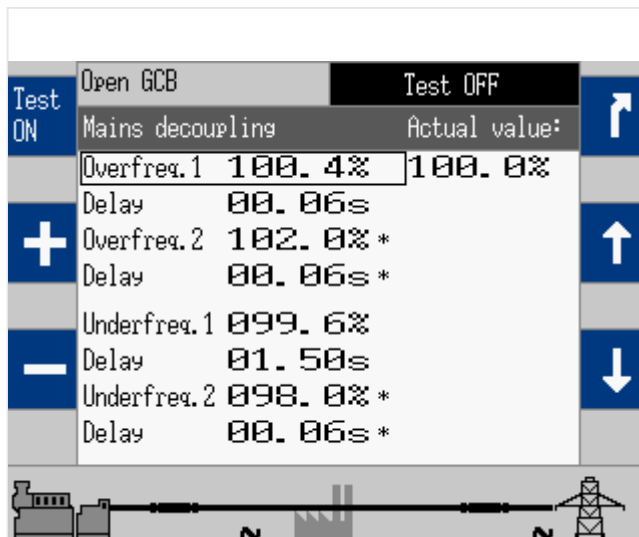

Fig. 129: Mains decoupling screen 2

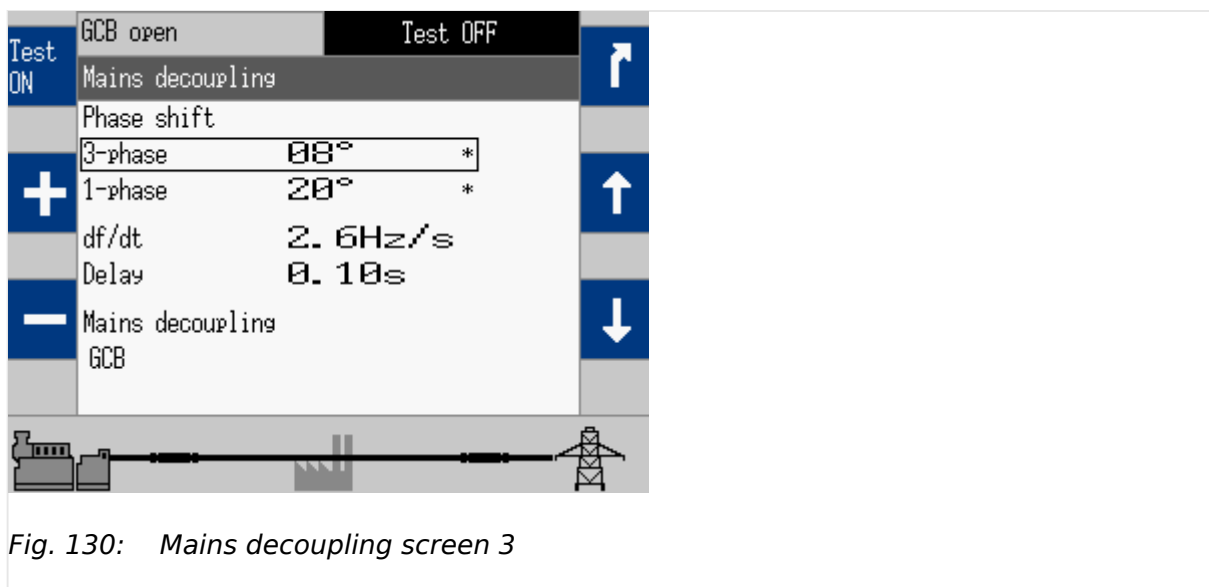

Fig. 130: Mains decoupling screen 3

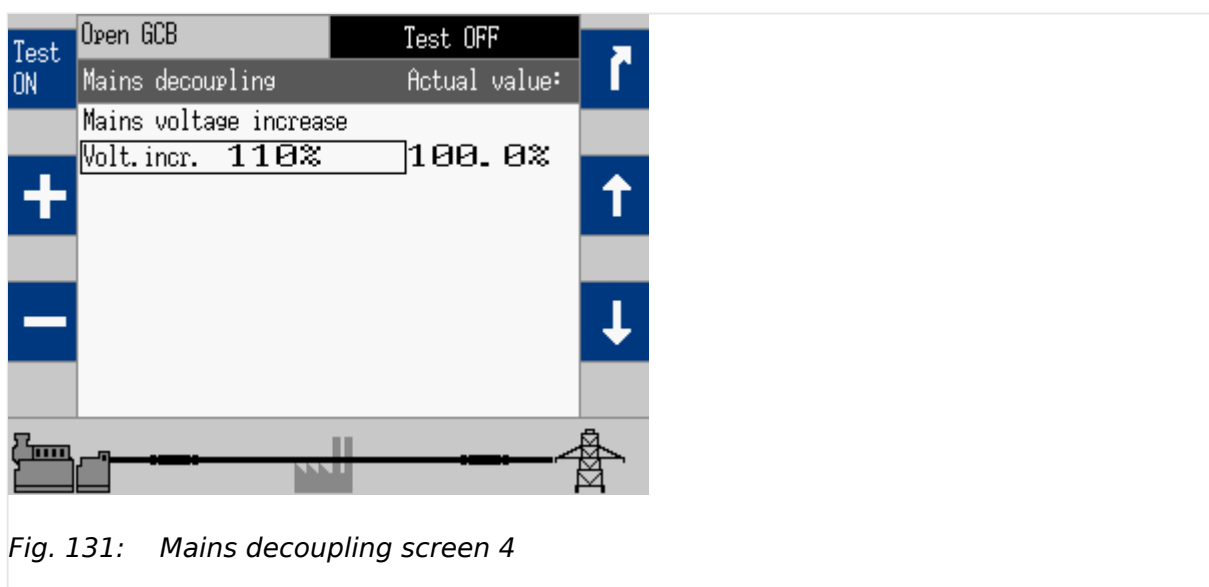

Fig. 131: Mains decoupling screen 4

4.1.5.15 Test mains decoupling (VDE AR-N 4105)

Symbol/Softkey	Description
	Starts a special TEST mode which allows mains decoupling test independent from breaker status (even if not mains parallel; GCB open, no rotation of prime mover/generator).
	Stops the TEST mode so mains decoupling is possible if system is mains parallel only. Notes: TEST mode is deactivated not only by this button but too: <ul style="list-style-type: none"> • ... if firing speed is reached or • ... automatically after 60 minutes
*	Indicates parameters that are part of the mains decoupling configuration.

4 Configuration

4.1.5.15 Test mains decoupling (VDE AR-N 4105)

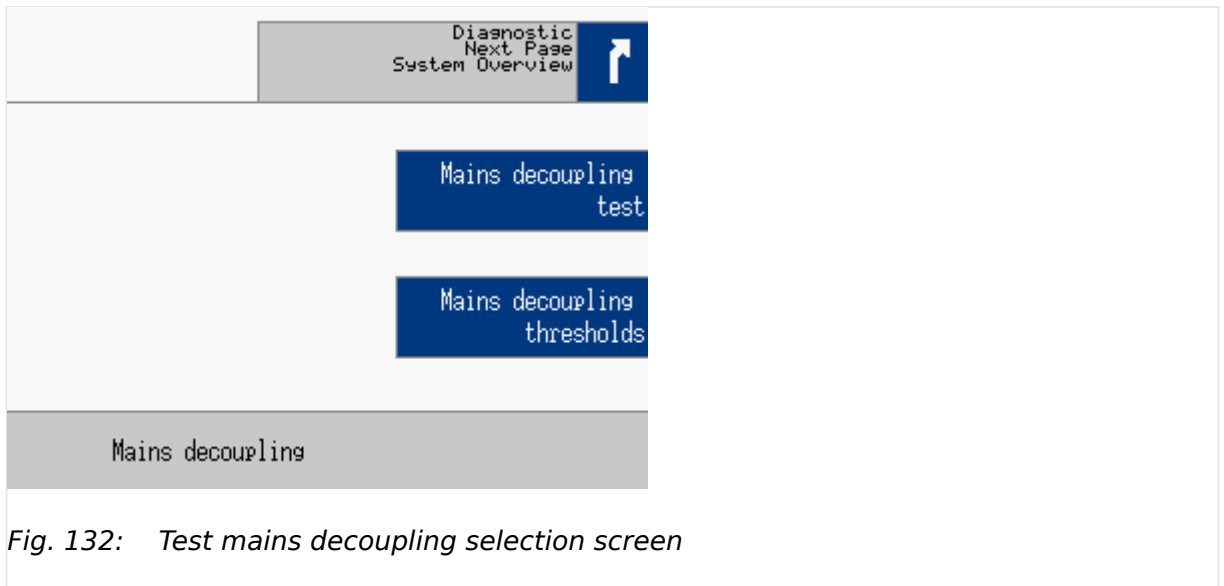

Fig. 132: Test mains decoupling selection screen

VDE AR-N 4105 is asking for a test button.



Restricted Access

The function Mains Decoupling Test is available on Code level CL3. Code levels CL0 to CL2 are intentionally not supported. Refer to [4.3.4 Enter Password](#) for details.

Mains decoupling test is running after the warning is accepted.

The Mains decoupling test opens the selected breaker for mains decoupling (parameter [3110](#)).

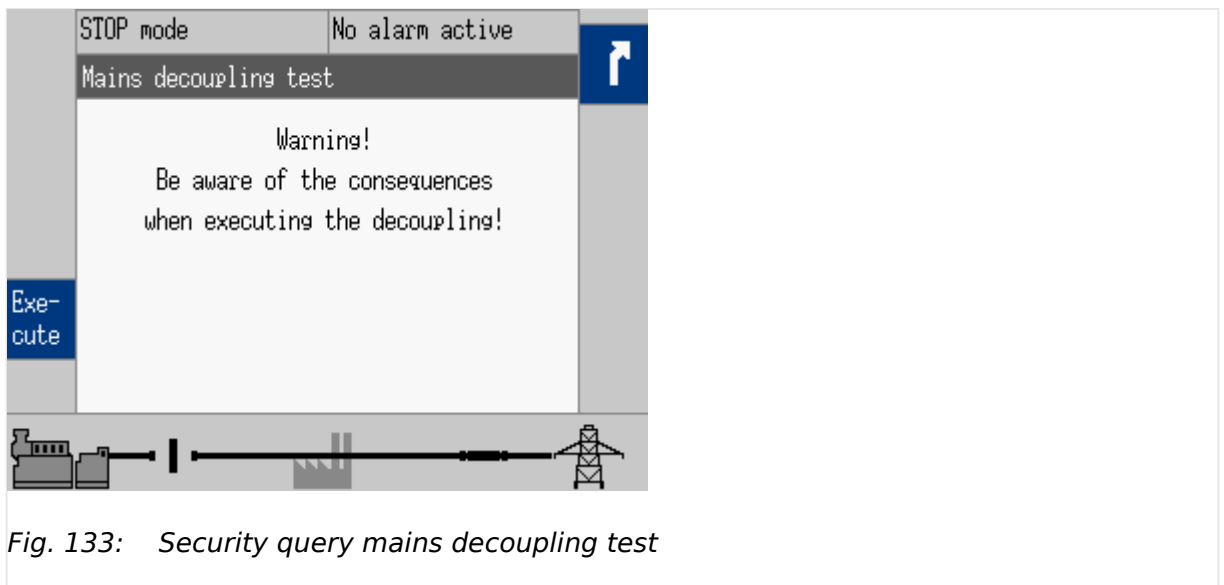

Fig. 133: Security query mains decoupling test

CAUTION!



This function is independent from the breaker status and is active for 1 sec.

No thresholds are considered.

As long as the decoupling function is executed the »Execute« button and the warning text are faded out.

4.1.5.16 CAN 1 state

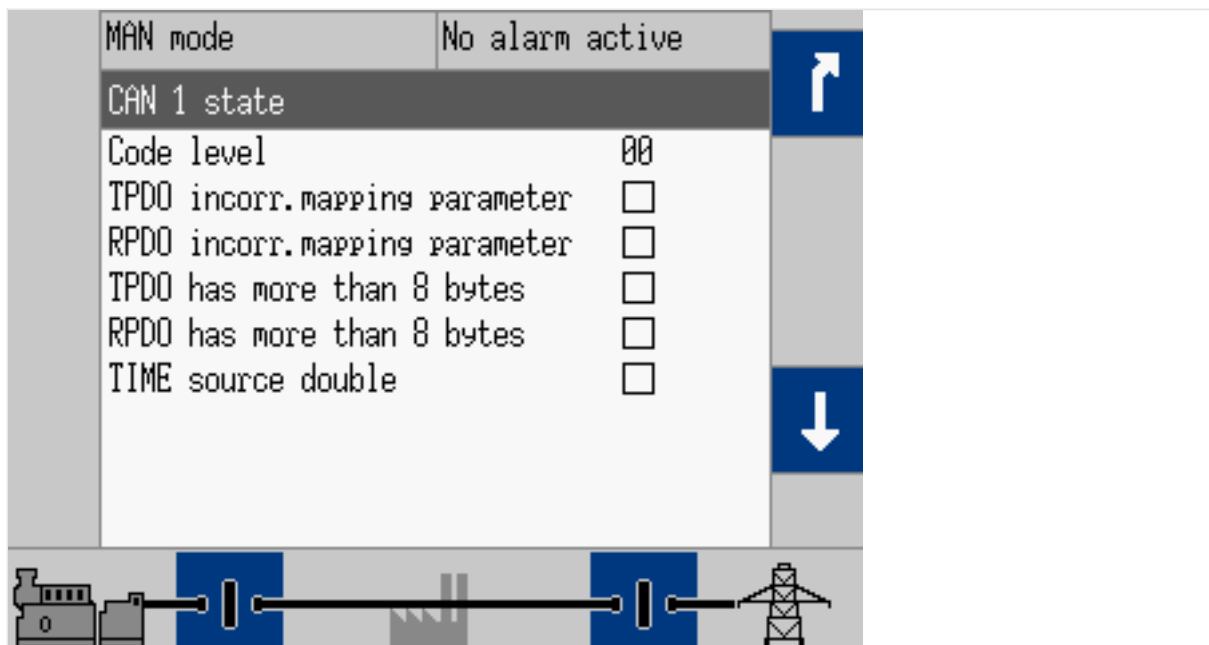

Fig. 134: CAN 1 state screen (example)

Symbol	Description
<input checked="" type="checkbox"/>	State is TRUE
<input type="checkbox"/>	State is false

Table 34: Graphic assignments

Section		Description
Code level	00	Current code level of CAN1 connection
TPDO has incorrect mapping parameters	<input checked="" type="checkbox"/>	State is TRUE/false
RPDO has incorrect mapping parameters	/	
TPDO has more than 8 bytes	<input type="checkbox"/>	
RPDO has more than 8 bytes		
TIME source double		

Table 35: Bit assignments

4 Configuration

4.1.5.17 CAN interface 2 state

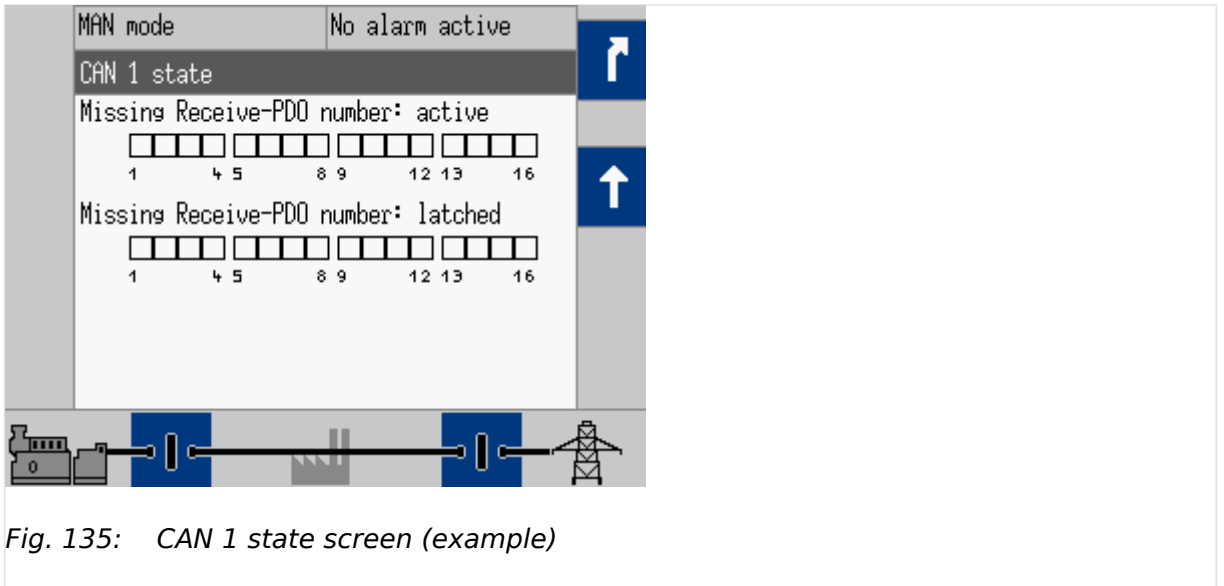

Fig. 135: CAN 1 state screen (example)

Symbol	State	Description
<input checked="" type="checkbox"/>	State is TRUE	PDO is missing
<input type="checkbox"/>	State is false	PDO is NOT missing

Table 36: Graphic assignments

Section		Assignment
Missing Receive-PDO number: active	{x}	RPDO {x} is not received at the moment
Missing Receive-PDO number: latched	{x}	RPDO {x} has not been received
		Notes CAN 1 monitoring 3150 must be enabled

4.1.5.17 CAN interface 2 state

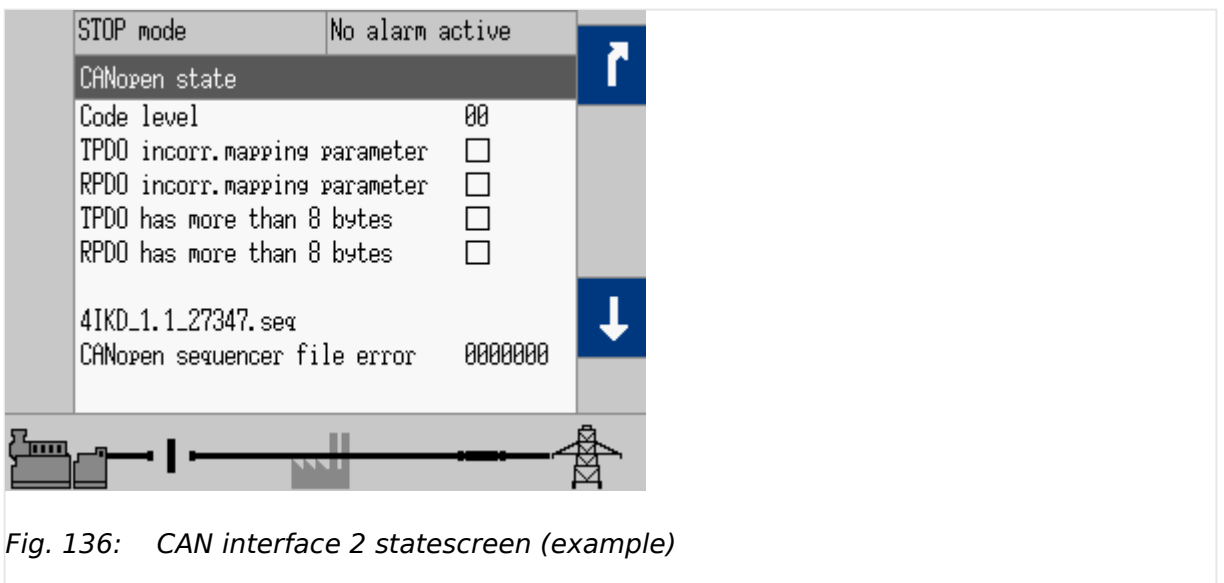

Fig. 136: CAN interface 2 statescreen (example)

Symbol	Description
▣	State is TRUE
□	State is false

Table 37: Graphic assignments

Section		Description
Code level	00	Current code level of CAN2 connection (don't care for the current applications)
TPDO has incorrect mapping parameters	▣	State is TRUE/FALSE (The mapping is done automatically by the parameter ↩> 15320 "Select external terminals")
RPDO has incorrect mapping parameters	/	
TPDO has more than 8 bytes	□	
RPDO has more than 8 bytes		
Text "4IKD_1.1_27347.seq"		This example indicates the name of the current selected file for the external terminals inclusive version. If this line shows "---", the file is missing on the device. Notes For the different selections of external terminals different files are stored in the device.
Text "CANopen sequencer file error"	0000000	If the value indicated here is not equal "0000000" there is something wrong with the file indicated above.

Table 38: (Bit) assignments

The next screen indicates missing Node-IDs of the external terminals.

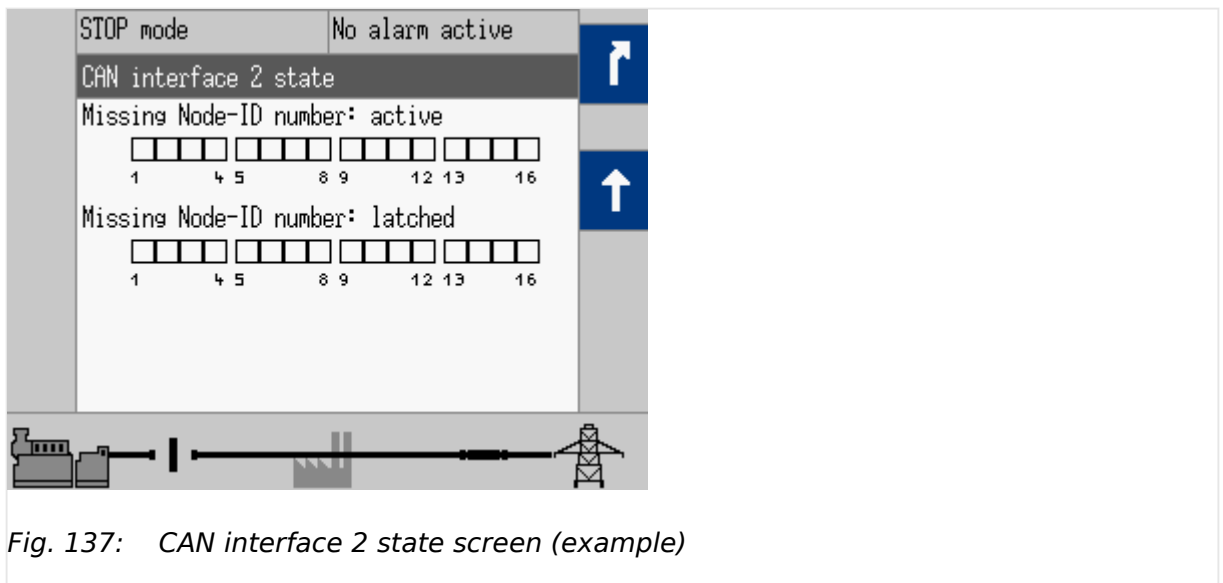

Fig. 137: CAN interface 2 state screen (example)

Symbol	State	Description
▣	State is TRUE	Node-ID is missing

Symbol	State	Description
□	State is false	Node-ID is NOT missing

Table 39: Graphic assignments

Section		Assignment
Missing Node-ID number: active	{x}	Node {x} is not received at the moment
Missing Node-ID number: latched	{x}	Node {x} has not been received
		Notes CAN 2 monitoring 3150 must be enabled

J1939 state

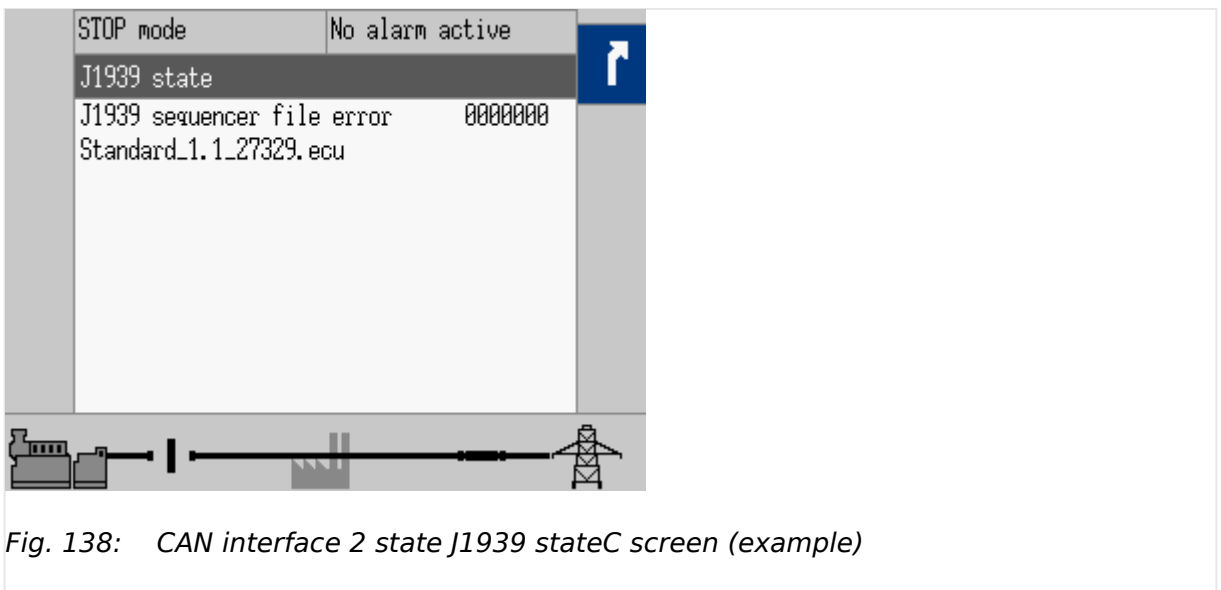

Fig. 138: CAN interface 2 state J1939 stateC screen (example)

Section		Description
Text "J1939 state"		Screen title / Interface type
Text "J1939 sequencer file error"	00000000	If the value indicated here is not equal "00000000" there is something wrong with the file indicated below.
Text e.g. "Standard_1.1_27347.ecu"		This example indicates the name of the current selected file for ECU inclusive version. If this line shows "---", the file is missing.
		Notes For the different selections of "Device type" different files are stored in the device.

Table 40: Assignments

4.1.5.18 CAN 3 state

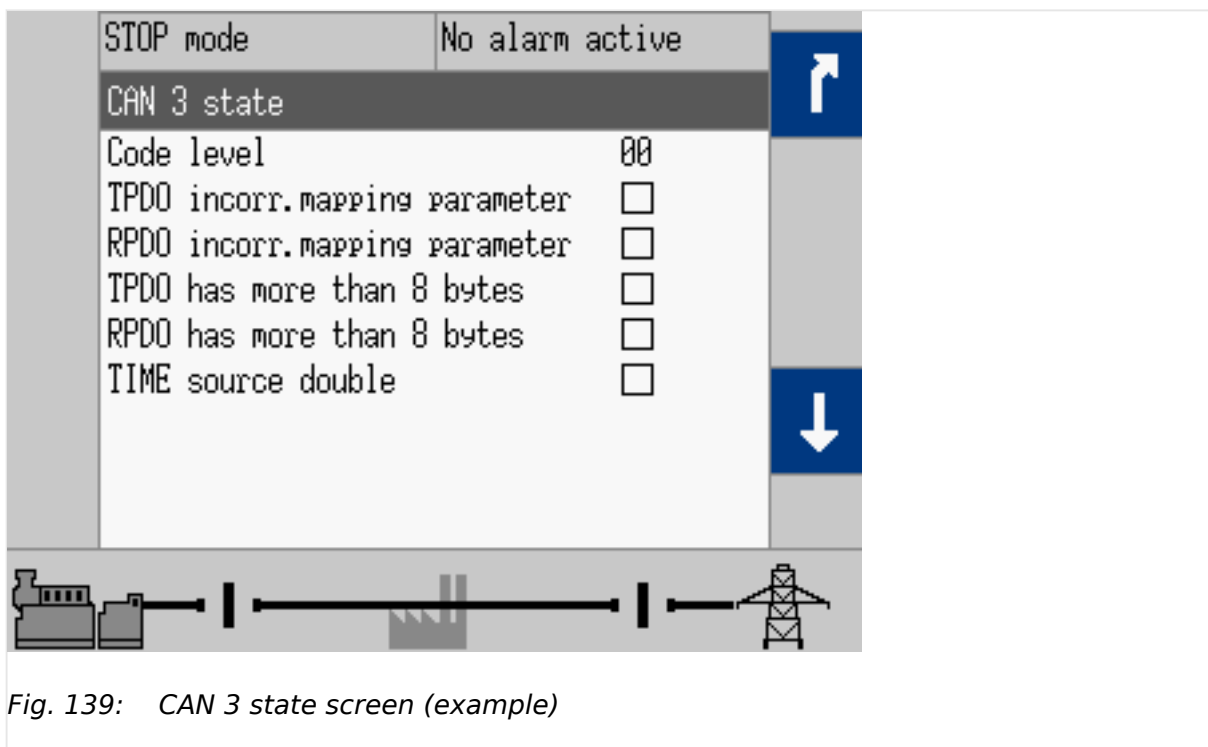

Fig. 139: CAN 3 state screen (example)

Symbol	Description
<input checked="" type="checkbox"/>	State is TRUE
<input type="checkbox"/>	State is false

Table 41: Graphic assignments

Section		Description
Code level	00	Current code level of CAN3 connection
TPDO has incorrect mapping parameters	<input checked="" type="checkbox"/>	State is TRUE/false
RPDO has incorrect mapping parameters	/	
TPDO has more than 8 bytes	<input type="checkbox"/>	
RPDO has more than 8 bytes		
TIME source double		

Table 42: Bit assignments

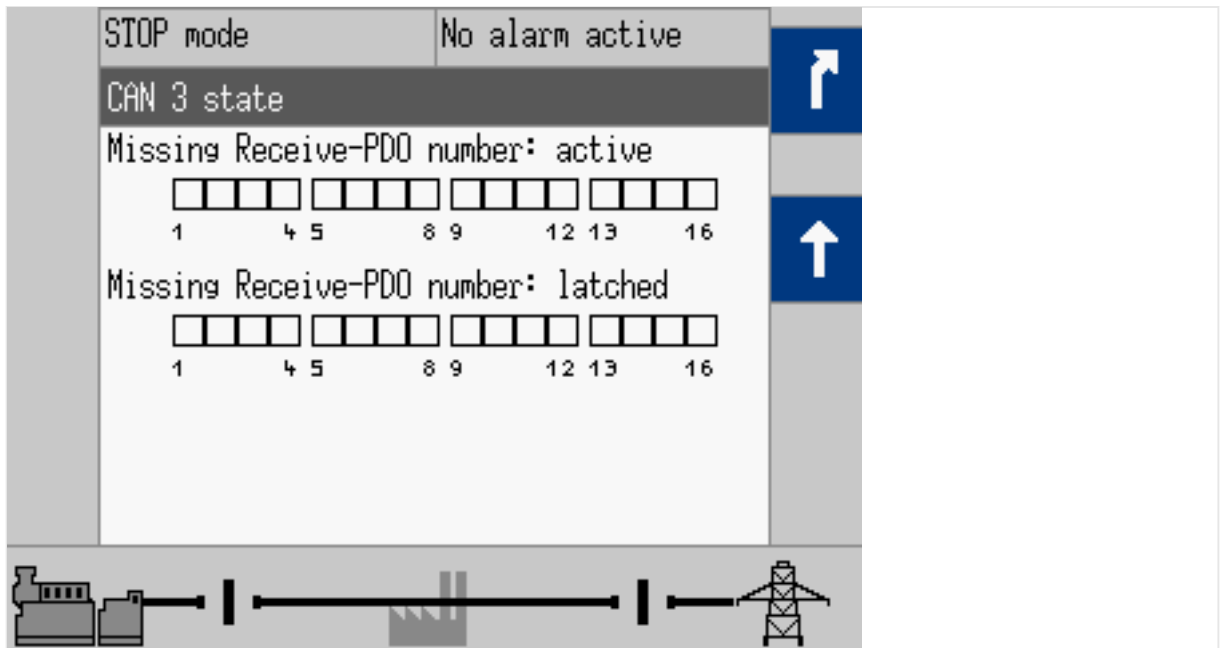

Fig. 140: CAN 3 state screen (example)

Symbol	State	Description
<input checked="" type="checkbox"/>	State is TRUE	PDO is missing
<input type="checkbox"/>	State is false	PDO is NOT missing

Table 43: Graphic assignments

Section		Assignment
Missing Receive-PDO number: active	{x}	RPDO {x} is not received at the moment
Missing Receive-PDO number: latched	{x}	RPDO {x} has not been received
		Notes CAN 3 monitoring 3165 must be enabled

4.1.5.19 Ethernet Network

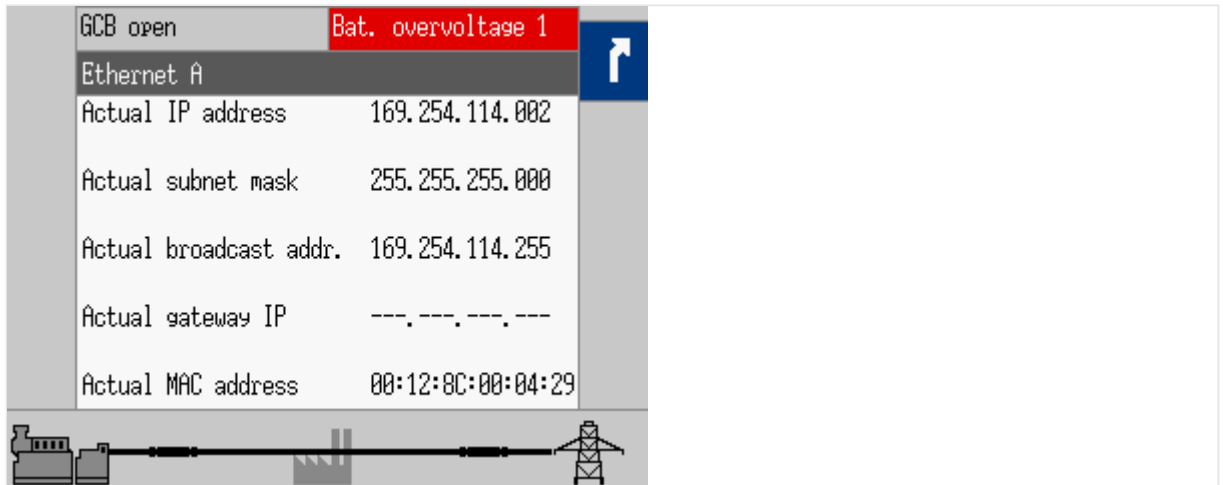

Fig. 141: Ethernet A state screen (example)

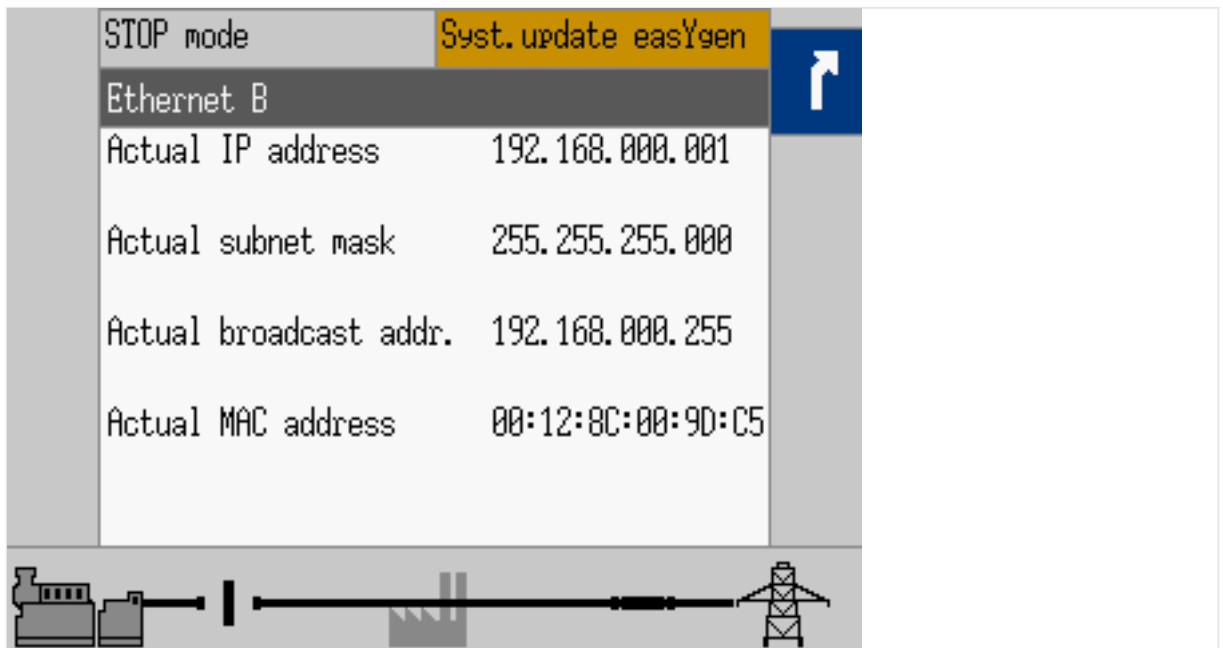

Fig. 142: Ethernet B state screen (example)

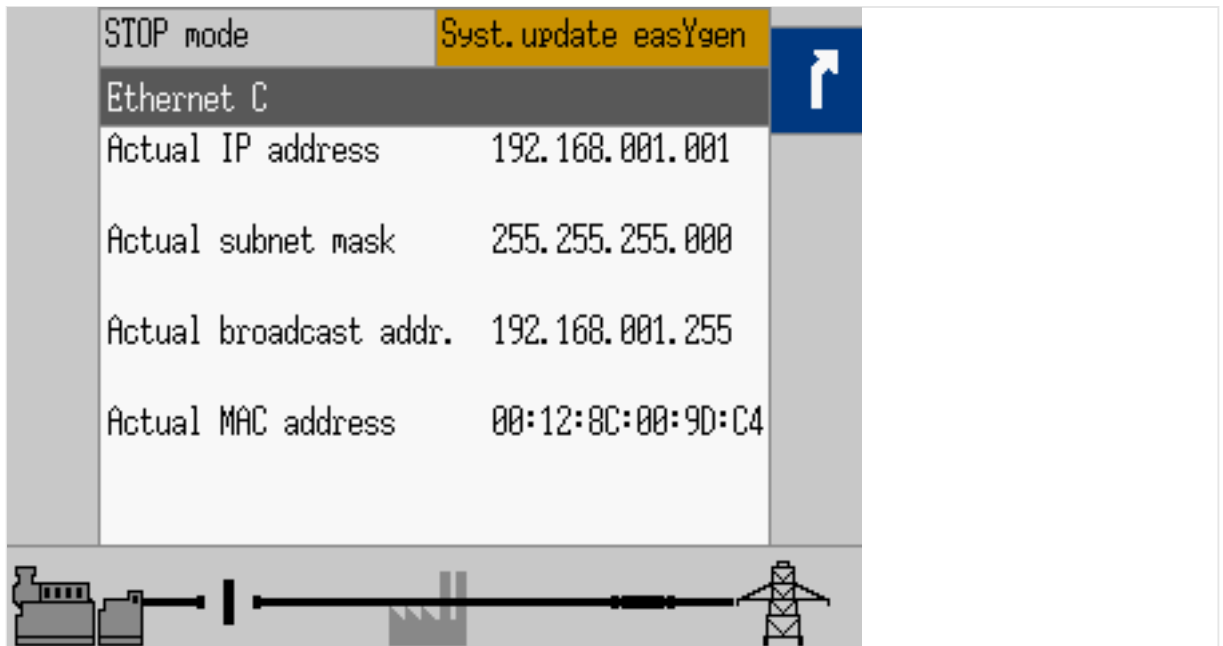

Fig. 143: Ethernet C state screen (example)

Current Ethernet state is displayed. Setting can be found under [Next Page / Diagnostic / Interfaces / Ethernet].

In this menu select:

- »Ethernet A«
- »Ethernet B«
- »Ethernet C«
- »SNTP«
- »Servlink«
- »Modbus TCP/IP«



See chapter [7.2 Ethernet Interfaces](#) for configuration.

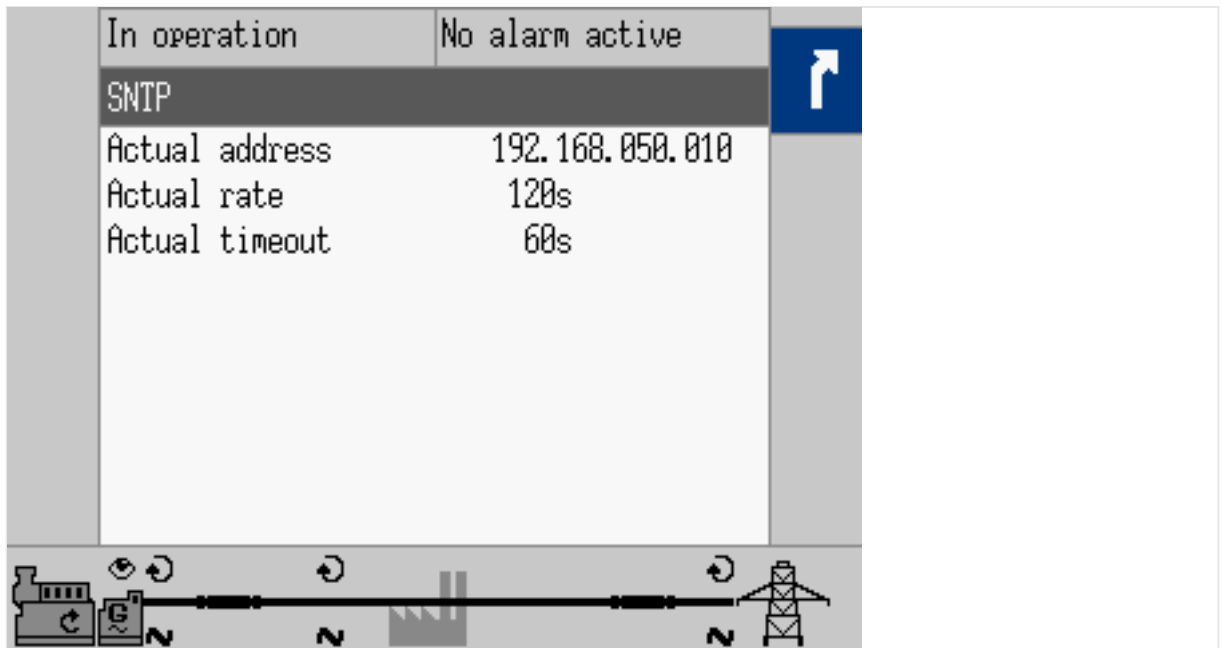

Fig. 144: Ethernet SNTP (example)

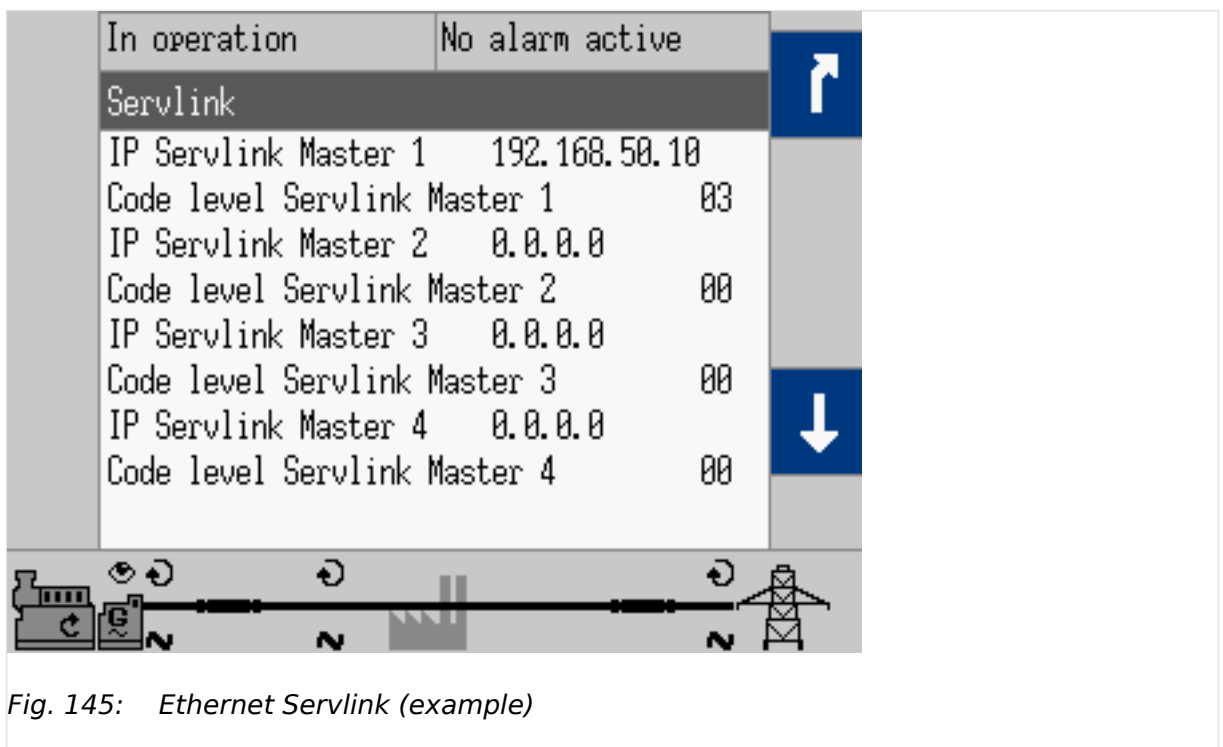

Fig. 145: Ethernet Servlink (example)

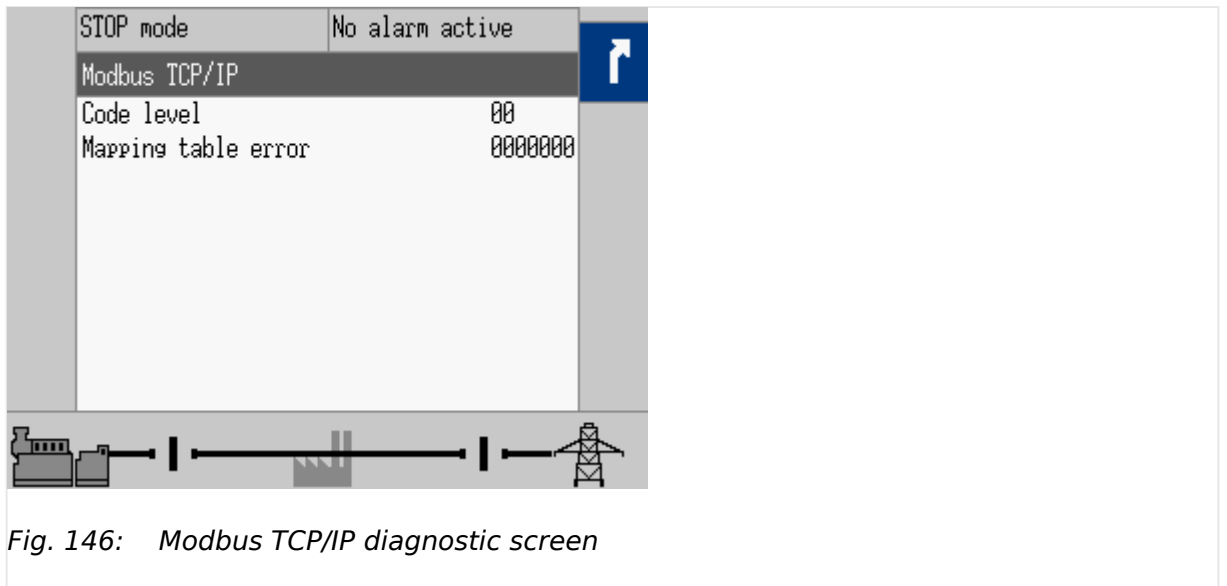

Fig. 146: Modbus TCP/IP diagnostic screen

4.1.5.20 USB

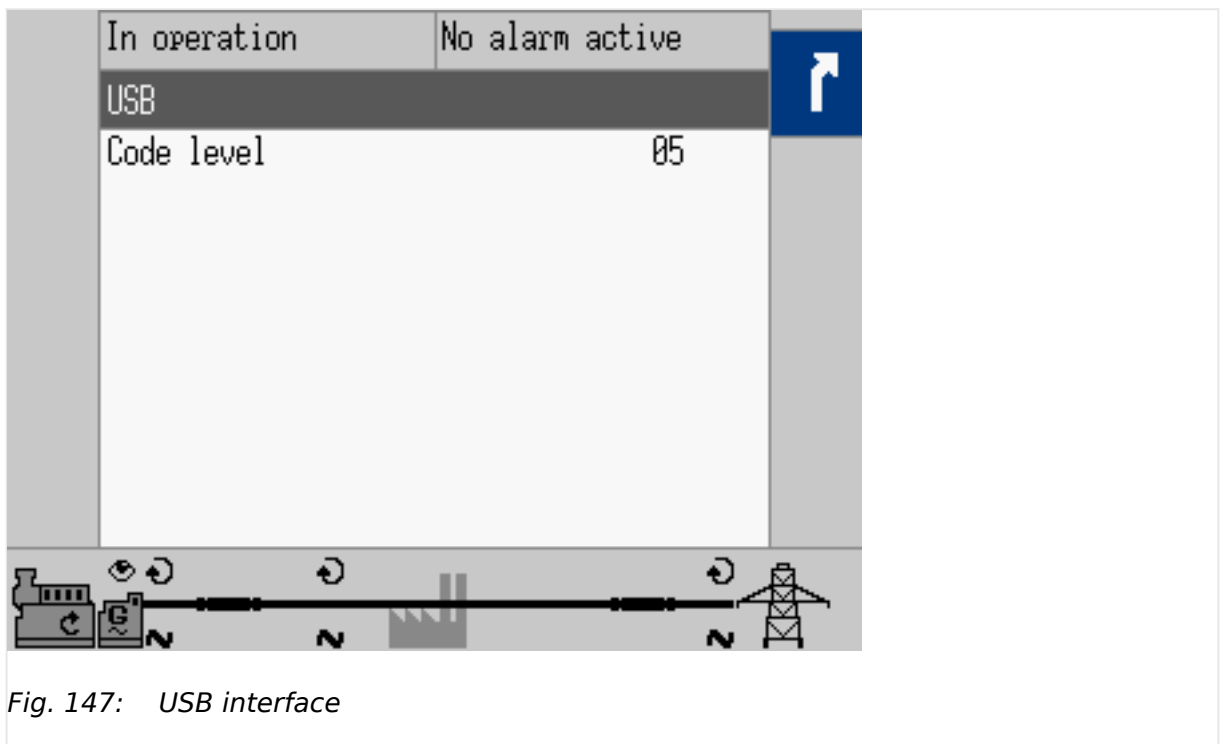

Fig. 147: USB interface

Current USB state is displayed. Setting can be found under [Next Page / Diagnostic / Interfaces / USB].



See chapter [Chapter 4.7.1](#) for configuration.

4.1.5.21 RS-485

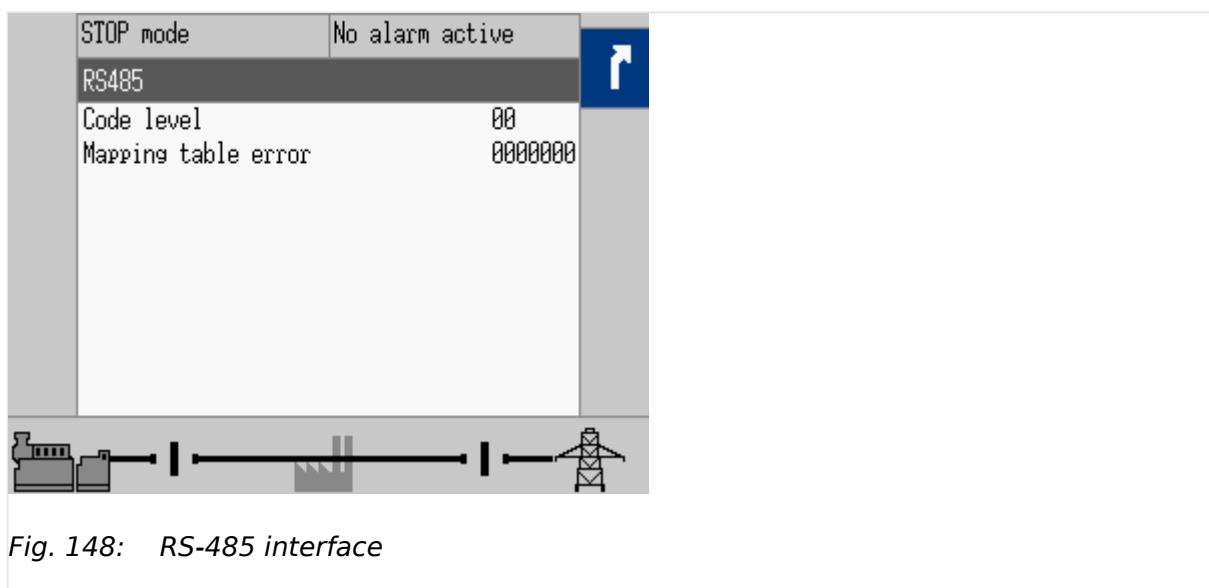

Fig. 148: RS-485 interface

Current RS-485 interface state is displayed. Setting can be found under [Next Page / Diagnostic / Interfaces / RS485].



See chapter [↪ "4.7.2 RS-485 Interface"](#) for configuration.

4.1.5.22 J1939 Special

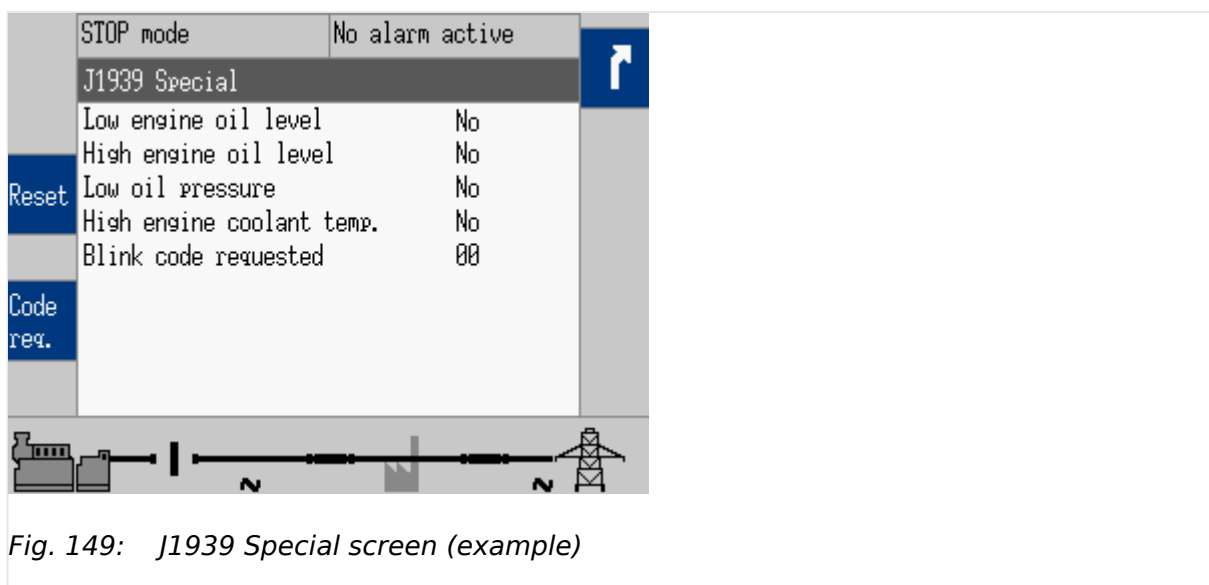



Fig. 149: J1939 Special screen (example)

The status of the configured J1939 ECU error messages is displayed here if the unit is configured accordingly. Some ECUs have a special screen(s) for proprietary features. The example shows the special screen for Scania S6.

 The following softkeys are only visible if parameter  15127 is configured to "ON".

Symbol/Softkey	Description
Code req.	Request a blink code for one error message from the ECU. Repeated pressing of this softkey displays all stored error messages. This symbol/softkey is only visible if the ECU is configured to "Scania S6".
Reset	Scania S6: Reset the blink code. To do this, disable the ignition (terminal U15), press this softkey, and enable the ignition again within 2 seconds. Other ECU: Reset ECU failure codes.

4.1.5.23 J1939 Status miscellaneous

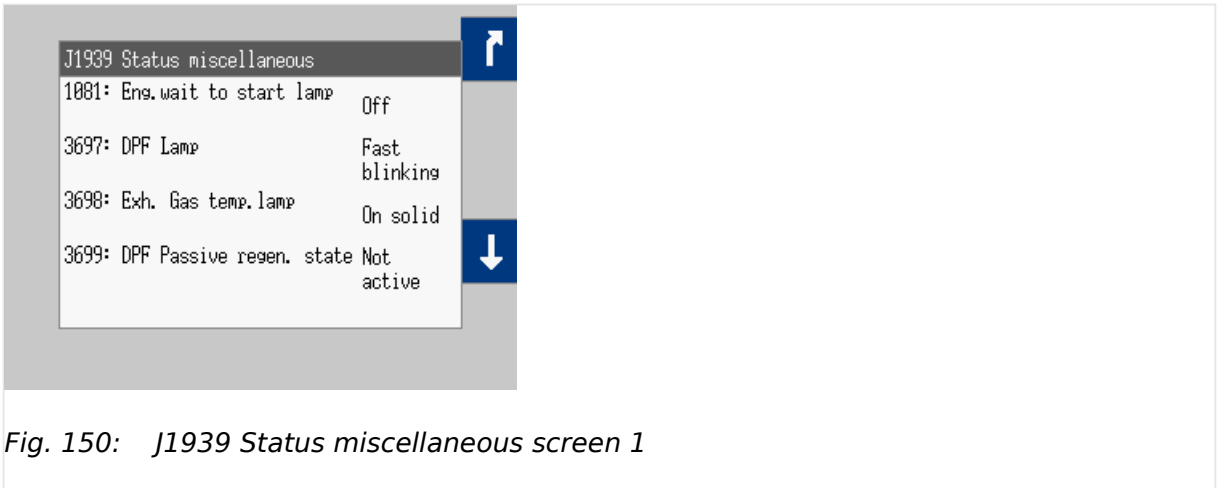

Fig. 150: J1939 Status miscellaneous screen 1

SPN	Description
1081: Eng. wait to start lamp	Engine Wait to Start Lamp: Lamp signal which indicates that the engine is too cold to start and the operator should wait until the signal becomes inactive (turns off). Values: <ul style="list-style-type: none"> • Off • On • Missing
3697: DPF Lamp	Diesel Particulate Filter Lamp Command: Command to control the diesel particulate filter lamp. Values: <ul style="list-style-type: none"> • Off • On solid • Fast blinking • Missing
3698: Exh. Gas temp. lamp	Command to control the exhaust system high temperature lamp: This lamp indicates that the exhaust system temperature is high.

SPN	Description
	Values: <ul style="list-style-type: none"> • Off • On solid • Missing
3699: DPF Passive regen. state	Diesel Particulate Filter Passive Regeneration Status: Indicates the state of diesel particulate filter passive regeneration. Values: <ul style="list-style-type: none"> • Not active • Active • Missing
3700: DPF Active regen. status	Diesel Particulate Filter Active Regeneration Status: Indicates the state of diesel particulate filter active regeneration. Values: <ul style="list-style-type: none"> • Not active • Active • Missing
3701: DPF Regeneration needed	Diesel Particulate Filter Status: Indicates the state of the diesel particulate filter regeneration need and urgency. Values: <ul style="list-style-type: none"> • No • Lowest level • Moderate level • Highest level • Missing
3702: DPF Act. regen. inhibit	Diesel Particulate Filter Active Regeneration Inhibited Status: Indicates the state of diesel particulate filter active regeneration inhibition. Values: <ul style="list-style-type: none"> • Not inhibited • Inhibited • Missing
4332: SCR System state	Aftertreatment 1 SCR System State Values: <ul style="list-style-type: none"> • Dormant • Prep.dos. readiness • Normal dosing • System error • Heat protect. • Cold protect. • Shutoff • Diagnosis • Dosing allowed • Dosing n.allowed • Missing
5245: SCR Inducement (DEF)	Aftertreatment Selective Catalytic Reduction Operator Inducement Active

4 Configuration

4.1.5.24 Time Indication According To Operating Condition

SPN	Description
	Values: <ul style="list-style-type: none"> • OK • Low DEF level • Low DEF level! • Missing
5246: SCR Inducement severity	Aftertreatment SCR operator inducement Severity Operator Inducement Severity Values: <ul style="list-style-type: none"> • OK • Level 1 • Level 2 • Level 3 • Level 4 • Level 5 • Temporary override • Missing
6915: SCR Cleaning Lamp	SCR System Cleaning Lamp Command Values: <ul style="list-style-type: none"> • Off • On solid • Fast blinking • Missing

4.1.5.24 Time Indication According To Operating Condition

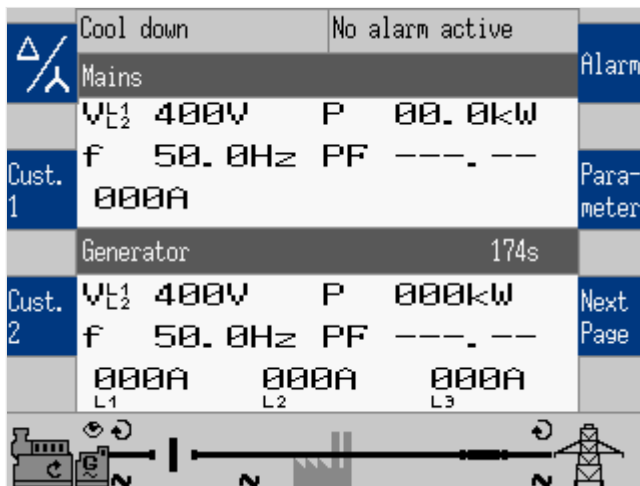

Fig. 151: Time indication according to operating condition

This screen element (on main screen) displays time indications according to the operating condition of the easYgen device. The time indications of the events indicated in the table below are shown in the display. The counter starts with the setting value of the related event and counts down to zero. After that, the status change of another event is shown. The sequence of the events is related on the configuration of the device.

Event	Description
Auxiliary services prerun	Refer to parameter ↪ 3300 for details.
Crank protect	Refer to parameter ↪ 3326 for details (only half of the configured time is used).
Preglow time	Refer to parameter ↪ 3308 for details.
Starter time	Refer to parameter ↪ 3306 for details.
Start pause time	Refer to parameter ↪ 3307 for details.
Ignition delay	Refer to parameter ↪ 3310 for details.
Gas valve delay	Refer to parameter ↪ 3311 for details.
Engine monitoring delay time	Refer to parameter ↪ 3315 for details.
Generator stable time	Refer to parameter ↪ 3415 for details.
Cool down time	Refer to parameter ↪ 3316 for details.
Stop time of engine	Refer to parameter ↪ 3326 for details.
Auxiliary services postrun	Refer to parameter ↪ 3301 for details.

4.2 Access Via PC (ToolKit)

Version



Woodward's ToolKit software is required to access the unit via PC

- Required version: 7.1.1 or higher
- Please use the latest available version!
- To obtain the latest version scan this QR code or use the following link: [⇒ https://wss.woodward.com/manuals/PGC/SW_Tools/ToolKit](https://wss.woodward.com/manuals/PGC/SW_Tools/ToolKit).



NOTICE!



EXISTING wset Settings Files

wset file properties changed. easYgen-XT wset files are different from wset files of easYgen Series.

- wset Settings files created with easYgen must be converted before use with easYgen-XT!
- NEWwset files are NOT BACKWARD COMPATIBLE!
- Please ask your Woodward sales support contact for conversion/update instruction to use files created with easYgen.

4.3 Basic Setup

The "Basic Setup" describes a collection of configuration sub-menus:

- Configure language/clock
- Configure system management
- Password 
- Configure HMI
 - Configure customer screen 1
 - Configure customer screen 2
 - Configure display
 - Screen configuration

(Other configuration is "below" the sub-menu »Configuration«. See following chapters.

4.3.1 Configure Language/Clock

General notes

The following parameters are used to set the unit language, the current date and time, and the daylight saving time feature.



If an Asian language is configured, some parameter screens may be displayed with an empty space at the bottom of the parameter list, which may be interpreted as an end of the list, although more parameters exist and are displayed when scrolling down.

This can easily be checked:

- The list display is a closed loop, so ...
- scrolling UP from first list entry goes to the end of the list and vice versa.



If a custom language is configured, the enumeration text in ToolKit displays "Reserve 1". In the easYgen HMI, the enumeration text is the name of the current custom language.

If the language is set to "Reserve1" without a loaded custom language, the language of the HMI will be set to English.



Update Clock

HMI/display and ToolKit differ in updating the clock settings

- HMI/display shows the actual value and enables direct change of each parameter
- ToolKit displays the »Actual values« (ID 1690 to 1695) besides the parameters. So the time values and date values can be prepared each as a set before transferring.

ID	Parameter	CL	Setting range [Default]	Description
1700	Language (Set language)	0	selectable languages [English]	The desired language for the unit display text is configured here. Available languages are: English, German, Dutch, Spanish, French, Italian, Portugese, Japanese, Chinese, Russian, Turkish, Polish, Slovakian, Finnish, Swedish, Reserve 1.
»Values to be set«				
1710	Hour	0	hour 0 to 23 h [real-time clock]	The hour of the clock time is set here. Example <ul style="list-style-type: none"> • 0 = 0th hour of the day (midnight). • 23 = 23rd hour of the day (11 pm).
1709	Minute	0	0 to 59 min [real-time clock]	The minute of the clock time is set here. Example <ul style="list-style-type: none"> • 0 = 0th minute of the hour • 59 = 59th minute of the hour
1708	Second	0	0 to 59 s [real-time clock]	The second of the clock time is set here. Example <ul style="list-style-type: none"> • 0 = 0th second of the minute • 59 = 59th second of the minute
1698	Transfer time to clock 	2	Yes [No]	Yes transfers the time values to the clock. Notes

4 Configuration

4.3.1 Configure Language/Clock

ID	Parameter	CL	Setting range [Default]	Description
				ALL values are transferred and overwritten - even if you want to change only one.
1711	Day	0	day 1 to 31 [real-time clock]	The day of the date is set here. Example <ul style="list-style-type: none"> • 1 = 1st day of the month. • 31 = 31st day of the month.
1712	Month	0	month 1 to 12 [real-time clock]	The month of the date is set here. Example <ul style="list-style-type: none"> • 1 = 1st month of the year. • 12 = 12th month of the year.
1713	Year	0	year 0 to 99 [real-time clock]	The year of the date is set here. Example <ul style="list-style-type: none"> • 0 = Year 2000 • 99 = Year 2099
1699	Transfer date to clock 	2	Yes [No]	Yes transfers the date values to the clock. Notes ALL values are transferred and overwritten - even if you want to change only one.
4589	Time zone	2	-12 to 14 [0.00]	Time shift in hours between the time zone in which the device is used compared to the absolutely Greenwich Mean Time (GMT). This information is needed to transfer the general time signal into the local real-time clock setting.
»Daylight saving time«				
4591	Daylight saving time	2	On [Off]	On enables the Daylight saving time. The daylight saving time feature enables to automatically adjust the real-time clock to local daylight saving time (DST) provisions. If daylight saving time is enabled, the real-time clock will automatically be advanced by one hour when the configured DST begin date and time is reached and falls back again by one hour when the configured DST end date and time is reached. If the unit is used in the southern hemisphere, the DST function will be inverted automatically, if the DST begin month is later in the year than the DST end month.

ID	Parameter	CL	Setting range [Default]	Description
				<p>Notes</p> <p>Do not change the time manually during the hour of the automatic time change if DST is enabled to avoid a wrong time setting.</p> <p>Events or alarms, which occur during this hour might have a wrong time stamp.</p>
4594	DST begin time	2	0 to 23 h [0]	<p>The real-time clock will be advanced by one hour when this time is reached on the DST begin date.</p> <p>Example</p> <ul style="list-style-type: none"> • 0 h = 0th hour of the day (midnight) • 23 h = 23rd hour of the day (11 pm) <p>Notes</p> <p>This parameter is only displayed, if Daylight saving time (parameter ↩ 4591) is set to "On".</p>
4598	DST begin weekday	2	<p>[Sunday]</p> <p>Monday</p> <p>Tuesday</p> <p>Wednesday</p> <p>Thursday</p> <p>Friday</p> <p>Saturday</p>	<p>The weekday for the DST begin date is configured here</p> <p>Notes</p> <p>This parameter is only displayed, if Daylight saving time (parameter ↩ 4591) is set to "On".</p>
4592	DST begin nth. weekday	2		<p>The order number of the weekday for the DST begin date is configured here.</p>
			[1st]	DST starts on the 1st configured weekday of the DST begin month.
			2nd	DST starts on the 2nd configured weekday of the DST begin month.
			3rd	DST starts on the 3rd configured weekday of the DST begin month.
			4th	DST starts on the 4th configured weekday of the DST begin month.
			Last	DST starts on the last configured weekday of the DST begin month.
			LastButOne	DST starts on the last but one configured weekday of the DST begin month.

4 Configuration

4.3.1 Configure Language/Clock

ID	Parameter	CL	Setting range [Default]	Description
			LastButTwo	DST starts on the last but two configured weekday of the DST begin month.
			LastButThree	DST starts on the last but three configured weekday of the DST begin month.
				<p>Notes</p> <p>This parameter is only displayed, if Daylight saving time (parameter ↩> 4591) is set to "On".</p>
4593	DST begin month	2	1 to 12 [1]	<p>The month for the DST begin date is configured here.</p> <p>Example</p> <ul style="list-style-type: none"> • 1 = 1st month of the year • 12 = 12th month of the year <p>Notes</p> <p>This parameter is only displayed, if Daylight saving time (parameter ↩> 4591) is set to "On".</p>
4597	DST end time	2	0 to 23 h [0]	<p>The real-time clock will fall back by one hour when this time is reached on the DST end date</p> <p>Example</p> <ul style="list-style-type: none"> • 0 h = 0th hour of the day (midnight). • 23 h = 23rd hour of the day (11 pm). <p>Notes</p> <p>This parameter is only displayed, if Daylight saving time (parameter ↩> 4591) is set to "On".</p>
4599	DST end weekday	2	[Sunday] Monday Tuesday Wednesday Thursday Friday Saturday	<p>The weekday for the DST end date is configured here</p> <p>Notes</p> <p>This parameter is only displayed, if Daylight saving time (parameter ↩> 4591) is set to "On".</p>
4595	DST end nth. weekday	2	[1st]	<p>The order number of the weekday for the DST begin date is configured here.</p> <p>DST ends on the 1st configured weekday of the DST begin month.</p>

ID	Parameter	CL	Setting range [Default]	Description
			2nd	DST ends on the 2nd configured weekday of the DST begin month.
			3rd	DST ends on the 3rd configured weekday of the DST begin month.
			4th	DST ends on the 4th configured weekday of the DST begin month.
			Last	DST ends on the last configured weekday of the DST begin month.
			LastButOne	DST ends on the last but one configured weekday of the DST begin month.
			LastButTwo	DST ends on the last but two configured weekday of the DST begin month.
			LastButThree	DST ends on the last but three configured weekday of the DST begin month.
				<p>Notes</p> <p>This parameter is only displayed, if Daylight saving time (parameter ↩ 4591) is set to "On".</p>
4596	DST end month	2	1 to 12 [1]	<p>The month for the DST begin date is configured here.</p> <p>Example</p> <ul style="list-style-type: none"> • 1 = 1st month of the year • 12 = 12th month of the year <p>Notes</p> <p>This parameter is only displayed, if Daylight saving time (parameter ↩ 4591) is set to "On".</p>

Table 44: Parameters Language/Clock Configuration

Example

If daylight saving time starts at 2:00 am on the 2nd Sunday in March and ends at 2:00 am on the 1st Sunday in November, the unit has to be configured like shown in [↩ Table 45](#) to enable an automatic change to daylight saving time and back to standard time.

ID	Parameter	Setting
4591	Daylight saving time	On
4594	DST begin time	2
4598	DST begin weekday	Sunday
4592	DST begin nth. weekday	2nd
4593	DST begin month	3

ID	Parameter	Setting
4597	DST end time	2
4599	DST end weekday	Sunday
4595	DST end nth. weekday	1st
4596	DST end month	11

Table 45: Daylight saving time - configuration example

	USA, Canada		European Union	
Year	DST Begins 2 a.m. (Second Sunday in March)	DST Ends 2 a.m. (First Sunday in November)	DST Begins 1 a.m. UTC=GMT (Last Sunday in March)	DST Ends 1 a.m. UTC=GMT (Last Sunday in October)
2008	March 9, 2008	November 2, 2008	March 30, 2008	October 26, 2008
2009	March 8, 2009	November 1, 2009	March 29, 2009	October 25, 2009
2010	March 14, 2010	November 7, 2008	March 28, 2010	October 31, 2010

Table 46: Daylight saving time - exemplary dates

Localization Tool (for customized language

*	<p>Create a customized localization of an easYgen 3000XT HMI</p> <p>The LocalizationTool is a tool which allows the user to create a localization of an easYgen3000XT HMI in a selected language and create from this a package which can be updated to the device. Creating localized text is done using Excel which has to be installed on the PC. The tool will create a basic Excel sheet. The user will translate in Excel and then from the edited Excel sheet will create a resource file which can be uploaded on the easYgen using the Woodward ToolKit tool.</p> <p>Additionally the tool provides a simulation of the easYgen’s HMI to check the translation. It also provides a way to re-use previously translated texts.</p> <p>The Localization tool software “LocalizationToolInstaller.msi” can be downloaded via the QR Code server or from the Woodward web site (⇒ https://www.woodward.com). It needs to be installed before use at your PC/laptop. After starting the program, the HELP file can guide through the required settings.</p>
---	---

4.3.2 Configure HMI

4.3.2.1 Configure Customer Screens

easYgen-3000XT comes with two **fully customizable screens - just one click (one level) from home screen**. Softbutton text and displayed name, values, and units can be defined/selected. The new full-featured AnalogManager 1:1 parameter monitoring but even math. function computing.

	<p>There are two configurable customer screens available.</p> <p>Handling/set-up is similar so described one time only.</p>
---	---

The (configurable) names of the customer screens are displayed at  home page as softbutton text. Pressing one of this softbuttons opens the screen with the configured Names, Values, and Units.

Customer Screen Configuration



Numbering convention

Customer Screen X.Y: Screen #X (1 or 2); Row #Y (1 to 9)



ID	Parameter	CL	Setting range [Default]	Description
AM Customer screen 1.1				
7691	Description	2	23 characters [Cust. Screen row 1]	Name displayed in row 1 Notes The max. number of characters is higher but will not be displayed correctly on HMI/display. The row is hidden if description is empty (no character, not even a blank)!
7692	Unit	2	6 characters [Unit]	Unit displayed in row 1 Notes The max. number of characters is higher but will not be displayed correctly on HMI/display. Notes If »°C« or »bar« is assigned the unit will be converted into "°F" or "psi" automatically if the corresponding parameter for conversion  3630 and/or  3631 is configured to YES.
7690	AM Customer screen 1.1	2	Determined by AnalogManager 90.01 [Pass Through, ...]	For details see  Fig. 241.
7934	Decimal points	2	0 to 2 [2]	Number of decimal points for the value in row 1-9 of the customizable screen 1.

Table 47: Parameters Customer Screen 1.1 Configuration (sample)

AM Customer screen #	ID "Description"	ID "Unit"	ID "Decimal points"	AnalogManager
1.1	7691	7692	7932	7690
1.2	7696	7697	7933	7695
1.3	7701	7702	7934	7700
1.4	7706	7707	7935	7705

4 Configuration

4.3.2.1 Configure Customer Screens

AM Customer screen #	ID "Description"	ID "Unit"	ID "Decimal points"	AnalogManager
1.5	7711	7712	7936	7710
1.6	7716	7717	7937	7715
1.7	7721	7722	7938	7720
1.8	7726	7727	7939	7725
1.9	7731	7732	7940	7730
2.1	7736	7737	7941	7735
2.2	7741	7742	7942	7740
2.3	7746	7747	7943	7745
2.4	7751	7752	7944	7750
2.5	7756	7757	7945	7755
2.6	7761	7762	7946	7760
2.7	7766	7767	7947	7765
2.8	7771	7772	7948	7770
2.9	7776	7777	7949	7775

Table 48: Overview Customer Screens/Rows IDs

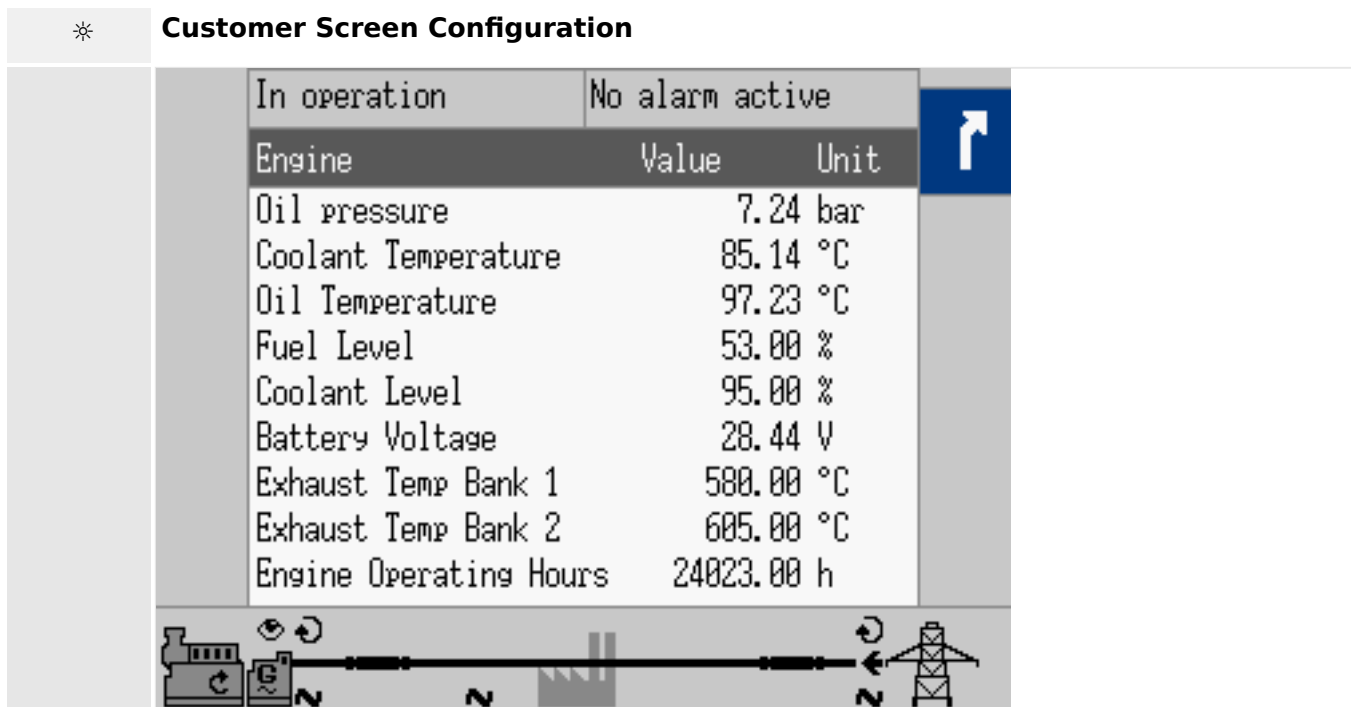

Fig. 152: Customer Screen sample: a set of interesting Engine values

ID	Parameter	CL	Setting range [Default]	Description
7701	Description	2	Oil Temperature	(Defined by customer)
7702	Unit	2	°C	(Defined by customer)
7700	AM Customer screen 1.3	2	Determined by AnalogManager 90.03: »Pass Through« of »A1= 07.23 175:Oil Temperature 1«	(Defined by customer)
7934	Decimal points	2	2	(Defined by customer)

Table 49: Parameters Customer Screen 1.3 Configuration sample

4.3.2.2 Configure Display

Display Configuration

ID	Parameter	CL	Setting range [Default]	Description
	Display brightness	2	0 to 100% [35%]	Color bar visualization for immediately displayed selection
7796	2nd display brightness	2	1 to 100% [5%]	Level of 2nd brightness. Used if LM  7794 is true.
4557	Key activation time	2	1 to 999 min [120 min]	If no soft key has been pressed for the time configured here, the 2nd display brightness will be used.
				Notes



ID	Parameter	CL	Setting range [Default]	Description
				This parameter is only effective, if LogicsManager 86.33 2nd disp. bright. ↩ 7794 is configured to "04.64 Key activation".
7794	Enable 2nd display brightness	2	Determined by LogicsManager 86.33 [(04.64 NOT& 1) & 1] = 11971	<p>Once the conditions of the LogicsManager have been fulfilled, the brightness level of the display switches to the 2nd brightness level defined by parameter ↩ 7796.</p> <p>This can save energy and support visualization of device/system state.</p> <p>For information on the LogicsManager and its default settings see ↩ 4.8 Configure LogicsManager ↩ 9.3.1 LogicsManager Overview.</p>
7799	Enable front foil heater	2	Determined by LogicsManager 86.34 [(1 & 1) & 1] = 11972	<p>If this parameter is TRUE and ambient temperature goes below -10° C, the display (front panel) will be heated for seven minutes (and wait further 3minutes).</p> <p>For information on the LogicsManager and its default settings see ↩ 4.8 Configure LogicsManager ↩ 9.3.1 LogicsManager Overview.</p> <p>Notes</p> <p>This parameter is always visible in HMI and ToolKit, even it is implemented in "-LT" variants for enhanced temperature use only.</p>
12978	Lock keypad 1 	2	Determined by LogicsManager 86.30 [(0 & 1) & 1] = 11924	<p>Key pad can be locked remotely. (For details refer to ↩ 4.1.2 The HOME Screen.)</p> <p>This parameter is intentionally not available via HMI/display.</p> <p>For information on the LogicsManager and its default settings see ↩ 4.8 Configure LogicsManager ↩ 9.3.1 LogicsManager Overview.</p>

Table 50: Parameters Display Configuration

4.3.2.3 Screen configuration

Screen Configuration

ID	Parameter	CL	Setting range [Default]	Description
4103	Home screen data	2		 : Home screen can display several pre-defined data collections.
			Generator	Generator relevant information are displayed.
			[Generator/Mains]	Home screen is splitted and displays generator and mains related information.
			Generator/Busbar	Home screen is splitted and displays generator and busbar related information.
			Generator/Engine	Home screen is splitted and displays generator and engine related information.
			Generator/LSx/GC	Home screen is splitted and displays generator and LSx related information.
4129	Online diagram with mains	2	Off [On]	 : Display of oneline (single line) diagram on home screen can be reduced NOT to show mains symbols. Notes Softbutton for MCB is (visible and) valid only if this parameter is TRUE.
4147	GC Online diagram with GGB (Only visible if "Home screen data" is configured to "Generator/LSx/GC".)	2	Off]	The GGB is faded out.
			[On]	The physical GGB condition is indicated
			Load-linkage	The load-linkage (generator load bus bar) is indicated.

General notes

The home screen data configuration "Generator/Engine" offers an engine value indication. With the following AnalogManagers the according sources can be configured and scaled.



The according AnalogManager has to be configured as 'Pass Through'.

ID	Parameter	CL	Setting range [Default]	Description
8891	AM Engine speed	2	Determined by AnalogManager 81.24	With this AnalogManager the according speed source may be

4 Configuration

4.3.2.3 Screen configuration

ID	Parameter	CL	Setting range [Default]	Description
			[A1 = 11.51 Engine speed [rpm]]	<p>selected from the available data sources.</p> <p>Even it is possible to select all data sources (↳ "9.4.2 Data Sources AM"), only the following data source may be used:</p> <p>11.51 Engine speed [rpm]</p> <p>The indication is displayed in the format 0000 rpm.</p>
8892	Show engine speed	2	[Yes] No	Display of engine speed on home screen.
8893	AM Engine oil pressure	2	Determined by AnalogManager 81.25 [A1 = 07.07 100:Engine Oil Press.] (This default value is a J1939 value.)	<p>With this AnalogManager the according oil pressure source can be configured and scaled. The indication is displayed in the format 00.0bar (000psi).</p> <p>Notes</p> <p>If »bar« is assigned the unit will be converted into "psi" automatically if the corresponding parameter for conversion (↳ 3630) is configured to YES.</p>
8894	Show engine oil pressure	2	Yes [No]	Display of engine oil pressure on home screen.
8895	AM Engine hours	2	Determined by AnalogManager 81.26 [A1 = 11.55 Eng.oper.hours [h]]	With this AnalogManager the according operating hours source can be configured and scaled. The indication is displayed in the format 00000.00h .
8896	Show engine hours	2	[Yes] No	Display of engine running hours on home screen.
8897	AM Engine fuel level	2	Determined by AnalogManager 81.27 [A1 = 06.03 Analog input 3]	With this AnalogManager the according fuel level source can be configured and scaled. The indication is displayed in the format 000.0% .
8898	Show engine fuel level	2	Yes [No]	Display of engine fuel level on home screen.
8899	AM Engine batt.voltage	2	Determined by AnalogManager 81.28 [A1 = 10.54 Battery voltage [V]]	With this AnalogManager the according battery voltage source can be configured and scaled. The indication is displayed in the format 00.0V .
8900	Show engine battery voltage	2	[Yes] No	Display of engine battery voltage on home screen.
8901	AM Engine coolant temp.	2	Determined by AnalogManager 81.29	With this AnalogManager the according coolant temperature source can be configured and

ID	Parameter	CL	Setting range [Default]	Description
			[A1 = 07.15 110:Eng.Coolant Temp.] (This default value is a J1939 value.)	<p>scaled. The indication is displayed in the format 000°C (°F).</p> <p>Notes</p> <p>If »°C« is assigned the unit will be converted into "°F" automatically if the corresponding parameter for conversion ↪ 3631 is configured to YES.</p>
8902	Show engine coolant Temp.	2	[Yes] No	Display of engine coolant temperature on home screen.

4.3.3 Lamp Test



All lights on the controller may be tested for correct operation with this function.

[Parameter / Lamp test]

Lamp test is available via HMI/display, ToolKit and LogicsManager ([↪ 12884](#)) and activates parameter 10773 with logical command variable 04.61.

4.3.4 Enter Password

General notes

The controller utilizes a password protected multi-level access hierarchy to prevent unauthorized access to parameters, configuration and calibration items. This permits varying degrees of access to the parameters being granted by assigning unique passwords to designated personnel.

Password protection covers direct and remote access through all methods and interfaces of interconnectivity of the device.



Personal security

Configure password security before handing over the device to the customer!

Note your password on a secure location. The next higher password level (2 and 4) allows to reset the password of the level below (1 and 3).

To restore the according User Name Account needs support from Woodward (authorized partner).

Access via channel ...

The following table and drawing provide an overview about the possible access channels to the easYgen-XT.

Access to the easYgen-XT by a/an ...	# used in drawing  "Access via channel ..." below
HMI on the control directly	①
PC running ToolKit servlink, connected over USB	②
Remote Panel with the Woodward screen share concept connected over Ethernet (HMI simulation)	③ = ①
3rd party Remote Panel (i.e. Proface, Süttron, ...) running Modbus TCP	④
PLC running Modbus TCP	④
PC running ToolKit servlink, connected over Ethernet	⑤
Netbiter® Easy Connect gateway running Servlink TCP (ToolKit via internet)	⑤
PLC running Modbus RTU via RS-485	⑥
PLC running CANopen	⑦
PLC running CANopen via Profibus DP	⑦



Each channel has its own independent access level.

The according password handling for each of this access is defined afterwards.

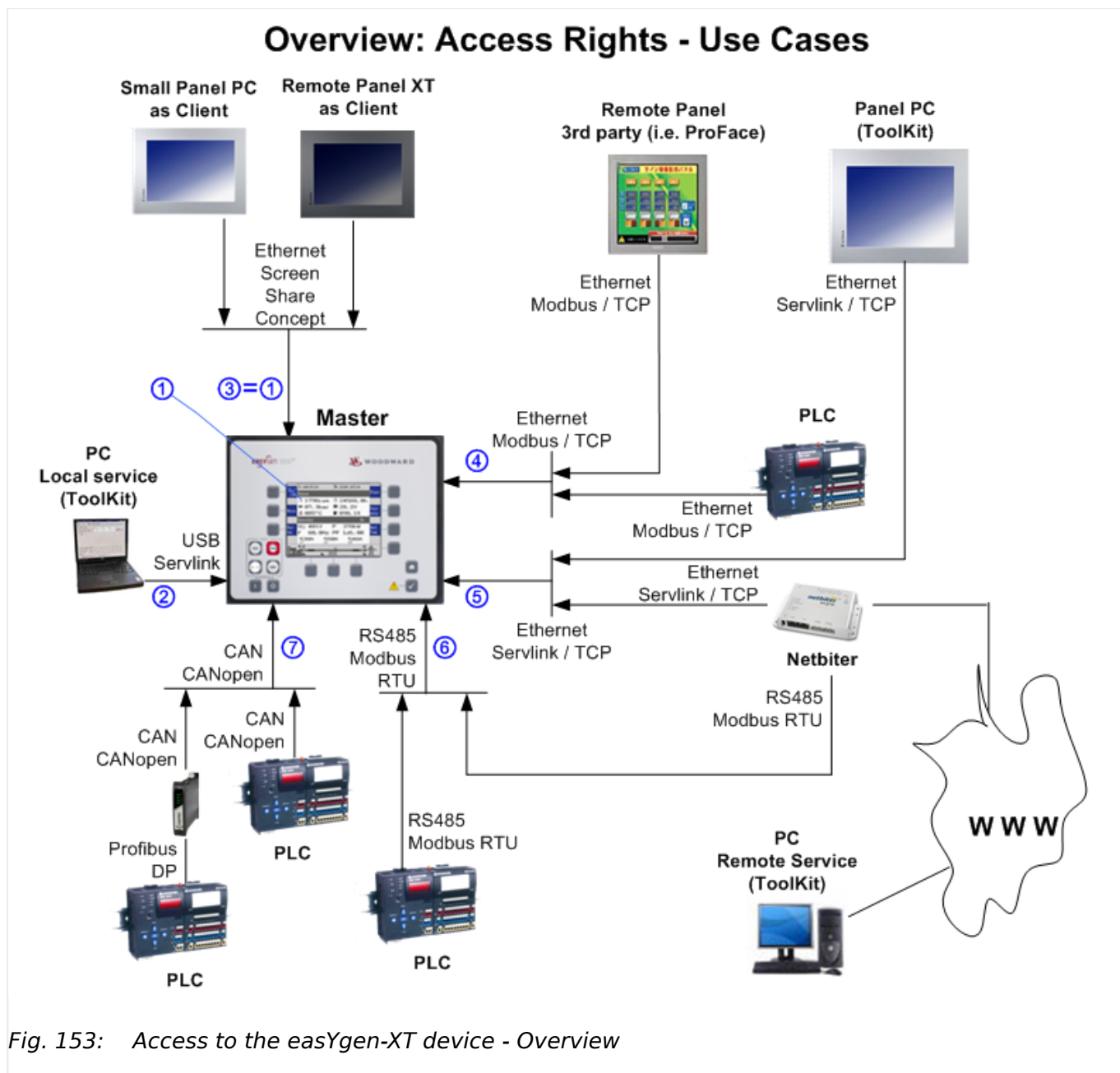

Fig. 153: Access to the easYgen-XT device - Overview

Two login procedures cover all access channel variants: The ...

- Basic Code Entry
- User Account Entry



Hidden entry for more security

The currently selected entry number is visible only - all other numbers are hidden and a "*" asterisk is displayed instead.

LOGIN procedure "Basic Code Entry"

The Basic Code Entry is valid for access ①, ③, ⑥, and ⑦.

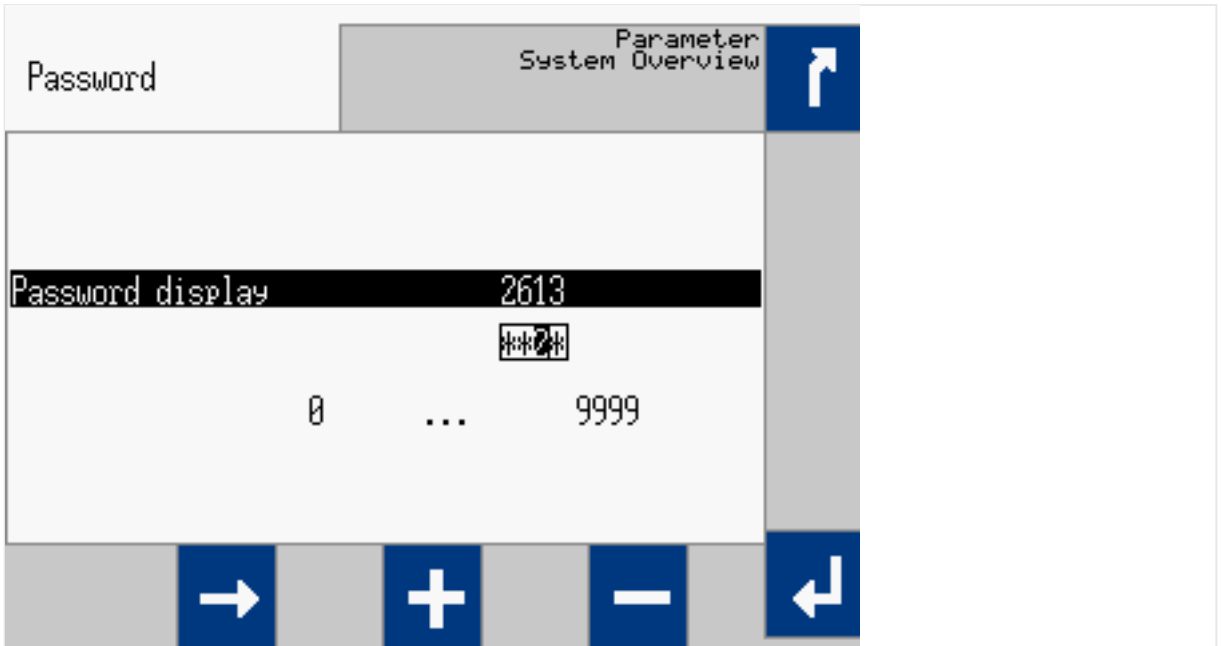

Fig. 154: Password entry: HMI

The Basic Code Entry asks for four numbers to open the related password level. It starts with the default value of parameter \hookrightarrow 10416 »Random number for password«.

LOGIN procedure "User Account Entry"

The User Account Entry is valid for access ②, ④, and ⑤.

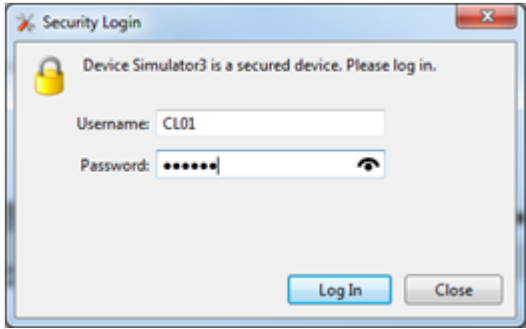



Fig. 155: Password entry: ToolKit

The User Account Entry comes with more security as requested for internet access. It asks for »Username:« **and** »Password:« ("Alphanumeric Password"). To open the related password level, both rows entries need the correct alphanumeric strings.

i The already existing User names cannot be changed. They are fixed for the desired code level, which shall be entered.

i **Check you Password entry**
 View hidden password entry by pushing the  symbol on the right side of the »Password:« box.

Enter Password for level ... (Overview)

A distinction is made between the access levels as follows:

Code Level	User Account Entry		Basic Code Entry	Comment
	User Name (fix)	Password (default)	Password (default)	
5	CL05	CL0500	500	<p>The Super Commissioning Level</p> <p>Access to nearly all parameters and configurations, except calibration and super user items.</p> <p>The firmware updating is released.</p> <p>The own code level and the levels below can be indicated and configured.</p>
4	AC04	Algorithm Code	Algorithm Code	<p>The temporary Super Commissioning Level</p> <p>The same access rights like in the Super Commissioning Level but with the following exceptions:</p> <ul style="list-style-type: none"> • The password for this level is not visible. • The access is dismissed afterwards.
3	CL03	CL0003	3	<p>The Commissioning Level</p> <p>Access to well defined parameters and configurations, which are usually needed on a commissioning level.</p> <p>The own code level and the levels below can be indicated and configured.</p>
2	AC02	Algorithm Code	Algorithm Code	<p>The temporary Commissioning Level</p> <p>The same access rights like in the Commission Level.</p> <p>The Code level is entered in an algorithm code. The access is dismissed afterwards.</p> <p>Only the code levels below can be indicated and configured.</p>
1	CL01	CL0001	1	<p>The Basic Level</p> <p>Access to a limited number of parameters and configurations.</p> <p>The own code level can be indicated and configured.</p>
0				<p>No access rights to change, even viewed information is restricted.</p>



Active Code Level

A code level always belongs to an access channel. Each access channel has its own password level. This password level can be different to others (other channels) at the same time.

The access related code level is available and visible beside the access related interface settings.



No direct access as expected?

Please check: LogicsManager 86.30 Parameter 12978 "Lock keypad 1" = TRUE?

The Algorithm Code

The "Algorithm Code" is an implemented procedure to give an external user temporarily access to the device but without being able to see or change the according passwords. This temporary access needs a random number produced by the device. The actual password then is calculated from this random number using a secret formula. The secret formula is provided by a higher instance.

Access Channels



Maximum Security

Each of these channels have their own independent access level. That has the advantage that e.g. a HMI channel password level opens not automatically the access rights for the other channels.



Maximum Flexibility

The device offers the capability to disable the password protection for the individual interface communication channels RS485, Ethernet, CAN 1 and CAN 3. If the password level is disabled the access level is set on code level 5.

The device provides different access channels via ...	Remarks
HMI directly or by WW Remote Panel	screen share concept
USB	ToolKit Servlink
RS485	Modbus RTU
Ethernet	Modbus TCP
	ToolKit Servlink TCP, 8 sub channels are possible Note: Each of the 8 sub channels has its own independent password access level!
CAN1	CANopen
CAN2	
CAN3	

The different Password Code Levels

This chapter defines the properties of the single password code levels. The device differentiates several password levels. Generally with a higher reached password level the access rights increases.

Code Level 0

The Level 0 means there are no access rights enabled. All configurations are blocked.

Code Level 1 - The Basic Level CL01

- **General:**

This level releases the access to a limited number of parameters and configurations

- **Basic Code entry:**

In this and higher levels the password for the Basic Code Level CL01 can be changed

- **User Account Entry:**

This level is selected with the User Name CL01 and the according password can only be changed being in code level CL01.

Being in code level AC02 or higher the password of the Basic Level CL01 can be reset to its default by the Yes/No parameter [↩ 10434](#).

Code Level	User Account Entry		Basic Code Entry
	User Name (fix)	Password (default)	Password (default)
1	CL01	CL0001	0001

Code Level 2 - The temporary Commissioning Level AC02

- **General:**

This Level allows temporary access to parameters of the Commission Level.

The access is dismissed automatically (see [↩ "Automatic Logout from Password level \(Fall into level 0\)"](#)).

- **Basic Code Entry:**

In this and higher Levels, the password for the Basic Code Level CL01 can be changed.

- **User Account Entry:**

This level is selected with the User Name AC02 and the according algorithm for the password can only be changed being in the Commissioning code level CL03.

Being in code level AC02 or higher the password of the Basic Level CL01 can be reset to its default by the Yes/No parameter [↩ 10434](#).

Code Level	User Account Entry		Basic Code Entry
	User Name (fix)	Password	Password
2	AC02	<p>The entry procedure:</p> <p>The operator connects ToolKit with the device and closes the upcoming security login window without entering username and password (Code level 0). The operator navigates with ToolKit to the page [Parameter / Configure system management].</p> <p>The operator reads on that page ↩➤ 10416 »Random number for password«. He tells it to a higher instance.</p> <p>The higher instance calculates: (10414 »Code temp. commissioning« + 10416 »Random Number«) x 3.</p> <p>The higher instance takes the lower four digits of the result and puts the according algorithm string 10437 »Alphanumeric code temp. comm.« as prefix in front.</p> <p>The higher instance tells the result to the operator, who enters the result as password into the control.</p>	<p>The entry procedure:</p> <p>The operator navigates on the easYgen-XT HMI or on RP-3000XT to the screen[Parameter / Password / Password display].</p> <p>The operator reads the indicated random number. He tells it to a higher instance.</p> <p>The higher instance calculates: (10414 »Code temp. commissioning« + 10416 »Random Number«) x 3.</p> <p>The higher instance takes the lower four digits of the result and tells it the operator. The operator enters the result as password into the control.</p>

Code Level 3 - The Commissioning Level CL03

- **General:**

In this Level, the operator has access to all parameters and configurations, which are usually needed on a commissioning level

- **Basic Code Entry:**

In this and higher levels the password for the Commissioning Level CL03 can be changed

- **User Account Entry:**

This level is selected with the User name CL03 and the according password can only be changed being in the Commissioning Level CL03

Being in code level AC04 or higher the password of the Commissioning Level CL03 can be reset to its default by the Yes/No parameter ID [↩➤ 10435](#)

Level	User Account Entry		Basic Code Entry
	User Name (fix)	Password (default)	Password (default)
3	CL03	CL0003	0003

Code Level 4 - The temporary Super Commissioning Level

- **General:**

This Level allows temporary access to nearly all parameters and configurations, except calibration and super user items.

The access is dismissed automatically

- **Basic Code Entry:**

In this and higher levels the passwords for the Commissioning Level CL04 can be changed

- **User Account Entry:**

This level is selected with the User name AC03 and the according algorithm for the password can only be changed being in the Super Commissioning Level CL05

Being in code level AC04 or higher the password of the Commissioning Level CL03 can be reset to its default by the Yes/No parameter ID [↩➤ 10435](#)

Level	User Account Entry		Basic Code Entry
	User Name	Password	Password
4	AC04	<p>The entry procedure:</p> <p>The operator connects ToolKit with the device and closes the upcoming security login window without entering username and password (Code level 0). The operator navigates with ToolKit to the page [Parameter / Configure system management].</p> <p>The operator reads on that page ↩➤ 10416 »Random number for password«. He tells it to a higher instance.</p> <p>The higher instance calculates: (10412 »Code temp. commissioning« + 10416 »Random Number«) x 5.</p> <p>The higher instance takes the lower four digits of the result and puts the according algorithm string 10438 »Alphanumeric code super temp. comm.« as prefix in front.</p> <p>The higher instance tells the result to the operator, who enters the result as password into the control.</p>	<p>The entry procedure:</p> <p>The operator navigates on the easYgen-XT HMI or on RP-3000XT to the screen[Parameter / Password / Password display].</p> <p>The operator reads the indicated random number. He tells it to a higher instance.</p> <p>The higher instance calculates: (10412 »Code temp. commissioning« + 10416 »Random Number«) x 5.</p> <p>The higher instance takes the lower four digits of the result and tells it the operator. The operator enters the result as password into the control.</p>

Code Level 5 - The Super Commissioning Level CL05

- **General:**

In this Level, the operator has access to nearly all parameters and configurations, except calibration items

The firmware updating is released

- **Basic Code Entry:**

In this and higher Levels the password fro the Super Commissioning Level CL05 can be changed

- **User Account Entry:**

This level is selected with the User name CL05 and the according password can only be changed being in the Super Commissioning Level CL05

Being in a higher level as CL05 the password of the Super Commissioning Level CL05 can be reset to its default by the Yes/No parameter ID [↔ 10436](#)



If you have forgotten your password for the Super Commissioning Level, please contact Woodward or a representative for help.

Level	User Account Entry		Basic Code Entry
	User Name (fix)	Password (default)	Password (default)
5	CL05	CL0500	0500

Automatic Logout from Password level (Fall into level 0)

All basic code entry channels deny after 2h

The Modbus TCP access channel denies after 2h

Generally with power supply cycling the password level is denied.

The ToolKit Servlink access never logout

What forces the Logout from Password levels (Fall into level 0)

All basic code entry channels with »0« as password or a wrong password

The ToolKit Servlink access with logout function

The Modbus TCP (in all channels) with wrong password



Definition of the password

Numeric Password of the Basic Code entry

- The range of possible passwords is 1 to 9999

Alpha numeric Password of the User Account entry

- The maximum length of the alpha numeric password is 20 characters

- The maximum length of the alpha numeric prefix (ID  10437;  10438) is 6 characters

The Random Number

Each time a password is entered, the random number is calculated at new. This guarantees max. security.

Password handling on the HMI of the easYgen

The easYgen supports only the Basic Code entry.

The easYgen HMI password level shall be visible in the parameter menu screens.

A dynamic key symbol is visible and displays the currently entered code level number inside:

- code level = 00: locked
- code level > 00: unlocked

In case of a password level time out during configuration over HMI, the HMI display switches back to the main screen.

The Input of the code level number or string contains a disguise function.

Password handling in ToolKit

The ToolKit supports the User Account entry and in case of CANopen connection the Basic Code entry.

Ethernet Connection: The ToolKit password level is visible in the menu [STATUS MENU / Diagnostic / Interfaces / Ethernet / Servlink]. Refer to your IP-address (PC).

USB Connection: The ToolKit password level is visible in the menu [STATUS MENU / Diagnostic / Interfaces / USB].

CAN Connection: The ToolKit password level is visible in the menu [STATUS MENU / Diagnostic / Interfaces / CAN / CAN 1 state - CAN 3 state].

Password handling via Modbus TCP using Ethernet connection

The easYgen must be a member of an Ethernet network and both user name and password have to be transferred (from PLC) to the device.

✧ **Procedure for CAN 1**

- CAN interface 1 Parameter ID = 10402 (dec) = 28A2 (hex)
- Incorporate the 2000 (hex) value: 28A2(hex) + 2000 (hex) = 48A2 (hex)
- Identifier: 600 (hex) + Node-ID
- Example Node-ID is 1

The following table shows exemplary send data for the device on the CANopen bus.

Identifier	Description	Data (hex)
601 (hex)	Password 500 writing on Parameter ID 10402	2B A2 48 01 F4 01 00 00

Code level state can be read with parameter 10407.

Please find the password level in ToolKit: [STATUS MENU / Diagnostic / Interfaces / CAN / CAN 1 state].

✧ **Procedure for CAN 2**

- CAN interface 2 Parameter ID = 10432 (dec) = 28C0 (hex)
- Incorporate the 2000 (hex) value: 28C0 (hex) + 2000 (hex) = 48C0 (hex)
- Identifier: 600 (hex) + Node-ID
- Example Node-ID is 1

The following table shows exemplary send data for the device on the CANopen bus.

Identifier	Description	Data (hex)
601 (hex)	Password 500 writing on Parameter ID 10432	2B C0 48 01 F4 01 00 00

Code level state can be read with parameter 10422.

Please find the password level in ToolKit: [STATUS MENU / Diagnostic / Interfaces / CAN / CAN 2 state].

✧ **Procedure for CAN 3**

- CAN interface 3 Parameter ID = 10433 (dec) = 28C1 (hex)
- Incorporate the 2000 (hex) value: 28C1 (hex) + 2000 (hex) = 48C1 (hex)
- Identifier: 600 (hex) + Node-ID
- Example Node-ID is 1

The following table shows exemplary send data for the device on the CANopen bus.

Identifier	Description	Data (hex)
601 (hex)	Password 500 writing on Parameter ID 10433	2B C1 48 01 F4 01 00 00

Code level state can be read with parameter 10423.

Please find the password level in ToolKit: [STATUS MENU / Diagnostic / Interfaces / CAN / CAN 3 state].

Code level display

The current code level is indicated by the lock symbol in the configuration menu screens. The lock symbol indicates the number of the code level and appears as "locked" (in code level CL00) or "unlocked" (in higher code levels).

Symbol	Status
	Locked
	Unlocked (Code Level 01)

ID	Parameter	CL	Setting range [Default]	Description
10400	Password display	0	0000 to 9999 [random number]	The password for configuring the control via the front panel must be entered here.
10405	Code level display	0	(display only) [0]	This value displays the code level which is currently enabled for access via the front panel display or the Woodward Remote Panel with screen share mode.

Code level interfaces

The password and/or User name for access via interface cannot be entered via HMI.

ID	Parameter	CL	Setting range [Default]	Description
10402	Password for CAN interface 1	0	0000 to 9999 [random number]	The password for configuring the control via the CAN interface #1 must be entered here. Not visible but can be accessed by interface!
10407	Code level	0	[0]	This value displays the code level which is currently enabled for access via the CAN interface #1.
10432	Password for CAN interface 2	0	0000 to 9999 [random number]	The password for configuring the control via the CAN interface #2 must be entered here. Not visible but can be accessed by interface!
10422	Code level	0	[0]	This value displays the code level, which is currently enabled for access via the CAN interface #2.
10433	Password for CAN interface 3	0	0000 to 9999 [random number]	The password for configuring the control via the CAN interface #3 must be entered here. Not visible but can be accessed by interface!

ID	Parameter	CL	Setting range [Default]	Description
10423	Code level	0	[0]	This value displays the code level, which is currently enabled for access via the CAN interface #3.
7486	Code level	0	[0]	This value displays the code level, which is currently enabled for access via the USB interface. The password is entered via the ToolKit login window.
10430	Password for serial interface	0	0000 to 9999 [random number]	The password for configuring the control via the RS485 interface must be entered here. Not visible but can be accessed by interface!
10420	Code level	0	[0]	This value displays the code level, which is currently enabled for access via the RS485 interface.
7490	User name Modbus TCP	0		The user name for configuring the control via the Modbus TCP/IP interface must be entered here. Not visible but can be accessed by interface!
7491	Password Modbus TCP	0	0000 to 9999 [random number]	The password for configuring the control via the Modbus TCP/IP interface must be entered here. Not visible but can be accessed by interface!
10427	Code level	0	[0]	This value displays the code level, which is currently enabled for access via the Modbus TCP/IP interface.
7816	IP Servlink Master 1	0	[0]	This is the IP address of the PC that is connected via ToolKit with the device as Servlink Master 1.
7824	Code level Servlink Master 1	0	[0]	This value displays the code level, which is currently enabled for access as Servlink Master 1.
7817	IP Servlink Master 2	0	[0]	This is the IP address of the PC that is connected via ToolKit with the device as Servlink Master 2.
7825	Code level Servlink Master 2	0	[0]	This value displays the code level, which is currently enabled for access as Servlink Master 2.
7818	IP Servlink Master 3	0	[0]	This is the IP address of the PC that is connected via ToolKit with the device as Servlink Master 3.
7826	Code level Servlink Master 3	0	[0]	This value displays the code level, which is currently enabled for access as Servlink Master 3.
7819	IP Servlink Master 4	0	[0]	This is the IP address of the PC that is connected via ToolKit with the device as Servlink Master 4.

ID	Parameter	CL	Setting range [Default]	Description
7827	Code level Servlink Master 4	0	[0]	This value displays the code level, which is currently enabled for access as Servlink Master 4.
7820	IP Servlink Master 5	0	[0]	This is the IP address of the PC that is connected via ToolKit with the device as Servlink Master 5.
7828	Code level Servlink Master 5	0	[0]	This value displays the code level, which is currently enabled for access as Servlink Master 5.
7821	IP Servlink Master 6	0	[0]	This is the IP address of the PC that is connected via ToolKit with the device as Servlink Master 6.
7829	Code level Servlink Master 6	0	[0]	This value displays the code level, which is currently enabled for access as Servlink Master 6.
7822	IP Servlink Master 7	0	[0]	This is the IP address of the PC that is connected via ToolKit with the device as Servlink Master 7.
7830	Code level Servlink Master 7	0	[0]	This value displays the code level, which is currently enabled for access as Servlink Master 7.
7823	IP Servlink Master 8	0	[0]	This is the IP address of the PC that is connected via ToolKit with the device as Servlink Master 8.
7831	Code level Servlink Master 8	0	[0]	This value displays the code level, which is currently enabled for access as Servlink Master 8.

4.3.4.1 Password System - Parameter Overview

General notes



The following passwords grant varying levels of access to the parameters.

Each individual password can be used to access the appropriate configuration level through multiple access methods and communication protocols (via the front panel, via serial RS-485 interface, and via the CAN bus).

ID	Parameter	CL	Setting range [Default]	Description
10415	Password basic	1	1 to 9999 [-]	The password for the code level "Basic" is defined in this parameter. Refer to 4.3.4 Enter Password for default values.
10413	Password commissioning	3	1 to 9999 [-]	The password for the code level "Commissioning" is defined in this parameter. Refer to 4.3.4 Enter Password for default values.

ID	Parameter	CL	Setting range [Default]	Description
10414	Code temp. commissioning	3	1 to 9999 [200]	The algorithm for calculating the password for the code level "Temporary Commissioning" is defined in this parameter.
10412	Code temp. super commissioning	5	1 to 9999 [400]	The algorithm for calculating the password for the code level "Temporary Super commissioning" is defined in this parameter.
10411	Password super commissioning	5	1 to 9999 [500]	The password for the code level "Super commissioning" is defined in this parameter. Refer to 4.3.4 Enter Password for default values.
10437	Alphanumeric code temp. comm.	3	(up tp 6 characters) [a9t5]	Alphanumeric code for temporary commissioning level. This is the alphanumeric algorithm value for the formula to reach the temporary commissioning code level (Level 02), entered as string here.
10438	Alphan. code temp. super comm.	5	(up tp 6 characters) [xk38]	Alphanumeric code for temporary super commissioning level This is the alphanumeric algorithm value for the formula to reach the temporary commissioning code level (Level 04), entered as string here.

4.3.4.1.1 Random Number for Password

ID	Parameter	CL	Setting range [Default]	Description
10416	Random number for password		[(random four letters number)]	Random number generated by the easYgen-XT device. Needed to get an alphanumeric password by Woodward support.

4.3.4.1.2 Change/Reset Alphanumeric Password

ID	Parameter	CL	Setting range [Default]	Description
Change password basic level				
10439	Old password basic level	1	((empty))	Enter here your old alphanumeric password to release the password change for the basic code level (CL01)
10440	New password basic level	1	((empty))	Enter here your new alphanumeric password string for the basic code level (CL01)

4 Configuration

4.3.4.1.2 Change/Reset Alphanumeric Password

ID	Parameter	CL	Setting range [Default]	Description
10441	Confirm password basic level	1	((empty))	Repeat here your new alphanumeric password string for the basic code level (CL01)
10442	Change password basic level	1	[No] Yes	<p>With switching this parameter to yes, the control checks the entries for changing the password and executes the password change, if the entries are correct. The visualization 10443 indicates the successful execution.</p> <p>Notes</p> <p>If the parameters 10439, 10440, and 10441 are not correct, the password change is not executed.</p>
10443	Change passw.error basic level	0		Flag: illuminated LED
			[green]	Password was not changed or successfully changed
			red	Error: password could not be changed
10434	Reset password basic level	2	Yes	The control resets the password of the basic level to "CL0001".
			[No]	
Change password commissioning level				
10444	Old password commiss. level	3	((empty))	Enter here your old alphanumeric password to release the password change for the commissioning code level (CL03)
10445	New password commiss. level	3	((empty))	Enter here your new alphanumeric password string for the commissioning code level (CL03)
10446	Confirm password commiss.level	3	((empty))	Repeat here your new alphanumeric password string for the commiss. code level (CL03)
10447	Change password commiss. level	3	[No] Yes	<p>With switching this parameter to »Yes«, the control checks the entries for changing the password and executes the password change, if the entries are correct. The visualization 1048 indicates the successful execution.</p> <p>Notes</p> <p>If the parameters 10444, 10445, and 10446 are not correct, the password change is not executed.</p>
10448	Change passw. error comm.level	0		Flag: illuminated LED
			[green]	Password was not changed or successfully changed
			red	Error: password could not be changed

ID	Parameter	CL	Setting range [Default]	Description
10435	Reset password commiss. level	4	Yes	The control resets the password of the commissioning level to "CL0003".
			[No]	
Change password super commissioning level				
10449	Old passw. super comm. level	5	((empty))	Enter here your old alphanumeric password to release the password change for the super comm. code level (CL05)
10450	New passw. super comm. level	5	((empty))	Enter here your new alphanumeric password string for the super comm. code level (CL05)
10451	Confirm passw.super comm.level	5	((empty))	Repeat here your new alphanumeric password string for the super comm. code level (CL05)
10452	Change passw.super comm. level	5	[No]	With switching this parameter to »Yes«, the control checks the entries for changing the password and executes the password change, if the entries are correct. The visualization 1053 indicates the successful execution.
			Yes	
10453	Change passw. error super comm.level	0		Flag: illuminated LED
			[green]	Password was not changed or successfully changed
			red	Error: password could not be changed
10436	Reset passw. super comm. level	11	Yes	The control resets the password of the commissioning level to "CL0005" e.g., if you forgot your password.
				Notes The code level to execute the password reset is provided by your Woodward sales support partner.
			[No]	

4.3.5 System Management

CAUTION!



Don't initiate »Set factory default settings« during controlling a genset! This causes easYgen rebooting.

Parameter [↩➤ 1701](#) »Set factory default values« causes a reboot of the control. During this time the genset system is not controlled by the easYgen! An uncontrolled operation can lead into life-threatening hazard or damage.

After settings changed: Please wait 30 seconds to be sure changes are saved before power cycling the device.

ID	Parameter	CL	Setting range [Default]	Description
1702	Device number	2	1 to 32 [1] 1 to 31 in GCB/GC mode	<p>A unique address is assigned to the control though this parameter. This unique address permits the controller to be correctly identified on the CAN bus. The address assigned to the controller may only be used once.</p> <p>All other bus addresses are calculated on the number entered in this parameter.</p> <p>The device number is also important for the device assignment in load sharing and load-dependent start/stop.</p> <p>Notes</p> <p>The unit must be rebooted after changing the device number to ensure proper operation.</p> <p>For multiple genset applications please make sure to change parameter ↩➤ 8952 as well. In application mode GCB/GC device number 32 is used by the Group Controller.</p>
1889	Device name preset	2	[Device_name] 12 to 38 characters but varies on font	<p>After set with parameter 1893 this customer specific device name is used e.g. as device name in Ethernet network.</p> <p>Notes</p> <p>Recommended are 19 ASCII characters max. Blanks and special characters will be replaced.</p>
1890	Device name	2	["displayable characters of parameter 1889"] up to 38 characters but varies on font	(Pre)view of device name.

ID	Parameter	CL	Setting range [Default]	Description
1893	Set device name	2	[No]	YES: Device name typed in as value of parameter 1889 taken, processed, and displayable characters saved as parameter 1890.
			Yes	Note Reboot device to apply changed device name on network!
10419	REBOOT	2	[No]	Yes: Reboot will be initiated.
			Yes	Notes Some parameters require a reboot to take effect. Reboot is only possible in operation mode STOP!
10417	Factory default settings	0	Yes	The following three parameters are visible and restoring the configured parameters to factory default values is enabled.
			[No]	The following three parameters are invisible and restoring the configured parameters to factory default values is not enabled.
1701	Set factory default values	4	Yes	All parameters, with the exception of customer defined passwords, will be restored to factory default values. If the default setting is initiated the alarm LED starts twinkling with a higher rate (ca. 5 Hz). Notes The device is power cycled and rebooting after approx. 20 seconds! In case of ToolKit connected via USB service port: USB connection will be lost!
			[No]	All parameters will remain as currently configured.
				Notes This parameter is only displayed, if factory default settings (parameter ↩ 10417) is set to "Yes".
1896	Parameter update rate	4	3 - 7200 s	This parameter defines the time for cyclical saving of changed parameters in the non voluntary memory. (Only accessible in ToolKit.)
			[3 s]	Notes To ensure that parameter changes are saved, wait at least this time after parameter changes before

ID	Parameter	CL	Setting range [Default]	Description
				<p>removing the power supply or reboot.</p> <p>Since memories only allow a limited number of write cycles (about 100000), set this value to a longer time if, for example, you write parameters cyclically via a PLC. Otherwise, the lifetime of the memory is shortened.</p>

4.3.5.1 Reboot Function

The reboot of the device can be initiated by operating a Yes/No switch in ToolKit. This is beneficial because some parameters, like

- 1893 Set device name,
- 3184 Modbus protocol number,
- 15320 Select external terminals and
- 15102 Device type

need a reboot procedure to become effective.



Please be careful with this setting because the device goes off and reboots at new with all its consequences. It's the same like power off/on cycle.

The parameter is located on different ToolKit pages:

- Configure system management
- Modbus protocol
- CANopen
- J1939

4.3.6 Configure Remote Panel Mode

4.3.6.1 Configuration screen Remote Panel Mode

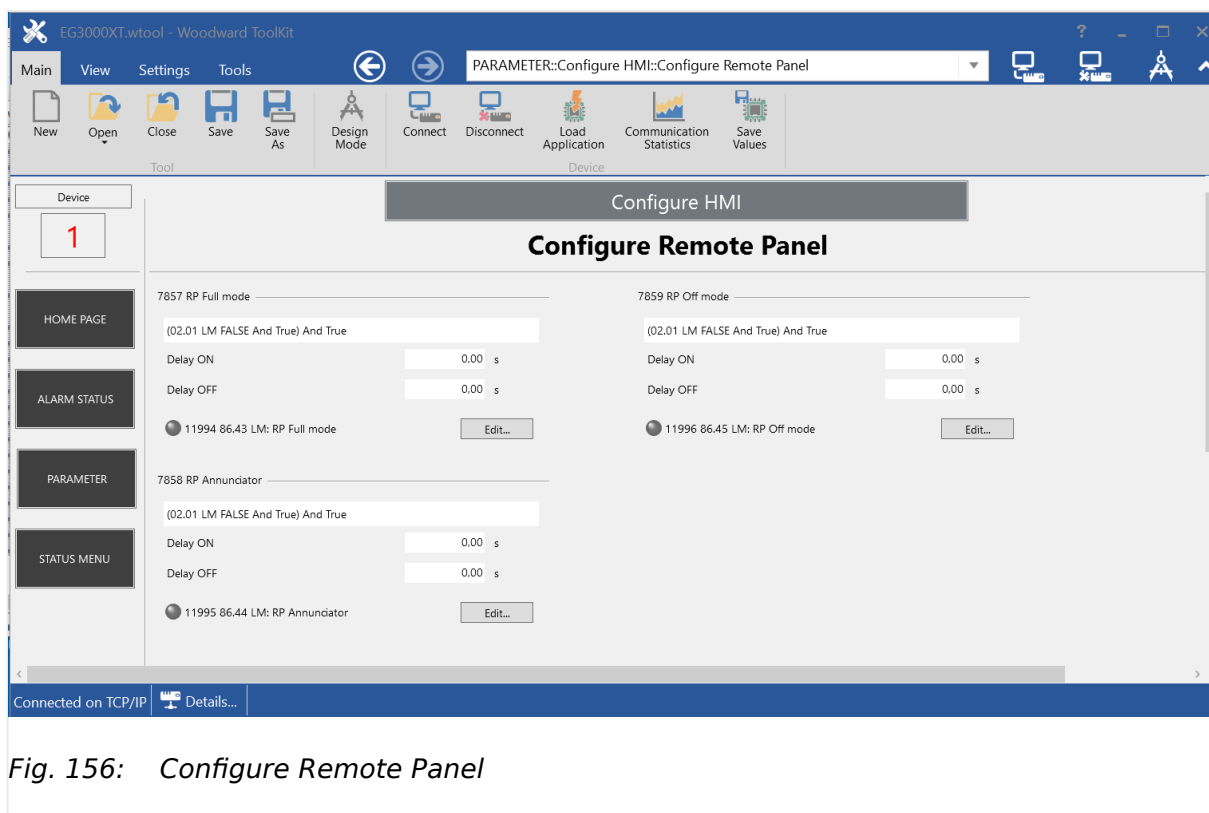

Fig. 156: Configure Remote Panel

4.3.6.2 General notes

General notes

If the remote panel interacts with an easYgen, different use cases could be desired. So the remote panel runs usually without any restrictions, if it is connected with an easYgen-3100XT or easYgen-3400XT. This mode is called Full Access Mode.

But if the remote panel runs with an easYgen-3200XT or easYgen-3500XT, it is not always allowed that both HMI have full control access rights to the genset. Here it is desired to either restrict the control rights for the remote panel (Annunciator Mode) or for the local HMI (Local Keylock). And finally it will be desired to switch off the remote panel completely.

To maintain the different operating modes in the remote panel the easYgen has to determine with LogicsManagers in which operation mode the Remote Panel RP-3000XT shall run. If no LogicsManager is true, full mode with password suppression is active.

Following operation modes are defined (in order of the LogicsManager priority):

- RP-3000XT Full mode with password suppression (no LM true)
- RP-3000XT Full mode
- RP-3000XT Annunciator mode

- RP-3000XT Off mode (highest priority)

4.3.6.3 RP-3000XT in Full Mode with Password suppression

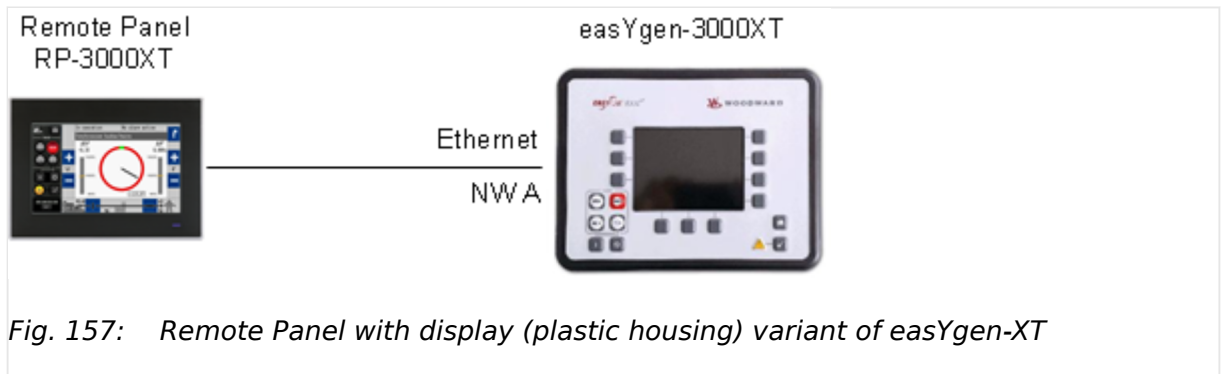

Fig. 157: Remote Panel with display (plastic housing) variant of easYgen-XT

The RP-3000XT represents full the easYgen-3000XT (with Password suppression)

- All Operating Mode buttons are indicated and active
- The MAN Start Stop buttons are indicated and active
- The Acknowledge button is indicated and active
- The Alarm Symbol is indicated and active
- The "Home" button is indicated and active
- The Configuration capability is activated
- No suppress of any screen
- Password Screen is suppressed in the RP, if operated by easYgen-3000XT
- Password entry field of the Password Screen in the easYgen is suppressed, if operated by RP-3000XT

The password suppressed Full Mode becomes active, if there is no mode selected via LogicsManager.

If "Password display" entry field is operated in the RP-3000XT:

- "Password display" entry field in the easYgen is suppressed
- Buttons on the bottom (surrounded by blue dotted line) of the easYgen-3500XT display are blocked
- Button BACK on the upper right is still active (leave password screen)

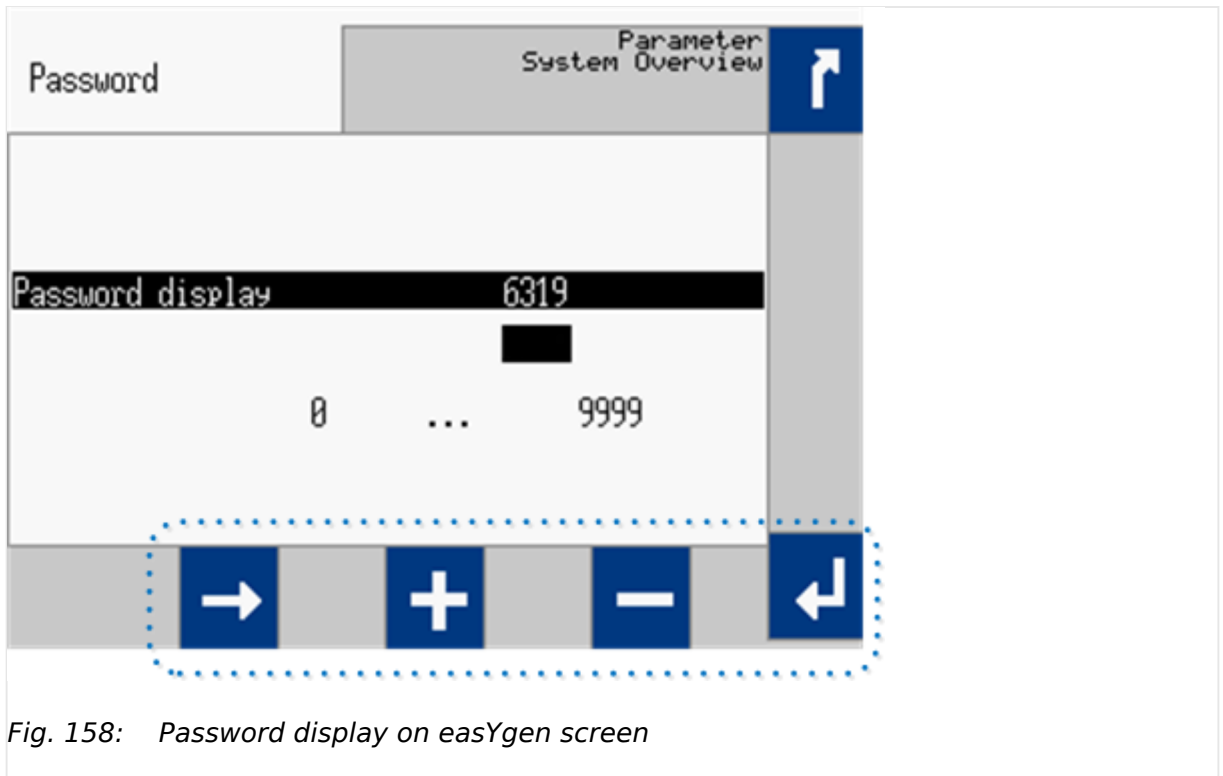

Fig. 158: Password display on easYgen screen

If "Password display" entry field is operated in the easYgen-3000XT:

- Password Screen in the RP-3000XT (VNC viewer) is suppressed
- All buttons of the password screen in the RP-3000XT are blocked

4.3.6.4 RP-3000XT in Full Mode

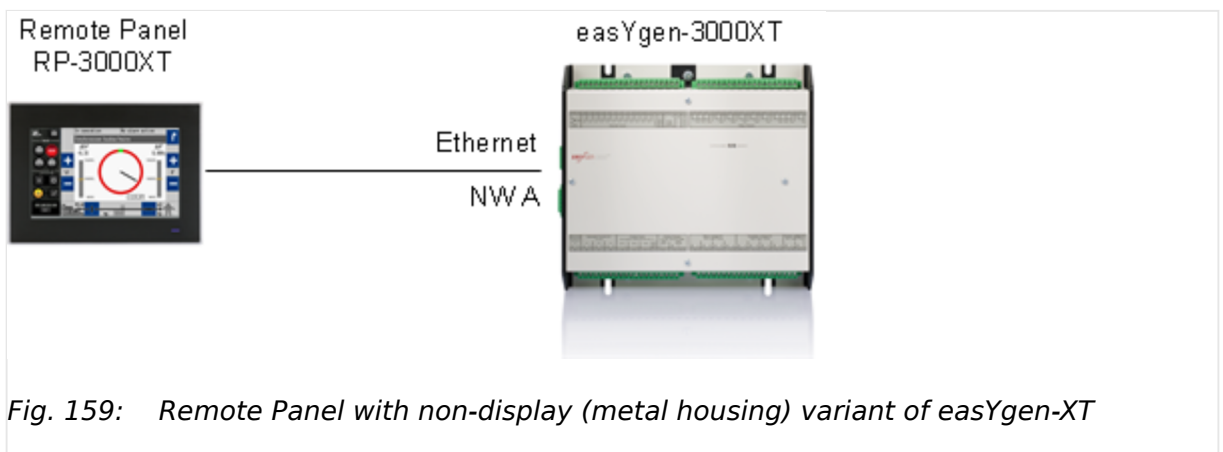

Fig. 159: Remote Panel with non-display (metal housing) variant of easYgen-XT

The RP-3000XT represents full the easYgen-3000XT

- All Operating Mode buttons are indicated and active
- The MAN Start Stop buttons are indicated and active
- The Acknowledge button is indicated and active
- The Alarm Symbol is indicated and active

- The “Home” button is indicated and active
- The Configuration capability is activated
- No suppress of any screen
- No suppress of Password Screen

The Full Mode becomes active, if the easYgen-XT is configured as follows:

- LM "RP-3000XT Full mode" is TRUE
- AND
- LM "RP-3000XT Annunciator mode" is FALSE
- AND
- LM "RP-3000XT Off mode" is FALSE

4.3.6.5 RP-3000XT in Annunciator Mode

The RP-3000XT shows measurement, condition, and alarm data of the easYgen-3000XT. Data in regards to configuration and parameter are faded out and a "disabled" screen (crossed out  Fig. 162) is displayed instead.

- All Operating Mode buttons are not visible, but the current operation is indicated
- The MAN Start/Stop buttons and the breaker soft key buttons are not indicated
- The Acknowledge button is not indicated
- The Alarm Symbol is indicated and active
- The “Home” button is indicated and active
- The Configuration capability is deactivated (according soft key buttons are not indicated or not active)
- All configuration screens of the easYgen are suppressed in the RP-3000XT (disabled screen)

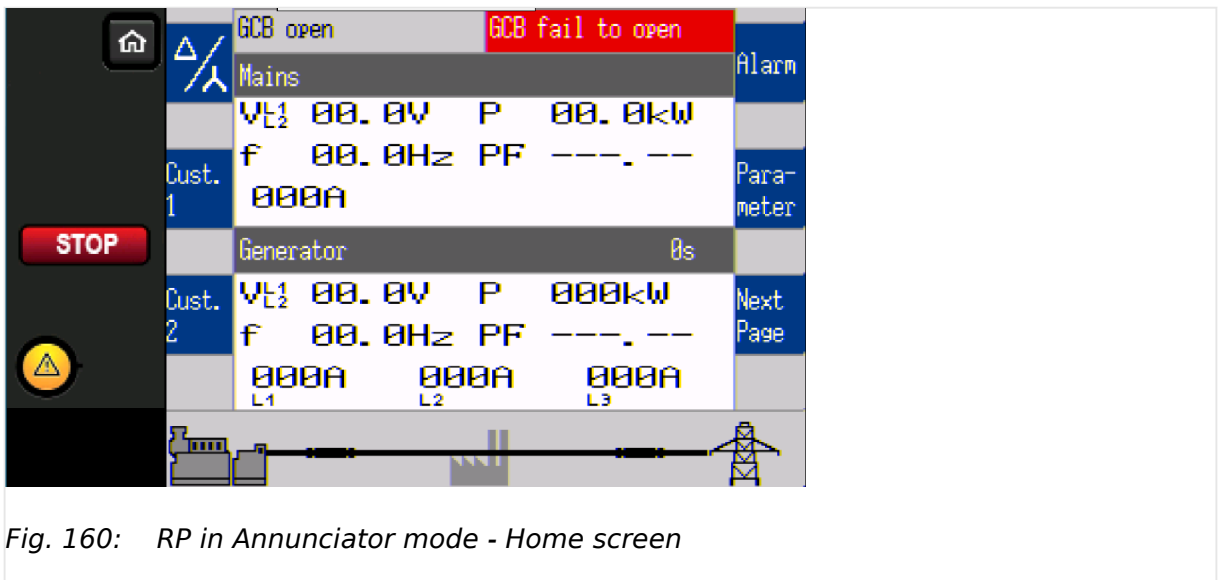

Fig. 160: RP in Annunciator mode - Home screen

The Annunciator mode becomes active, if the easYgen-XT is configured as follows:

- LM "RP-3000XT Annunciator mode" is TRUE
- AND
- LM "RP-3000XT Off mode" is FALSE

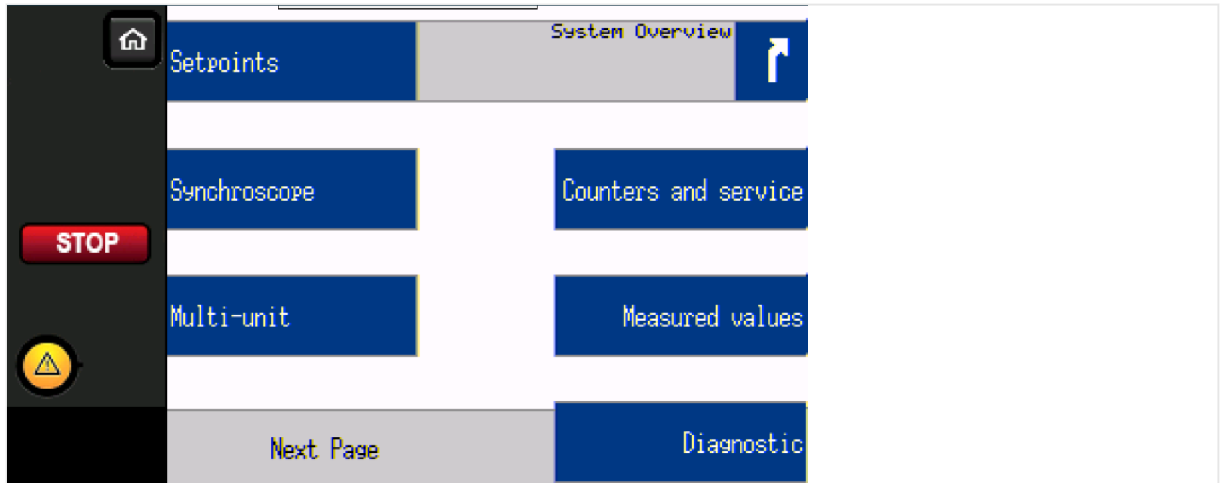

Fig. 161: RP in Annunciator mode - access to menu

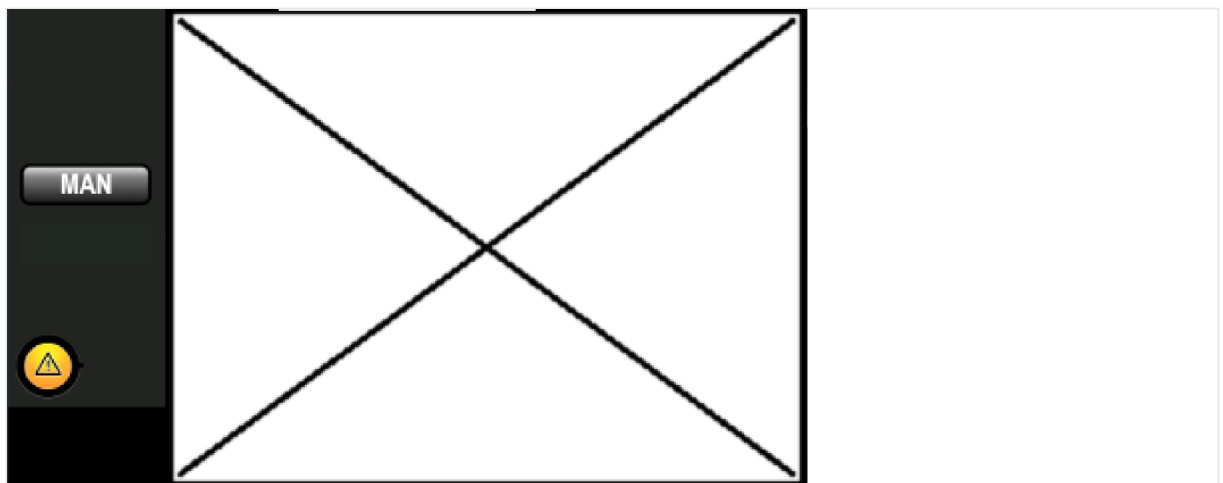

Fig. 162: RP in Annunciator mode - "disabled" screen

4.3.6.6 RP-3000XT in Off Mode

The RP-3000XT supports no screen of the easYgen-3000XT.

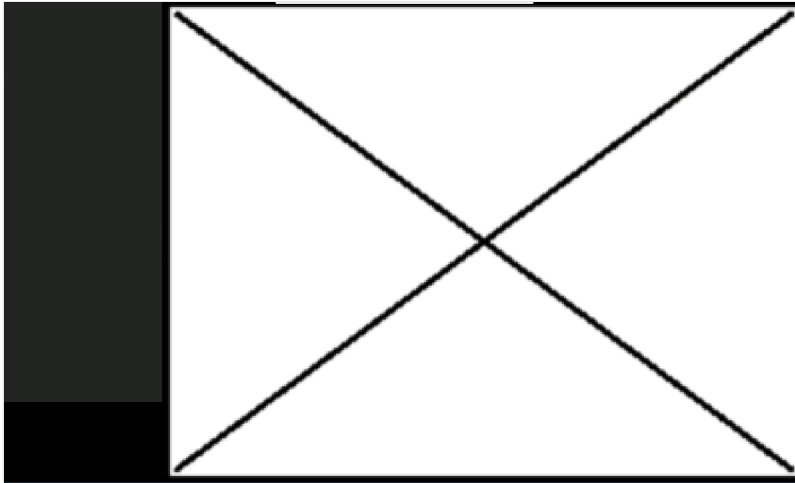

Fig. 163: RP in OFF mode

The Off Mode becomes active, if the easYgen-XT is configured as follows

- LM "RP-3000XT Off mode" is TRUE

4.3.6.7 Parameters of RP Modes



Priority of RP Modes

»RP Off mode« higher than »RP Annunciator« higher than »RP Full mode«.

If no mode is selected via LogicsManager »Full mode with Password suppression« is active!

ID	Parameter	CL	Setting range [Default]	Description
7857	RP Full mode	2	Determined by LogicsManager 86.43 [(02.01 LM FALSE & 02.02 LM TRUE) & 02.02 LM TRUE] = 11994	Once the conditions of the LogicsManager have been fulfilled the unit will empower the RP-3000XT into Full mode described above.
7858	RP Annunciator	2	Determined by LogicsManager 86.44 [(02.01 LM FALSE & 02.02 LM TRUE) & 02.02 LM TRUE] = 11995	Once the conditions of the LogicsManager have been fulfilled the unit will empower the RP-3000XT into Annunciator mode described above.
7859	RP Off mode	2	Determined by LogicsManager 86.45 [(02.01 LM FALSE & 02.02 LM TRUE) & 02.02 LM TRUE]	Once the conditions of the LogicsManager have been fulfilled the unit will downgrade the RP-3000XT to Off mode described above.

ID	Parameter	CL	Setting range [Default]	Description
			= 11996	

4.4 Configure Application

4.4.1 Configure Engine

4.4.1.1 Configure Engine (general)

ID	Parameter	CL	Setting range [Default]	Description
3321	Start/Stop mode logic	2		Diesel or gas engine start/stop logic must be selected.
			[Diesel]	<p>Start sequence</p> <p>The relay "Preglow" will be energized for the preheating time period ("Preglow" is displayed). Following preheating, the fuel solenoid is first energized and then the starter is engaged ("Start" is displayed).</p> <p>When the configured firing speed is exceeded, the starter is disengaged and the fuel solenoid remains energized via the firing speed. "Ramp to rated" is displayed until the engine monitoring delay timer expires and the start sequence has finished.</p> <p>If the engine fails to start, a start pause is initiated ("Start - Pause" is displayed). If the number of unsuccessful start attempts reaches the configured value, an alarm message will be issued ("Start fail" is displayed).</p> <p>Stop sequence</p> <p>After opening the GCB, the coasting time starts and the engine runs without load ("Cool down" is displayed). On termination of the coasting time, the fuel solenoid is de-energized, and the engine is stopped ("Stop engine" is displayed). If the engine cannot be stopped via the fuel solenoid, the alarm message "Eng. stop malfunct." is displayed.</p> <p>Start/stop diagram</p> <p>The formula signs and indices mean:</p>

4 Configuration

4.4.1.1 Configure Engine (general)

ID	Parameter	CL	Setting range [Default]	Description
				<ul style="list-style-type: none"> • tPRE Auxiliary services prerun [s] (parameter ↗ 3300) • tPH Preglow time [s] (parameter ↗ 3308) • tST Starter time [s] (parameter ↗ 3306) • tSP Start pause [s] (parameter ↗ 3307) • tED Engine delayed monitoring [s] (parameter ↗ 3315) • tPOST Auxiliary services postrun [s] (parameter ↗ 3301) • tCD Cool down time [s] (parameter ↗ 3316) • tGS Generator stable time [s] (parameter ↗ 3415) <p>Refer to ↗ "Diesel engine diagrams".</p>
			<p>Gas</p>	<p>Start sequence</p> <p>The starter is engaged ("Turning" is displayed). Following the expiration of the firing delay time and if the engine is rotating with at least the configured "minimum speed for ignition", the ignition is switched on ("Ignition" is displayed).</p> <p>Following the expiration of the gas valve delay, the gas valve is then enabled ("Start" is displayed). If the configured firing speed is exceeded, the starter is disengaged. The gas valve and the ignition remain enabled via the firing speed. "Ramp to rated" is displayed until the engine monitoring delay timer expires and the start sequence has finished.</p> <p>If the configured "minimum speed for ignition" is not reached, a start pause is initiated ("Start - Pause" is displayed) before the next start attempt.</p> <p>Stop sequence</p> <p>After opening the GCB, the coasting time starts and the engine runs without load ("Cool down" is displayed). On termination of the coasting time, the gas valve is closed or de-energized, and the engine is stopped ("Stop engine" is displayed).</p> <p>If the engine cannot be stopped, the alarm message "Eng. stop malfunct." is displayed. If no</p>

ID	Parameter	CL	Setting range [Default]	Description
				<p>speed is detected anymore, the ignition remains active for 5 seconds so that the remaining gas is able to combust.</p> <p>Start/stop diagram</p> <p>The formula signs and indices mean:</p> <ul style="list-style-type: none"> • tPRE Auxiliary services prerun [s] (parameter ↗ 3300) • tST Starter time [s] (parameter ↗ 3306) • tSP Start pause [s] (parameter ↗ 3307) • tID Ignition delay [s] (parameter ↗ 3310) • tGD Gas delay [s] (parameter ↗ 3311) • tED Engine delayed monitoring [s] (parameter ↗ 3315) • tPOST Auxiliary services postrun [s] (parameter ↗ 3301) • tCD Cool down time [s] (parameter ↗ 3316) • tIC Ignition coasting ("post burning") [s] (fixed to 5 seconds) • tGS Generator stable time [s] (parameter ↗ 3415) <p>Refer to ↗ "Gas engine diagrams" and ↗ "Gas engine diagrams".</p> <p>CAUTION</p> <p>It is imperative to connect an emergency stop circuit to discrete input DI 1 to be able to perform an emergency stop by disabling the ignition in case the gas valve fails to close.</p>
			External	The start/stop sequence must be done externally.
			Off	<p>The start/stop sequence is completely disabled.</p> <p>The delayed engine monitoring is dependent from LogicsManager release engine monitoring ↗ 12999.</p> <p>The GCB release is activated by LogicsManager start request in AUTO (parameter ↗ 12120).</p> <p>The controllers are deactivated in operating mode STOP.</p>

4 Configuration

4.4.1.1 Configure Engine (general)

ID	Parameter	CL	Setting range [Default]	Description
				Please refer to ↪ "6.3.13 Start/Stop Logic Mode "Off"" for details.
				Notes All functions which are described here, may be assigned by the LogicsManager to any relay that is available via the LogicsManager and not assigned to another function.
3308	Preglow time (Diesel engine)	2	1 to 999 s [5 s]	Notes The display indicates "Preglow".
3347	Preglow mode (Diesel engine only)	2		This parameter dictates if and under what conditions a diesel engine is preheated.
			Off	The diesel engine is never preheated before a start attempt.
			[Always]	Before a start attempt the "Preheating" relay is always energized for the preglow time (parameter ↪ 3308). After that a start attempt is initiated.
			Analog	A preglow sequence is initiated if the monitored analog input temperature (coolant temperature) is below the configured threshold (parameter ↪ 3309). The preglow sequence is enabled for the configured preglow time (parameter ↪ 3308). After that a start attempt is initiated.
12885	Bypass preglow time (Diesel engine only)	2	Determined by LogicsManager 86.50 [(0 & 1) & 1] = 11558	Once the conditions of the LogicsManager have been fulfilled the diesel engine starts without preglow. Notes This LogicsManager is only used if the "start/stop mode logic" is configured to Diesel in combination with "preglow mode" Always or Analog. An active preglow mode will be interrupted if the LogicsManager becomes active.
3309	Preglow temperature threshold (Diesel engine only)	2	-10 to 250 °C [0 °C]	This is the temperature threshold, which must be exceeded to prevent a preheating process, if parameter ↪ 3347 has been set to "Analog".
3346	AM Preglow criterion (Diesel engine only)	2	Determined by AnalogManager 81.01 [A1 = 10.01 ZERO]	The preglow criterion may be selected from the available data sources.

ID	Parameter	CL	Setting range [Default]	Description
				<p>Usually, a temperature measuring is selected here, which is measured via a sensor.</p> <p>Notes</p> <p>Refer to 4.9.1 Operations for explanation how to use the AnalogManager.</p> <p>Refer to 9.4.2 Data Sources AM for a list of all data sources.</p>
4057	Pre-excitation D+	2	[On]	<p>When the engine is starting up, an exciting current is issued.</p> <p>Notes</p> <p>The resulting voltage at terminal 65 can be monitored. Refer to chapter 4.5.2.7 Engine Charge Alternator (D+) for details.</p>
			Off	<p>No exciting current is issued. The input D+ can be used as analog input which can be configured freely e.g. for (firing) speed detection.</p> <p>Notes</p> <p>This function is only working if the battery voltage is below 27.5 V to avoid overload of internal circuitry.</p>
4058	Pre-excitation D+ off delay	2	0 to 10 s [0 s]	<p>Defines the active (waiting) time of the Analog Output »Pre-excitation D+« after starter time has exceeded.</p> <p>Notes</p> <p>This fallback time of the pre-excitation enables to hold the pre-excitation longer than starter time.</p> <p>Pre-excitation time = Starter time + Pre-excitation D+ off delay time</p>
3310	Ignition delay (Gas Engine only)	2	0 to 9999 s [5 s]	<p>With gas engines often a purging operation is desired before starting.</p> <p>With the engaging of the starter the ignition delay is started. The display indicates "Turning".</p> <p>If the "Minimum speed for ignition" is reached after the expiration of this time, the ignition is energized.</p>
3311	Gas valve delay (Gas Engine only)	2	1 to 999 s [5 s]	<p>By energizing the ignition relay the gas valve delay is started ("Ignition" is displayed).</p>

4 Configuration

4.4.1.1 Configure Engine (general)

ID	Parameter	CL	Setting range [Default]	Description
				<p>After the time set here has expired, and as long as the speed is higher than the minimum speed for ignition, the gas valve is enabled for the time configured in parameter ↩ 3306 "Starter time" ("Start" is displayed).</p> <p>Once the ignition speed has been reached, the gas valve remains opened. If the speed falls below ignition speed, the gas valve will be closed and the "Ignition" relay is de-energized 5 seconds later.</p>
3312	Minimum speed for ignition (Gas Engine only)	2	10 to 1,800 rpm [100 rpm]	After expiration of the ignition delay the number of revolutions set here must be reached, so the "Ignition" relay will be energized.

Diesel engine diagrams

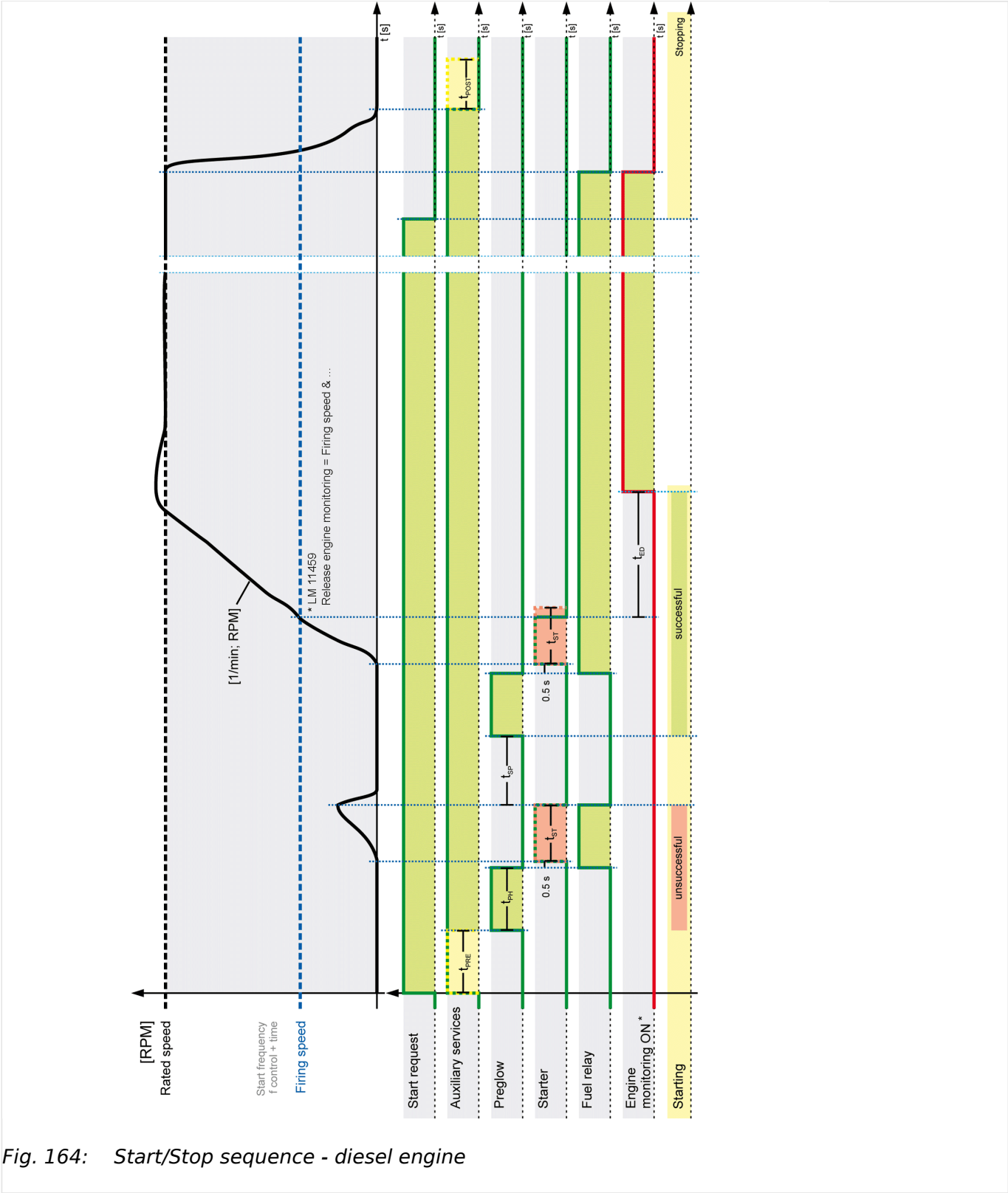

Fig. 164: Start/Stop sequence - diesel engine

Gas engine diagrams

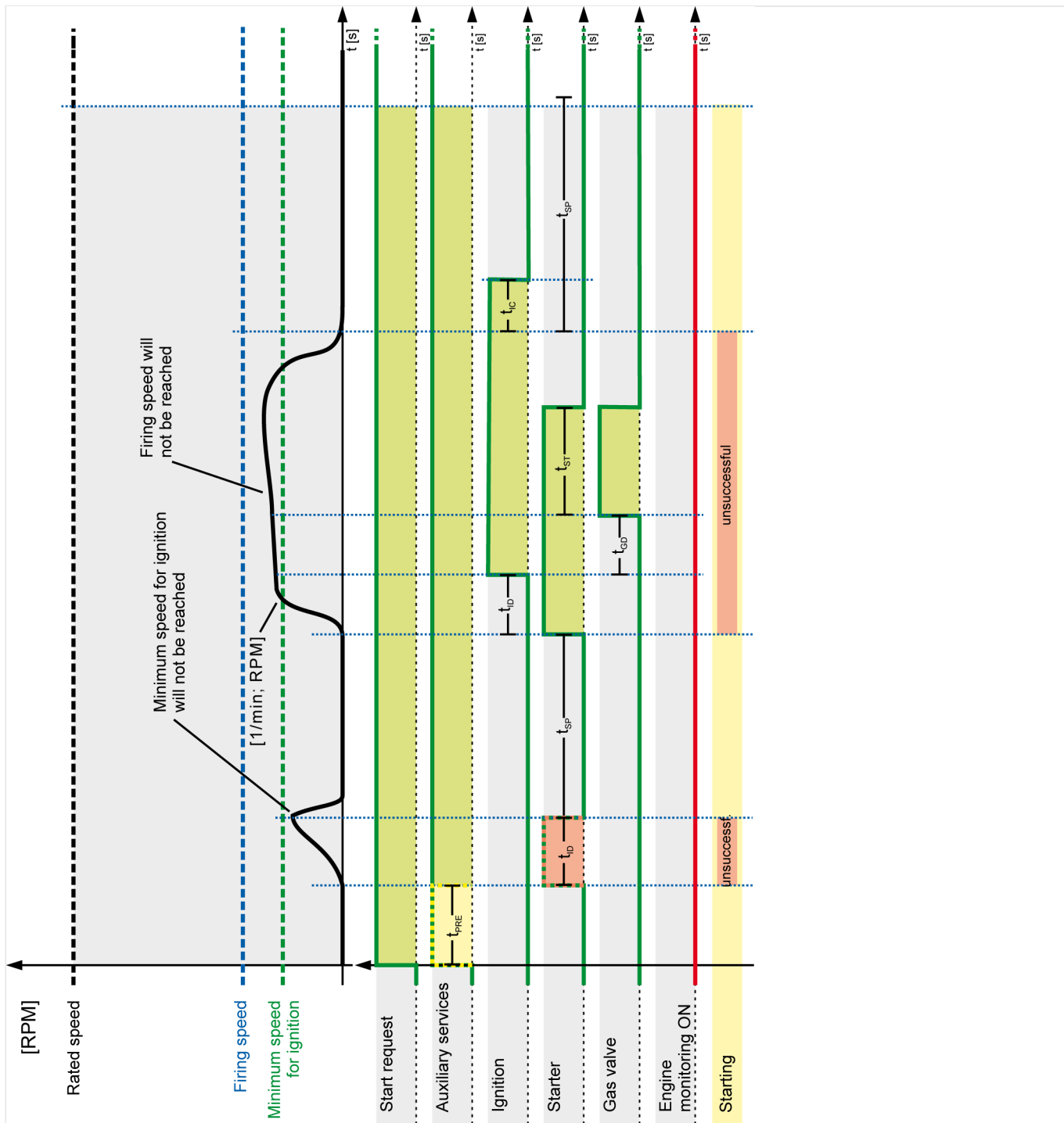

Fig. 165: Start/Stop sequence - gas engine - failure

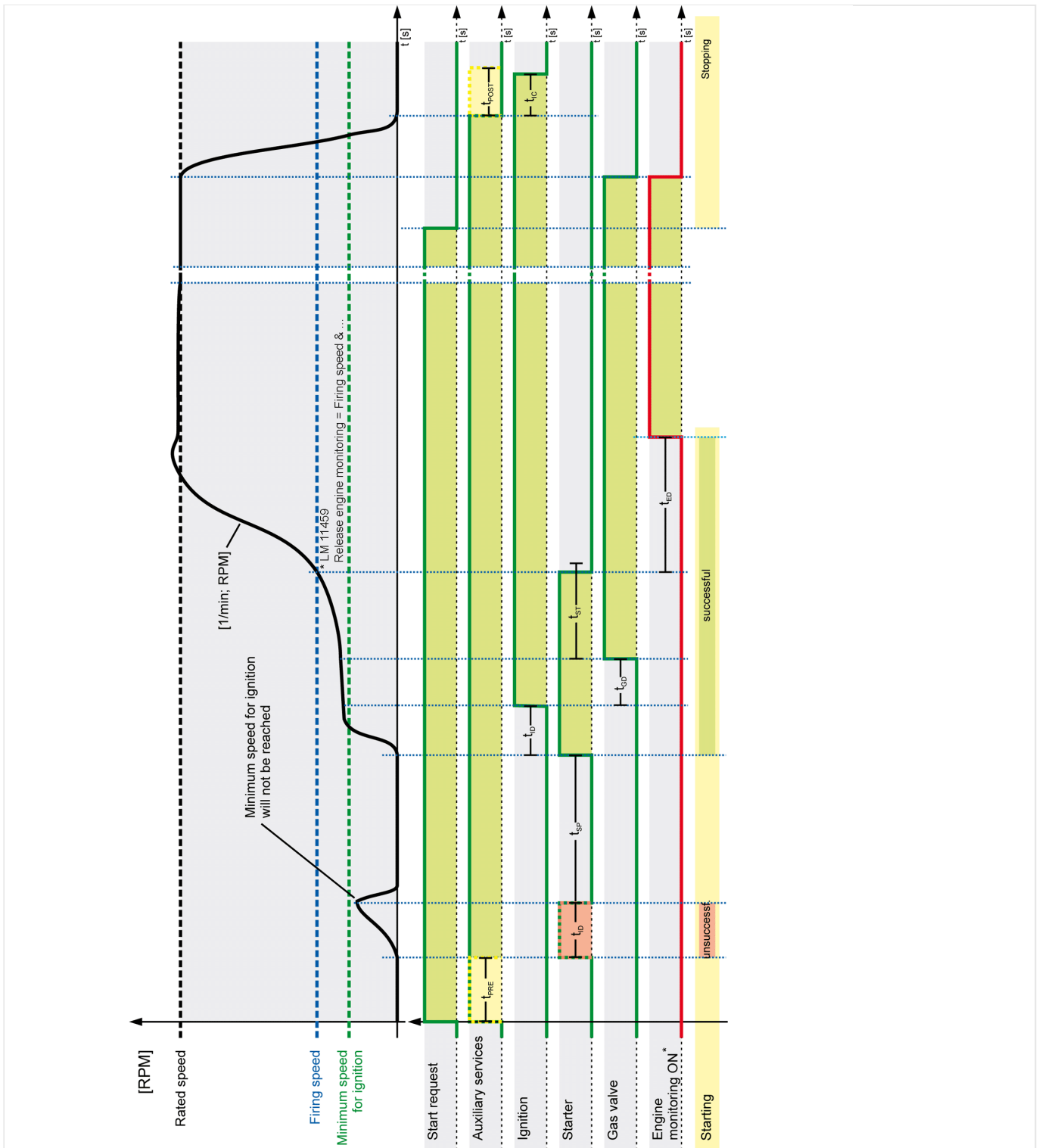

Fig. 166: Start/Stop sequence - gas engine - success

4.4.1.2 Engine Start/Stop

Speed States

Firing speed and the speed detection is now managed by LogicsManager equations named "Firing speed detection" and "Speed detection". The default setting of them is backward compatible!

The possibility to arrange different sources to determine speed and firing speed comes with more flexibility. Woodward recommends to spend some time to understand the parameters and dependencies listed below or on ToolKit page [Parameter / Configuration / Configure application / Configure engine / Configure start/stop].

Firing Speed detection

The “Firing Speed” detection is a basic function of the easYgen genset controls. This information influences a lot of functions and therefore is to configure very carefully!

With the firing speed detection the device recognizes e.g. the engine as successfully started, removes the starter immediately and triggers the timer »Monitoring delay time« for engine speed relevant monitoring. The firing speed can be detected out of different sources.

In comparison to the easYgen-3000 first generation, the firing speed is generated through a LogicsManager equation always and allows all speed source combinations. By default this LogicsManager is configured backward compatible: easYgen-XT behaves like the first generation easYgen-3000.

Speed detection

With the “Speed” detection the device recognizes e.g. the engine as turning or as successful stopped. The speed can be detected out of different sources.

In comparison to the easYgen-3000 first generation, the speed is generated through a LogicsManager equation and allows all speed source combinations. By default the LogicsManager is configured backward compatible: easYgen-XT behaves like the first generation easYgen-3000.

The easYgen provides two LogicsManager command variables (LMCV) for detecting speed:

- Electrical measured determined speed
- Speed sensor (rpm) determined speed

Configuration of the Firing Speed Detection

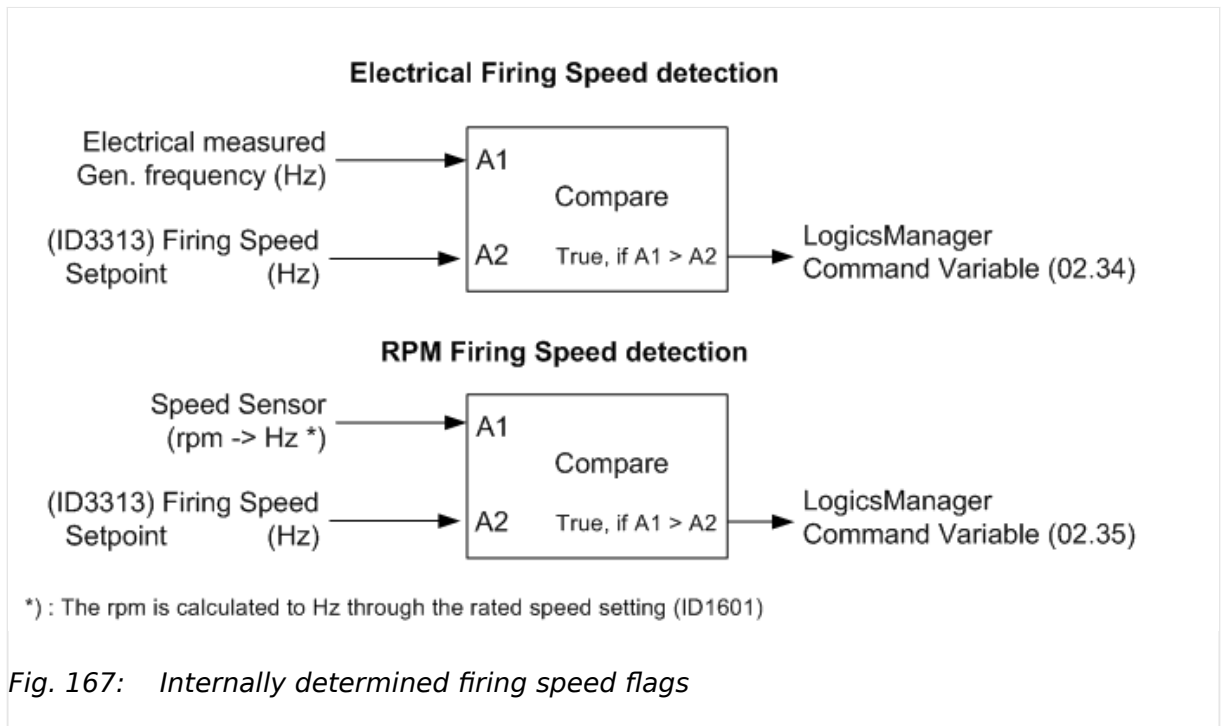

Fig. 167: Internally determined firing speed flags



The electrical frequency measurement starts at 15 Hz. So 15 Hz is usually the lowest firing speed limit. This corresponds for a 4-pole synchronous generator to 450 rpm at 50Hz.

The rpm measurement allows lower firing speed limits. With a speed sensor the firing speed can be configured down to 5 Hz.

✳ **Firing speed configuration**

Configuration A)

- Firing speed: 5 Hz
- Rated speed: 1800 rpm
 Rated frequency: 60Hz

Calculation

- $\text{Firing speed [rpm]} = (\text{Firing speed [Hz]} * \text{Rated speed [rpm]}) / \text{Rated frequency [Hz]}$
- $\text{Firing speed [rpm]} = 5 \text{ Hz} * 1800 \text{ rpm} / 60 \text{ Hz} = 150 \text{ rpm}$

Configuration B

- Firing speed: 5 Hz
- Rated speed: 1500 rpm
 Rated frequency: 50Hz

Calculation

- $\text{Firing speed [rpm]} = (\text{Firing speed [Hz]} * \text{Rated speed [rpm]}) / \text{Rated frequency [Hz]}$
- $\text{Firing speed [rpm]} = 5 \text{ Hz} * 1500 \text{ rpm} / 50 \text{ Hz} = 150 \text{ rpm}$

Usually both command variables 02.34 and 02.35 are entered in the LogicsManager equation for detecting firing speed.

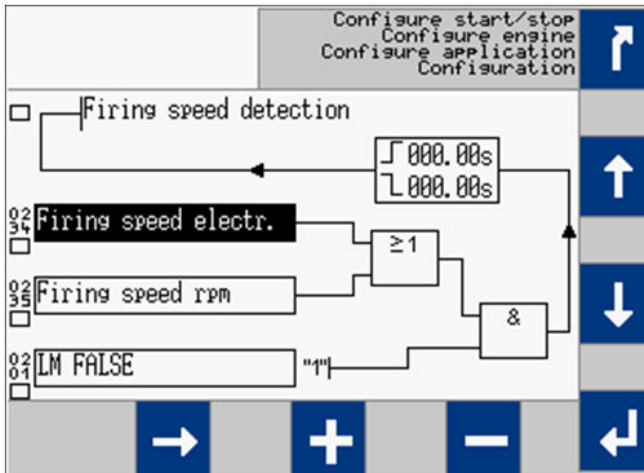
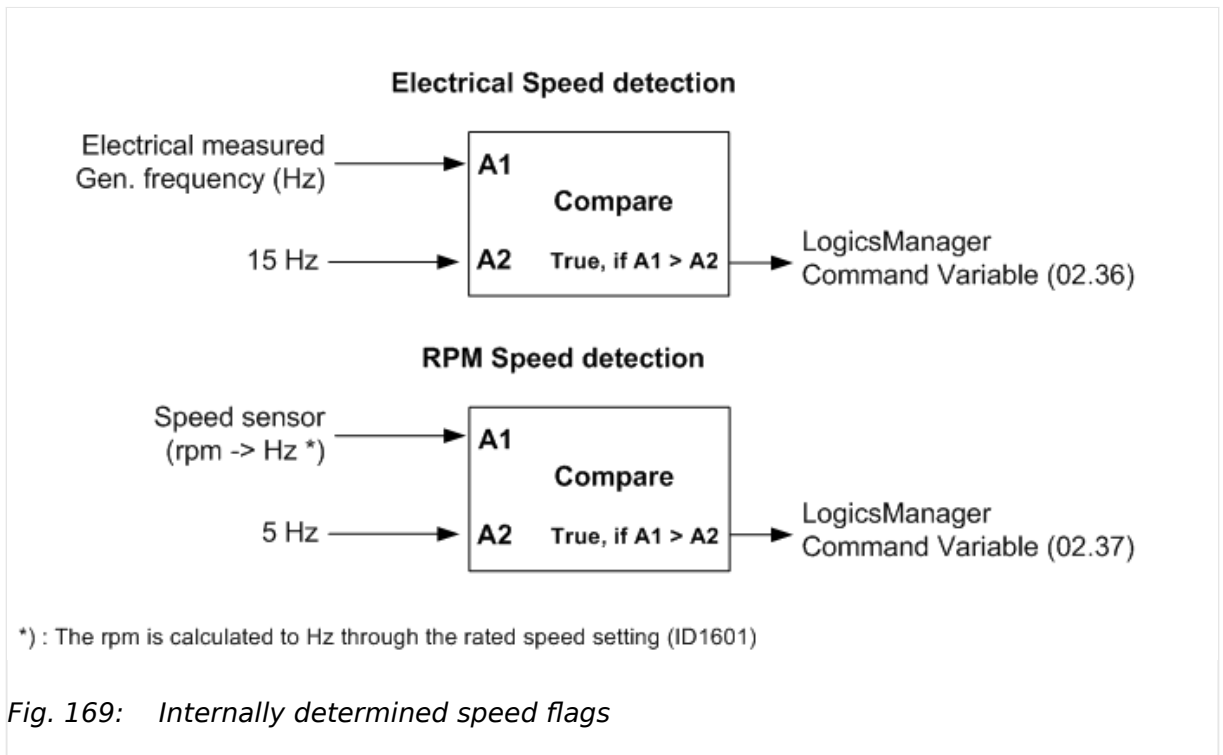

Fig. 168: LogicsManager Firing speed detection

The result of the LM »Firing speed detection« goes directly into the start / stop logic and other functions of the easYgen. Through the LogicsManager approach other sources can be taken into account.

Configuration of the Speed Detection



The electrical frequency measurement starts at 15 Hz. So 15 Hz is usually the lowest speed limit. This corresponds for a 4-pole synchronous generator to 450 rpm at 50Hz.

The rpm measurement allows lower speed limits. With a speed sensor the speed can be configured down to 5 Hz.

Usually both command variables 02.36 and 02.37 are entered in the LogicsManager equation for detecting speed.

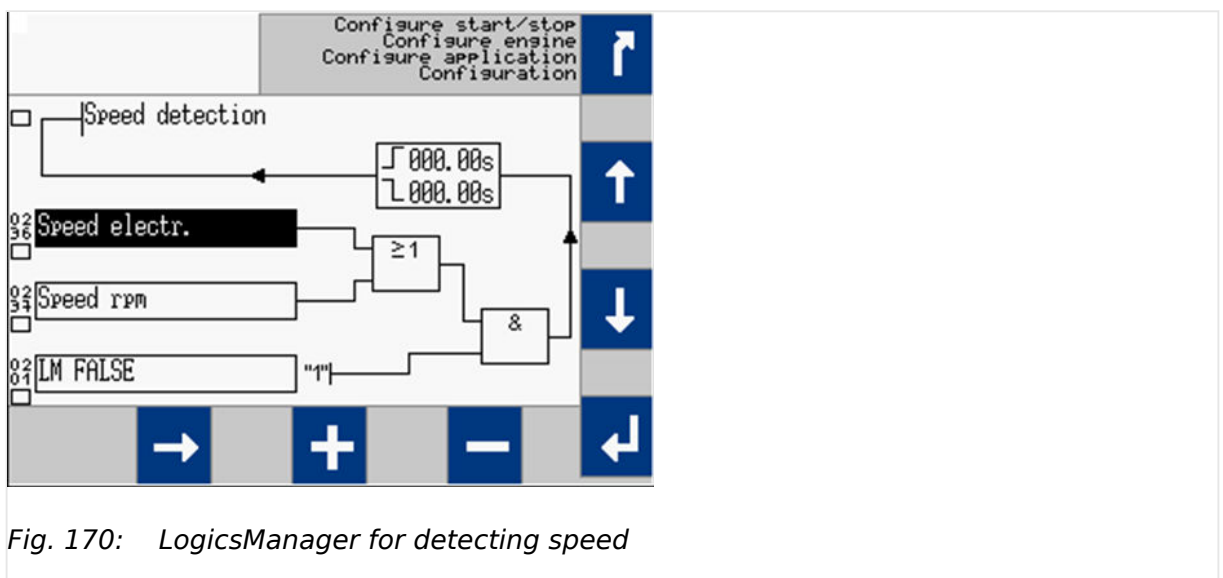

The result of the LM »Speed detection« goes directly into the start / stop logic and other functions of the easYgen. Through the LogicsManager approach other sources can be taken into account.

Firing speed and delayed monitoring



When the firing speed is reached, the starter is disengaged under one of the following conditions:

- The measurement via MPU is enabled (On):
 - Ignition speed measured via MPU is detected or
 - Ignition speed measured via the generator voltage is detected or
 - Ignition speed measured via ECU/J1939 or
 - Conditions for "Ignition speed" (see LogicsManager) equal true.
- The measurement via MPU is disabled (Off):
 - Ignition speed measured via the generator voltage is detected or
 - Conditions for "Ignition speed" (see LogicsManager) equal true.

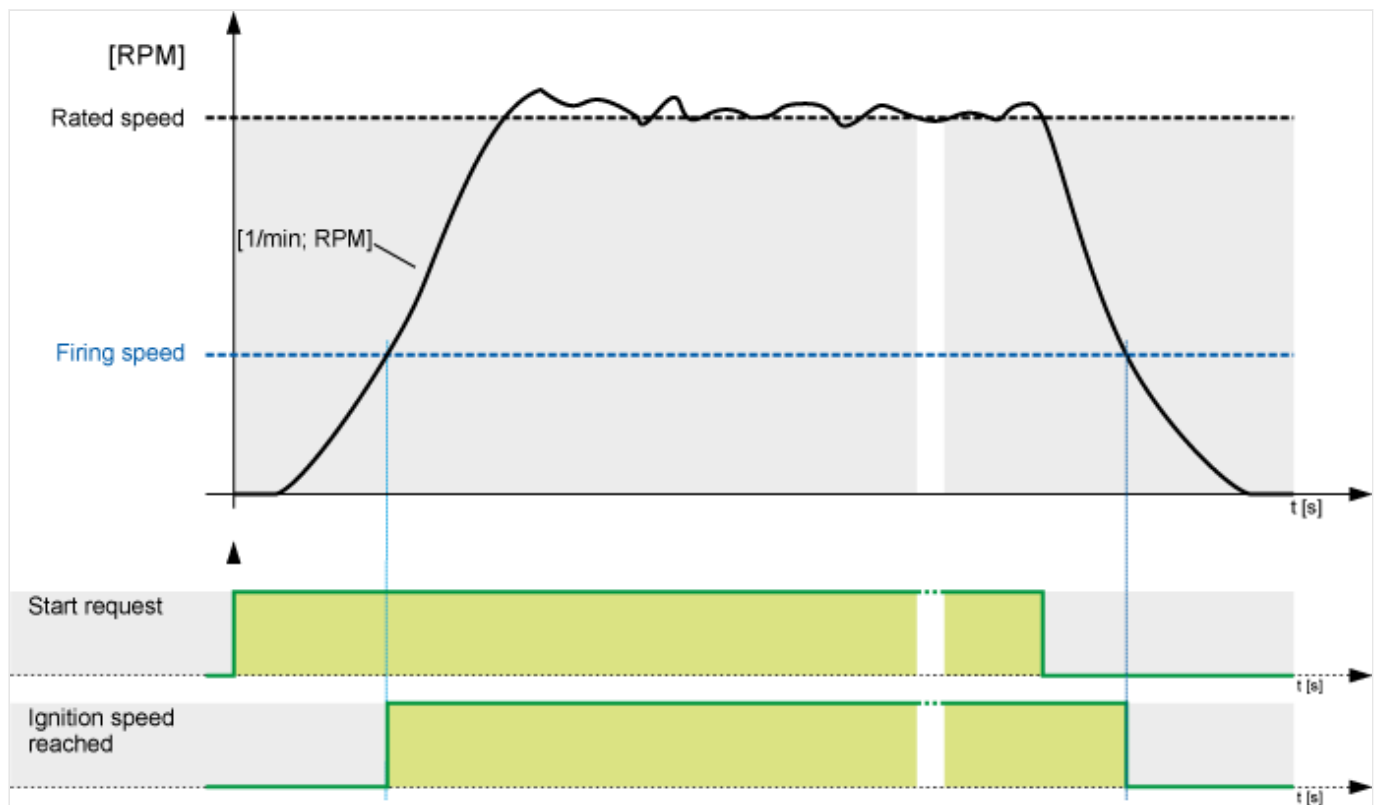

Fig. 171: Engine - firing speed

Auxiliary operations

The auxiliary operations start, as soon as the engine is to be started or a running engine is detected.

At the same time, the discrete output for the auxiliary services (LogicsManager 03.01) will be enabled. This discrete output remains enabled as long as speed is detected or if the controller is in the MANUAL mode.

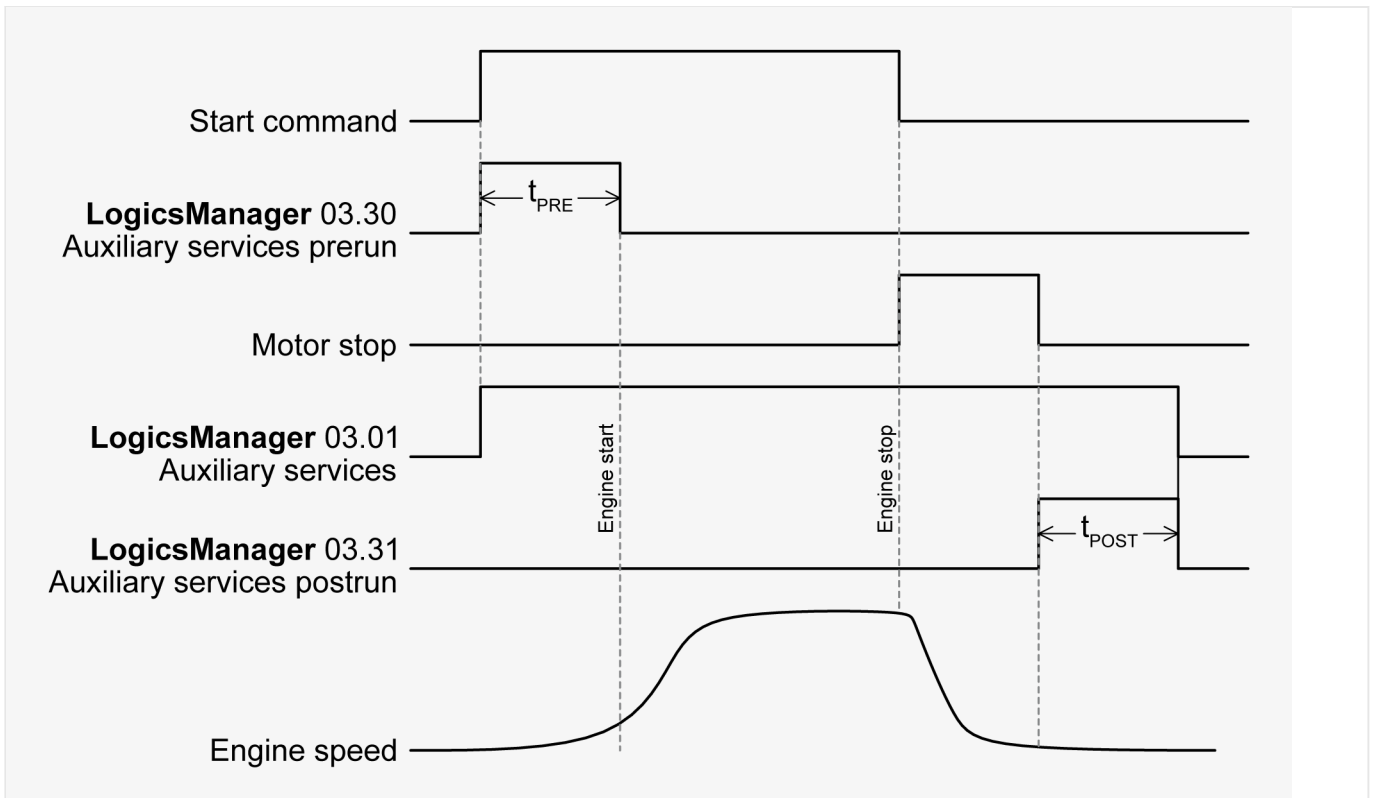

Fig. 172: : Engine - auxiliary services timing

Start/Stop logic (inhibit cranking)

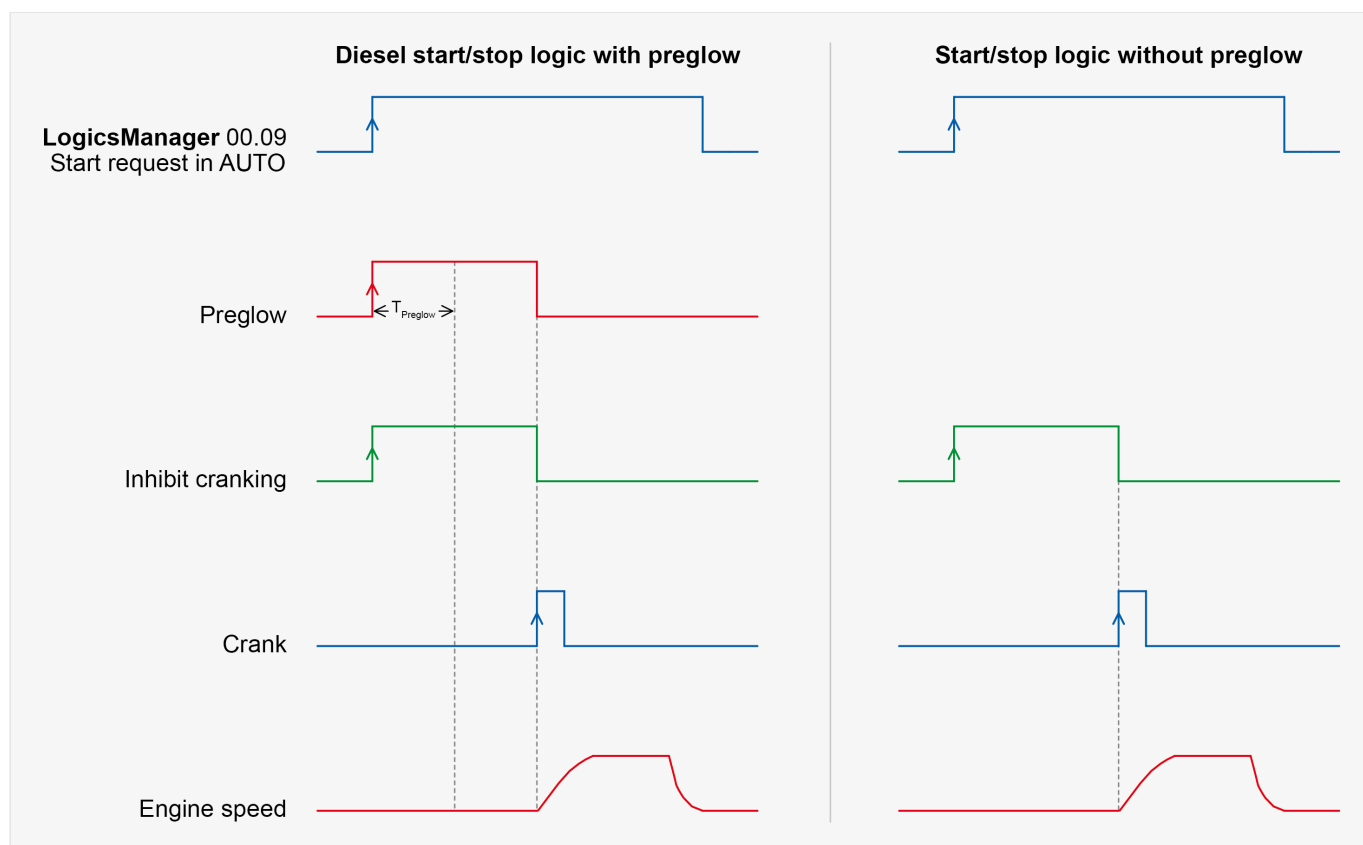



Fig. 173: Engine - start/stop logic (inhibit cranking)

ID	Parameter	CL	Setting range [Default]	Description
3302	Start attempts	2	1 to 20 [3]	<p>The control will attempt to start the engine with this number of start attempts.</p> <p>If the engine fails to start after the configured number of attempts, an alarm will be initiated.</p> <p>An engine has been successfully started if the ignition speed reaches the configured firing speed and the delayed engine monitoring (set by release engine monitoring) has expired.</p>
4102	Start attempts critical mode	2	1 to 20 [10]	<p>If a critical operation mode ( "4.4.6 Emergency Run") is initiated, the engine will continue to attempt to start for the number of starts configured here.</p> <p>An engine has been successfully started if the ignition speed reaches the configured firing speed and the delayed engine monitoring (set by release engine monitoring) has expired.</p>

ID	Parameter	CL	Setting range [Default]	Description
3306	Starter time (Maximum starter delay [t _{ST}])	2	1 to 99 s [5 s]	<p>This is the maximum time that the starter relay will remain energized ("Start" display).</p> <p>If the LogicsManager output "Ignition speed reached" = TRUE, the speed/frequency have reached firing speed, or the time has expired, the relay will be de-energized.</p>
3307	Start pause time	2	1 to 99 s [7 s]	<p>This is the delay time between the individual starting attempts.</p> <p>This time is also used to protect the starter relay. The message "Start - Pause" is displayed.</p>
4844	Inhibit cranking max. time	2	1 to 999 s [60 s]	<p>If the inhibit cranking (parameter ↪ 4871) becomes active this counter starts.</p> <p>Once the counter exceeds the delay time, the message "Start fail" is displayed.</p> <p>The LogicsManager command variable "Inhibit cranking" (03.38) becomes TRUE as soon as the inhibit cranking signal has been issued and remains true until this timer has expired.</p>
3326	Stop time of engine (Engine blocking)	2	1 to 99 s [10 s]	<p>During this time a restart of the engine is blocked. This time should be configured so that the engine is total shutdown to protect the starting circuit.</p> <p>Once speed from the engine is no longer detected the time configured in this parameter is initiated. The message "Stop engine" is displayed.</p> <p>The LogicsManager command variable "Stop solenoid" (03.27) becomes TRUE as soon as the stop signal has been issued and remains true until this timer has expired.</p>
3313	Firing speed	2	5 to 60 Hz [15 Hz]	<p>After firing speed has been reached, the starter is disengaged.</p> <p>The firing speed is to be configured low enough that it is always exceeded during regular generator operation.</p> <p>Notes</p> <p>The time counter for the engine delayed monitoring is no longer activated directly by firing speed but by release engine monitoring ↪ 12999.</p>

4 Configuration

4.4.1.2 Engine Start/Stop

ID	Parameter	CL	Setting range [Default]	Description
				<p>Frequency measurement via the generator voltage input is possible beginning with 15 Hz or higher. If the MPU measurement is enabled, values down to 5 Hz can be measured.</p> <p>With this firing speed limit are generated both the »firing speed electric« flag 02.34 and the »firing speed rpm« flag 02.35.</p>
3315	<p>Engine monitoring delay time</p> <p>(Engine delayed monitoring [t_{ED}])</p>	2	<p>1 to 99 s</p> <p>[8 s]</p>	<p>Delay between LM 12999 "Release eng.mon." becomes TRUE and activation of the monitoring of engine speed delayed alarms (i.e. underspeed).</p> <p>After LM 12999 "Release eng.mon." becomes TRUE, the engine delayed monitoring timer is started.</p> <p>This timer should be configured in such a manner that it corresponds to the starting time of the engine plus any possible startup transients. A GCB closure may take place after the expiration of this timer.</p> <p>Notes</p> <p>The overall time engine monitoring is delayed from firing speed becoming TRUE (former version's setup), Delay On and Delay OFF of LM equation 11459 release engine monitoring must be added.</p> <p>The GCB closure can be initiated prior to engine delayed monitoring by configuring the LogicsManager "Undelay close GCB" (parameter ↩ 12210).</p>
3316	Cool down time	2	<p>1 to 9999 s</p> <p>[180 s]</p>	<p>Regular stop</p> <p>If the engine performs a normal stop (start request is disabled or change into STOP operating mode) or a stop caused by an alarm of alarm class C/D, a cool down with an opened GCB is carried out. This time is programmable. The message "Cool down" is displayed and the LogicsManager command variable 04.10 becomes TRUE.</p> <p>Stop by a class 'C' or 'D' alarm</p> <p>If the engine is stopped by an alarm of this alarm class, a cool down is carried out with an opened GCB. This time is programmable.</p>

ID	Parameter	CL	Setting range [Default]	Description
				<p>Stop by a class 'E' or 'F' alarm</p> <p>If the engine is stopped by an alarm of this alarm class, the engine is shutdown without a cool down immediately.</p> <p>Notes</p> <p>If a critical operation mode (↪ "4.4.6 Emergency Run") is initiated, the time configured in critical mode postrun (parameter 4109) will be used instead of the cool down time.</p>
3319	Cool down in STOP mode	2	[Yes]	A cool down will be performed if the genset is changed to STOP operation mode.
			No	No cool down will be performed if the genset is changed to STOP operation mode.
3322	Cool down without breaker	2		This parameter may be used to perform a cool down if the application mode (parameter ↪ 3444) is configured to "None" or "GCB open".
			Yes	A cool down will be performed if a start signal is disabled or a stop signal is enabled.
			[No]	No cool down will be performed if a start signal is disabled or a stop signal is enabled.
				<p>Notes</p> <p>This parameter only applies to application mode A01 A02.</p>
3300	Auxiliary services prerun (Prerun auxiliary operation (start preparation))	2	0 to 9999 s [0 s]	<p>Prior to a start sequence being initiated, the discrete output for the auxiliary services prerun (LogicsManager 03.30) remains enabled for the configured amount of time to permit engine related operations (i.e. open louvers) to be performed.</p> <p>While this discrete output is enabled the control screen will display the message "Aux.serv.prerun" for the configured time.</p> <p>The auxiliary services discrete output disables when the operation mode is changed from the MANUAL operation mode or, if engine speed is no longer detected, when the discrete output for the auxiliary services postrun (LogicsManager 03.31) is disabled.</p> <p>CAUTION</p>

4 Configuration

4.4.1.2 Engine Start/Stop

ID	Parameter	CL	Setting range [Default]	Description
				During an emergency start this delay time "auxiliary prerun" is not initialized. The engine will be started immediately.
3301	Auxiliary services postrun (Coasting auxiliary operation (post operation))	2	0 to 9999 s [0 s]	<p>After each engine stop (the engine stop timer has expired), the discrete output for the auxiliary services postrun (LogicsManager 03.31) remains energized for an adjustable time (i.e. operate a cooling pump).</p> <p>If the operating mode is changed from MANUAL to STOP or AUTOMATIC without a start command the relay remains energized for this period of time.</p> <p>The message "Aux.serv.postrun" will be displayed on the control unit screen. In the "MANUAL" operating mode this relay output is not used.</p>
4871	Inhibit cranking	2	Determined by LogicsManager 87.66 [(0 & 1) & 1] = 11455	<p>Once the conditions of the LogicsManager have been fulfilled the cranking (03.38) is blocked. The discrete output relay [R 03] will be not energized.</p> <p>Notes</p> <p>For information on the LogicsManager and its default settings see ↗ "9.3.1 LogicsManager Overview".</p> <p>Please refer to ↗ Fig. 173 for details.</p>
12951	Firing speed detection	2	Determined by LogicsManager 87.68 [(02.34 Firing speed electr. OR 02.35 Firing speed rpm) & 1] = 11457	<p>This LogicsManager allows different sources to generate the general firing speed flag. This will be taken into account for the START/STOP automatic and some monitoring functions.</p> <p>Notes</p> <p>The former easYgen was fixed to the electrical frequency always and allowed other sources additionally. The default setting here is backward compatible.</p>
12989	Speed detection	2	Determined by LogicsManager 87.69 [(02.36 Speed electr. OR 02.37 Speed rpm) & 1] = 11458	<p>This LogicsManager allows different sources to generate the general speed flag. This will be taken into account for some monitoring functions.</p> <p>Notes</p> <p>The former easYgen was fixed to the electrical frequency always. The default setting here is backward compatible.</p>

ID	Parameter	CL	Setting range [Default]	Description
12970	MAN engine start	2	Determined by LogicsManager 87.50 [(0 & 1) &1] = 11439	With the rising edge of this LogicsManager equation an engine start command in operating mode MANUAL is initiated. The state TRUE of this LM inhibits the start command in MANUAL.
12971	MAN engine stop	2	Determined by LogicsManager 87.59 [(0 & 1) &1] =11448	With the rising edge of this LogicsManager equation an engine stop command in operating mode MANUAL is initiated. The state TRUE of this LM inhibits the start command in MANUAL.
12999	Release eng.mon.	2	Determined by LogicsManager 87.70 [(02.34 Firing speed electr. & 02.35 Firing speed rpm) & 03.28 Start/Gas] t_{ON} = 0.00; t_{OFF} = 0.00] = 11459	Switch to activate the delayed engine monitoring e.g., oil pressure, under frequency, ... Notes For more details see description below.

Release Engine Monitoring

This LogicsManager equation (ID = 12999 with logical command variable 11459) enables or blocks all monitoring functions, which are speed related by enabled setting: "Delayed by engine speed":

- Under/Over frequency
- Under speed
- Under voltage
- ...

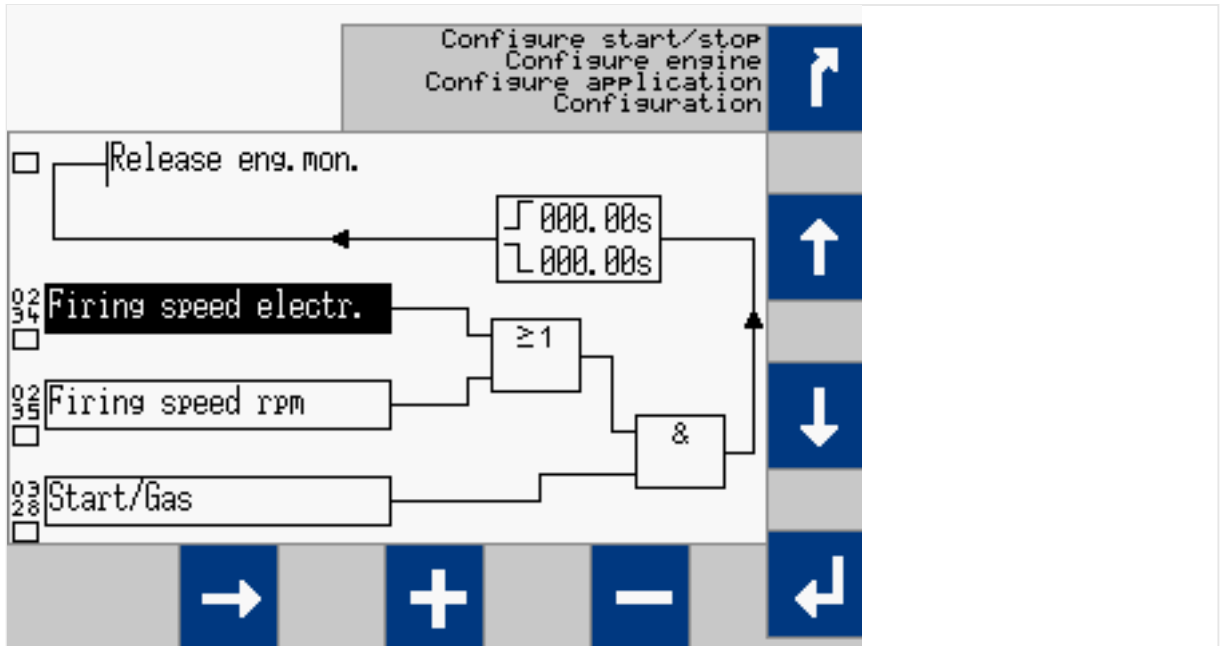



Fig. 174: Release Engine Monitoring screen

In the default setting of the easYgen the engine start/stop is executed by the easYgen directly. So the engine monitoring is released, if the control energizes the solenoid valve (Start/Gas 11657) and the firing speed is reached. In the moment the easYgen removes the solenoid valve the monitoring is disabled. This avoids wrong alarms during the engine stopping procedure.

In cases the start/stop of the drive is executed from outside, the command variable 03.28 Start/Gas (11657) is replaced by a command from outside i.e. any discrete input (09.XX). With starting the drive the operator gives the command for monitoring. With stopping the drive the command has to be removed to avoid wrong alarms during the engine stopping procedure.



The delayed engine monitoring can be seen with the upcoming “Eye” symbol in the single line diagram.

4.4.1.3 Magnetic Pickup Unit

To configure the MPU input, the number of teeth on the flywheel detected by the magnetic pick up (MPU) or the number of pickup pulses per revolution of the engine must be configured.

The table below shows the speed measuring range for various flywheel teeth numbers (parameter ↩ 1602) and rated speeds (parameter ↩ 1601) for a minimum signal voltage of 2 V_{rms}.

Fly wheel teeth	Rated speed [rpm]	Speed measuring range [rpm]
10	1500	1200 to 4500
10	1800	1200 to 5400
10	3000	1200 to 9000
10	3600	1200 to 10800

Fly wheel teeth	Rated speed [rpm]	Speed measuring range [rpm]
25	750	480 to 2250
25	1500	480 to 4500
25	1800	480 to 5400
25	3000	480 to 9000
25	3600	480 to 10800
50	750	240 to 2250
50	1500	240 to 4500
50	1800	240 to 5400
50	3000	240 to 9000
50	3600	240 to 10800
100	750	120 to 2250
100	1500	120 to 4500
100	1800	120 to 5400
100	3000	120 to 6000
100	3600	120 to 6000
150	750	80 to 2250
150	1500	80 to 4000
150	1800	80 to 4000
150	3000	80 to 4000
150	3600	80 to 4000
200	750	60 to 2250
200	1500	60 to 3000
200	1800	60 to 3000
200	3000	60 to 3000
260	750	50 to 2250
260	1500	50 to 2300
260	1800	50 to 2300
280	750	45 to 2100
280	1500	45 to 2100
280	1800	45 to 2100
300	750	40 to 2000
300	1500	40 to 2000
300	1800	40 to 2000
400	750	30 to 1500
400	1500	30 to 1500
500	750	24 to 1200
600	750	20 to 1200
700	750	18 to 850

Fly wheel teeth	Rated speed [rpm]	Speed measuring range [rpm]
800	750	15 to 750

Table 51: MPU input - typical configurations

ID	Parameter	CL	Setting range [Default]	Description
1600	Speed input (Pickup)	2	[On]	Speed monitoring of the engine is carried out by the MPU or via ECU/J1939.
			Off	Speed/frequency monitoring of the generator set (the engine) is performed by measuring the frequency of the generator.
15155	Engine speed source	2	[Internal]	The internal MPU input is used as engine speed source.
			ECU/J1939	An external ECU/J1939 signal is used as speed source.
1602	Fly wheel teeth	2	2 to 800 [118]	Number of pulse per revolution/teeth on the flywheel. Notes This parameter is only applicable if parameter 15155 is set to "Internal".
1605	Speed input filter	2	0 to 9.9 s [0 s]	The PT1-filter for the actual speed value can be configured here. The parameter stands for the 3 times tau value of a PT1 element. That means the configured time defines when 95% of the original value jump is reached. The filtered value is used as input to the controller.
				Notes Input 0.0 s disables the filter influence.

4.4.1.4 Idle Mode

General notes

When the engine is operated at idle speed, undervoltage, underfrequency, and underspeed monitoring as well as the monitoring of the flexible limits 33 through 40 are not performed.

This function allows for a controlled operation of an engine without alarm messages at a lower speed (below the configured underspeed monitoring values) for e.g. a warm-up operation with low emission.

The frequency controller output does not control the idle speed; it will remain in initial state position. The GCB cannot be closed in idle mode.

A message may be output to a relay here using the LogicsManager (Idle mode is active, command variable 04.15), e.g. as a signal for a speed controller. The display indicates "Idle run active" during idle mode.



The idle mode can be **only** used if the function is supported by the ECU or the frequency controller.



The normal operation monitoring limits will be enabled again, if one of the following conditions is fulfilled:

- Idle mode has ended and generator frequency has reached rated frequency -1 Hz. (e.g. 49 Hz at 50 Hz rated)
- Idle mode has ended and engine delayed monitoring (parameter [↩➤ 3315](#)) has expired.



The flexible limits 33 through 40 are disabled during idle mode operation ([↩➤ "4.5.5 Flexible Limits"](#)).

ID	Parameter	CL	Setting range [Default]	Description
12570	Auto idle mode	2	Determined by LogicsManager 86.20 [(0 & 1) ≥ 1 0] = 15719	Once the conditions of the LogicsManager have been fulfilled the engine will be operated in idle mode automatically for the configured time during start-up. Monitoring is limited as described above. This function may always be configured to "1" for example. Notes For information on the LogicsManager and its default settings see ↩➤ "9.3.1 LogicsManager Overview" .
12550	Constant idle run (Continuous idle mode)	2	Determined by LogicsManager 86.14 [(0 & 1) & 0] = 10713	As long as the conditions of the LogicsManager have been fulfilled the engine will be continuously operated in idle mode. Monitoring is limited as described above. A key switch via a DI may be configured here for example. Notes The idle mode is blocked if the GCB is already closed. For information on the LogicsManager and its default settings see ↩➤ "9.3.1 LogicsManager Overview" .
3328	Automatic idle time	2	1 to 9999 s	The automatic idle mode is active for the time configured here.

ID	Parameter	CL	Setting range [Default]	Description
	(Time for automatic idle mode)		[30 s]	Monitoring is limited as described above during this time.
3329	During emergency / critical (Idle mode possible during emergency / critical operation)	2	Yes	If an emergency or critical operation is enabled, the engine will go to rated speed only after completing the configured idle mode.
			[No]	If an emergency or critical operation is enabled, no idle run will be performed. The engine will go directly to rated speed.

4.4.2 Inputs And Outputs

4.4.2.1 Function Of Inputs And Outputs

4.4.2.1.1 Discrete Inputs

The discrete inputs may be grouped into two categories:

- Programmable
 - The discrete input has been assigned a default function using either the LogicsManager or preconfigured alarms such as "emergency stop".
 - The following sections describe how these functions are assigned.
 - The function of a discrete input can be changed if required.
 - The following description of the inputs, labeled with "programmable", refers to the preconfiguration.
- Fixed
 - The discrete input has a specific function that cannot be changed depending upon the configured application mode.

Input	Type/Presets	Description
Discrete input [DI 01]	Programmable Preconfigured to "Emergency STOP"	This discrete input is configured as alarm class F and is not delayed by the engine speed.
Discrete input [DI 02]	Programmable Preconfigured to "Startrequest in AUTO"	Enabled in the AUTOMATIC operation mode This discrete input is configured as a Control input in the alarm class and is not delayed by the engine speed. <ul style="list-style-type: none"> • Energized If the unit is in the AUTOMATIC operation mode (selected with the operating mode selection push button on the front panel) the controlled engine is started automatically. • De-energized

Input	Type/Preset	Description
		The engine is stopped.
Discrete input [DI 03]	Programmable Preconfigured to "Low oil pressure"	This discrete input is configured as alarm class B and is delayed by the engine speed.
Discrete input [DI 04]	Programmable Preconfigured to "Coolant temperature"	This discrete input is configured as alarm class B and is not delayed by the engine speed.
Discrete input [DI 05]	Programmable Preconfigured to "External acknowledgment"	<p>This discrete input is used as a remote acknowledgment for alarms. The input is normally de-energized. When an alarm is to be acknowledged the input is energized. The first time an alarm is acknowledged, the centralized alarm/horn is silenced. When the input is energized a second time, all alarms, which are no longer active, will be acknowledged.</p> <p>This discrete input is configured as a Control input in the alarm class and is not delayed by the engine speed.</p>
Discrete input [DI 06]	Programmable Preconfigured to "Release MCB"	<p>Only applicable for application mode A04</p> <p>This discrete input is configured as a Control input in the alarm class and is not delayed by the engine speed.</p> <ul style="list-style-type: none"> • Energized The MCB is enabled and closure of the breaker is permitted. • De-energized The MCB is not enabled and closure of the breaker is not permitted. This function permits a supervisory control (i.e. a PLC) to allow the closure of the MCB by the genset control.
Discrete input [DI 07]	Fixed to "MCB open reply"	<p>Only applicable for application mode A01 - A06</p> <p>This input implements negative function logic.</p> <p>The controller utilizes the CB auxiliary (B) contacts into this discrete input to reflect the state of the MCB.</p> <p>This discrete input must be energized to show when the breaker is open and de-energized to show when the MCB is closed. The status of the MCB is displayed on the screen.</p> <p>This input is usually used in all breaker modes to change between frequency/voltage and power/power factor control (refer to note below).</p>
Discrete input [DI 08]	Fixed to "GCB open reply"	<p>Only applicable for application modes A03 and A04</p> <p>This input implements negative function logic.</p> <p>The controller utilizes the CB auxiliary (B) contacts into this discrete input to reflect the state of the GCB. This discrete input must be energized to show when the breaker is open and de-energized to show when the GCB is closed. The status of the GCB is displayed on the screen.</p> <p>This input is usually used in all breaker modes to enable reverse power protection, overload MOP protection, mains decoupling and the activation of the load sharing (refer to note below).</p>

Input	Type/Preset	Description
Discrete input [DI 09]	Fixed to "Reply: GGB open" if GGB control is activated	<p>Only applicable for application mode A05, A06 and A09</p> <p>This input implements negative function logic.</p> <p>The controller utilizes the CB auxiliary (B) contacts into this discrete input to reflect the state of the GGB.</p> <p>This discrete input must be energized to show when the breaker is open and de-energized to show when the GGB is closed. The status of the GGB is displayed on the screen.</p> <p>This input is usually used in all breaker modes to change between frequency/voltage and power/power factor control (refer to note below).</p>
Discrete input [DI 10]	<p>Programmable</p> <p>Fixed to "Load busbar is dead" if GGB control is activated</p>	<p>Only applicable for application mode A05, A06 and A09 and ↩ 3441 is set to "On"</p> <p>The controller utilizes an external voltage relay output to reflect the condition of the load busbar. The discrete input must be energized to show the load busbar is dead. The status of the load busbar is displayed on the screen.</p>
Discrete input [DI 11 - DI 23]	<p>Programmable</p> <p>"Discrete Input XX"</p>	<p>Each DI can be separately set-up with description, delay, operation, alarm class, self acknowledgment, and enable.</p>



The genset control usually decides whether it performs voltage and frequency (V/f) control or power and power factor (P/PF) control using the reply of the circuit breakers, i.e. the discrete inputs DI 7 and DI 8.

- If the GCB is open, only V/f control is performed
- If the GCB is closed and the MCB is open, V/f control as well as active and reactive power load sharing is performed
- If the GCB is closed and the MCB is closed, P/PF control or import power control with load sharing and PF control is performed.

A different configuration is possible and depends on the following LogicsManager (parameter [↩ 12940](#) "P control" and parameter [↩ 12941](#) "Q control")



Alarm inputs

All discrete inputs, which are not assigned to a function, can be used as alarm or control inputs. These discrete inputs can be freely configured as such ([↩ "4.4.2.2 Discrete Inputs"](#)).

4.4.2.1.2 Discrete Outputs

- Programmable
 - The discrete output has been assigned a default function using the LogicsManager.
 - The following text describes how these functions are assigned using the LogicsManager.

- It is possible to change the function of the discrete output if required.
- The following description of the outputs, labeled with "programmable", refers to the preconfiguration.
- Fixed
 - The discrete output has a specific function that cannot be changed depending upon the configured application mode.
 - The discrete output cannot be viewed or changed in the LogicsManager.
 - However, the discrete output may be programmable in some application modes.



The discrete outputs can be "programmable" or "fixed" depending on the application mode (parameter [↔ 3444](#)).

For information on the function of the discrete outputs depending on the configured application mode refer to [↔ "4.4.2.3 Discrete Outputs \(LogicsManager\)"](#).

CAUTION!



Uncontrolled operation due to faulty configuration

The discrete output "Ready for operation" must be wired in series with an emergency stop function.

This means that it must be ensured that the generator circuit breaker is opened and the engine is stopped if this discrete output is de-energized.

If the availability of the plant is important, this fault must be signaled independently from the unit.

CAUTION!



Uncontrolled operation due to unknown configuration

The circuit breaker commands must be checked before every commissioning because the relays can be used for different applications and can be assigned to various functions.

- Make sure that all relay outputs are configured correctly.

Output	Type/Preset	Description
Relay output [R 01]	Programmable Fixed to "Ready for operation" CAUTION! Only relay [R 01] has an inverse logic. The relay opens (all other relays close), if the logical output of the LogicsManager becomes TRUE.	This discrete output is used to ensure that the internal functions of the controller are operating properly. It is possible to configure additional events, which cause the contacts of this discrete output to open, using the LogicsManager.
Relay output [R 02]	Programmable	When a centralized alarm is issued, this discrete output is enabled.

4 Configuration

4.4.2.1.2 Discrete Outputs

Output	Type/Preset	Description
	Preconfigured to "Centralized alarm (horn)"	<p>A horn or a buzzer maybe activated via this discrete output. Pressing the button with the "✓" symbol will acknowledge the centralized alarm and disable this discrete output.</p> <p>The discrete output will re-enable if a new fault condition resulting in a centralized alarm occurs. The centralized alarm is initiated by class B alarms or higher.</p>
Relay output [R 03]	Programmable Preconfigured to "Starter"	<p>The generator starting circuit is engaged when this discrete output is enabled.</p> <p>This discrete output will enable depending on the start sequence (refer to the start sequence description in 4.4.1.1 Configure Engine (general)) to energize the starter for the configured starter time (parameter 3306).</p>
Relay output [R 04]	Programmable Preconfigured to "Start/Gas"	<p>Fuel solenoid</p> <p>The fuel solenoid for the diesel engine is energized when this discrete output is enabled. If the engine is given a stop command or engine speed drops below the configured firing speed, this discrete output is disabled immediately.</p> <p>Gas valve</p> <p>The gas valve for the engine is energized when this discrete output is enabled. If the engine is given a stop command or engine speed drops below the configured firing speed, this discrete output is disabled immediately.</p>
Relay output [R 05]	Programmable Preconfigured to "Preglow"	<p>Preglow</p> <p>When this discrete output is enabled, the diesel engine's glow plugs are energized. This function only occurs if the control has been configured for diesel engine start/stop logic.</p> <p>Ignition</p> <p>When this discrete output is enabled, the gas engine's ignition is enabled. This function only occurs if the control has been configured for gas engine start/stop logic.</p> <p>Notes</p> <p>Refer to 4.4.1.1 Configure Engine (general)</p>
Relay output [R 06]	Fixed to "Command: close GCB"	<p>Only applicable for application modes A03 and A04.</p> <p>The "Command: close GCB" output issues the signal for the GCB to close. This relay may be configured as an impulse or steady output signal depending on parameter 3414.</p> <p>Impulse</p> <p>If the output is configured as "Impulse", the discrete output will enable for the time configured in parameter 3416. An external holding coil and sealing contacts must be installed into the GCB closing circuit if this discrete output is configured for an impulse output signal.</p> <p>Steady</p> <p>If the relay is configured as "Steady", the relay will energize and remain enabled as long as the discrete input "Reply GCB" remains de-energized and the generator and busbar voltages are identical. If a class C or higher alarm occurs, this discrete will disable and the GCB will open immediately.</p>

Output	Type/Preset	Description
Relay output [R07]	Fixed to "Command: open GCB"	<p>Not applicable for application mode A01.</p> <p>The parameter ↔ 3403 defines how this relay functions.</p> <ul style="list-style-type: none"> If this output is configured as "N.O.", the relay contacts close resulting in the GCB opening circuit energizing. If this output is configured as "N.C.", the relay contacts open resulting in the GCB opening circuit de-energizing. If this output is configured as "Not used", this relay is freely configurable. The LogicsManager for Relay 7 is preconfigured to "04.70 Opening GCB active" (This pre-configuration is similar to the "N.O." logic). <p>Application mode A02</p> <p>The open GCB command remains enabled until the GCB is manually closed and the discrete input "Reply GCB" is energized. The open GCB command will be issued when a fault condition or an engine shut down occurs.</p> <p>Application mode A03 or A04</p> <p>The controller enables the open GCB command when the GCB is to be opened for switching operations. If the discrete input "Reply GCB" is energized, the open GCB command will be disabled.</p>
Relay output [R08]	Fixed to "Command: close MCB"	<p>Only applicable for application mode A04.</p> <p>The discrete output "Command: close MCB" is an impulse output signal.</p> <p>This discrete output is enabled for the time configured in parameter ↔ 3417.</p> <p>An external holding coil and sealing contacts must be utilized with the MCB closing circuit.</p>
Relay output [R09]	Fixed to "Command: open MCB"	<p>Only applicable for application mode A04.</p> <p>The parameter ↔ 3398 defines how this relay functions.</p> <ul style="list-style-type: none"> If this output is configured as "N.O.", the controller enables this discrete output when the MCB is to be opened for switching operations. If the discrete input "Reply MCB" is energized, the discrete output "Command: open MCB" is disabled. If this output is configured as "Not used", this relay is freely configurable. The LogicsManager for Relay 9 is preconfigured to "04.22 Opening MCB active" (This pre-configuration is similar to the "N.O." logic).
Relay output [R10]	<p>Programmable</p> <p>Fixed to "Command: close GGB" if GGB is activated otherwise preconfigured to "Auxiliary services"</p>	<p>Only applicable for application mode A05, A06 and A09.</p> <p>The discrete output "Command: close GGB" is an impulse output signal.</p> <p>This discrete output is enabled for the time configured in parameter ↔ 5726.</p> <p>An external holding coil and sealing contacts must be utilized with the GGB closing circuit.</p> <p>Preconfiguration "Auxiliary services":</p> <p>The auxiliary services output (LogicsManager 03.01) will be enabled with the start command (prior to the engine start because of the prerun time) and remains enabled as long as the engine is running.</p>

Output	Type/Preset	Description
		<p>It will be disabled after the engine has stopped and the postrun time has expired(i.e. for operating a cooling pump). ↳ “Auxiliary operations” for this behavior.</p> <p>The auxiliary services output (LogicsManager 03.01) is always enabled in MANUAL operation mode.</p>
Relay output [R 11]	Programmable Fixed to"Command: open GGB" if GGB is activated otherwise preconfigured to "Alarm class A and B"	<p>Only applicable for application mode A05, A06 and A09.</p> <p>The parameter ↳ 3471 defines how this relay functions.</p> <ul style="list-style-type: none"> • If this output is configured as "N.O.", the controller enables this discrete output when the GGB is to be opened for switching operations. If the discrete input "Reply GGB" is energized, the discrete output "Command: open GGB" is disabled. • If this output is configured as "Not used", this relay is freely configurable. The LogicsManager configuration "04.25 Opening GGB active" is similar to the "N.O." logic). <p>Preconfiguration "Alarm class A and B":</p> <p>This discrete output is enabled when a warning alarm (class A or B alarm) is issued (↳ “9.5.4 Alarm Classes”).</p> <p>After all warning alarms have been acknowledged, this discrete output will disable.</p>
Relay output [R 12]	Programmable Preconfigured to "Shutdown alarm"	<p>This discrete output is enabled when a shutdown alarm (class C or higher alarm; refer to ↳ “9.5.4 Alarm Classes” for more information) is issued.</p> <p>After all shutdown alarms have been acknowledged, this discrete output will disable.</p>
LogicsManager of DO xx / Relay output [R xx]:		<p>All discrete outputs not assigned to a defined function, may be freely configured via the LogicsManager.</p> <p>Notes</p> <p>[R 13 to 22] are freely configurable via LogicsManager.</p>

4.4.2.2 Discrete Inputs

General notes

Discrete inputs may be configured to normally open (N.O.) or normally closed (N.C.) states.

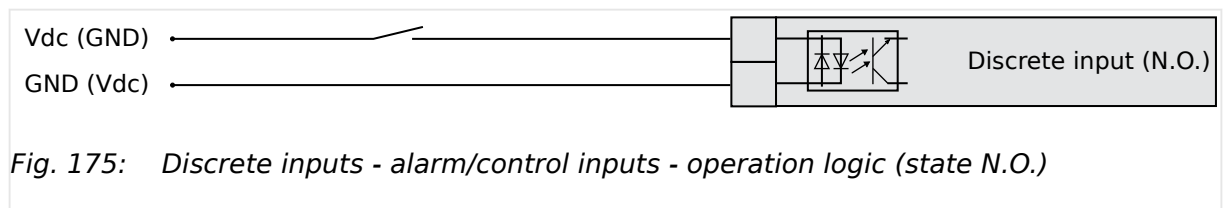

Fig. 175: Discrete inputs - alarm/control inputs - operation logic (state N.O.)

In the state N.O.:

- No potential is present during normal operation.
- If an alarm is issued or control operation is performed, the input is energized.

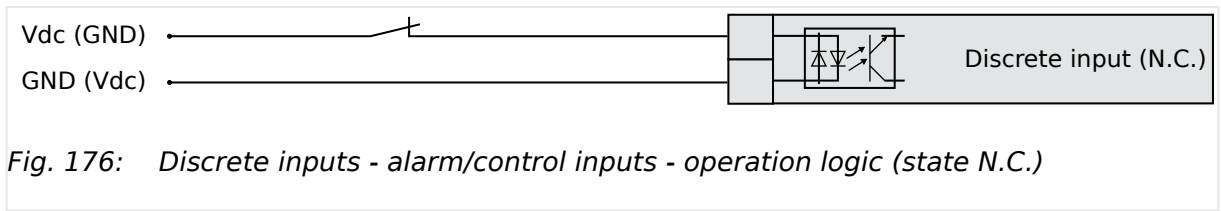

Fig. 176: Discrete inputs - alarm/control inputs - operation logic (state N.C.)

In the state N.C.:

- A potential is continuously present during normal operation
- If an alarm is issued or control operation is performed, the input is de-energized.



All reply messages from breakers are evaluated as N.C.



Alarm inputs may also be configured as control inputs and then be used as command variables in the LogicsManager.



The discrete inputs 1 to 6 are pre-configured to various functions and differ in their default values. However, they may still be configured freely.

The discrete inputs 7 & 8 are always used for the circuit breaker replies and cannot be configured.



If a discrete input has been configured with a shut-down alarm that has been enabled to self-acknowledge, and has been configured as engine delayed the following scenario may happen:

- The discrete input shuts down the engine because of its alarm class.
- Due to the engine stopping, all engine delayed alarms are ignored.
- The alarm class is acknowledged automatically.
- The alarm will self-acknowledge and clear the fault message that shut the engine down.

This prevents the fault from being analyzed.

- After a short delay, the engine will restart.
- After the engine monitoring delay expires, the fault that originally shut down the engine will do so again. This cycle will continue to repeat until corrected.

Internal discrete inputs - terminal assignment

Number	Terminal	Assignment (all application modes)
[DI 01]	67	Pre-configured for Alarm input 'Emergency Stop'
[DI 02]	68	Pre-configured for Control input 'Start request in AUTO'
[DI 03]	69	Pre-configured for Alarm input 'Low oil pressure'

4 Configuration

4.4.2.2 Discrete Inputs

Number	Terminal	Assignment (all application modes)
[DI 04]	70	Pre-configured for Alarm input 'Coolant temperature'
[DI 05]	71	Pre-configured for Control input 'External acknowledgment'
[DI 06]	72	Pre-configured for Control input 'Release MCB'
[DI 07]	73	Fixed to "Reply MCB" if A01 - A06
[DI 08]	74	Fixed to "Reply GCB"
[DI 09]	75	Fixed to "Reply GGB" if A05 , A06 or A09
[DI 10]	76	Fixed to "Voltage monitoring load busbar" if A05 , A06 or A09 and 3441 is set to "On" otherwise Pre-configured for Alarm input
[DI 11]	77	Pre-configured for Alarm input
[DI 12]	78	Pre-configured for Alarm input

Number	Terminal	Assignment (all application modes)
[DI 13]	141	Pre-configured for Alarm input
[DI 14]	142	Pre-configured for Alarm input
[DI 15]	143	Pre-configured for Alarm input
[DI 16]	144	Pre-configured for Alarm input
[DI 17]	145	Pre-configured for Alarm input
[DI 18]	146	Pre-configured for Alarm input
[DI 19]	147	Pre-configured for Alarm input
[DI 20]	148	Pre-configured for Alarm input
[DI 21]	149	Pre-configured for Alarm input
[DI 22]	150	Pre-configured for Alarm input
[DI 23]	151	Pre-configured for Alarm input

Parameter IDs



The following parameters are used to configure the discrete inputs 1 through 12. The parameter IDs refer to discrete input 1.

- Refer to [Table 52](#) for the parameter IDs of the parameters DI 2 through DI 12(23).

	DI 1	DI 2	DI 3	DI 4	DI 5	DI 6	DI 7	DI 8	DI 9	DI 10	DI 11	DI 12
							Reply MCB	Reply GCB	Reply GGB			
Description	1400	1410	1420	1430	1440	1450	1460	1470	1480	1488	1496	1504
Delay	1200	1220	1240	1260	1280	1300	1320		1360	1380	1205	1225
Operation	1201	1221	1241	1261	1281	1301	1321		1361	1381	1206	1226
Alarm class	1202	1222	1242	1262	1282	1302	1322		1362	1382	1207	1227

	DI 1	DI 2	DI 3	DI 4	DI 5	DI 6	DI 7	DI 8	DI 9	DI 10	DI 11	DI 12
							Reply MCB	Reply GCB	Reply GGB			
Self acknowledged	1204	1224	1244	1264	1284	1304	1324		1364	1384	1209	1229
Enabled	1203	1223	1243	1263	1283	1303	1323		1363	1383	1208	1228

Table 52: Discrete inputs - parameter IDs

	DI 13	DI 14	DI 15	DI 16	DI 17	DI 18	DI 19	DI 20	DI 21	DI 22	DI 23
Description	1512	1520	1528	1536	1544	1552	1560	1568	1576	1584	1592
Operation	1246	1266	1286	1306	1326	1346	1366	1386	1211	1231	1251
Delay	1245	1265	1285	1305	1325	1345	1365	1385	1210	1230	1250
Alarm class	1247	1267	1287	1307	1327	1347	1367	1387	1212	1232	1252
Enabled	1248	1268	1288	1308	1328	1348	1368	1388	1213	1233	1253
Self acknowledged	1249	1269	1289	1309	1329	1349	1369	1389	1214	1234	1254

Table 53: Discrete inputs - parameter IDs

ID	Parameter	CL	Setting range [Default]	Description
1400	Description	2	user defined (up to 39 characters) for default see Table	 <p>If the discrete input is enabled with alarm class, this text is displayed on the control unit screen.</p> <p>The event history will store this text message as well.</p> <p>Notes</p> <p>This parameter may only be configured using ToolKit. 19 characters are best for HMI readability - text strings with 20 and more characters but without a blank in between are NOT visible as headline on DI {x} detail screen. DI selection screen on HMI/display works fine with up to 30 characters; others are overwritten by mandatory screen symbols. Please verify the length on the display for best view.</p> <p>If the DI is used as control input with the alarm class "Control", you</p>

4 Configuration

4.4.2.2 Discrete Inputs

ID	Parameter	CL	Setting range [Default]	Description
				may enter here its function (e.g. external acknowledgment) for a better overview within the configuration.
1200	Delay	2	0.08 to 650.00 s [0.20 s]	<p>A delay time in seconds can be assigned to each alarm or control input.</p> <p>The discrete input must be enabled without interruption for the delay time before the unit reacts.</p> <p>If the discrete input is used within the LogicsManager this delay is taken into account as well.</p>
1201	Operation	2		<p>The discrete inputs may be operated by an normally open (N.O.) or normally closed (N.C.) contact.</p> <p>The idle circuit current input can be used to monitor for a wire break.</p> <p>A positive or negative voltage polarity referred to the reference point of the DI may be applied.</p>
			[N.O.]	The discrete input is analyzed as "enabled" by energizing the input (normally open).
			N.C.	The discrete input is analyzed as "enabled" by de-energizing the input (normally closed).
1202	Alarm class	2		<p>An alarm class may be assigned to the discrete input.</p> <p>The alarm class is executed when the discrete input is enabled.</p>
			Class A, [Class B]	Warning alarm classes
			Class C, Class D, Class E, Class F	Shutdown alarm classes
			Control	<p>Signal to issue a control command only.</p> <p>If "control" has been configured, there will be no entry in the event history and a function out of the LogicsManager (↩ "9.3.1 LogicsManager Overview") can be assigned to the discrete input.</p>
1204	Self acknowledge	2	Yes	The control automatically clears the alarm if the fault condition is no longer detected.
			[No]	<p>The control does not automatically reset the alarm when the fault condition is no longer detected.</p> <p>The alarm must be acknowledged and reset by manually pressing</p>

ID	Parameter	CL	Setting range [Default]	Description
				the appropriate buttons or by activating the LogicsManager output "External acknowledgment" (via a discrete input or via an interface).
				Notes If the DI is configured with the alarm class "Control", self acknowledgment is always active.
1203	Enabled	2	[Always]	Monitoring for this fault condition is continuously enabled.
			87.70 LM:Eng.mon	Monitoring for fault conditions is not performed until engine monitoring is enabled. This is determined through the LogicsManager equation "Release engine monitoring".
			For xx = 1 to 32: 96.{xx} LM: Flag{xx}	The monitoring is executed, if the LogicsManager "Flag {xx}" is TRUE. Example: 96.01 LM: Flag 1, 96.02 LM: Flag 2, ..., 96.32 LM: Flag 32

4.4.2.3 Discrete Outputs (LogicsManager)

The discrete outputs are controlled via the LogicsManager.



For information on the LogicsManager and its default settings see [↪ "9.3.1 LogicsManager Overview"](#).

Some outputs are assigned a function according to the application mode (see following table).

Relay		Application mode										
No.	Terminal	None A01	GCB open A02	GCB A03	GCB / MCB A04	GCB / GGB A05	GCB / GGB / MCB A06	GCB / LS5 A07	GCB / L-MCB A08	GCB / GGB / L-MCB A09	GCB / L-GGB A10	GCB / L-GGB / L-MCB A11 and A12, A13
[R 01]	41/42	'Ready for operation'; additionally programmable with LogicsManager CAUTION! Only relay [R 01] has an inverse logic. The relay opens (all other relays close), if the logical output of the LogicsManager becomes TRUE.										
[R 02]	43/46	LogicsManager; pre-assigned with 'Centralized alarm (horn)'										

4 Configuration

4.4.2.3 Discrete Outputs (LogicsManager)

Relay		Application mode										
No.	Terminal	None A01	GCB open A02	GCB A03	GCB / MCB A04	GCB / GGB A05	GCB / GGB / MCB A06	GCB / LS5 A07	GCB / L-MCB A08	GCB / GGB / L-MCB A09	GCB / L-GGB A10	GCB / L- GGB / L-MCB A11 and A12, A13
[R 03]	44/46	LogicsManager; pre-assigned with 'Starter'										
[R 04]	45/46	LogicsManager; pre-assigned with 'Diesel: Fuel solenoid, Gas: Gas valve'										
[R 05]	47/48	LogicsManager; pre-assigned with 'Diesel: Preglow, Gas: Ignition'										
[R 06]	49/50	Logics- Manager		Command: close GCB								
[R 07]	51/52	Logics- Manager		Command: open GCB								
[R 08]	53/54	LogicsManager			Com- mand: close MCB	Logics- Manager		Com- mand: close MCB	LogicsManager			
[R 09]	55/56	LogicsManager; pre- assigned with 'Mains decoupling'			Com- mand: open MCB	Logics- Manager; pre- assigned with 'Mains decoupling'		Com- mand: open MCB	LogicsManager; pre-assigned with 'Mains decoupling'			
[R 10]	57/60	LogicsManager; pre-assigned with 'Auxiliary services'				Command: close GGB		LogicsManager; pre-assigned with 'Auxiliary services'		Com- mand: close GGB	LogicsManager; pre-assigned with 'Auxiliary services'	
[R 11]	58/60	LogicsManager; pre-assigned with 'Alarm class A, B active'				Command: open GGB		LogicsManager; pre-assigned with 'Alarm class A, B active'		Com- mand: open GGB	LogicsManager; pre-assigned with 'Alarm class A, B active'	
[R 12]	59/60	LogicsManager; pre-assigned with 'Alarm class C, D, E, F active'										

Table 54: Internal relay outputs - assignment

R 13 - R 22		
Relay		Configuration
No.	Terminal	
[R 13]	121/122	LogicsManager
[R 14]	123/124	LogicsManager
[R 15]	125/126	LogicsManager
[R 16]	127/128	LogicsManager
[R 17]	129/130	LogicsManager
[R 18]	131/132	LogicsManager
[R 19]	133/134	LogicsManager

R 13 - R 22		
Relay		Configuration
No.	Terminal	
[R 20]	135/136	LogicsManager
[R 21]	137/138	LogicsManager
[R 22]	139/140	LogicsManager

Table 55: Internal relay outputs - assignment

CAUTION!



Uncontrolled operation due to faulty configuration

The discrete output "Ready for operation" must be wired in series with an emergency stop function.

This means that it must be ensured that the generator circuit breaker is opened and the engine is stopped if this discrete output is de-energized.

If the availability of the plant is important, this fault must be signaled independently from the unit.

ID	Parameter	CL	Setting range [Default]	Description
12580	Ready for op. OFF (Ready for operation OFF)	2	Determined by LogicsManager 99.01 [(0 & 0) & 1] = 11870	The "Ready for operation" relay is energized by default if the power supply exceeds 8 V. Once the conditions of the Logics-Manager have been fulfilled, the relay will be de-energized. This LogicsManager output may be configured with additional conditions, which may signal a PLC an "out of operation" condition by de-energizing the relay on terminals 41/42, like "shutdown alarm" or no "AUTO mode" present. Notes For information on the Logics-Manager and its default settings see ↩➤ "9.3.1 LogicsManager Overview" .
12110 (See ID table below)	Relay 2 For (pre-defined) function see assignment table above)	2	Determined by LogicsManager 99.02 [(03.05 Horn & 1) & 1] = 11871	Once the conditions of the Logics-Manager have been fulfilled, the relay will be energized. Notes For information on the Logics-Manager and its default settings see ↩➤ "9.3.1 LogicsManager Overview" .

Parameter IDs

 The parameter IDs above refers to relay 2.

- Refer to [Table 56](#) for the parameter IDs of the parameters for relay 3 to relay 12.

	R 1	R 2	R 3	R 4	R 5	R 6	R 7	R 8	R 9	R 10	R 11	R 12
Parameter ID	12580	12110	12310	12320	12130	12140	12150	12160	12170	12180	12560	12590

Table 56: Discrete outputs - relay parameter IDs

	R 13	R 14	R 15	R 16	R 17	R 18	R 19	R 20	R 21	R 22
Parameter ID	12690	12700	12710	12720	12730	12740	12750	12760	12770	12780

Table 57: Discrete outputs - relay parameter IDs

4.4.2.4 Analog Inputs

4.4.2.4.1 Analog Inputs (general)

4.4.2.4.1.1 Displayed units

 **Conversion restricted to ...**

The conversions described below are only active for parameters »Unit« of

- J1939 pressure and temperature values
- and
- analog inputs which units are configured as »°C« or »bar«.

 **Exact string mandatory**

Type in* the »Unit« string carefully!

For example:

- Temperature works with the exact string»°C« only but not with »°c« or »degC« or »°C« ...
- Pressure needs the exact string »bar« only but don't work with »Bar« or »BAR« ... !

*) Parameters »Unit« are:

AI {x} 1034, 1084, ...; external AI{x} 16208, 16218, ...; PID {x} setpoint 7494, 7495, ...; customer screens {x.y} 7692, 7697, ...

ID	Parameter	CL	Setting range [Default]	Description
3630	Convert bar to psi	1	[No]	The pressure value is displayed in Bar.
			Yes	The pressure value is converted and then displayed in psi.
3631	Convert °C to °F	1	[No]	The temperature is displayed in °C (Celsius).
			Yes	The temperature is displayed in °F (Fahrenheit).

4.4.2.4.1.2 User Defined Tables A/B (Characteristic Curves Setup)

General notes

The characteristic curves of "Table A" and "Table B" (freely configurable over 9 defined points) are independently configurable and can be used among other predefined curves for each of the analog inputs. Each point may be scaled to related values measured from the analog input (0 to 2000 Ohms, 0 to 1 V, or 0 to 20 mA), so that the actual display and monitoring reflects the corresponding values (e.g. 200 to 600 kW).

The created characteristic curves can be used for scaling the analog inputs.

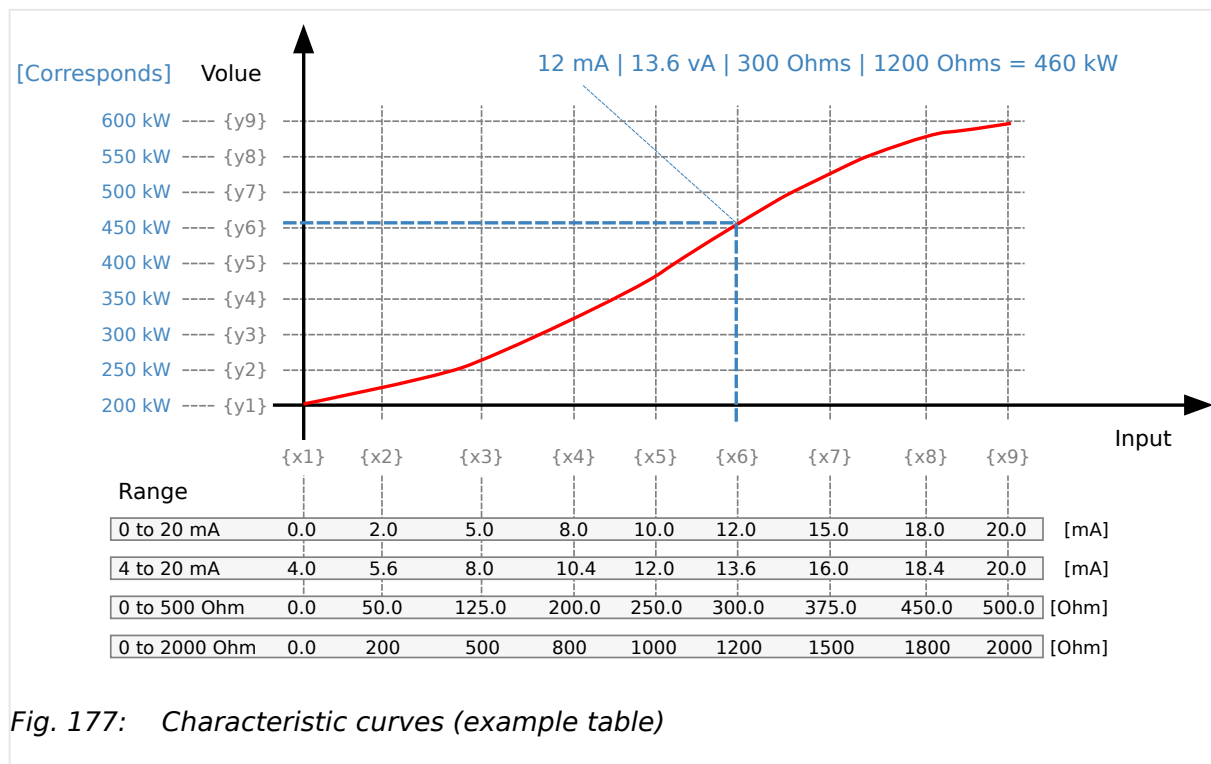

Fig. 177: Characteristic curves (example table)

The X and Y junction may be moved within the range of values and the space between setpoints can be nonuniform.

When configuring the X coordinates, ensure the coordinates always increase in scale continuously.

In the following example the first set of x/y coordinates is correct and the second set of x/y coordinates is wrong:

4 Configuration

4.4.2.4.1.2 User Defined Tables A/B (Characteristic Curves Setup)

(correct)									
X-coordinate	0	200	500	800	1000	1200	1500	1800	2000
Y-coordinate	-100	-95	-50	-10	+3	+17	+18	+100	+2000
wrong:									
X-coordinate	0	200	500	800	400	900	1500	1000	2000
Y-coordinate	-100	-50	-95	+18	+17	+3	-10	+2000	+100



If the first X coordinate is >0, all values smaller than the first X value will be output with the first Y value.

If the last X value is smaller than the maximum of the hardware range, all higher X values will be output with the value of Y9.



All parameters used to configure the characteristic curve follow the samples listed below.

- Refer to [↪ “Parameter IDs and default values for all scaling points”](#) for the parameter IDs of the individual parameters for all scaling points of tables 'A' and 'B'.

Scaling points settings

ID	Parameter	CL	Setting range [Default]	Description
3560 to 3568 or 3610 to 3618	Table {A/B} X-value {1..9}	2	-900000.000 to 900000.000 [0, ... , 20]	The analog input is assigned to a curve. This parameter defines the actual value assigned to each of the nine points along the X-axis of the total range of the selected hardware for analog input. Example If a 0 to 20 mA input is configured and the X1-coordinate = 0, then the value configured for Y1 is output for an input of 0 mA.
3550 to 3558 or 3600 to 3608	Table {A/B} Y-value {1..9}	2	-21000000.00 to 21000000.00 [0, ... , 100]	This parameter defines the Y-coordinate (the displayed and monitored value) at the corresponding X-coordinate. Example If a 0 to 20 mA input is configured and the X2-coordinate = 10, then the value configured for the Y2-coordinate is output for an input of 10 mA.

Parameter IDs and default values for all scaling points

Scaling point no.	1	2	3	4	5	6	7	8	9
Table A - X value	3560	3561	3562	3563	3564	3565	3566	3567	3568
		[2.5]	[5]	[7.5]	[10]	[12.5]	[15]	[17.5]	[20]

Scaling point no.	1	2	3	4	5	6	7	8	9
	[0]								
Table A - Y value	3550	3551	3552	3553	3554	3555	3556	3557	3558
	[0]	[10]	[20]	[30]	[45]	[60]	[70]	[85]	[100]
Table B - X value	3610	3611	3612	3613	3614	3615	3616	3617	3618
	[0]	[2.5]	[5]	[7.5]	[10]	[12.5]	[15]	[17.5]	[20]
Table B - Y value	3600	3601	3602	3603	3604	3605	3606	3607	3608
	[0]	[10]	[20]	[30]	[45]	[60]	[70]	[85]	[100]

4.4.2.4.2 Analog Inputs 1 to 3 (0 to 2000 Ω | 0/4 to 20 m A | 0 to 1 V)**General notes**

Monitoring of the analog inputs (overrun/underrun) must be configured manually to the flexible limits ([↪ "4.5.5 Flexible Limits"](#)).

ID	Parameter	CL	Setting range [Default]	Description
1025 1075 1125	Description	2	user-defined (up to 39 characters) [Analog input {x}]	<p>The event history will store this text message and it is also displayed on the visualization screen.</p> <p>If the programmed limit value of the analog input has been reached or exceeded this text is displayed in the control unit screen.</p> <p>Notes</p> <p>This parameter may only be configured using ToolKit. 19 characters are best for HMI readability - text strings with 20 and more characters but without a blank in between are NOT visible as headline on AI {x} detail screen. AI selection screen on HMI/display works fine with up to 30 characters; others are truncated.</p> <p>The max. number of characters depends on the numbers of Bytes for each character.</p> <p>Please verify the length on the display for best view.</p>
1000 1050	Type	2		According to the following parameters different measuring ranges are possible at the analog inputs.

4 Configuration

4.4.2.4.2 Analog Inputs 1 to 3 (0 to 2000 Ω | 0/4 to 20 m A | 0 to 1 V)

ID	Parameter	CL	Setting range [Default]	Description
1100			[Off]	The analog input is switched off.
			VDO 5bar	The value of the analog input is interpreted with the VDO characteristics 0 to 5 bar.
			VDO 10bar	The value of the analog input is interpreted with the VDO characteristics 0 to 10 bar.
			VDO 150°C	The value of the analog input is interpreted with the VDO characteristics 50 to 150 °C.
			VDO 120°C	The value of the analog input is interpreted with the VDO characteristics 40 to 120 °C.
			Pt100	The value of the analog input is interpreted with a Pt100 characteristic.
			Pt1000	The value of the analog input is interpreted with a Pt1000 characteristic.
			AB 94099	The value of the analog input is interpreted with a AB 94099 characteristic.
			Linear	Each analog input may be assigned to a linear characteristic curve, which can be only used for the respective defined input [T{x}] (x = 1 to 3). The minimum value refers to the value configured as "Sender value at display min." (parameter ↩ 1039, ↩ 1089 or ↩ 1139). The maximum value refers to the value configured as "Sender value at display max." (parameter ↩ 1040, ↩ 1090 or ↩ 1140).
			Table A Table B	The analog input is assigned to a characteristic curve which is defined over 9 points (stored in a table). Two independent tables (table A and table B) may be allocated to the analog inputs.
				<p>Notes</p> <p>Points of these tables must be programmed into the control unit before use.</p> <p>For the characteristic curves of the inputs refer to ↩ "9.1.2 VDO Inputs Characteristics".</p>
1001 1051 1101	<p>User defined min display value</p> <p>(User defined minimum display value)</p>	2	-21000000.00 to 21000000.00 [0.00]	<p>The value (y-axis) to be displayed for the minimum of the input range must be entered here.</p> <p>Notes</p> <p>This parameter is only visible if the parameter "Type" (↩ 1000/</p>

ID	Parameter	CL	Setting range [Default]	Description
				↳ 1050/↳ 1100) is configured to "Linear".
1002 1052 1102	User defined max display value (User defined maximum display value)	2	-21000000.00 to 21000000.00 [2000.00]	The value (y-axis) to be displayed for the maximum of the input range must be entered here. Notes This parameter is only visible if the parameter "Type" (↳ 1000/↳ 1050/↳ 1100) is configured to "Linear".
1039 1089 1139	Sender value at display min. (Sender value at display minimum)	2	0.000 to 2000.000 [0.000]	The value (x-axis) of the configured input range, which shall correspond with the minimum value configured for the display, must be entered here. This specifies the lower limit of the hardware range to be measured. Example If the input range is 0 to 20 mA and the value configured here is 4, an analog input value of 4 mA would correspond with the minimum value configured for the display. Notes This parameter is only visible if the parameter "Type" (↳ 1000/↳ 1050/↳ 1100) is configured to "Linear".
1040 1090 1140	Sender value at display max. (Sender value at display maximum)	2	0.000 to 2000.000 [2000.000]	The value (y-axis) of the configured input range, which shall correspond with the maximum value configured for the display, must be entered here. This specifies the upper limit of the hardware range to be measured. Example If the input range is 0 to 20 mA and the value configured here is 20, an analog input value of 20 mA would correspond with the maximum value configured for the display. Notes This parameter is only visible if the parameter "Type" (↳ 1000/↳ 1050/↳ 1100) is configured to "Linear".

Table 58: Analog Inputs 1 to 3 settings

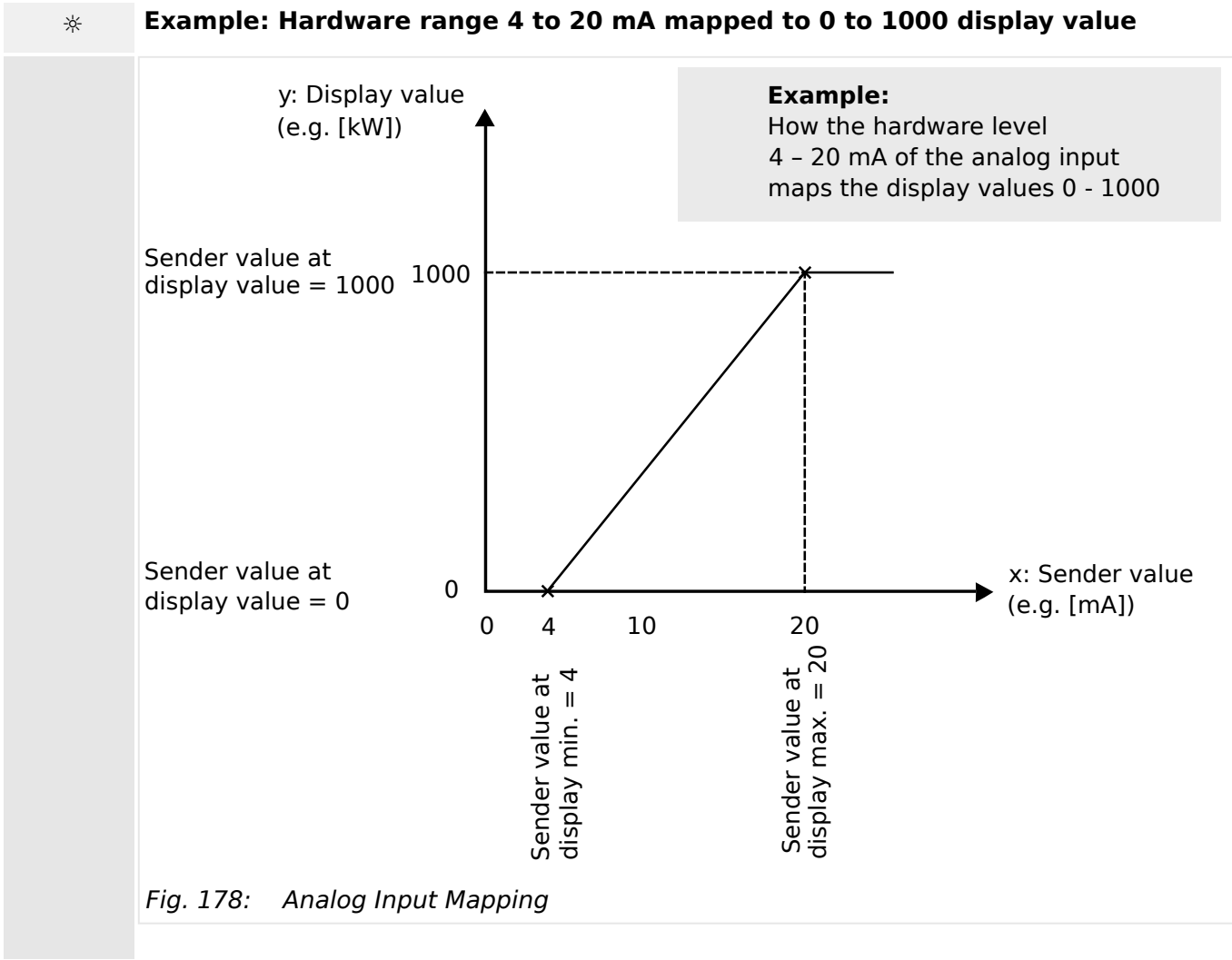

ID	Parameter	CL	Setting range [Default]	Description
1020 1070 1120	Sender type	2	[0 - 2000 Ohm]	The software in the control unit may be configured for various types of sensors. The configurable ranges apply to the linear analog input.
			0 - 20mA	The measuring range of the analog input is 0 to 2000 Ohms.
			0-1V	The measuring range of the analog input is 0/4 to 20 mA.
				The measuring range of the analog input is 0 to 1 V.
				Notes If parameter "Type" (↪ 1000/ ↪ 1050/ ↪ 1100) is set to "VDO xx" or "Pt100", this parameter must be configured to "0 to 2000 Ohm"!
1046 1096	Offset	2	-20.0 to 20.0 Ohms [0.0 Ohm]	The resistive input (the "0 to 2000 Ohms" analog input) may be calculated with a permanent offset to adjust for inaccuracies.

ID	Parameter	CL	Setting range [Default]	Description
1146				<p>If the offset feature is utilized, the value configured in this parameter will be added to/subtracted from the measured resistive value.</p> <p>This has the following effect to the measured values (please note tables in ↩ "9.1.2 VDO Inputs Characteristics"):</p>
				<p>Notes</p> <p>This parameter is only visible if the parameter "Sender type" (↩ 1020/↩ 1070/↩ 1120) is configured to "0 to 2000 Ohms".</p> <p>VDO temperature and pressure senders use the ± range in different ways! Please take care for sender documentation.</p>
1035 1085 1135	Exponent for protocol	2	-2 to 3 [0]	<p>This is the exponent to adapt the decimal place of the actual value (parameter 1033/1083/1133) for the protocol format.</p> <p>Example</p> <p>Exponent is 3:</p> <p>value of analog input $\{ \frac{1}{2} / 3 \} \times 10^3$ = value of analog input $\{ \frac{1}{2} / 3 \} \times 1000$</p>
1033	Analog input 1	(displayed only)		Current scaled value of the AI {X}
1003 1053 1103	Monitoring wire break	2		<p>The respective analog input can be monitored for wire breaks.</p> <p>If this protective function is triggered, the display indicates "Wb: {Text of Parameter [Description]}" (parameter ↩ 1025/↩ 1075/↩ 1125).</p> <p>The following configurations are used to monitor for wire breaks:</p>
			[Off]	No wire break monitoring is performed.
			High	If the actual value rises over the maximum value (overshoot), this is identified as a wire break.
			Low	If the actual value falls below the minimum value (undershoot), this is identified as a wire break.
			High/Low	If the actual value rises over the maximum value (overshoot) or falls below the minimum value (undershoot), this is identified as a wire break.
				<p>Notes</p> <p>Monitoring of the analog inputs (overrun/underrun) must be</p>

4 Configuration

4.4.2.4.2 Analog Inputs 1 to 3 (0 to 2000 Ω | 0/4 to 20 mA | 0 to 1 V)

ID	Parameter	CL	Setting range [Default]	Description
				<p>configured manually to the flexible limits (↩ "4.5.5 Flexible Limits").</p> <p>If the control unit detects that the measuring range for an analog input has been exceeded and an alarm is issued, the limit value monitoring of this analog input is disabled and an error message is displayed.</p> <p>The measuring range is recognized as being exceeded and an alarm is issued:</p> <ul style="list-style-type: none"> 0 to 20 mA: <ul style="list-style-type: none"> Minimum value 2 mA Undershooting Maximum value 20.5 mA Overshooting 0 to 2000 Ohms: <ul style="list-style-type: none"> Minimum value 20 Ohms Undershooting (Offset = 0 Ohm) Maximum value 2040 Ohms Overshooting (Offset = 0 Ohm) 0 to 1 V: <ul style="list-style-type: none"> No wire break monitoring
				<p><i>Resistive sender type only:</i></p> <p>Depending on what was configured for the offset value (parameter ↩ 1046/↩ 1096/↩ 1146) the displayed value may be shifted.</p> <p>This may result in a broken wire being recognized early or later than the actual value being measured. (An offset of +20 Ohms will recognize a wire break at 40 Ohms instead of 20 Ohms.)</p>
				A wire break is indicated in ToolKit by displaying an analog input value "Error".
1004 1054 1104	Wire break alarm class	2		Each limit may be assigned an independent alarm class that specifies what action should be taken when the limit is surpassed.
			Class A, [Class B]	Warning alarm classes
			Class C, Class D, Class E, Class F	Shutdown alarm classes
			Control	Signal to issue a control command only
				Notes

ID	Parameter	CL	Setting range [Default]	Description
				<p>This parameter is only visible if wire break monitoring (parameter 1003/1053/1103) is not set to "Off"</p> <p>For additional information refer to "9.5.4 Alarm Classes".</p>
1005 1055 1105	Self acknowledge wire break	2	Yes	The control automatically clears the alarm if the fault condition is no longer detected.
[No]			The control does not automatically reset the alarm when the fault condition is no longer detected. The alarm must be acknowledged and reset by manually pressing the appropriate buttons or by activating the LogicsManager output "External acknowledgment" (via a discrete input or via an interface).	
			<p>Notes</p> <p>This parameter is only visible wire break monitoring (parameter 1003/1053/1103) is not set to "Off"</p>	
10113 10114 10116	Filter time constant 0/4 to 20 mA and 0 to 1 V	2	Off, 1 to 5	<p>A low pass filter may be used to reduce the fluctuation of an analog input reading.</p> <p>The cut-off-frequency is defined as usual with 63% (e^{-1}).</p>
Off			The analog input is displayed without filtering.	
1			Cut-off-frequency = 7.96 Hz (filter time constant = 0.02 s)	
2			Cut-off-frequency = 3.98 Hz (filter time constant = 0.04 s)	
[3]			Cut-off-frequency = 1.99 Hz (filter time constant = 0.08 s)	
4			Cut-off-frequency = 0.99 Hz (filter time constant = 0.16 s)	
5			Cut-off-frequency = 0.50 Hz (filter time constant = 0.32 s)	
	Filter time constant for 0 to 2000 Ω	2	Off, 1 to 5	<p>A low pass filter may be used to reduce the fluctuation of an analog input reading.</p> <p>The cut-off-frequency is defined as usual with 63% (e^{-1}).</p>
Off			Cut-off-frequency = 0.64 Hz (filter time constant = 0.25 s)	
1			Cut-off-frequency = 0.32 Hz (filter time constant = 0.5 s)	

4 Configuration

4.4.2.4.3 Analog Inputs 4 to 6 (0 to 10 V | 0/4 to 20 mA)

ID	Parameter	CL	Setting range [Default]	Description
			2	Cut-off-frequency = 0.16 Hz (filter time constant = 1.0 s)
			[3]	Cut-off-frequency = 0.08 Hz (filter time constant = 2.0 s)
			4	Cut-off-frequency = 0.04 Hz (filter time constant = 4.0 s)
			5	Cut-off-frequency = 0.02 Hz (filter time constant = 8.0s)
1034 1084 1134	Unit	2	up to 6 characters text [_ _ _ _ _]	<p>This parameter is assigning a unit text to the displayed analog value.</p> <p>Notes</p> <p>This parameter may only be configured using ToolKit.</p> <p>If »°C« or »bar« is assigned the unit will be converted into "F" or "psi" automatically if the corresponding parameter for conversion ↔ 3630 and/or ↔ 3631 is configured to YES.</p> <p>The max. number of characters is 39 but depends on numbers of Bytes for each character. The Bytes/character are defined by the font of the currently selected language.</p> <p> Up to six characters are best for display/HMI; more will override screen border/frame. Please verify the length on the display for best view!</p>
3632 3634 3636	Bargraph minimum	2	-21000000.00 to 21000000.00 [0.00]	The start value for the bar graph display of the analog input is defined here. The value must be entered according to the display format, which refers to the analog input type (parameter ↔ 1000).
3633 3635 3637	Bargraph maximum	2	-21000000.00 to 21000000.00 [2000.00]	The end value for the bar graph display of the analog input is defined here. The value must be entered according to the display format, which refers to the analog input type (parameter ↔ 1000).

Table 59: Analog Inputs 1 to 3 sender settings

4.4.2.4.3 Analog Inputs 4 to 6 (0 to 10 V | 0/4 to 20 mA)

General notes



Monitoring of the analog inputs (overrun/underrun) must be configured manually to the flexible limits ([↔ "4.5.5 Flexible Limits"](#)).

Parameters for configuration

ID	Parameter	CL	Setting range [Default]	Description
7000 7008 7016	Description	2	1 to 16 characters	User-defined text. The event history will store this text message and it is also displayed on the visualization screen.
			[Analog input {x}]	Notes This parameter may only be configured using ToolKit. "x" should be 4 to 6 in accordance with ToolKit and the wiring table.
4310 4321 4332	Type	2		According to the following parameters different measuring ranges are possible at these analog inputs:
			Table A Table B	The analog input is assigned to a characteristic curve which is defined over 9 points (stored in a table). Two independent tables (table A and table B) may be allocated to the analog inputs. Notes Note that if these tables A/B are to be used with the analog inputs, the defined points of these tables must be programmed into the control unit.
			Linear	Each analog input may be assigned to a linear characteristic
			[Off]	The analog input is switched off. Monitoring is disabled.
4311 4322 4333	User defined min display value (User defined minimum display value)	2	-21000000.00 to 21000000.00	The value to be displayed for the minimum of the input range must be entered here.
			[0.00]	Notes This parameter is only visible if the parameter "Type" is configured to "Linear".
4312 4323 4334	User defined max display value (User defined maximum display value)	2	-21000000.00 to 21000000.00	The value to be displayed for the maximum of the input range must be entered here.
			[10.00]	Notes This parameter is only visible if the parameter "Type" is configured to "Linear".
4317 4328	Sender value at display min.	2	0.000 to 20.000	The value of the configured input range, which shall correspond with the minimum value configured for the display, must be entered here. This specifies the lower limit of

4 Configuration

4.4.2.4.3 Analog Inputs 4 to 6 (0 to 10 V | 0/4 to 20 mA)

ID	Parameter	CL	Setting range [Default]	Description
4339	(Sender value at display minimum)			<p>the hardware range to be measured.</p> <p>Example</p> <p>If the input range is 0 to 20 mA and the value configured here is 6, an analog input value of 6 mA would correspond with the minimum value configured for the display.</p>
			[0.000]	<p>Notes</p> <p>This parameter is only visible if the parameter "Type" is configured to "Linear", "Table A", or "Table B".</p>
4318 4329 4340	Sender value at display max. (Sender value at display maximum)	2	0.000 to 20.000	<p>The value of the configured input range, which shall correspond with the maximum value configured for the display, must be entered here. This specifies the upper limit of the hardware range to be measured.</p> <p>Example</p> <p>If the input range is 0 to 10 V and the value configured here is 3.6, an analog input value of 3.6 V would correspond with the maximum value configured for the display.</p>
			[10.000]	<p>Notes</p> <p>This parameter is only visible if the parameter "Type" is configured to "Linear", "Table A", or "Table B".</p>
4316 4327 4338	Sender type	2	<ul style="list-style-type: none"> • 0 - 20mA • 0 - 10V 	<p>The software in the control unit may be configured for various types of sensors. The configurable ranges apply to the linear analog input.</p> <p>0 to 10 V:</p> <p>The measuring range of the analog input is 0 to 10 Volt.</p> <p>0 to 20 mA:</p> <p>The measuring range of the analog input is 0 to 20 mA.</p>
			[0 - 10V]	<p>Notes</p> <p>The "0 to 20 mA" input requires a bridge at the according terminals. Refer to connection set up.</p>
4313 4324	Monitoring wire break	2		<p>The respective analog input can be monitored for wire breaks. If this protective function is</p>

ID	Parameter	CL	Setting range [Default]	Description
4335			<p>High</p> <p>Low</p> <p>High/Low</p> <p>[Off]</p>	<p>triggered, the display indicates "Wb: {Text of Parameter [Description]}".</p> <p>The following configurations are used to monitor for wire breaks:</p> <p>If the actual value rises over the maximum value (overshoot), this is identified as a wire break.</p> <p>If the actual value falls below the minimum value (undershoot), this is identified as a wire break.</p> <p>If the actual value rises over the maximum value (overshoot) or falls below the minimum value (undershoot), this is identified as a wire break.</p> <p>No wire break monitoring is performed.</p> <p>Notes</p> <p>Monitoring of the analog inputs (overrun/underrun) must be configured manually to the flexible limits (refer to chapter 4.5.5 Flexible Limits).</p> <p>If the control unit detects that the measuring range for an analog input has been exceeded and an alarm is issued, the limit value monitoring of this analog input is disabled and an error message is displayed. The measuring range is recognized as being exceeded and an alarm is issued:</p> <p>4 to 20 mA:</p> <p>Minimum value 2 mA Undershooting</p> <p>Maximum value 20.5 mA Overshooting</p> <p>0 to 10 V:</p> <p>No wire break detection / monitoring.</p>
4314 4325 4336	Wire break alarm class	2	Class A, Class B, Class C, Class D, Class E, Class F , Control	<p>Each limit may be assigned an independent alarm class that specifies what action should be taken when the limit is surpassed.</p> <p>Class A / Class B Warning alarm classes.</p> <p>Class C / Class D / Class E / Class F Shutdown alarm classes.</p> <p>Control to issue a control command only.</p>

4 Configuration

4.4.2.4.3 Analog Inputs 4 to 6 (0 to 10 V | 0/4 to 20 mA)

ID	Parameter	CL	Setting range [Default]	Description
			[Class B]	Notes This parameter is only visible, if wire break monitoring is not set to "Off".
4315 4326 4337	Self acknowledge wire break	2	Yes, No	Yes: The control automatically clears the alarm if the fault condition is no longer detected. No: The control does not automatically reset the alarm when the fault condition is no longer detected. The alarm must be acknowledged and reset by manually pressing the appropriate buttons or by activating the LogicsManager output "External acknowledgment" (via a discrete input or via an interface).
			[No]	Notes This parameter is only visible, if wire break monitoring is not set to "Off".
4427 4428 4429	Filter time constant	2	Off, 1 to 5	A filter time constant may be used to reduce the fluctuation of an analog input reading. The cut-off-frequency is defined as usual with 63% (e^{-1})
				Notes This filter time constant assesses the average of the signal according to the following formula: Cut-off-frequency = $1 / (640 \text{ ms} \times 2 \times \pi \times 2^{N-1})$ whereby "N" is the filter time constant.
			Off	The analog input is displayed without filtering.
			1	Cut-off-frequency = 7.96 Hz (filter time constant = 0.02 s)
			2	Cut-off-frequency = 3.98 Hz (filter time constant = 0.04 s)
			[3]	Cut-off-frequency = 1.99 Hz (filter time constant = 0.08 s)
			4	Cut-off-frequency = 0.99 Hz (filter time constant = 0.16 s)
	5	Cut-off-frequency = 0.5 Hz (filter time constant = 0.32 s)		

ID	Parameter	CL	Setting range [Default]	Description
3638 3640 3642	Bargraph minimum	2	-21000000.00 to 21000000.00 [0.00]	The start value for the bar graph display of the analog input is defined here. The value must be entered according to the display format, which refers to the analog input type.
3639 3641 3643	Bargraph maximum	2	-21000000.00 to 21000000.00 [10.00]	The start value for the bar graph display of the analog input is defined here. The value must be entered according to the display format, which refers to the analog input type.
7073 7077 7081	Unit	2	1 to 6 characters [_ _ _ _ _]	This parameter is assigning a unit text to the displayed analog value. Notes If »°C« or »bar« is assigned the unit will be converted automatically if the corresponding parameter for conversion ↪ 3630 and/or ↪ 3631 is configured to YES.

4.4.2.4.4 Analog Inputs 7 to 10 (0 to 250 Ω | 0 to 2500 Ω)**General notes**

Monitoring of the analog inputs (overrun/underrun) must be configured manually to the flexible limits ([↪ "4.5.5 Flexible Limits"](#)).

Parameters for configuration

ID	Parameter	CL	Setting range [Default]	Description
7024 7032 7040 7048	Description	2	1 to 16 characters [Analog input {x}]	User-defined text. The event history will store this text message and it is also displayed on the visualization screen. Notes This parameter may only be configured using ToolKit. "x" should be 7 to 10 in accordance with ToolKit and the wiring table.
4343 4354 4365	Type	2	According to the following parameters different measuring ranges are possible at the analog inputs: [Off]	The analog input is switched off.

4 Configuration

4.4.2.4.4 Analog Inputs 7 to 10 (0 to 250 Ω | 0 to 2500 Ω)

ID	Parameter	CL	Setting range [Default]	Description
4376			VDO 5bar	The value of the analog input is interpreted with the VDO characteristics 0 to 5 bar.
			VDO 10bar	The value of the analog input is interpreted with the VDO characteristics 0 to 10 bar.
			VDO 150°C	The value of the analog input is interpreted with the VDO characteristics 50 to 150 °C.
			VDO 120°C	The value of the analog input is interpreted with the VDO characteristics 40 to 120 °C.
				Notes For the characteristic curves of the inputs refer to Chapter "VDO Inputs Characteristics".
			Pt100	The value of the analog input is interpreted with a Pt100 characteristic.
			Pt1000	The value of the analog input is interpreted with a Pt1000 characteristic.
			AB 94099	The value of the analog input is interpreted with a characteristic according the NTC-sender "94099" of the AB-Elektronik Sachsen GmbH
			Linear	Each analog input may be assigned to a linear characteristic curve, which can be only used for the respective defined input [T{x}] (x = 7 to 10). The minimum (0%) and maximum (100%) value refers to the total measuring range of the analog input (i.e. 0 to 250 Ohms or 0 to 2500 Ohms) or the values configured as "Sender value at display min." and "Sender value at display max.".
			Table A / Table B	The analog input is assigned to a characteristic curve which is defined over 9 points (stored in a table). Two independent tables (table A and table B) may be allocated to the analog inputs. Note that if these tables are to be used with the analog inputs, the defined points of these tables must be programmed into the control unit.
4344	User defined min display value (User defined minimum display value)	2	-21000000.00 to 21000000.00 [0.00]	The value (y-axis) to be displayed for the minimum of the input range must be entered here.
4355				Notes
4366				
4377				

ID	Parameter	CL	Setting range [Default]	Description
				This parameter is only visible if the parameter "Type" is configured to "Linear".
4345 4356 4367 4378	User defined max display value (User defined maximum display value)	2	-21000000.00 to 21000000.00 [2500.00]	The value (x-axis) to be displayed for the maximum of the input range must be entered here. Notes This parameter is only visible if the parameter "Type" is configured to "Linear".
4350 4361 4372 4383	Sender value at display min. (Sender value at display minimum)	2	0.000 to 2500.000 [0.000]	The value of the configured input range, which shall correspond with the minimum value configured for the display, must be entered here. This specifies the lower limit of the hardware range to be measured. Example If the input range is 0 to 2500 Ohms and the value configured here is 100, an analog input value of 100 Ohms would correspond with the minimum value configured for the display. Notes This parameter is only visible if the parameter "Type" is configured to "Linear", "Table A", or "Table B".
4351 4362 4373 4384	Sender value at display max. (Sender value at display maximum)	2	0.000 to 2500.000 [2500.000]	The value of the configured input range, which shall correspond with the maximum value configured for the display, must be entered here. This specifies the upper limit of the hardware range to be measured. Example If the input range is 0 to 2500 Ohm and the value configured here is 1000, an analog input value of 1000 Ohm would correspond with the minimum value configured for the display. Notes This parameter is only visible if the parameter "Type" is configured to "Linear", "Table A", or "Table B".
4349 4360 4371	Sender type	2		The software in the control unit may be configured for various types of sensors. The configurable ranges apply to the linear analog input.

4 Configuration

4.4.2.4.4 Analog Inputs 7 to 10 (0 to 250 Ω | 0 to 2500 Ω)

ID	Parameter	CL	Setting range [Default]	Description
4382			0 - 250 Ohm	The measuring range of the analog input is 0 to 250 Ohms.
			[0 - 2500 Ohm]	The measuring range of the analog input is 0 to 2500 Ohms.
				<p>Notes</p> <p>For RTD measurement purposes it is recommend to use for the 0 to 250 Ohm measuring range the 3-wire connection. Refer to ↳ "3.3.12.2 Analog Inputs (0/4 to 20 mA 0 to 10 V)".</p>
4353	Offset	2	-20.0 to 20.0 Ohm	The resistive input may be calculated with a permanent offset to adjust for inaccuracies. If the offset feature is utilized, the value configured in this parameter will be added to/subtracted from the measured resistive value.
4364			[0.0 Ohm]	
4375				
4386				
4346	Monitoring wire break	2		The respective analog input can be monitored for wire breaks. If this protective function is triggered, the display indicates "Wb: {Text of Parameter [Description]}". The following configurations are used to monitor for wire breaks:
4357			High	If the actual value rises over the maximum value (overshoot), this is identified as a wire break.
4368			Low	If the actual value falls below the minimum value (undershoot), this is identified as a wire break.
4379			High/Low	If the actual value rises over the maximum value (overshoot) or falls below the minimum value (undershoot), this is identified as a wire break.
			[Off]	No wire break monitoring is performed.
				<p>Notes</p> <p>Monitoring of the analog inputs (overrun/underrun) must be configured manually to the flexible limits (refer to chapter ↳ "4.5.5 Flexible Limits").</p> <p>If the control unit detects that the measuring range for an analog input has been exceeded and an alarm is issued, the limit value monitoring of this analog input is disabled and an error message is displayed. The measuring range is recognized as being exceeded and an alarm is issued:</p>

ID	Parameter	CL	Setting range [Default]	Description
				<p>0 to 250 Ohm:</p> <p>Minimum value 2.5 Ohms Undershooting</p> <p>Maximum value 255 Ohms Overshooting</p> <p>0 to 2500 Ohm:</p> <p>Minimum value 25 Ohms Undershooting</p> <p>Maximum value 2550 Ohms Overshooting</p>
4347 4358 4369 4380	Wire break alarm class	2	Class A, Class B, Class C, Class D, Class E, Class F , Control	<p>Each limit may be assigned an independent alarm class that specifies what action should be taken when the limit is surpassed.</p> <p>Class A / Class B Warning alarm classes.</p> <p>Class C / Class D / Class E / Class F Shutdown alarm classes.</p> <p>Control to issue a control command only.</p>
			[Class B]	<p>Notes</p> <p>This parameter is only visible, if wire break monitoring is not set to "Off".</p>
4348 4359 4370 4381	Self acknowledge wire break	2	Yes	<p>The control automatically clears the alarm if the fault condition is no longer detected.</p>
			[No]	<p>The control does not automatically reset the alarm when the fault condition is no longer detected. The alarm must be acknowledged and reset by manually pressing the appropriate buttons or by activating the LogicsManager output "External acknowledgment" (via a discrete input or via an interface).</p>
				<p>Notes</p> <p>This parameter is only visible, if wire break monitoring is not set to "Off".</p>
4430 4431 4432 4433	Filter time constant	2	Off, 1 to 5	<p>A filter time constant may be used to reduce the fluctuation of an analog input reading.</p> <p>The cut-off-frequency is defined as usual with 63% (e^{-1}).</p>
			Off	<p>The analog input is displayed without filtering.</p>
			1	<p>Cut-off-frequency = 1.6 Hz (filter time constant = 0.1 s)</p>

ID	Parameter	CL	Setting range [Default]	Description
			2	Cut-off-frequency = 0.8 Hz (filter time constant = 0.2 s)
			[3]	Cut-off-frequency = 0.4Hz (filter time constant = 0.4 s)
			4	Cut-off-frequency = 0.2 Hz (filter time constant = 0.8 s)
			5	Cut-off-frequency = 0.1 Hz (filter time constant = 1.6 s)
3644 3646 3648 3650	Bargraph minimum	2	-2100000.00 to 21000000.00 [0.00]	The start value for the bar graph display of the analog input is defined here. The value must be entered according to the display format, which refers to the analog input type.
3645 3647 3649 3651	Bargraph maximum	2	-2100000.00 to 21000000.00 [2500.00]	The start value for the bar graph display of the analog input is defined here. The value must be entered according to the display format, which refers to the analog input type.
7085 7089 7093 7097	Unit	2	1 to 6 characters [_ _ _ _ _]	This parameter is assigning a unit text to the displayed analog value. Notes If »°C« or »bar« is assigned the unit will be converted automatically if the corresponding parameter for conversion ↔ 3630 , ↔ 3631 is configured to YES.

4.4.2.5 Analog Outputs

4.4.2.5.1 Analog Outputs 1 and 2

The analog outputs AO 1 and AO 2 may either be configured as analog or PWM outputs. The analog outputs are prepared for speed and voltage biasing signal for a speed controller and voltage regulator.

- The following table shows two configuration examples with parameters and default values for the analog outputs 1 and 2.
- Example 1 at AO 1 is for a generator active power output at AO 1 with a range of -20 kW to 220 kW via a 4 to 20 mA signal (generator rated power = 200 kW).
- Example 2 at AO 2 is assigning the speed bias signal (0 to 100%) to PWM signal (0 to 100%) with level 6 V.

✳

Configuration examples

Parameter / AnalogManager	Example 1 with AO 1		Example 2 with AO 2	
	ID	Value	ID	Value
Selected hardware type (For details refer to Table)	5201	mA	5215	PWM
Minimum hardware level	5208	4	5222	0.00 (%)
Maximum hardware level	5209	20 (mA)	5223	100.00 (%)
PWM output level (visible only if »PWM« selected)	5210	—	5224	6 V
Source value at minimum level	5204	-20 (kW)	5218	0 (%)
Source value at maximum level	5206	220 (kW)	5220	100 (%)
Filter time constant	5203	3	5217	Off
AM Data source AO1	5200	Type: Pass through A1 = 01.74 Gen.act.power [W]	5214	Type: Pass through A1 = 11.03 Speed bias [%]
Analog output 1	10310	Display of resulting value	10311	Display of resulting value

✧ **Settings/setup example**

The following drawing shows the relation between the value of the AO signal selected and its corresponding values at the terminal pin. For settings see table below the drawing.

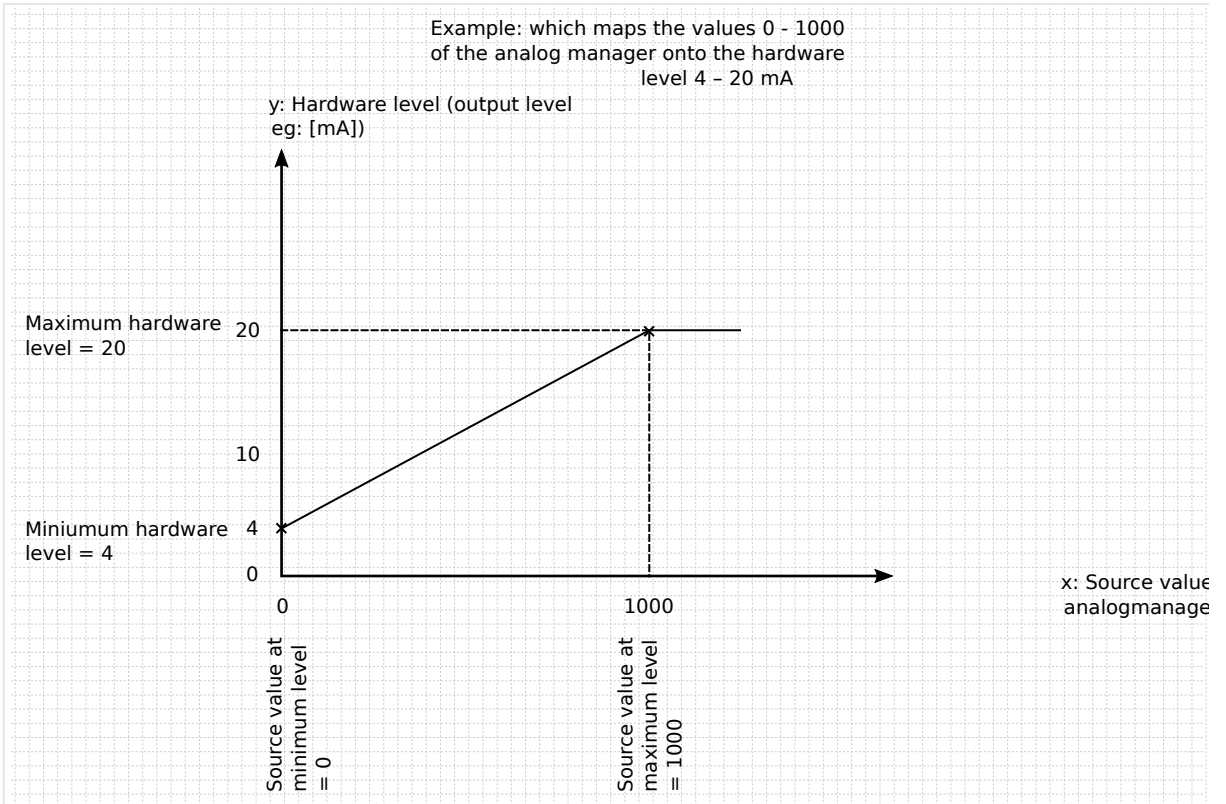

Fig. 179: Example to setup AO for 0 to 1000 IN becomes OUT 4 to 20 mA

Parameter / AnalogManager	Example 3 with AO 1	
	ID	
Selected hardware type (For details refer to Table)	5201	mA
Minimum hardware level	5208	4
Maximum hardware level	5209	20 mA
PWM output level (visible only if »PWM« selected)	5210	—
Source value at minimum level	5204	0
Source value at maximum level	5206	1000
Filter time constant	5203	3
AM Data source AO1	5200	Type: Pass through A1 = analog variable with range 0 to 1000
Analog output 1	10310	Display of resulting value

ID	Parameter	CL	Setting range [Default]	Description
5200 5214	AM Data source AO1	2	Determined by AnalogManager 93.01, 93.02 AO1: [A1 = 11.03 Speed bias [%] AO2: [A1 = 11.02 Voltage bias [%]	The data source may be selected from the available data sources. Notes Refer to ↗ “9.4.2 Data Sources AM” for a list of all data sources.
5201 5215	Selected hardware type	2		This parameter is used to configure the appropriate type of analog controller signal. The range of the analog output is configured here. PWM value is defined in %.
			Off	No analog output signal will be issued.
			[mA]	Notes
			V	Because of different isolation purposes the two biasing outputs must be clear labeled with their function.
			PWM	
5208 5222	Minimum hardware level (User defined minimum output value)	2	-20.00 to 100.00 [0.00]	The value of the configured hardware range, which shall correspond with the configured minimum source value, must be entered here (y-axis). This specifies the minimum limit of the hardware range. Example If the value configured here is 2.5, the maximum output range of “+/-20 mA” / “+/-10 V” has a lower limit of 2.5 mA / 2.5 V. Notes Value »100« is possible only for PWM.
5209 5223	Maximum hardware level (User defined maximum output value)	2	-20.00 to 100.00 [20.00]	The value of the configured hardware range, which shall correspond with the configured maximum source value, must be entered here (y-axis). This specifies the maximum limit of the hardware range. Example If the value configured here is 7.5, the maximum output range of “+/-20 mA” / “+/-10 V” has a upper limit of 7.5 mA / 7.5 V. Notes Value »100« is possible only for PWM.

4 Configuration

4.4.2.5.1 Analog Outputs 1 and 2

ID	Parameter	CL	Setting range [Default]	Description
5210 5224	PWM output level	2	0.00 to 10.00 V [10.00 V]	If PWM has been enabled in parameter ↔ 5203/↔ 5217 , is defined in %, and the level of the PWM signal (amplitude) may be adjusted here.
5204 5218	Source value at minimum level	2	-21000000.00 to 21000000.00 [0.00]	The value from the data source must exceed the value configured here to raise the output signal above minimum hardware level. Negative values may be used to change the sign e.g. for power. The entry format of the value depends on the selected data source.
5206 5220	Source value at maximum level	2	-21000000.00 to 21000000.00 [100.00]	If the value from the data source reaches the value configured here, the output signal will reach maximum hardware level. Negative values may be used to change the sign e.g. for power. The entry format of the value depends on the selected data source.
5203 5217	Filter time constant CL05	2	Off, 1 to 7 [Off]	A filter time constant may be used to reduce the fluctuation of an analog output value.
			1	Cut-off-frequency = 3.98 Hz (filter time constant = 0.04 s)
			2	Cut-off-frequency = 1.98 Hz (filter time constant = 0.08 s)
			3	Cut-off-frequency = 0.99 Hz (filter time constant = 0.16 s)
			4	Cut-off-frequency = 0.5 Hz (filter time constant = 0.32 s)
			5	Cut-off-frequency = 0.25 Hz (filter time constant = 0.64 s)
			6	Cut-off-frequency = 0.12 Hz (filter time constant = 1.28 s)
			7	Cut-off-frequency = 0.06 Hz (filter time constant = 2.56 s)
				Notes The filter is not applied to the analog output display value, i.e. the end value of the analog output is displayed immediately.

4.4.2.5.2 Analog Outputs 3 to 6

ID	Parameter	CL	Setting range [Default]	Description
5228 5242 5256 5270	AM Data source AO3	2	Determined by AnalogManager AO 03: [A1 = 01.05 Gen.volt.L-L [%]] AO 04: [A1 = 01.24 Gen.act.power [%]] AO 05: [A1 = 01.20 Gen. PF [%]] AO 06: [A1 = 01.09 Gen.frequency [%]]	The data source may be selected from the available data sources. Notes Refer to ↪ "9.4.2 Data Sources AM" for a list of all data sources.
5232 5246 5260 5274	Source value at minimum level	2	-21000000.00 to 21000000.00 [0.00]	The value from the data source must exceed the value configured here to raise the output signal above minimum hardware level. Negative values may be used to change the sign e.g. for power. The entry format of the value depends on the selected data source.
5234 5248 5262 5276	Source value at maximum level	2	-21000000.00 to 21000000.00 [100.00]	If the value from the data source reaches the value configured here, the output signal will reach maximum hardware level. Negative values may be used to change the sign e.g. for power. The entry format of the value depends on the selected data source.
5231 5245 5259 5273	Filter time constant	2	Off, 1 to 7	A filter time constant may be used to reduce the fluctuation of an analog output value.
			Off	The analog output is displayed without filtering.
			1	Cut-off-frequency = 0.663 Hz (filter time constant = 0.24 s)
			2	Cut-off-frequency = 0.332 Hz (filter time constant = 0.48 s)
			[3]	Cut-off-frequency = 0.166 Hz (filter time constant = 0.96 s)
			4	Cut-off-frequency = 0.083 Hz (filter time constant = 1.92 s)
			5	Cut-off-frequency = 0.041 Hz (filter time constant = 3.84 s)
			6	Cut-off-frequency = 0.021 Hz (filter time constant = 7.68 s)
			7	Cut-off-frequency = 0.010 Hz (filter time constant = 15.4 s)
				Notes The filter is not applied to the analog output display value, i.e.

ID	Parameter	CL	Setting range [Default]	Description
				the end value of the analog output is displayed immediately.
5229 5243 5257 5271	Selected hardware type	2	[Off] mA	Analog output is disabled, no analog output signal will be issued. Analog output is enabled.
5236 5250 5264 5278	Minimum hardware level (User defined minimum output value)	2	0.00 to 20.00 [0.00]	The minimum output value, which shall correspond with the minimum value of the output range, must be entered here. Notes This parameter is only active, if the selected hardware type is "user defined".
				Example If the value configured here is 20%, the minimum output would be 4 mA.
5237 5251 5265 5279	Maximum hardware level (User defined maximum output value)	2	0.00 to 20.00 [20.00]	The maximum output value, which shall correspond with the maximum value of the output range, must be entered here. Notes This parameter is only active, if the selected hardware type is "user defined".
				Example If the value configured here is 75%, the maximum output range would be 15 mA.

4.4.2.6 External Analog Inputs

General notes

Configuration of these external analog inputs is performed similarly to the internal analog inputs.

If an external expansion board (e.g. Phoenix Contact or WAGO) is connected to the easYgen via the CAN bus, it is possible to use 16 additional analog inputs.

- Refer to [Table](#) for the parameter IDs of the parameters for external analog inputs 1 through 16.



Please note that the available options for the parameters "Type" and "Sender type" differ from the internal analog inputs.

The parameters "Offset" and "Monitoring wire break" are not available for the external analog inputs.

- Refer to the Parameter List for details.



A wire break or sender failure is indicated by a dedicated value sent via the CAN bus ([↪ "4.7.4.1 CAN Interface 1"](#)).



For an example for the configuration of external analog inputs refer to [↪ "6.3.11 Setup Expansion Modules at CAN 2"](#).



Monitoring of the analog inputs (overrun/underrun) must be configured manually to the flexible limits ([↪ "4.5.5 Flexible Limits"](#)).

External analog inputs - parameter IDs

Parameter external	AI 1	AI 2	AI 3	AI 4	AI 5	AI 6	AI 7	AI 8
Description	16203	16213	16223	16233	16243	16253	16263	16273
Type1	5851	5864	5877	5890	5903	5916	5929	5942
User defined min display value	5852	5865	5878	5891	5904	5917	5930	5943
User defined max display value	5853	5866	5879	5892	5905	5918	5931	5944
Sender value at display min.	5857	5870	5883	5896	5909	5922	5935	5948
Sender value at display max.	5858	5871	5884	5897	5910	5923	5936	5949
Sender type	5856	5869	5882	5895	5908	5921	5934	5947
Sender connection type	5859	5872	5885	5898	5911	5924	5937	5950
Filter time constant	5863	5876	5889	5902	5915	5928	5941	5954

4 Configuration

4.4.2.6 External Analog Inputs

Parameter external	AI 1	AI 2	AI 3	AI 4	AI 5	AI 6	AI 7	AI 8
Exponent for protocol	16204	16214	16229	16234	16244	16254	16264	16274
Wire break alarm class	5854	5867	5880	5893	5906	5919	5932	5945
Self acknowledge wire break	5855	5868	5881	5894	5907	5920	5933	5946
Unit	16208	16218	16228	16238	16248	16528	16268	16278
Bargraph minimum	5861	5874	5887	5900	5913	5926	5939	5952
Bargraph maximum	5862	5875	5888	5901	5914	5927	5940	5953

Parameter external	AI 9	AI 10	AI 11	AI 12	AI 13	AI 14	AI 15	AI 16
Description	16283	16293	16303	16313	16323	16333	16343	16353
Type	5955	5968	5981	6930	6943	6956	6969	6982
User defined min display value	5956	5969	5982	6931	6944	6957	6970	6983
User defined max display value	5957	5970	5983	6932	6945	6958	6971	6984
Sender value at display min.	5961	5974	5987	6936	6949	6962	6975	6988
Sender value at display max.	5962	5975	5988	6937	6950	6963	6976	6989
Sender type	5960	5973	5986	6935	6948	6961	6974	6987
Sender connection type	5963	5976	5989	6938	6951	6964	6977	6990
Filter time constant	5967	5980	5993	6942	6955	6968	6981	6994
Exponent for protocol	16284	16294	16304	16314	16324	16334	16344	16354
Wire break alarm class	5958	5971	5984	6933	6946	6959	6972	6985
Self acknowledge wire break	5959	5972	5985	6934	6947	6960	6973	6986

Parameter external	AI 9	AI 10	AI 11	AI 12	AI 13	AI 14	AI 15	AI 16
Unit	16288	16298	16308	16318	10390	10392	10394	10396
Bargraph minimum	5965	5978	5991	6940	6953	6966	6979	6992
Bargraph maximum	5966	5979	5992	6941	6954	6967	6980	6993

External analog inputs - example configuration analog input 1



Please make sure that the selected settings you are using are supported by your external devices.

Available "Type"s (parameters 5851, 5864, ...)		
Off	Table A	Pt DIN(R0)
Linear	Table B	Pt SAMA(R0)
	TC Type K	Ni DIN(R0)
	TC Type J	Ni SAMA(R0)
	TC Type E	Cu10
	TC Type R	Cu50
	TC Type S	Cu53
	TC Type T	Ni 1000(Landis)
	TC Type B	Ni 500(Viessm.)
	TC Type N	KTY 81-110
	TC Type U	KTY 84
	TC Type L	
	TC Type C	
	TC Type W	
	TC Type HK	

Available "Sender type"s (parameters 5856, 5869, ...)	
0 - 10 V	R0=100
±10 V	R0=10
0 - 20 mA	R0=20
±20 mA	R0=30
4 - 20 mA	R0=50
0 - 400 Ohms	R0=120
0 - 4000 Ohms	R0=150

Available "Sender type"s (parameters 5856, 5869, ...)	
Thermocouple	R0=200
	R0=240
	R0=300
	R0=400
	R0=500
	R0=1000
	R0=1500
	R0=2000
	R0=3000

Available "Sender connection type"s (parameters 5859, 5872, ...)
Two wire
Three wire

4.4.2.7 External Analog Outputs

If an external expansion board (e.g. from Phoenix Contact or WAGO) is connected to the easYgen via the CAN bus, it is possible to use 4 additional analog outputs.



The configuration of these external analog outputs is performed similarly to the internal analog outputs.

Refer to [Table 60](#) for the parameter IDs of the parameters for external analog outputs 1 through 4.

Please note that the available options for the Selected hardware type are limited. Refer to the Parameter List for details.

Parameter	Ext. AO 1	Ext. AO 2	Ext. AO 3	Ext. AO 4
Data source ext. AO {x}	10237	10247	10257	10267
	AnalogManager: [Pass Through of "11.03 Speed bias [%]"]			
Source value at minimum level	10240	10250	10260	10270
Source value at maximum level	10241	10251	10261	10271
Filter time constant	10239	10249	10259	10269
Selected hardware type	10238	10248	10258	10268
	Setting range: Off; mA; V			
Minimum hardware level	10242	10252	10262	10272

Parameter	Ext. AO 1	Ext. AO 2	Ext. AO 3	Ext. AO 4
Maximum hardware level	10243	10253	10263	10273
Ext. analog output {x} (displayed in ToolKit only: ON/OFF)	10245	10255	10265	10275
Notes: Refer to Chapter 4.4.2.7 for details and definition of the parameters.				

Table 60: External analog outputs {1 to 4} - parameter IDs

ID	Parameter	CL	Setting range [Default]	Description
10237 10247 10257 10267	AM Data source ext.AO1	2	Determined by AnalogManager 93.21 .. 93.24 AO1 to AO 4: [A1 = "11.03 Speed bias [%]"	The data source may be selected from the available data sources. Notes Refer to "9.4.2 Data Sources AM" for a list of all data sources.
10238 10248 10258 10268	Selected hardware type	2	[Off] mA V	This parameter is used to configure the appropriate type of analog controller signal. The range of the analog output is configured here. No analog output signal will be issued.
10242 20252 10262 10272	Minimum hardware level (User defined minimum output value)	2	0.00 to 20.00 [0.00]	The value of the configured hardware range, which shall correspond with the configured minimum source value, must be entered here (y-axis). This specifies the minimum limit of the hardware range. Example If the value configured here is 2.5, the maximum output range of +/-20 mA / +/-10 V has a lower limit of 2.5 mA / 2.5 V.
10243 10253 10263 10273	Maximum hardware level (User defined maximum output value)	2	0.00 to 20.00 [20.00]	The value of the configured hardware range, which shall correspond with the configured maximum source value, must be entered here (y-axis). This specifies the maximum limit of the hardware range. Example If the value configured here is 7.5, the maximum output range of

4 Configuration

4.4.2.7 External Analog Outputs

ID	Parameter	CL	Setting range [Default]	Description
				+/-20 mA / +/-10 V has a upper limit of 7.5 mA / 7.5 V.
10240 10250 10260 10270	Source value at minimum level	2	-21000000.00 to 21000000.00 [0.00]	The value from the data source must exceed the value configured here to raise the output signal above minimum hardware level. Negative percentage values may be used to change the sign, e.g. for power. The entry format of the value depends on the selected data source.
10241 10251 10261 10271	Source value at maximum level	2	-21000000.00 to 21000000.00 [10000.00]	If the value from the data source reaches the value configured here, the output signal will reach maximum hardware level. Negative percentage values may be used to change the sign, e.g. for power. The entry format of the value depends on the selected data source.
10239 10249 10259 10269	Filter time constant	2	Off, 1 to 7 [Off] 1 2 3 4 5 6 7	A filter time constant may be used to reduce the fluctuation of an analog output value. The analog output is displayed without filtering. Cut-off-frequency = 3.98 Hz (filter time constant = 0.04 s) Cut-off-frequency = 1.98 Hz (filter time constant = 0.08 s) Cut-off-frequency = 0.99 Hz (filter time constant = 0.16 s) Cut-off-frequency = 0.5 Hz (filter time constant = 0.32 s) Cut-off-frequency = 0.25 Hz (filter time constant = 0.64 s) Cut-off-frequency = 0.12 Hz (filter time constant = 1.28 s) Cut-off-frequency = 0.06 Hz (filter time constant = 2.56 s)
				Notes The filter is not applied to the analog output display value, i.e. the end value of the analog output is displayed immediately.

4.4.2.8 External Discrete Inputs

If a Woodward IKD 1 or other external expansion board (e.g. Phoenix Contact or WAGO) is connected to the easYgen via the CAN bus, it is possible to use 32 additional discrete inputs.



- The configuration of these external DIs is performed similarly to the internal DIs (↳ “4.4.2.2 Discrete Inputs”).
- Refer to ↳ Table 61 for the parameter IDs of the parameters for external DIs 1 through 32.

External	DI 1	DI 2	DI 3	DI 4	DI 5	DI 6	DI 7	DI 8
Description	16200	16210	16220	16230	16240	16250	16260	16270
Delay	16000	16010	16020	16030	16040	16050	16060	16070
Operation	16001	16011	16021	16031	16041	16051	16061	16071
Alarm class	16002	16012	16022	16032	16042	16052	16062	16072
Self acknowledge	16004	16014	16024	16034	16044	16054	16064	16074
Enabled	16003	16013	16023	16033	16043	16053	16063	16073

Table 61: External discrete inputs - parameter IDs 1..8

External	DI 9	DI 10	DI 11	DI 12	DI 13	DI 14	DI 15	DI 16
Description	16280	16290	16300	16310	16320	16330	16340	16350
Delay	16080	16090	16100	16110	16120	16130	16140	16150
Operation	16081	16091	16101	16111	16121	16131	16141	16151
Alarm class	16082	16092	16102	16112	16122	16132	16142	16152
Self acknowledge	16084	16094	16104	16114	16124	16134	16144	16154
Enabled	16083	16093	16103	16113	16123	16133	16143	16153

Table 62: External discrete inputs - parameter IDs 9..16

External	DI 17	DI 18	DI 19	DI 20	DI 21	DI 22	DI 23	DI 24
Description	16201	16211	16221	16231	16241	16251	16261	16271
Delay	16005	16015	16025	16035	16045	16055	16065	16075
Operation	16006	16016	16026	16036	16046	16056	16066	16076
Alarm class	16007	16017	16027	16037	16047	16057	16067	16077
Self acknowledge	16009	16019	16029	16039	16049	16059	16069	16079
Enabled	16008	16018	16028	16038	16048	16058	16068	16078

Table 63: External discrete inputs - parameter IDs 17..24

External	DI 25	DI 26	DI 27	DI 28	DI 29	DI 30	DI 31	DI 32
Description	16281	16291	16301	16311	16321	16331	16341	16351

External	DI 25	DI 26	DI 27	DI 28	DI 29	DI 30	DI 31	DI 32
Delay	16085	16095	16105	16115	16125	16135	16145	16155
Operation	16086	16096	16106	16116	16126	16136	16146	16156
Alarm class	16087	16097	16107	16117	16127	16137	16147	16157
Self acknowledge	16089	16099	16109	16119	16129	16139	16149	16159
Enabled	16088	16098	16108	16118	16128	16138	16148	16158

Table 64: External discrete inputs - parameter IDs 25..32

4.4.2.9 External Discrete Outputs

If a Woodward IKD 1 or other external expansion board (e.g. Phoenix Contact or WAGO) is connected to the easYgen via the CAN bus, it is possible to use 32 additional discrete outputs.



The configuration of the external DOs is performed in a similar way like for the internal DOs.

Refer to [Table 65](#) for the parameter IDs of the parameters for external discrete outputs 1 through 32.

External	DO 1	DO 2	DO 3	DO 4	DO 5	DO 6	DO 7	DO 8
Parameter ID	12330	12340	12350	12360	12370	12380	12390	12400

Table 65: External discrete outputs - parameter IDs (1 to 8)

External	DO 9	DO 10	DO 11	DO 12	DO 13	DO 14	DO 15	DO 16
Parameter ID	12410	12420	12430	12440	12450	12460	12470	12480

Table 66: External discrete outputs - parameter IDs (9 to 16)

External	DO 17	DO 18	DO 19	DO 20	DO 21	DO 22	DO 23	DO 24
Parameter ID	12331	12332	12333	12334	12335	12336	12337	12338

Table 67: External discrete outputs - parameter IDs (17 to 24)

External	DO 25	DO 26	DO 27	DO 28	DO 29	DO 30	DO 31	DO 32
Parameter ID	12339	12341	12342	12343	12344	12345	12346	12347

Table 68: External discrete outputs - parameter IDs (25 to 32)

4.4.3 Configure Breakers

General notes



The assignment of the defined relays to defined functions occurs by selection of the application mode (i.e. function "Command: Close GCB" on relay [R 6], this relay can no longer be operated via the LogicsManager).

The same way some relays are designated to specific functions, others may be assigned to different functions. These are listed as "programmed" relays. If a relay is "programmable" the function may be assigned to other relays via the LogicsManager by configuration.

For additional information refer to [4.4.2.3 Discrete Outputs \(LogicsManager\)](#).



If the easYgen is intended to be operated in parallel with the mains, the mains voltage measuring inputs must be connected. If an external mains decoupling is performed, jumpers between busbar and mains voltage measuring inputs may be installed.



Changing the application mode will not change other configured values in the parameters. The application mode parameter is the only one.

Operation of the circuit breakers

The configuration of pulse switching takes place in the following screen and has the described effect on the signal sequence (the MCB cannot be controlled by the continuous pulse for security reasons, because otherwise, the MCB would be opened in case of a failure/exchange of the easYgen).

The parameter "Enable MCB" allows/prevents the closing of the MCB. A closed MCB will not be opened.

If the parameter "Auto unlock" is configured to YES, an open pulse will be issued prior to each close pulse.

External breaker handling

In operation mode AUTO the easYgen operates its breakers automatically according to the configured application and transition modes. Actually the breaker transition mode "external" would only allow the breaker closure from external. On the other hand the easYgen allows in special cases the closure of breaker from external, when the following configurations and modes are fulfilled:

External Breaker Handling	Synchronization Mode	Dead Bus Closure	Condition for the closure acceptance
GCB Synchronization	Off	-	<ul style="list-style-type: none"> The start request in automatic is active The generator is in operating range The engine start procedure is expired
GCB Dead bus closure	-	Off	
MCB Synchronization	Off	-	The mains is in operating range
GCB Dead bus closure	-	Off	

External Breaker Handling	Synchronizat- ion Mode	Dead Bus Closure	Condition for the closure acceptance
... and if GGB is available:			
GGB Synchronization	Off	-	Minimum 1 GCB is closed
GGB Dead bus closure	-	Off	

Interaction with LS-5

The easYgen provides some application modes, which contain the handling of the breaker control LS-5. According to the application mode a single LS-5 or a system of LS-5s is installed. The LS-5 technology shall give the designer an instrument to handle more complex breaker applications.

Here are some feature examples of the LS-5 technology:

- Open/close of individual breakers including synchronization and dead bus closure.
- Determining the generators in load share segments.
- Loading/unloading active and reactive power via the dedicated breaker.
- 3-phase power measurement at the interchange point to the utility.
- Included mains decoupling functions.



See further chapters in this document and in the LS-5 technical manual for more information.

4.4.3.1 Good to know: Actions with Breakers

4.4.3.1.1 Dead Bus Closing GCB



All parameters listed below only apply to application mode **A03** to **A11**

The unit closes the GCB without synchronization, if the following conditions are met. The display indicates "GCB dead bus close".

Automatic operation

- The operating mode AUTOMATIC has been selected
- No class C alarm or higher is present
- The engine is running
- The engine delayed monitoring (parameter [↩ 3315](#)) as well as the generator stable time (parameter [↩ 3415](#)) have been expired or the LogicsManager function "Undelay close GCB" (parameter [↩ 12210](#)) is enabled
- The generator voltage and frequency are within the configured operating range ([↩ 4.5.1.1 Generator Operating Ranges: Voltage / Frequency / Busbar](#))

- The MCB has been opened for at least the time configured in "Transfer time GCB↔MCB" (parameter ↩➤ 3400)

(Mode **A04**, **A06**, **A08**, **A09** and **A11** with open transition mode only)
- The function "Start without load" (parameter ↩➤ 12540) has been disabled through the LogicsManager
- Only in critical mode: the parameter "Close GCB in override" (parameter ↩➤ 4100) is configured to "Yes"
- The busbar voltage is below the dead bus detection limit (parameter ↩➤ 5820)
- There is no other GCB closed in the same segment
- There is no other device with a smaller device ID willing to close its GCB too (Dead busbar closure negotiation)

Manual operation

- The operating mode MANUAL has been selected.
- No class C alarm or higher is present.
- The engine is running.
- The engine delayed monitoring (parameter ↩➤ 3315) as well as the generator stable time (parameter ↩➤ 3415) have been expired.
- The generator voltage and frequency are within the configured operating range (↩➤ "4.5.1.1 Generator Operating Ranges: Voltage / Frequency / Busbar").
- The button "Close GCB" has been pressed.
- The MCB has been open for at least the time configured in "Transfer time GCB↔MCB" (parameter ↩➤ 3400).

(Mode **A04**, **A06**, **A08**, **A09** and **A11** with open transition mode only)
- The busbar voltage is below the dead bus detection limit (parameter ↩➤ 5820).
- There is no other GCB closed in the same segment.
- There is no other device with a smaller device ID willing to close its GCB too (Dead busbar closure negotiation).

Dead Busbar Negotiation

Each easYgen, who intends to close its GCB on a dead busbar publishes a "Dead busbar closure request" flag over CANbus and reads back whether there is any other easYgen publishing the same intension:

If not, the unit waits an estimated time for security and then closes its breaker.

If yes, the unit compares its own device number with the smallest device number of all others who also intend to close. If the own device number is smaller than the rest, the unit will close its breaker - otherwise it blocks its own closure.

The easYgen removes its wish to close its GCB on a dead busbar, if the GCB closure failure occurs in a multiple generator application. So the next easYgen with the higher device number gets the permission for closure.

The load sharing messages are monitored. In case of a “missing member” alarm on the load share bus, the single dead bus closures are delayed depending on the own Generator number to avoid simultaneous closure. The delay time is Generator Number multiplied with 500 ms.

The GCB dead busbar closure is realized faster, if LogicsManager "Undelayed close GCB" ID 12210 is set to TRUE.

The dead busbar negotiation is done over all segments by default (Parameter  3472 is set to On).

If Parameter  3472 is set to Off the dead busbar negotiation is done only for the own segment.

4.4.3.1.2 Synchronization GCB/MCB









All parameters listed below only apply to application mode **A03** to **A11**

The synchronization is active, if the following conditions are met simultaneously.

The display indicates "Synchronization GCB" or "Synchronization MCB".

Automatic operation

- The operating mode AUTOMATIC has been selected
- The mains voltage is available and within the configured operating range ( "4.5.3.3 Mains Operating Ranges")
- The generator and busbar voltage are available and within the configured operating range ( "4.5.1.1 Generator Operating Ranges: Voltage / Frequency / Busbar")
- The differential frequency/voltage is within the configured operating range
- Synchronizing the MCB
 - The GCB is closed (or at least one GCB is closed in a multiple genset application)
 - The busbar voltage is within the configured operating range
 - The "Enable MCB" (parameter  12923) signal is present, for example discrete input 6 is energized if configured as DI 6
- Synchronizing the GCB
 - The MCB is closed
 - The busbar voltage is within the configured operating range
 - Engine delayed monitoring (parameter  3315) and generator stable time (parameter  3415) have expired or "Undelay close GCB" (parameter  12210) is enabled

Manual operation

- Operating mode MANUAL has been selected

- The generator and busbar voltage are available and within the configured operating range (↳ "4.5.1.1 Generator Operating Ranges: Voltage / Frequency / Busbar")
- The differential frequency/voltage is within the configured operating range
- Synchronizing the MCB
 - The GCB is closed (or at least one GCB is closed in a multiple genset application)
 - The busbar voltage is within the configured operating range
 - The "Enable MCB" (parameter ↳ 12923) signal is present, for example discrete input 6 is energized if configured as DI 6
 - The button "Close MCB" has been pressed
- Synchronizing the GCB
 - The MCB is closed
 - The busbar voltage is within the configured operating range
 - Engine delayed monitoring (parameter ↳ 3315) and generator stable time (parameter ↳ 3415) have expired or "Undelay close GCB" (parameter ↳ 12210) is enabled
 - The button "Close GCB" has been pressed

4.4.3.1.3 Dead Bus Closing MCB



The following applies to application mode **A04** and **A06**.

The unit closes the MCB, if the following conditions are met simultaneously.

The display indicates "MCB dead bus close".

Automatic operation

- The operating mode AUTOMATIC has been selected
- The parameter "Dead busbar closure MCB" (parameter ↳ 3431) is configured On
- The mains voltage is available and within the configured operating range (↳ "4.5.3.3 Mains Operating Ranges")
- The GCB is open or has been opened for at least the "Transfer time GCB↔MCB" (parameter ↳ 3400) (open transition mode only)
- The "Enable MCB" (parameter ↳ 12923) signal is present, for example discrete input 6 is energized if configured as DI 6
- The busbar voltage is below the dead bus detection limit (parameter ↳ 5820)

Manual operation

- Operating mode MANUAL has been selected

- The parameter "Dead busbar closure MCB" (parameter [↩➤ 3431](#)) is configured "On"
- The mains voltage is available and within the configured operating range ([↩➤ "4.5.3.3 Mains Operating Ranges"](#))
- The GCB is open or has been opened for at least the "Transfer time GCB↔MCB" (parameter [↩➤ 3400](#)) (open transition mode only)
- The "Enable MCB" (parameter [↩➤ 12923](#)) signal is present, for example discrete input 6 is energized if configured so
- The button "Close MCB" has been pressed
- The busbar voltage is below the dead bus detection limit (parameter [↩➤ 5820](#))

4.4.3.1.4 Open GCB



The following applies to application modes **A02** to **A11**.

The GCB will be opened when the "Command GCB open" is issued. The behavior of the GCB open relay depends on the setting of parameter [↩➤ 3403](#).

If this parameter is configured as "N.O.", the relay energizes to open the GCB, if it is configured as "N.C.", the relay de-energizes to open the GCB.

The GCB will be opened under the following conditions:

- In STOP operating mode after unloading the generator
- In case of a class C alarm or higher
- By pressing the "GCB" or "MCB" softkey (depending on the CB logic which has been set) in MANUAL operating mode
- By pressing the button "stop engine" in MANUAL operating mode
- In the event of an automatic stopping in the AUTOMATIC operating mode (the start request has been terminated or a stop request has been initiated)
- In critical mode (Sprinkler operation), provided that an emergency power operation is not active, and "Close GCB in override" (parameter [↩➤ 4100](#)) has been configured to No
- If "Start without load" has been enabled through the LogicsManager and the breaker was closed
- By pressing the "MCB" softkey (depending on the CB logic which has been set) in MANUAL operating mode



The conditions above are only valid if the GCB is closed, whereas the following conditions are valid regardless of the GCB is open or closed.

- Prior to the MCB closing onto the dead busbar (depending on the CB logic which has been set)

- In case of an alarm of class D or F

4.4.3.1.5 Open MCB



The following applies to application modes **A04**, **A06**, **A08**, **A09** and **A11**.

The MCB will be opened when the relay "Command: MCB open" is energized.

The MCB will be opened under the following conditions if the MCB is closed:

- If an emergency power operation is initiated (mains failure) once the generator voltage is within the permissible limits
- Prior to the closure of the GCB (depending on the CB logic which has been set)
- Upon pressing the "MCB" or "GCB" softkey (dependent upon the configured CB logic) in MANUAL operating mode

4.4.3.1.6 Transition Modes (Breaker Logic)

Breaker logic "PARALLEL"

Parallel operation is enabled by configuring parameter 3411 to "PARALLEL".



Parallel breaker logic must be selected for the following operation modes:

- islanded operation
- Mains parallel operation

In the event of an engine start request the following occurs:

- The GCB is synchronized and closed
- The generator assumes load and the adjusted real power or reactive power setpoints are controlled

Following the stop request the following occurs:

- The generator sheds load until real power has reached the "Unload limit" (parameter 3125)
- The generator power factor is controlled to "1.00" (unity)
- The GCB is opened
- The engine is shut down following the configured cool down period



When a stop command is issued to the engine, soft loading (power reduction) is carried out before opening the GCB, except an alarm of class D or F is present.

Breaker logic "INTERCHANGE"

The following applies to application modes **A04**, **A06**, **A08**, **A09** and **A11**.



For this breaker logic to function correctly, the mains power measurement must be connected properly.

The following applies for the power display:

- Positive mains power = export power
- Negative mains power = import power

In the event of a start request, a change is made from mains to generator supply.

The following occurs:

- The GCB is synchronized and closed
- The generator assumes load until the imported mains interchange real power has reached 5 % of the "Generator rated active power" (parameter [↩ 1752](#))
- The MCB is opened

When a stop request has been issued, a change is made from generator to mains supply.

The following occurs:

- The MCB is synchronized and closed
- The generator sheds load until real power has reached the "Unload limit" (parameter [↩ 3125](#))
- The generator power factor is controlled to "1.00" (unity)
- The GCB is opened



The limit for opening the MCB during softloading (Unloading mains) is +/- 5% active generator rated power without any delay. In multiple generator mains applications the 5% limit is calculated out of the current nominal generator power in the system.

Examples:

- One engine is running with 1000kW rated, the +/-5% limit is a power window at the interchange point from 50kW import up to 50kW export.
- One engine is running with 500kW rated and another with 300kW rated, the +/-5% limit is a power window at the interchange point from 40kW import up to 40kW export.

Hint: The generator rated power is taken into account to find a good compromise between bumpless power transfer and being not too long mains parallel.

Breaker logic "CLOSED TRANSIT."

The following applies to application modes **A04**, **A06**, **A08**, **A09** and **A11**.

Closed transition (make-before-break/overlap synchronization) is enabled by configuring parameter 3411 to "CLOSED TRANSITION".

In the event of an engine start request, a change is made from mains to generator supply.

The following occurs:

- The GCB is synchronized and closed.
- The MCB is opened and the generator assumes all loads.

After the engine stop request has been issued, a change is made from generator to mains supply.

The following occurs:

- The MCB is synchronized and closed.
- The GCB is opened and the mains assume all loads.



The circuit breakers are opened irrespective of the power.

For the application modes **A04**, **A06** and **A12**, the breaker closed transition time matches the duration time <100 ms.



The maximum time between the reply from the CB and the CB open command is 100 ms.

Breaker logic "OPEN TRANSIT."

The following applies to application modes **A04**, **A06**, **A08**, **A09** and **A11**.

Open transition (break-before-make/change over logic) is enabled via configuration of parameter 3411 to "OPEN TRANSITION".

In the event of an engine start request, a change is made from mains to generator supply.

The following occurs:

- The MCB is opened
- The GCB is closed after the time configured in "Transfer time GCB<->MCB" (parameter 3400) has expired.

The following occurs:

- The GCB is opened
- The MCB is closed after the time configured in "Transfer time GCB<->MCB" (parameter  3400) has expired

Breaker logic "EXTERNAL"

External breaker logic is enabled via configuration of parameter  3411 to "EXTERNAL".

All breaker control (especially the CB closing instructions) must be carried out via master controller (e.g. a PLC).

The easYgen controller always issues additionally the breaker open command under fault conditions and in the breaker unloading states (Unloading GCB) if the stop request is active.

Overview for application mode A04

STOP	MANUAL	AUTOMATIC
<p>EXTERNAL: Breaker logic "External"</p> <p>In a mains parallel operation, decoupling from the mains is carried out via the MCB or the GCB in the event of a mains failure. The breakers will not automatically close in emergency power operation. Emergency power operation in accordance with European Community Specification DIN VDE 0108 is not possible in this power circuit breaker logic.</p>		
<p>The GCB is opened.</p>	<p>The MCB and the GCB may be manually opened. The circuit breakers are opened for decoupling from the mains.</p>	<p>The GCB is opened if the genset is stopped or if decoupling from the mains, but will not close if the engine is started. The MCB is opened only if decoupling from the mains, and is never closed.</p>
<p>PARALLEL: Breaker logic "Mains parallel operation"</p> <p>The MCB and GCB are synchronized to permit continuous mains parallel operation in this breaker logic mode.</p>		
<p>The GCB is opened; the MCB is operated depending on the setting of "Enable MCB" (parameter  12923).</p>	<p>Mains parallel operation can be initiated by pressing the "GCB On" or "MCB On" push-button.</p>	<p>The GCB is synchronized via an add-on request and a mains parallel operation is performed. When a shed-off request is issued, the generator sheds load and opens the GCB and the engine is shut down following the configured cool down period.</p> <p>Emergency power: The emergency power operation is terminated following the expiration of the mains settling time. The MCB is synchronized and closed, putting the system back into a mains parallel operation.</p>
<p>OPEN TRANSIT: Breaker logic "Open transition / change-over / brake-before-make"</p> <p>The MCB and GCB are never synchronized in this breaker logic mode.</p>		
<p>The GCB is opened; the MCB is operated depending on the setting of "Enable MCB" (parameter  12923).</p>	<p>A change can be made to either generator or mains operation by pressing either the "GCB On" or "MCB On" push-button. The "STOP" push-button opens the GCB and simultaneously stops the engine.</p>	<p>A change is made to generator operation through an add-on request. Once the add-on request is terminated, the system changes back to mains operation. The MCB is closed when the busbar is dead, even if there has not been an add-on request. Emergency power operations are terminated following the expiration of the mains settling timer. The GCB opens and the MCB closes, transferring all loads to the mains.</p>

STOP	MANUAL	AUTOMATIC
CLOSED TRANSIT: Breaker logic "Closed transition / make-before-brake / overlap synchronization"		
The MCB and the GCB are synchronized, in order to avoid a dead busbar in this breaker logic mode. Immediately after the synchronization of one breaker, the other is opened. Continuous mains parallel operation is not possible.		
The GCB is opened; the MCB is operated depending on the setting of "Enable MCB" (parameter ↩> 12923).	Synchronization of either the generator or the mains can be initiated by pressing the "GCB On" or "MCB On" push-button.	The GCB is synchronized via an add-on request. After the GCB closes the MCB is opened. Following the shed-off request being issued, the MCB is synchronized and closed. After the MCB has closed the GCB is opened. Emergency power: The emergency power operation is terminated following the expiration of the mains settling time and the MCB synchronizing to the generator. The MCB closes and the GCB opens immediately afterwards.
INTERCHANGE: Breaker logic "Soft loading / interchange synchronization"		
The MCB and the GCB are synchronized, in order to avoid a dead busbar in this breaker logic mode. The operation of a breaker under load is avoided by utilizing the ability to soft load. Continuous mains parallel operation is not possible with this breaker logic.		
Following the shed-off request, the MCB synchronizes and closes, the generator soft unloads to the mains and the GCB opens. After the GCB is open the engine is stopped following the expiration of the configured cool down period.		
The GCB is opened; the MCB is operated depending on the setting of "Enable MCB" (parameter ↩> 12923).	Synchronization of either the generator or the mains can be initiated by pressing the "GCB On" or "MCB On" push-button.	Via an engine request, the GCB is synchronized and the generator power is increased. The MCB is then opened. Following the disabling of the engine request, the MCB is reverse synchronized and the GCB is then opened. Emergency power: The emergency power operation is terminated following the expiration of the mains settling time. The MCB closes, the load is transferred, and the GCB opens.

Overview for application mode A03

STOP	MANUAL	AUTOMATIC
PARALLEL: Breaker logic "Mains parallel"		
This operation mode may be used both in the case of an islanded system, an islanded parallel system, and a system that is operated in mains parallel.		
The GCB is opened.	Mains parallel operation can be performed via the "GCB On" push-button.	The GCB is synchronized via an add-on request and mains parallel operation is performed. When a shed-off request is issued, the generator sheds load, the GCB is opened, and the engine is shut down following the configured cool down period.

4.4.3.1.7 GGB Handling

Introduction

Usually the easYgen treats the GGB always so that an open command is issued, if the GCB is opened. This is the GGB open mode.

In some applications this can lead to the issue that the AC power is separated from the generator bar in healthy mains situations. That means in times when the mains is feeding the load (MCB closed), the genset container (generator busbar) is not connected to AC power. But this is needed to support the battery charger and some other single consumers in standby situations. To fix that the GGB close mode is introduced.

The user can configure what adapts at best to his application.

Function

The easYgen3500XT includes a configuration which offers two modes for handling the GGB:

- GGB open mode
- GGB close mode

GGB open mode**AUTOMATIC operation:**

The GGB is generally opened, when all GCBs are opened. The closing of the GGB is performed, if the own GCB is closed and enough nominal generator power is available. (refer to parameter ID3440 "Min. gen power"). A LogicsManager equation can be set on TRUE to override this blocking factor.

MANUAL operation:

Generally the GGB holds the last condition of the other operation modes. The GGB is allowed to be closed, if the GCB is closed.

STOP operation:

The GGB is generally opened, when all GCBs are opened. The closing will never be executed.

GGB close mode**AUTOMATIC operation:**

The easYgen does not open automatically the GGB, when all GCBs are opened.

- The easYgen opens the GGB, if:
 - an emergency run situation is initiated (gen busbar gets dead)
 - the minimum generator power cannot be reached with a single genset. (Refer to ID 3440 "Min. generator power").

In these cases, the GGB is opened before the first GCB is closed. The first easYgen executes a GCB dead bus closure, others synchronize to generator busbar

- The reclosing of the GGB during standby situation is executed, if:

- The mains is ok AND
- the MCB is closed AND
- all GCBs are open AND
- no easYgen intends to do a GCB dead bus closure.

The easYgen never closes the GGB, if both sides of the GGB are dead. Exception: Run-up synchronization with GCB/GGB mode.



The closing of the GGB is finally performed, if the own GCB is closed and enough nominal generator power is available. (see parameter ID3440 "Min. gen power"). A LogicsManager equation can be set on TRUE to override this blocking factor.

MANUAL operation:

Generally the GGB holds the last condition of the other operation modes.

- The GGB is allowed to be closed, if the GCB is closed. The GGB is allowed to be closed on a dead generator busbar, if:
 - The mains is ok AND
 - the MCB is closed AND
 - all GCBs are open AND
 - no easYgen intends to do a GCB dead bus closure.

STOP operation:

The GGB is generally not operated.

Minimal Generator Power Consideration (*P_{min}*)

With a GGB installed in the application an available generator power on busbar can be considered.

To ensure that there is enough generator power available before closing the GGB, a minimal generator rated power can be configured. Refer to ID3440 "Min. Generator power". The transfer sequence is delayed until the correct amount of nominal power is available. In special circumstances the *P_{min}* consideration can be bypassed through a LogicsManager equation. Refer to ID12936 "Bypass min. Pgen."

This consideration is provided in the operation modes AUTOMATIC, MANUAL and TEST and in all breaker transition modes.

4.4.3.2 General Breaker Settings

ID	Parameter	CL	Setting range [Default]	Description
3444	Application mode	2		The unit may be configured to different application modes. The discrete inputs and relay outputs are pre-defined dependent upon

ID	Parameter	CL	Setting range [Default]	Description
				<p>the selected application mode. Only the screens and functions that pertain to the application mode selected are displayed. The single line diagram in the main screen will change.</p> <p>Refer to ↪ "2.2 Application Modes Overview" for additional information.</p>
			None	<p>Application mode A01</p> <p>The control unit will function as an engine start/stop control with generator and engine protection. All necessary inputs and outputs are assigned and pre-defined.</p>
			GCB open	<p>Application mode A02</p> <p>The control unit will function as an engine start/stop control with generator and engine protection. The control unit can only open the GCB. All necessary inputs and outputs are assigned and pre-defined.</p>
			GCB	<p>Application mode A03</p> <p>The control unit will function as a one-CB unit. The control unit performs full control like synchronizing, opening and closing the GCB with generator and engine protection. All necessary inputs and outputs are assigned and pre-defined.</p>
			[GCB/MCB]	<p>Application mode A04</p> <p>The control unit will function as a two-CB unit. The control unit performs full control like synchronizing, opening and closing the GCB and the MCB with generator and engine protection. The GCB/MCB perform also full load transfer via open/closed transition, interchange and parallel mode. All necessary inputs and outputs are assigned and pre-defined.</p>
			GCB/LSx	<p>Application mode A07</p> <p>In this mode the unit operates the GCB with close and open orders. All other breakers in the system are operated by the LSx. The CAN system allows here a maximum 16 LSx and 32 easYgen-3400/3500(XT) devices.</p>
			GCB/L-MCB	<p>Application mode A08</p>

ID	Parameter	CL	Setting range [Default]	Description
				In this mode the unit operates the breakers like in the mode "GCB/MCB". But instead of operating the MCB directly over relays the unit commands an LSx to operate the MCB.
			GCB/GGB	Application mode A05 In this mode the unit operates the GCB and a "Generator Group Breaker" (GGB) with close and open orders.
			GCB/GGB/MCB	Application mode A06 In this mode the unit operates the GCB, the GGB and the MCB with close and open orders.
			GCB/GGB/L-MCB	Application mode A09 In this mode the unit operates the breakers like in the mode "GCB/GGB/MCB". But instead of operating the MCB directly over relays the unit commands an LS-5 to operate the MCB.
			GCB/L-GGB	Application mode A10 In this mode the unit operates the breakers like in the mode "GCB/GGB". But instead of operating the GGB directly over relays the unit commands an LS-5 to operate the GGB. In comparison to the "GCB/GGB" mode, it does not allow a mains parallel operation. So this is a purely islanded operation mode.
			GCB/L-GGB/L-MCB	Application mode A11 In this mode the unit operates the breakers like in the mode "GCB/GGB/MCB". But instead of operating the MCB and GGB directly over relays the unit commands two single LS-5 to operate the MCB and GGB.
			GCB/L-GGBMCB	Application mode A12 In this mode the unit operates the breakers like in the mode "GCB/GGB/MCB". But instead of operating the GGB and MCB directly over relays the unit commands the LS-5x2 to operate the GGB and the MCB. The LS-5x2 must be accordingly configured to application mode L-GGBMCB.
			GCB/GC	GCB/GC Application mode A13 In this mode the unit operates the GCB with close and open orders. All other breakers in the system

4 Configuration

4.4.3.2 General Breaker Settings

ID	Parameter	CL	Setting range [Default]	Description
				<p>are operated by the Group Controller and eventually by LS-5. The system allows here a maximum 15 LS-5 and 31 easYgen-3400/3500(XT) devices in one group.</p> <p>Note:</p> <p>Because of its load share messages, the Group Controller appears as a LS5 with device number 33 and as an easYgen with device number 32 in the diagnostic screens. For this reason the device number 32 for the easygen and 33 for the LS5 are not allowed in this mode.</p>
3411	Breaker transition mode	2	<p>External</p> <p>Open Transition</p> <p>Closed Transit.</p> <p>Interchange</p> <p>[Parallel]</p>	<p>The control unit automatically controls the two breakers (MCB and GCB).</p> <p>Notes</p> <p>The following applies to application modes A04, A06, A08, A09, A11, and A12.</p> <p>For a detailed explanation for each mode refer to “4.4.3.1.6 Transition Modes (Breaker Logic)”.</p> <p>The unit provides two alternative transition modes, which may be activated temporarily via the LogicsManager and override the transition mode configured in this parameter.</p>
3412	Breaker transition mode 1	2	<p>External</p> <p>Open Transition</p> <p>Closed Transit.</p> <p>Interchange</p> <p>[Parallel]</p>	<p>The control unit automatically controls the two breakers (MCB and GCB).</p> <p>Notes</p> <p>The following applies to application modes A04, A06, A08, A09, A11, and A12.</p>

ID	Parameter	CL	Setting range [Default]	Description
				For a detailed explanation for each mode refer to ↗ “4.4.3.1.6 Transition Modes (Breaker Logic)”.
12931	Transition mode 1	2	Determined by LogicsManager 86.93 [(0 & 1) & 1] = 11922	<p>Once the conditions of the LogicsManager have been fulfilled, the transition mode configured in parameter ↗ 3412 will be used instead of the standard transition mode configured in parameter ↗ 3411.</p> <p>For information on the LogicsManager and its default settings see ↗ “9.3.1 LogicsManager Overview”.</p> <p>Notes</p> <p>The following applies to application modes A04, A06, A08, A09, A11, and A12.</p> <p>Alternative transition mode 1 has priority over alternative transition mode 2, i.e. if both LogicsManager functions (parameters ↗ 12931 and ↗ 12932) are TRUE, breaker transition mode 1 (parameter ↗ 3412) will be used.</p>
3413	Breaker transition mode 2	2		<p>The control unit automatically controls the two breakers (MCB and GCB).</p> <p>External</p> <p>Open Transition</p> <p>Closed Transit.</p> <p>Interchange</p> <p>[Parallel]</p> <p>Notes</p> <p>The following applies to application modes A04, A06, A08, A09, A11, and A12.</p> <p>For a detailed explanation for each mode refer to ↗ “4.4.3.1.6 Transition Modes (Breaker Logic)”.</p>
12932	Transition mode 2	2	Determined by LogicsManager 86.94 [(0 & 1) & 1] = 11923	<p>Once the conditions of the LogicsManager have been fulfilled, the transition mode configured in parameter ↗ 3412 will be used instead of the standard transition mode configured in parameter ↗ 3411.</p> <p>Notes</p> <p>Alternative transition mode 1 has priority over alternative transition mode 2, i.e. if both LogicsManager functions (parameters ↗ 12931 and ↗ 12932) are TRUE, breaker</p>

4 Configuration

4.4.3.2 General Breaker Settings

ID	Parameter	CL	Setting range [Default]	Description
				<p>transition mode 1 (parameter 3412) will be used.</p> <p>For information on the LogicsManager and its default settings see 9.3.1 LogicsManager Overview.</p>
3400	Transfer time GCB<->MCB	2	1.00 to 99.99 s [1.00 s]	<p>Switching from generator supply to mains supply or from mains supply to generator supply occurs automatically if the operating conditions have been met.</p> <p>The time between the reply "power circuit breaker is open" and a close pulse is set by this parameter. This time applies for both directions. During this time the consumers are de-energized.</p> <p>Notes</p> <p>The following applies to application modes A04, A06, A08, A09, A11, and A12.</p> <p>This is only valid, if parameter 3411 is configured to OPEN TRANSITION</p>
6676	LSx slip freq. separate offset	2	-0.50 to 0.50 Hz [-0.1 Hz]	<p>This is a separate slip frequency offset, being executed instead of the "standard slip frequency offset" 5502 if the easYgen-XT receives an according flag "Synchronization with separated slip frequency offset". The flag is sent by the LSx (series II) Load share message.</p> <p>Notes</p> <p>This is usually receipt from an LSx, which synchronizes a breaker at the interchange point to mains. Here exporting power to mains must be avoided.</p>

4.4.3.3 Configure Breakers: GCB

General notes

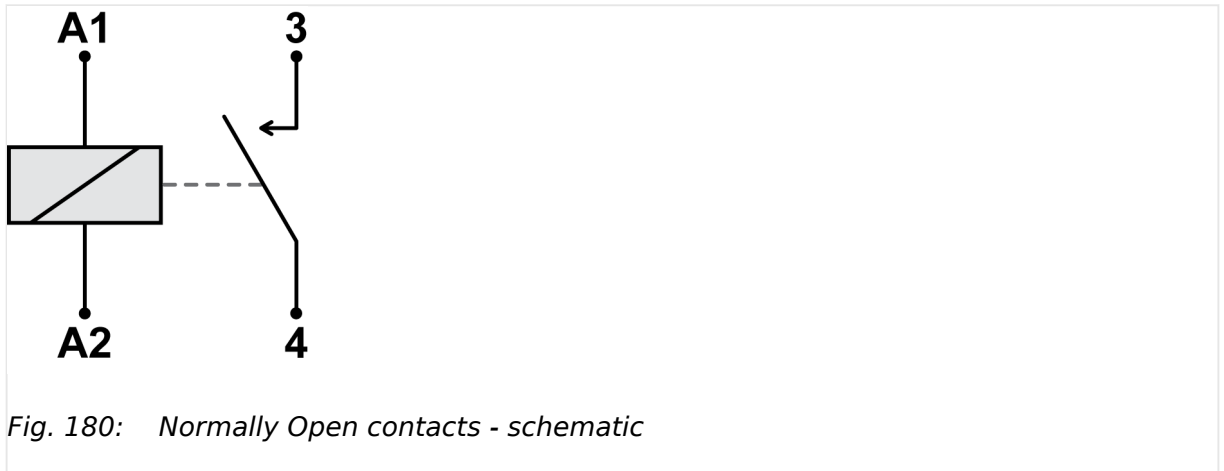

Normally Open (N.O.) contacts

The relay (discrete output) must be energized to close the contact.



Normally Closed (N.C.) contacts

The relay (discrete output) must be energized to open the contact.

ID	Parameter	CL	Setting range [Default]	Description
3474	GCB feedback handling	2	[GCB open] [GCB closed]	GCB open: Energized DI 8 indicates that the GCB is open.
				GCB closed: Energized DI 8 indicates that the GCB is closed.

4 Configuration

4.4.3.3 Configure Breakers: GCB

ID	Parameter	CL	Setting range [Default]	Description
3403	GCB open relay	2	[N.O.]	Normally open: The relay "command: GCB open" will be energized to open the GCB and will be de-energized again after the discrete input "Reply GCB" indicates the control that the GCB is open.
			N.C.	Normally closed: The relay "command: GCB open" will be de-energized to open the GCB and will be energized again after the discrete input "Reply GCB" indicates the control that the GCB is open.
			Not used	A GCB open relay is not used and relay R7 (Command: open GCB) is freely programmable. In this case, parameter ↩ 3414 must be configured to "Steady" to open the breaker.
				Notes This parameter only applies to application mode A02 to A13 .
3414	GCB close command	2	Impulse	The relay "Command: GCB close" issues an add-on pulse. If the relay is configured in this manner a holding coil and sealing contacts must be installed externally to the control unit. The DI "Reply GCB" is used to identify closed contacts.
			[Steady]	The relay "Command: close GCB" may be wired directly into the holding circuit for the power circuit breaker. If this method is utilized it is recommended that isolation relays are used. After the connect pulse has been issued and the reply of the power circuit breaker has been received, the relay "Command: close GCB" remains energized. If a class C alarm or higher occurs or a GCB open command is issued, this relay de-energizes.
				Notes In both cases the relay "Command: GCB open" energizes to open the GCB if parameter ↩ 3403 is not configured as "Not used". This parameter only applies to application modes A03 to A13 .
3416	GCB time pulse	2	0.10 to 1.00 s [0.50 s]	The time of the pulse output may be adjusted to the breaker being utilized.

ID	Parameter	CL	Setting range [Default]	Description
				<p>Notes</p> <p>This parameter only applies to application modes A03 to A13.</p>
5729	Synchronization GCB	2	[Slip frequency]	The frequency controller adjusts the frequency in a way, that the frequency of the source (generator) is marginal greater than the target (busbar). When the synchronizing conditions are reached, a close command will be issued. The slipping frequency depends on the setting of "Slip frequency offset" (parameter 5502).
			Phase matching	The frequency controller adjusts the phase angle of the source (generator) to that of the target (busbar), in view of turning the phase difference to zero.
				<p>Notes</p> <p>This parameter only applies to application modes A03 to A13.</p>
<p>Notes</p> <p>Regardless of breaker control, the values of 5700, 5701, 5702, 5703, 5704, 8824, and 8825 are important to the sync-check relay function.</p>				
5700	Voltage differential GCB	2	0.00 to 20.00% [5.00%]	<p>The maximum permissible voltage differential for closing the generator circuit breaker is configured here.</p> <p>If the difference between generator and busbar voltage does not exceed the value configured here and the generator voltage is within the operating voltage window (parameters 5800 and 5801), the "Command: GCB close" may be issued.</p> <p>Notes</p> <p>This value refers to the generator rated voltage (parameter 1766).</p> <p>This parameter only applies to application modes A03 to A13.</p>
5701	Pos. freq. differential GCB	2	0.00 to 0.49 Hz [+0.18 Hz]	<p>The prerequisite for a close command being issued for the GCB is that the differential frequency is below the configured differential frequency.</p> <p>This value specifies the upper frequency (positive value corresponds to positive slip → generator frequency is higher than the busbar frequency).</p>

ID	Parameter	CL	Setting range [Default]	Description
				<p>Notes</p> <p>This parameter only applies to application modes A03 to A13.</p>
5702	Neg. freq. differential GCB	2	-0.49 to 0.00 Hz [-0.10 Hz]	<p>The prerequisite for a close command being issued for the GCB is that the differential frequency is above the configured differential frequency.</p> <p>This value specifies the lower frequency limit (negative value corresponds to negative slip → generator frequency is less than the busbar frequency).</p> <p>Notes</p> <p>This parameter only applies to application modes A03 to A13.</p>
5703	Max. positive phase angle GCB	2	0.0 to 60.0° [7.0°]	<p>The prerequisite for a close command being issued for the GCB is that the leading phase angle between generator and busbar is below the configured maximum permissible angle.</p> <p>Notes</p> <p>This parameter only applies to application modes A03 to A13.</p> <p>This parameter is only displayed, if parameter ↔ 5729 is configured to "Phase matching".</p>
5704	Max. negative phase angle GCB	2	-60.0 to 0.0° [-7.0°]	<p>The prerequisite for a close command being issued for the GCB is that the lagging phase angle between generator and busbar is below the configured maximum permissible angle.</p> <p>Notes</p> <p>This parameter only applies to application modes A03 to A13.</p> <p>This parameter is only displayed, if parameter ↔ 5729 is configured to "Phase matching".</p>
5707	Phase matching GCB dwell time	2	0.0 to 60.0 s [3.0 s]	<p>This is the minimum time that the generator voltage, frequency, and phase angle must be within the configured limits before the breaker will be closed.</p> <p>Notes</p> <p>This parameter only applies to application modes A03 to A13.</p> <p>This parameter is only displayed, if parameter ↔ 5729 is configured to "Phase matching".</p>

ID	Parameter	CL	Setting range [Default]	Description
8825	Phase angle compensation GCB	3		The phase angle between generator voltage and generator busbar voltage can be compensated according to an installed power transformer between generator and busbar.
			On	The compensation is active. The phase will be compensated according the value configured in parameter ↪ 8824 .
			Notes	Measured values 181 'Ph.ang.busb1-gen.L12' and 184 'Ph.ang.mns.busb1 L12' are not changed but the compensated (↪ 8824) values are taken for synchronization control and synchroscope display.
			[Off]	The compensation is inactive. The phase angle is directly taken from the measurement.
				<p>Notes</p> <p>WARNING: Ensure the following parameters are configured correctly to prevent erroneous synchronization settings. Incorrect wiring of the system cannot be compensated for with this parameter!</p> <p>Please check during initial commissioning the phase angle and the synchronization with a zero voltmeter.</p> <p>Recommendation: For safety reasons, please mark the easYgen with a label showing the configured phase angle compensation.</p> <p>Refer to ↪ "6.3.12 Phase Angle Compensation" for details.</p>
8824	Phase angle GCB	3	-180 to 180° [0°]	<p>The phase angle compensation corrects the degree between generator voltage and busbar voltage. The configured degree is added to the real measured phase angle.</p> <p>Visible only, if parameter 8825 is "On".</p> <p>Notes</p> <p>Ensure correct configuration to prevent erroneous synchronization settings to avoid generator destructive power. Incorrect wiring cannot be compensated for with this parameter!</p>

ID	Parameter	CL	Setting range [Default]	Description
3432	Dead bus closure GCB	2	[On]	A dead busbar closure is allowed if the required conditions are met.
			Off	A GCB close command to a dead busbar is prevented. Synchronization is still possible.
			Notes This parameter only applies to application modes A03 to A13 . For more information about dead busbar closure/negotiation, see ↳ "4.4.3.1 Good to know: Actions with Breakers"	
3472	Dead bus closure multi segment	2	[On]	A dead busbar negotiation is done over all segments in the system.
			Off	A dead busbar negotiation is done only in the own segment.
			Notes This parameter only applies to application modes A03 to A13 . For more information about dead busbar closure/negotiation, see ↳ "4.4.3.1 Good to know: Actions with Breakers"	
15161	Inh.dead bus GCB	2	Determined by LogicsManager 87.74 [(0 & 1) & 1] = 11463	If active the dead bus closure of the GCB can be inhibited.
			Notes For information on the LogicsManager and its default settings see ↳ "9.3.1 LogicsManager Overview" .	
3415	Generator stable time	2	0 to 99 s [2 s]	<p>The time configured here begins to count down once the »Engine monitoring delay timer« ↳ 3315 has expired. This permits for an additional delay time before the breaker is closed in order to ensure that none of the engine delayed watchdogs trips.</p> <p>It is possible to bypass this delay time through the LogicsManager (parameter ↳ 12210) in the event an emergency operation condition (mains failure) occurs.</p> <p>Unnecessary CB switching operations and voltage interruptions should be avoided by utilizing this parameter.</p> <p>Notes This parameter only applies to application modes A03 to A12.</p>

ID	Parameter	CL	Setting range [Default]	Description
				After »Generator stable time« has expired, then "03.08 Break. delay expired" becomes TRUE.
12210	Undelay close GCB	2	Determined by LogicsManager 86.12 [(04.09 Emergency mode & 1) & 1] = 10711	<p>Once the conditions of the LogicsManager have been fulfilled the GCB will be closed immediately (without waiting for engine speed delay and generator stable timer to expire).</p> <p>When using the standard setting, the GCB will be closed without delay in emergency power operation.</p> <p>Notes</p> <p>This parameter only applies to application modes A03 to A13.</p> <p>Usually the dead busbar negotiation is started with reaching the generator frequency and voltage operating window. But during the function "undelayed close GCB", the dead busbar negotiation is executed from the moment on the engine has reached the firing speed.</p> <p><i>Through starting the dead bus bar negotiation earlier, the overall time before closing the GCB can be shorten.</i></p> <p>For information on the LogicsManager and its default settings see ↳ "9.3.1 LogicsManager Overview".</p>
12976	GCB open in MAN	2	Determined by LogicsManager 87.46 [(0 & 1) & 1] = 11435	<p>With the rising edge of this LogicsManager equation a GCB open command in operating mode MANUAL is initiated. The state TRUE of this LM inhibits the GCB close command in MANUAL.</p> <p>Notes</p> <p>This parameter only applies to application mode A03 to A13.</p> <p>For information on the LogicsManager and its default settings see ↳ "9.3.1 LogicsManager Overview".</p>
12977	GCB close in MAN	2	Determined by LogicsManager 87.47 [(0 & 1) & 1] = 11436	<p>With the rising edge of this LogicsManager equation a GCB close command in operating mode MANUAL is initiated. Precondition: deactivated "GCB open in MAN"</p> <p>Notes</p> <p>This parameter only applies to application mode A03 to A13.</p>

4 Configuration

4.4.3.3 Configure Breakers: GCB

ID	Parameter	CL	Setting range [Default]	Description
				For information on the LogicsManager and its default settings see ↪ "9.3.1 LogicsManager Overview" .
5705	Closing time GCB	2	40 to 300 ms [80 ms]	<p>The inherent closing time of the GCB corresponds to the lead-time of the close command.</p> <p>The close command will be issued independent of the differential frequency at the entered time before the synchronous point.</p> <p>Notes</p> <p>This parameter only applies to application modes A03 to A13.</p>
3405	GCB auto unlock	2		This is used for special circuit breakers to put the GCB into a defined initial state or to enable closing at all.
			Yes	Before every close-pulse, an open-pulse is issued for defined duration (parameter ↪ 5708 . A CB close pulse is enabled only after the open pulse is issued.
			[No]	The CB close pulse is enabled without being preceded by a CB open pulse.
				Notes
				This parameter only applies to application modes A03 to A13 .
5708	GCB open time pulse	2	1.00 to 10.00 s [1.00 s]	<p>This time defines the length of the GCB open time pulse, if the automatic switch unblocking GCB is activated.</p> <p>Notes</p> <p>This parameter only applies to application modes A03 to A13.</p>
12887	Enable GCB	2	Determined by LogicsManager 86.95 [(1 & 1) & 1] = 12051	<p>If active the closure of the GCB is enabled otherwise the GCB closure is disabled</p> <p>Notes</p> <p>Changing the state will cause an entry in the event list.</p> <p>If disabled, status "GCB closure disabled" alternating with "In operation" will be indicated.</p>
12886	Open GCB immediately	2	Determined by LogicsManager 86.51 [(0 & 1) & 1] = 12052	<p>Once the conditions of the LogicsManager have been fulfilled the GCB will be opened immediately.</p> <p>Notes</p>

ID	Parameter	CL	Setting range [Default]	Description
				The "Open GCB immediately" has a higher priority than the Enable GCB function and is valid for all application and operating modes.

4.4.3.4 Configure Breakers: GGB

General notes



All of the following Parameters only apply to the application modes:

A05, A06, A09, A10, A11 and A12

ID	Parameter	CL	Setting range [Default]	Description
3440	Min.Generator power	2	0.00 to 327.67 MW [0.10 MW]	<p>GGB operation - the GGB shall be closed when a minimum of generator rated power is available. Each easYgen adds the nominal power of all active running generators to determine the closing of the GGB.</p> <p>Notes</p> <p>This parameter only applies to application mode A05, A06, A09, A10, A11 and A12.</p>
12936	Bypass min. Pgen.	2	Determined by LogicsManager 87.29 = 11418	<p>This LogicsManager equation can bypass the considered minimal nominal generator power for closing the GGB.</p> <p>If the LogicsManager becomes TRUE the GGB will be closed independent of the current nominal generator power. According to the breaker transfer mode. Precondition: minimum one GGB is closed.</p> <p>Notes</p> <p>This parameter is valid for transition modes A05, A06, A09, A10, A11, and A12 now. On lower software versions (> SW 1.2100) this parameter only applied to application modes A05 and A06.</p> <p>For information on the LogicsManager and its default settings see "9.3.1 LogicsManager Overview".</p>
3475	GGB feedback handling	2	[GGB open]	Energized DI 9 indicates that the GGB is open.

4 Configuration

4.4.3.4 Configure Breakers: GGB

ID	Parameter	CL	Setting range [Default]	Description
			GGB closed	Energized DI 9 indicates that the GGB is closed.
3471	GGB open relay	2	[N.O.]	The relay "command: GGB open" will be energized to open the GGB and will be de-energized again after the discrete input "Reply GGB" is energized to signal the control that the GGB is open.
			Not used	The LogicsManager relay R11 is freely programmable. The configuration "04.25 Opening GGB active" works similar to the "N.O." logic.
5726	GGB time pulse	2	0.10 to 0.50 s [0.50 s]	The time of the pulse output may be adjusted to the breaker being utilized.
5731	Synchronization GGB	2	[Slip frequency]	The frequency controller adjusts the frequency in a way, that the frequency of the source (generator) is marginal greater than the target (load busbar). When the synchronizing conditions are reached, a close command will be issued. The slipping frequency depends on the setting of "Slip frequency offset" (parameter ↩ 5502).
			Phase matching	The frequency controller adjusts the phase angle of the source (generator) to that of the target (load busbar), in view of turning the phase difference to zero.
			Notes Please consider that the "Phase angle compensation MCB" (parameter ↩ 8841) influences the GGB synchronization as well. In both synchronisations the phase angle between generator busbar and mains is used. This parameter only applies to application mode A05 , A06 , A09 , A10 , A11 and A12 .	
				Notes Regardless of breaker control, the values of 5723, 5724, and 5720 are important to the sync-check relay function.
5720	Voltage differential GGB	2	0.50 to 20.00% [5.00%]	The maximum permissible voltage differential for closing the generator group breaker is configured here. If the difference between generator busbar and mains voltage does not exceed the value configured here and the mains voltage is within the operating voltage window (parameters ↩)

ID	Parameter	CL	Setting range [Default]	Description
				<p>5810 and ↩ 5811), the "Command: GGB close" may be issued.</p> <p>Notes</p> <p>This value refers to the generator rated voltage (parameter ↩ 1766) and mains rated voltage (parameter ↩ 1768).</p> <p>This parameter only applies to application mode A05, A06, A09, A10, A11 and A12.</p>
5721	Pos. freq. differential GGB	2	0.0 to 0.49 Hz [+0.18 Hz]	<p>The prerequisite for a close command being issued for the GGB is that the differential frequency is below the configured differential frequency.</p> <p>This value specifies the upper frequency (positive value corresponds to positive slip → generator frequency is higher than the load busbar frequency).</p> <p>Notes</p> <p>This parameter only applies to application mode A05, A06, A09, A10, A11 and A12.</p>
5722	Neg. freq. differential GGB	2	-0.49 to 0.00 Hz [-0.10 Hz]	<p>The prerequisite for a close command being issued for the GGB is that the differential frequency is above the configured differential frequency.</p> <p>This value specifies the lower frequency limit (negative value corresponds to negative slip → generator frequency is less than the load busbar frequency).</p> <p>Notes</p> <p>This parameter only applies to application mode A05, A06, A09, A10, A11 and A12.</p>
5723	Max. positive phase angle GGB	2	0.0 to 60.0° [7.0°]	<p>The prerequisite for a close command being issued for the GGB is that the leading phase angle between generator and load busbar is below the configured maximum permissible angle.</p> <p>Notes</p> <p>This parameter only applies to application mode A05, A06, A09, A10, A11 and A12.</p> <p>This parameter is only displayed, if parameter ↩ 5731 is configured to "Phase matching".</p>

ID	Parameter	CL	Setting range [Default]	Description
5724	Max. negative phase angle GGB	2	-60.0 to 0.0° [-7.0°]	The prerequisite for a close command being issued for the GGB is that the lagging phase angle between generator and load busbar is below the configured maximum permissible angle.
			Notes This parameter only applies to application mode A05 , A06 , A09 , A10 , A11 and A12 . This parameter is only displayed, if parameter 5731 is configured to "Phase matching".	
5727	Dwell time GGB	2	0.0 to 60.0 s [3.0 s]	This is the minimum time that the generator voltage, frequency, and phase angle must be within the configured limits before the breaker will be closed.
			Notes This parameter only applies to application mode A05 , A06 , A09 , A10 , A11 and A12 . This parameter is only displayed, if parameter 5731 is configured to "Phase matching".	
3422	GGB mode	2	[GGB open mode]	The GGB opens when the last GCB was opened.
			GGB close mode	The GGB is usually closed.
3445	Dead bus closure GGB	2	[On]	A dead busbar closure is allowed if the required conditions are met.
			Off	A GGB close command to a dead load busbar is prevented. Synchronization is still possible.
5725	Closing time GGB	2	40 to 300 ms [80 ms]	The inherent closing time of the GGB corresponds to the lead-time of the close command. The close command will be issued independent of the differential frequency at the entered time before the synchronous point.
			Notes This parameter only applies to application mode A05 , A06 , A09 , A10 , A11 and A12 .	
3441	Voltage monitoring load busbar	2		The decision to close the GGB or the MCB on a dead load busbar depends on the feedback of the GGB and MCB. To avoid damage because of a wrong breaker feedback the condition of the load busbar can additionally be monitored by a separate voltage relay.

ID	Parameter	CL	Setting range [Default]	Description
			On	The external load busbar voltage monitoring is enabled and the terminal 76 (input 10) expects a dead load busbar signal according to the breaker feedback GGB and MCB. The signal is usually provided by an external three phase voltage relay.
			[Off]	The external load busbar voltage monitoring is disabled and the terminal 76 (input 10) is free for other purposes.
3446	GGB auto unlock	2		This is used for special circuit breakers to put the GGB into a defined initial state or to enable closing at all.
			Yes	Before every close-pulse, an open-pulse is issued for defined duration (parameter ↩ 5719 . A CB close pulse is enabled only after the open pulse is issued.
			[No]	The CB close pulse is enabled without being preceded by a CB open pulse.
				Notes This parameter only applies to application mode A05 , A06 , A09 , A10 , A11 and A12 .
5719	GGB open time pulse	2	0.10 to 9.90 s [1.00 s]	This time defines the length of the GGB open time pulse, if the automatic switch unblocking GGB is activated.
				Notes This parameter only applies to application mode A05 , A06 , A09 , A10 , A11 and A12 .
12972	GGB open in MAN	2	Determined by LogicsManager 87.61 = 11450	With the rising edge of this LogicsManager equation a GGB open command in operating mode MANUAL is initiated. The state TRUE of this LM inhibits the GGB close command in MANUAL.
				Notes This parameter only applies to application mode A05 , A06 , A09 , A10 , A11 and A12 . For information on the LogicsManager and its default settings see ↩ "9.3.1 LogicsManager Overview" .
12973	GGB close in MAN	2	Determined by LogicsManager 87.62 = 11451	With the rising edge of this LogicsManager equation a GGB close command in operating mode MANUAL is initiated. Precondition: deactivated "GGB open in MAN"

ID	Parameter	CL	Setting range [Default]	Description
				<p>Notes</p> <p>This parameter only applies to application mode A05, A06, A09, A10, A11 and A12.</p> <p>For information on the LogicsManager and its default settings see ↪ "9.3.1 LogicsManager Overview".</p>
12948	Enable GGB	2	Determined by LogicsManager 87.37 [(Not 04.02 Operat. mode STOP & 1) & 1] = 11426	If active the closure of the GGB is enabled otherwise the GGB closure is disabled <p>Notes</p> <p>Changing the state will cause an entry in the event list.</p> <p>If disabled, status "GGB closure disabled" will be indicated.</p>
12947	Open GGB immediately	2	Determined by LogicsManager 87.36 [(0 & 1) & 1] = 11425	Once the conditions of the LogicsManager have been fulfilled the GGB will be opened immediately. <p>Notes</p> <p>The "Open GGB immediately" has a higher priority than the Enable GGB function and is valid for all application and operating modes.</p>



4.4.3.5 Configure Breakers: MCB

General notes



The following parameters are **only** applicable for application modes **A04**, **A06**, **A08**, **A09**, **A11** and **A12**.

ID	Parameter	CL	Setting range [Default]	Description
3476	MCB feedback handling	2	[MCB open] [MCB closed]	MCB open: Energized DI 7 indicates that the MCB is open. MCB closed: Energized DI 7 indicates that the MCB is closed.
3398	MCB open relay	2	[N.O.]	The relay "command: MCB open" will be energized to open the MCB and will be de-energized again after the discrete input "Reply

ID	Parameter	CL	Setting range [Default]	Description
				MCB" is energized to signal the control that the MCB is open.
			Not used	The LogicsManager relay R9 is freely programmable. The pre-configuration "04.22 Opening MCB active" works similar to the "N.O." logic.
3417	MCB time pulse	2	0.10 to 0.50 s [0.50 s]	Breaker pulse duration to close the MCB The time of the pulse output may be adjusted to the breaker being utilized.
5730	Synchronization MCB	2	[Slip frequency]	The frequency controller adjusts the frequency in a way, that the frequency of the source (busbar) is marginal greater than the target (mains). When the synchronizing conditions are reached, a close command will be issued. The slipping frequency is positive to avoid reverse power.
			Phase matching	The frequency controller adjusts the phase angle of the source (busbar) to that of the target (mains), in view of turning the phase difference to zero.
Notes				
Regardless of breaker control, the values of the following parameters 5710, 5711, 5712, 5713, 5714, 8841, and 8842 are important to the sync-check relay function.				
5713	Max. positive phase angle MCB (Maximum permissible positive phase angle MCB)	2	0.0 to 60.0° [7.0°]	The prerequisite for a connect command being issued for the MCB is that the leading phase angle between busbar and mains is below the configured maximum permissible angle. Notes This parameter is only displayed, if parameter  5730 is configured to "Phase matching". This parameter only applies to application mode A04 and A06 .
5714	Max. negative phase angle MCB (Maximum permissible negative phase angle MCB)	2	-60.0 to 0.0° [-7.0°]	The prerequisite for a connect command being issued for the MCB is that the lagging phase angle between busbar and mains is below the configured maximum permissible angle. Notes This parameter is only displayed, if parameter  5730 is configured to "Phase matching". This parameter only applies to application mode A04 and A06 .

4 Configuration

4.4.3.5 Configure Breakers: MCB

ID	Parameter	CL	Setting range [Default]	Description
5710	Voltage differential MCB	2	0.00 to 20.00% [5.00%]	<p>The maximum permissible voltage differential for closing the mains circuit breaker is configured here.</p> <p>Notes</p> <p>This value refers to the generator rated voltage (parameter ↩ 1766) and mains rated voltage (parameter ↩ 1768).</p> <p>If the difference between mains and busbar voltage does not exceed the value configured here and the mains voltage is within the operating voltage window (parameters ↩ 5810 and ↩ 5811), the "Command: MCB close" may be issued.</p> <p>This parameter only applies to application mode A04 and A06.</p>
5711	Pos. freq. differential MCB (Positive frequency differential MCB)	2	0.02 to 0.49 Hz [0.18 Hz]	<p>The prerequisite for a connect command being issued for the MCB is that the differential frequency is below the configured differential frequency.</p> <p>This value specifies the upper frequency (positive value corresponds to positive slip → busbar frequency is higher than the mains frequency).</p> <p>Notes</p> <p>This parameter only applies to application mode A04 and A06.</p>
5712	Neg. freq. differential MCB (Negative frequency differential MCB)	2	-0.49 to 0.00 Hz [-0.10 Hz]	<p>The prerequisite for a connect command being issued for the MCB is that the differential frequency is above the configured differential frequency.</p> <p>This value specifies the lower frequency limit (negative value corresponds to negative slip → busbar frequency is less than the mains frequency).</p> <p>Notes</p> <p>This parameter only applies to application mode A04 and A06.</p>
5709	MCB sync. with separate slip	2	On	<p>The MCB is synchronized with an individual slip frequency (also negative).</p> <p>Notes</p> <p>The setting for the slipping frequency (parameter ↩ 5647) via display is located under 'configure frequency control'.</p>

ID	Parameter	CL	Setting range [Default]	Description
			[Off]	The MCB is synchronized with the same slip frequency like the GCB (parameter ↩ 5502).
				Notes This parameter only applies to application mode A04 and A06 .
5647	MCB slip freq. setpoint offset	2	-0.50 ... 0...50 Hz [-0.10 Hz]	Individual frequency offset for the MCB and LS5 synchronization. This value can be a positive or negative offset. The value is valid as long as the parameter 'MCB synchronization with separate slip On/Off' (parameter ↩ 5709) is set to 'On'.
8841	Phase angle compensation MCB	23		The phase angle between busbar voltage and mains voltage can be compensated according to an installed power transformer between busbar and mains.
			On	The compensation is active. The phase will be compensated according the value configured in parameter ↩ 8842 . Notes Measured values 181 'Ph.ang.busb1-gen.L12' and 184 'Ph.ang.mns.busb1 L12' are not changed but the compensated (↩ 8842) values are taken for synchronization control and synchroscope display.
			[Off]	The compensation is inactive. The phase angle is directly taken from the measurement.
				Notes WARNING: Ensure the following parameters are configured correctly to prevent erroneous synchronization settings. Incorrect wiring of the system cannot be compensated for with this parameter! Please check during initial commissioning the phase angle and the synchronization with a zero voltmeter. Recommendation: For safety reasons, please mark the easYgen with a label showing the configured phase angle compensation. Refer to ↩ "6.3.12 Phase Angle Compensation" for details. This parameter only applies to application mode A04 and A06 .

ID	Parameter	CL	Setting range [Default]	Description
8842	Phase angle MCB	3	-180 to 180° [0°]	<p>The phase angle compensation corrects the degree between busbar voltage and mains voltage. The configured degree is added to the real measured phase angle.</p> <p>Notes</p> <p>This parameter only applies to application mode A04 and A06.</p> <p>Ensure correct configuration to prevent erroneous synchronization settings to avoid generator destructive power. Incorrect wiring cannot be compensated for with this parameter!</p>
5717	Phase matching MCB dwell time	2	0.0 to 60.0 s [3.0 s]	<p>This is the minimum time that the generator/busbar voltage, frequency, and phase angle must be within the configured limits before the breaker will be closed.</p> <p>Notes</p> <p>This parameter is only displayed, if parameter  5730 is configured to "Phase matching".</p> <p>This parameter only applies to application mode A04 and A06.</p>
3431	Dead bus closure MCB	2	[On]	A dead busbar closure is allowed if the required conditions are met.
			Off	An MCB close command to a dead busbar is prevented. Synchronization is still possible.
			Notes	This parameter only applies to application mode A04 , A06 , A08 , A09 , A11 , and A12 .
5715	Closing time MCB	2	40 to 300 ms [80 ms]	<p>The inherent closing time of the MCB corresponds to the lead-time of the close command.</p> <p>The close command will be issued independent of the differential frequency at the entered time before the synchronous point.</p> <p>Notes</p> <p>This parameter only applies to application mode A04 and A06.</p>
3407	MCB auto unlock	2		This is used for special circuit breakers to put the MCB into a defined initial state or to enable closing at all.
			Yes	Before every close-pulse, an open-pulse is issued for defined duration (parameter  5718. A

ID	Parameter	CL	Setting range [Default]	Description
				CB close pulse is enabled only after the open pulse is issued.
			[No]	The CB close pulse is enabled without being preceded by a CB open pulse.
				Notes This parameter only applies to application mode A04 and A06 .
12923	Enable MCB	2	Determined by LogicsManager 86.85 [(09.06 Discrete input 6 & ! 08.07 MCB fail to close) & ! 07.05 Mns.ph.rot. mismatch] = 11914	Once the conditions of the LogicsManager have been fulfilled the closure of the MCB will be enabled. Notes DI 6 is pre-assigned by default to this function, but may be configured freely. For information on the LogicsManager and its default settings see ↪ "9.3.1 LogicsManager Overview" . This parameter only applies to application mode A04 , A06 , A08 , A09 , A11 , and A12 .
5718	MCB open time pulse	2	0.10 to 9.90 s [1.00 s]	This time defines the length of the MCB open time pulse, if the automatic switch unblocking MCB is activated. Notes This parameter only applies to application mode A04 and A06 .
12974	MCB open in MAN	2	Determined by LogicsManager 87.48 [(0 & 1) & 1] = 11437	With the rising edge of this LogicsManager equation a MCB open command in operating mode MANUAL is initiated. The state TRUE of this LM inhibits the MCB close command in MANUAL. Notes This parameter only applies to application mode A04 , A06 , A08 , A09 , A11 , and A12 . For information on the LogicsManager and its default settings see ↪ "9.3.1 LogicsManager Overview" .
12975	MCB close in MAN	2	Determined by LogicsManager 87.49 [(0 & 1) & 1] = 11438	With the rising edge of this LogicsManager equation a MCB close command in operating mode MANUAL is initiated. Precondition: deactivated "MCB open in MAN" Notes

ID	Parameter	CL	Setting range [Default]	Description
				<p>This parameter only applies to application mode A04, A06, A08, A09, A11, and A12.</p> <p>For information on the LogicsManager and its default settings see 9.3.1 LogicsManager Overview.</p>

4.4.3.6 Configure Breakers: Synchronization

General notes



The following parameters are **only** applicable for application modes **A03** to **A13**

ID	Parameter	CL	Setting range [Default]	Description
5728	Synchronization mode	2	Off	<p>The synchronization is disabled; the frequency and voltage adaptation for synchronization is not active.</p> <p>In operation mode AUTO the easYgen allows the external GCB closing in synchronization mode "Off" if:</p> <ul style="list-style-type: none"> Start request in automatic active Generator is in operating range The engine start procedure is finished <p>In operation mode AUTO the easYgen allows the external MCB closing in synchronization mode "Off" if:</p> <ul style="list-style-type: none"> Mains is in the operating range <p>In operation mode AUTO the easYgen allows the external GGB closing in synchronization mode "Off" if:</p> <ul style="list-style-type: none"> Minimum 1 GCB is closed
			PERMISSIVE	<p>The unit acts as a synch check device. The unit will not issue speed or voltage bias commands to achieve a synchronization, but if phase matching synchronization conditions are matched (frequency, phase, voltage and</p>

ID	Parameter	CL	Setting range [Default]	Description
				<p>phase angle), the control will issue a breaker close command.</p> <p>There are two different functionalities of this option depending on the setting of parameter ↗ 3414 (GCB close command).</p> <ul style="list-style-type: none"> GCB close command set to "Impulse": The GCB close command is pulsed as long as the synchronization conditions are matched. GCB close command set to "Steady": The GCB close command remains enabled as long as the synchronization conditions are matched.
			CHECK	<p>Used for checking a synchronizer prior to commissioning.</p> <p>The control actively synchronizes generator(s) by issuing speed and voltage bias commands, but does not issue a breaker closure command for synchronizing.</p>
			[RUN]	<p>Normal operating mode. The control actively synchronizes and issues breaker closure commands.</p>
			Controlled by LM	<p>The synchronization mode may be selected by enabling one of the respective LogicsManager functions (parameters ↗ 12907, ↗ 12906, or ↗ 12908).</p> <p>If none of these parameters is enabled, the synchronization is disabled.</p> <p>If more than one of these parameters is enabled, the following priority is valid:</p> <ul style="list-style-type: none"> 1. PERMISSIVE 2. CHECK 3. RUN
				<p>Notes</p> <p>The device will still perform a dead busbar closure if the conditions are valid.</p>
12907	<p>Syn. mode PERMIS. (Synchronization mode PERMISSIVE)</p>	2	<p>Determined by LogicsManager 86.39</p> <p>[(0 & 1) & 1]</p> <p>= 11618</p>	<p>Once the conditions of the LogicsManager have been fulfilled the PERMISSIVE synchronization mode will be enabled.</p> <p>Notes</p>

ID	Parameter	CL	Setting range [Default]	Description
				For information on the LogicsManager and its default settings see ↪ "9.3.1 LogicsManager Overview" .
12906	Syn. mode CHECK (Synchronization mode CHECK)	2	Determined by LogicsManager 86.38 [(0 & 1) & 1] = 11617	Once the conditions of the LogicsManager have been fulfilled the CHECK synchronization mode will be enabled. Notes For information on the LogicsManager and its default settings see ↪ "9.3.1 LogicsManager Overview" .
12908	Syn. mode RUN (Synchronization mode RUN)	2	Determined by LogicsManager 86.40 [(0 & 1) & 1] = 11619	Once the conditions of the LogicsManager have been fulfilled the RUN synchronization mode will be enabled. Notes For information on the LogicsManager and its default settings see ↪ "9.3.1 LogicsManager Overview" .
15157	Synchroscope autom. to front (Synchroscope automatic to front)	2	On	The synchroscope screen automatically appears on the main screen, when the synchronization becomes active.
			[Off]	Functionality deactivated.

4.4.3.6.1 Independent Sync. Check Function

General notes

The device provides two independent "Sync Check" functions for the voltage comparisons generator to busbar and busbar to mains. The criteria are the same like for the according internal self-executed synchronization.

The easYgen provides two command variables available for the LogicsManager input:

- 02.29 Sync.Check gen./busb
- 02.32 Sync.Check mns/busb

WARNING!



No dead bus interlocking

Synch. Check is intended to be a redundant check function enhancing system security.
Don't use for MCB control!



The Sync. Check functionality is available in every application mode. The command variables are independently calculated and depending on the same configurations, like the self-executed GCB and MCB close commands. The sync. Check function has no influence on any frequency or voltage biasing. There is no relationship to the Sync. Check mode for the internal self-executed synchronization.



The Synchron. Check command variables do not care about:

- Possible dead busbar closure capabilities
- Internally calculated self-executed circuit breaker close orders
- Synchronization control conditions, like »mains settling time «

Variables and Parameters

»02.29 Sync.Check gen./busb« depends on

- Voltage
 - Frequency
- and
- Phase angle

The command variable »02.29 Sync.Check gen./busb« is true if the synchronization conditions are matched according to (GCB) parameters:

- 5701: Pos. freq. differential
- 5702: Neg. freq. differential
- 5700: Voltage differential
- 8825, 8824: Phase angle compensation
- 5703: Max. positive phase angle
- 5704: Max. negative phase angle GCB

»02.32 Sync.Check mns/busb« depends on

- Voltage
 - Frequency
- and
- Phase angle

The command variable »02.32 Sync.Check mns/busb« is true, if the synchronization conditions are matched according to parameters:

- 5711: Pos. freq. differential MCB
- 5712: Neg. freq. differential MCB
- 5710: Voltage differential MCB

- 8841,8842: Phase angle compensation MCB
- 5713: Max. positive phase angle MCB
- 5714: Max. negative phase angle MCB

4.4.3.7 Configure Breakers: Neutral Interlocking

General Notes

The Neutral Interlocking feature controls a Neutral Contactor (NC) of each generator. The rule is that only one neutral contactor of all running generators are closed. The Logic ensures that with changing of generators the neutral link is passed over to another running generator. Refer to [6.3.15 Neutral Interlocking](#) for more information.

ID	Parameter	CL	Setting range [Default]	Description
1840	Neutral Interlocking	2	On	Neutral interlocking is enabled. The command variable "03.39 Close neutral cont." is activated and the DI 12 is used for the NC feedback. The unit monitors the NC feedback according to the close order.
			[Off]	Neutral interlocking is disabled. The NC monitoring is disabled.
1841	Priority	2	1 ... 32 [1]	The priority determines which NC is closed, if multiple gens are running in the same segment.
			Notes	The lower the configured number, the higher the priority



To make use of the Close neutral interlocking contactor status, configure a discrete output relay DO x to react for 03.39.

4.4.4 Configure Controller

WARNING!



Hazards due to incorrect settings

The following parameters dictate how the easYgen controls voltage, frequency, load and power factor.

Failure to do so may lead to incorrect measurements and failures within the control unit resulting in damage to or destruction of the generator and/or personal injury or death.

- Always ensure that the correct settings are entered in these parameters.

The Real load, reactive load, and process control all utilize PID controllers. The response of each control loop can be adjusted for optimum response, however it is important to understand what a PID controller is and the effect of each controller adjustment has on the controller response.

Proportional gain, integral gain (stability) and DR (speed derivative ratio) are the adjustable and interacting parameters used to match the response of the control loop with the response of the system.

They correspond to the P (proportional), I (integral), and D (derivative) terms, and are displayed in the easYgen as follows:

P	Proportional gain (%)
I	Integral gain (%)
D	Derivative gain (determined by DR and I)

Proportional control

Proportional response is directly proportional to a process change.

- Analogy: Setting hand throttle to keep constant speed on straight and level road.

Proportional control (using the same analogy) results in a certain speed as long as the car is not subjected to any load change such as a hill. If a throttle is set to any particular setting, the speed of the car will remain constant as long as the car remains straight and level. If the car goes up a hill it will slow down. Of course, going down a hill the car would gain speed.



There is a special handling from the control loop if the "**Integral gain**" is configured to "**0.00**".

In that case only the **Proportional control** is active and the response depends from difference between "setpoint" and "actual value" with the configured "Proportional gain".

Integral control

Integral compensates for process and setpoint load changes.

- Analogy: Cruise control maintains constant speed regardless of hills.

Integral, sometimes called reset, provides additional action to the original proportional response as long as the process variable remains away from the setpoint. Integral is a function of the magnitude and duration of the deviation. In this analogy the reset response would keep the car speed constant regardless of the terrain.

Derivative

Derivative provides a temporary over-correction to compensate for long transfer lags and reduce stabilization time on process upsets (momentary disturbances). The behavior of the derivative parameter is shown in [Fig. 182](#).

- Analogy: Accelerating into high speed lane with merging traffic.

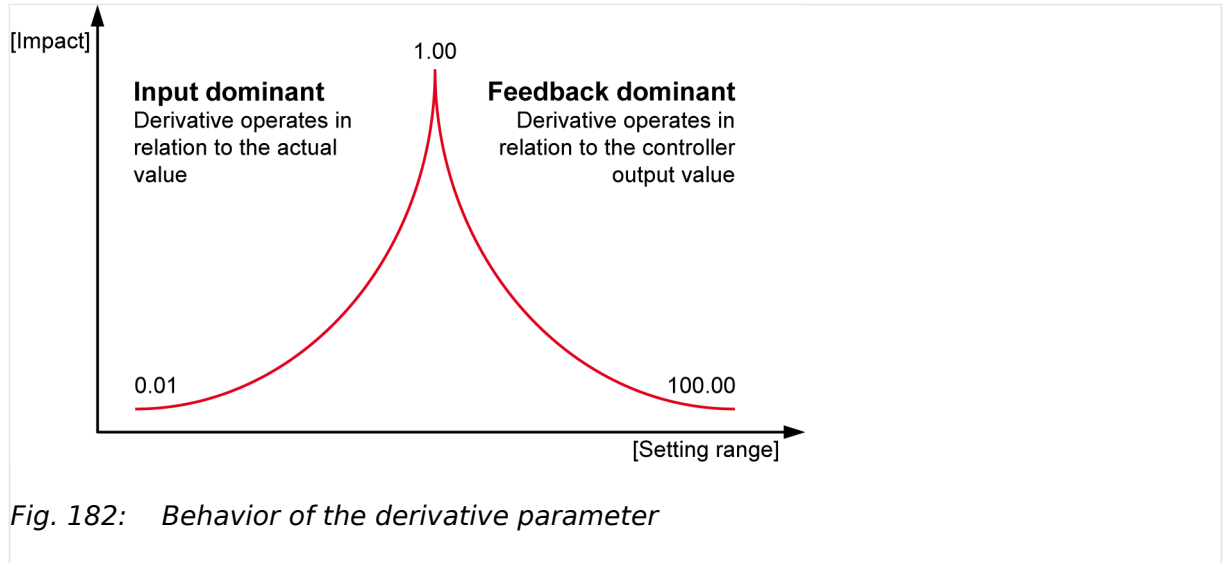

Fig. 182: Behavior of the derivative parameter

Derivative, sometimes called "preact" or "rate", is very difficult to draw an accurate analogy to, because the action takes place only when the process changes and is directly related to the speed at which the process changes.

Merging into high speed traffic of a freeway from an "on" ramp is no easy task and requires accelerated correction (temporary overcorrection) in both increasing and decreasing directions. The application of brakes to fall behind the car in the first continuous lane or passing gear to get ahead of the car in the first continuous lane is a derivative action.

PID tuning example

If the system is unstable, make sure the governor is the cause. This can be checked by closing the valve limiter until it has control of the actuator output. If the governor is causing the oscillation, time the oscillation cycle time. A rule-of-thumb is, if the system's oscillation cycle time is less than 1 second, reduce the Proportional gain term. A rule-of-thumb is, if the system's oscillation cycle time is greater than 1 second, reduce the Integral gain term (proportional gain may need to be increased also).

On an initial startup with the easYgen, all PID dynamic gain terms will require adjustment to match the respective PID's response to that of its control loop. There are multiple dynamic tuning methods available that can be used with the easYgen's PIDs to assist in determining the gain terms that provide optimum control loop response times.



> The following method can be used to achieve PID gain values that are close to optimum:

1. ▷ Increase Derivative Ratio (DR) to 100.
2. ▷ Reduce integral gain to 0.01.
3. ▷ Increase proportional gain until system just starts to oscillate.



The optimum gain for this step is when the system just starts to oscillate and maintains a self-sustaining oscillation that does not increase or decrease in magnitude.

4. ▷ Record the control gain (K_c) and oscillation period (T) in seconds.
5. ▷ Set the dynamics as follows:
 - For PI control $G=P(I/s + 1)$ set:
 - Proportional gain = $0.45 \cdot K_c$
 - Integral gain = $1.2/T$
 - Derivative ratio = 100
 - For PID control $G=P(I/s + 1 + Ds)$ set:
 - Proportional gain = $0.60 \cdot K_c$
 - Integral gain = $2/T$
 - Deriv ratio = $8/(T \cdot \text{Integral Gain})$ for feedback dominant
 - Deriv ratio = $(T \cdot \text{Integral Gain})/8$ for input dominant

- ▶ This method of tuning will get the gain settings close, they can be fine-tuned from this point.

4.4.4.1 Voltage Control



ToolKit: find settings screen

[Parameter / Configuration / Configure application / Configure controller / Configure voltage control]

AnalogManagers to define input signal of voltage setpoint (1, 2) are available in ToolKit by

- a click from screen/page "Configure voltage control"
 - on the button "Analog manager" in the left sidebar (below permanent buttons) or
 - on two times "next page", or
- search for one of the AnalogManagers [↗ 5618](#)/[↗ 5619](#)



ToolKit: Trend chart

ToolKit offers a trend visualization accessible by

- a click from screen/page "Configure voltage control"
 - on the button "Trend chart" in the left sidebar (below permanent buttons) or
 - on "next page", or
- search for one of the voltage controlled value shown at the status screen

4 Configuration

4.4.4.1 Voltage Control

ID	Parameter	CL	Setting range [Default]	Description
5607	Voltage control	2	Off	Voltage control is not carried out.
			[PID analog]	The voltage is controlled using an analog PID controller.
			3pos controller	The voltage is controlled using a three-step controller.
			AVR Note: (Accessible only in easYgen 3400XT/3500XT)	The voltage is controlled by using an internal AVR algorithm acting on the "easYgen exciter-10" (EX-10) or AVRbridge-10-P1 module. Note: With enabling the AVR function the power factor control (kvar control) is provided as well over this algorithm. The setting 5625 Power factor control is faded out.
5608	Voltage control initial state	2	0.0 to 100.0% [50.0%]	The value entered for this parameter is the start reference point for the analog output to the voltage controller. If the output to the voltage control has been disabled, the output will act as a control position reference point.
5610	Proportional gain	2	0.01 to 100.00 [1.00]	The proportional coefficient specifies the gain. By increasing the gain, the response is increased to permit larger corrections to the variable to be controlled. The farther out of tolerance the process is the larger the response action is to return the process to the tolerance band. If the gain is configured too high, the result is excessive overshoot/undershoot of the desired value. Notes This parameter is only visible if voltage control (parameter 5607) is configured to "PID analog".
5611	Integral gain	2	0.01 to 100.00 [1.00]	The integral gain identifies the I part of the PID controller. The integral gain corrects for any offset (between setpoint and process variable) automatically over time by shifting the proportioning band. Reset automatically changes the output requirements until the process variable and the setpoint are the same. This parameter permits the user to adjust how quickly the reset attempts to correct for any offset. The integral gain constant must be greater than the derivative time constant. If the integral gain constant is too large, the engine will continually oscillate. If the integral gain

ID	Parameter	CL	Setting range [Default]	Description
				<p>constant is too small, the engine will take too long to settle at a steady state.</p> <p>Notes</p> <p>This parameter is only visible if voltage control (parameter 5607) is configured to "PID analog".</p>
5612	Derivative ratio	2	0.01 to 100.00 [0.01]	<p>The derivative ratio identifies the D part of the PID controller. By increasing this parameter, the stability of the system is increased.</p> <p>The controller will attempt to slow down the action of the actuator in an attempt to prevent excessive overshoot or undershoot.</p> <p>Essentially this is the brake for the process. This portion of the PID loop operates anywhere within the range of the process unlike reset.</p> <p>Notes</p> <p>This parameter is only visible if voltage control (parameter 5607) is configured to "PID analog".</p> <p>The default configured controller acts like a PI controller what is the valid D part setting for systems with secondary controllers.</p>
5650	Deadband	1	0.1 to 9.9% [1.0%]	<p>islanded operation</p> <p>The generator voltage is controlled in such a manner that the measured voltage does not deviate from the configured setpoint by more than the value configured in this parameter without the controller issuing a voltage raise/lower signal to the voltage regulator. This prevents unneeded wear on the voltage bias output control or the raise/lower relay contacts.</p> <p>Synchronization</p> <p>The generator voltage is controlled in such a manner that the measured voltage does not deviate from the monitored reference (mains or busbar) voltage by more than the value configured in this parameter without the controller issuing a voltage raise/lower signal to the voltage regulator.</p> <p>This prevents unneeded wear on the voltage bias output control or the raise/lower relay contacts. The</p>

4 Configuration

4.4.4.1 Voltage Control

ID	Parameter	CL	Setting range [Default]	Description
				<p>value configured for this parameter must be less than the value configured for the dV max (maximum voltage differential) for synchronization (parameters ↩→ 5700 or ↩→ 5710).</p> <p>Notes</p> <p>This parameter is only visible if voltage control (parameter ↩→ 5607) is configured to "3pos controller".</p>
5651	Time pulse minimum	1	0.01 to 2.00 s [0.05 s]	<p>A minimum pulse on time must be configured here. The shortest possible pulse time should be configured to limit overshoot of the desired voltage reference point.</p> <p>Notes</p> <p>This parameter is only visible if voltage control (parameter ↩→ 5607) is configured to "3pos controller".</p>
5652	Gain factor	1	0.1 to 10.0 [5.0]	<p>The gain factor Kp influences the operating time of the relays. By increasing the number configured in this parameter, the operating time of the relay will be in-creased in response to a deviation from the voltage reference.</p> <p>By increasing the gain, the response is increased to permit larger corrections to the variable to be controlled.</p> <p>The farther out of tolerance the process is the larger the response action is to return the process to the tolerance band. If the gain is configured too high, the result is excessive overshoot/undershoot of the desired value.</p> <p>Notes</p> <p>This parameter is only visible if voltage control (parameter ↩→ 5607) is configured to "3pos controller".</p>
5659	Cycle time factor	1	1.0 to 20.0 [1.0]	<p>The cycle time factor adjusts the time between the pulses (pause time).</p> <p>By increasing the cycle time factor, the time between the pulses increases.</p> <p>Notes</p> <p>This parameter is only visible if voltage control (parameter ↩→</p>

ID	Parameter	CL	Setting range [Default]	Description
				5607) is configured to "3pos controller".
5653	Expand deadband factor	1	1.0 to 9.9 [1.0]	<p>If the measured generator voltage is within the deadband range (parameter ↩ 5650) and the configured delay expand deadband time (parameter ↩ 5654) expires, the deadband will be multiplied with the factor configured here.</p> <p>Notes</p> <p>This parameter is only visible if voltage control (parameter ↩ 5607) is configured to "3pos controller".</p>
5654	Delay expand deadband	1	1.0 to 9.9 s [2.0 s]	<p>The measured generator voltage must be within the deadband range for the time configured here in order to multiply the deadband with the factor configured in parameter ↩ 5653.</p> <p>Notes</p> <p>This parameter is only visible if voltage control (parameter ↩ 5607) is configured to "3pos controller".</p>
5618	AM Voltage SP1 [V]	2	Determined by AnalogManager 81.09 [A1 = 05.57 Internal v setp1 [V]]	<p>The voltage setpoint 1 source may be selected from the available data sources.</p> <p>The internal voltage setpoint 05.57 can be changed manually at the setpoint screen of the display.</p> <p>Notes</p> <p>The voltage setpoint may be adjusted within the configured operating limits (↩ "4.5.1.1 Generator Operating Ranges: Voltage / Frequency / Busbar").</p>
5600	Int.voltage control setpoint 1	2	50 to 650,000 V [400 V]	<p>The internal generator voltage setpoint 1 is defined in this screen. This value is the reference for the voltage controller when performing islanded and/or no-load operations.</p>
5619	AM Voltage SP2 [V]	2	Determined by AnalogManager 81.10 [A1 = 05.58 Internal v setp2 [V]]	<p>The voltage setpoint 2 source may be selected from the available data sources.</p> <p>The internal voltage setpoint 05.58 can be changed manually at the setpoint screen of the display.</p> <p>Notes</p> <p>The voltage setpoint may be adjusted within the configured operating limits (↩ "4.5.1.1</p>

4 Configuration

4.4.4.1 Voltage Control

ID	Parameter	CL	Setting range [Default]	Description
				Generator Operating Ranges: Voltage / Frequency / Busbar").
5601	Int.voltage control setpoint 2	2	50 to 650,000 V [400 V]	The internal generator voltage setpoint 2 is defined in this screen. This value is the reference for the voltage controller when performing islanded and/or no-load operations.
4555	Volt.filter time const.control	2	0.0 to 99.9 s [0.0 s]	<p>The PT1-filter for the actual generator voltage value can be configured here. The parameter stands for the 3 times tau value of a PT1 element. That means the configured time defines when 95% of the original value jump is reached. The filtered value is used as input to the controller.</p> <p>Notes</p> <p>The actual generator voltage which is used as filter source (VL12, VL1N or VL31), depends on ↪ 1851.</p> <p>Input 0.0 s disables the filter influence.</p>
12920	Setp. 2 voltage	2	Determined by LogicsManager 86.83 [(0 & 1) & 1] = 11912	<p>If this LogicsManager condition is TRUE, the voltage setpoint 2 will be used instead of voltage setpoint 1. The voltage (result of AM) ↪ 5619 instead of ↪ 5618 will be taken into account.</p> <p>Notes</p> <p>For information on the LogicsManager and its default settings see ↪ "9.3.1 LogicsManager Overview".</p> <p>Remotely switching the setpoint is possible: Use the LogicsManager command variable for input that is correlating with the dedicated bit of parameter ↪ 1851.</p>
5616	Start value	1	0 to 100% [70%]	<p>The voltage controller is activated when the monitored generator voltage has exceeded the value configured in this parameter. This prevents the easYgen from attempting to control the voltage while the engine is completing its start sequence.</p> <p>Notes</p> <p>This value refers to the generator voltage setpoint (parameter ↪ 5600 or ↪ 5601).</p>
5617	Start delay	1	0 to 999 s [5 s]	The voltage controller is enabled after the configured time for this parameter expires.

ID	Parameter	CL	Setting range [Default]	Description
5603	Voltage control setpoint ramp	2	1.00 to 300.00 %/s [5.00 %/s]	The different setpoint values are supplied to the controller via this ramp. The slope of the ramp is used to alter the rate at which the controller modifies the setpoint value. The faster the change in the setpoint is to be carried out, the greater the value entered here must be.
5604	Voltage control droop	2	0.0 to 20.0% [5.0%]	If this control is to be operated on a generator in parallel with other generators and voltage control is enabled, a droop characteristic curve must be used. Each generator in the system will require the same value to be configured for the droop characteristic, so that when the system is stable the reactive power will be distributed proportionally among all generators in relation to their rated reactive power.
12905	Volt. droop act. (Voltage droop active)	2	Determined by LogicsManager 86.26 [(08.17 Missing members OR 08.06 GCB fail to open08.06 GCB fail to open) & 1] = 11605	If this LogicsManager condition is TRUE, the voltage droop is enabled. Example <ul style="list-style-type: none"> Rated reactive power: 400 kvar Rated voltage setpoint: 410 V Droop 5.0% Reactive power 0 kvar = 0% of rated power Voltage is adjusted to (410 V - [5.0% * 0.0 * 410 V]) = 410 V. Reactive power 400 kvar = 100% of rated reactive power Voltage is adjusted to (410 V - [5.0% * 1.0 * 410 V]) = 410 V - 20.5 V = 389.5 V. Notes For information on the LogicsManager and its default settings see 9.3.1 LogicsManager Overview .
12938	Release V-control	2	Determined by LogicsManager 86.97 [(1 & 1) & 1] = 11926	This LogicsManager is used to activate generally the voltage biasing to the sub controller. If the LogicsManager is false the output will be on the initial state (see parameter 5608). The LogicsManager condition status 'TRUE' is activating the voltage or reactive power regulation according to the

ID	Parameter	CL	Setting range [Default]	Description
				LogicsManager 'V/Q control' ID (➤ 12941). Notes For information on the LogicsManager and its default settings see ➤ "9.3.1 LogicsManager Overview".
6632	AVR J1939 Device type	2	[Off]	AVR J1939 voltage setpoint is off.
			Standard	Voltage setpoint for AVR is transmitted via CAN J1939 SPN 3386 to the AVR.
5494	Volt. SP (J1939) max.	2	100.0 to 150.0% [105.0%]	This parameter defines the scaling between the result of "AM V. SP PID-source [%]" and the transmitted CAN voltage setpoint. It defines the maximum deviation of the setpoint from " 5602 Generator rated voltage". Where "Generator rated voltage" is transmitted if the result of AM V. SP PID-source [%]" is 50 %. E.g. if 105.0 % is configured here and the result of "AM V. SP PID-source [%]" is 0 - 100, the transmitted voltage setpoint is scaled to 95 to 105 % of "Generator rated voltage". The value of the transmitted voltage setpoint is indicated by the analog variables "14.54 Volt. SP SPN 3386 [V]" and "14.04 Volt. SP SPN 3386 [%]".
5602	AM V. SP PID-source [%]	2	Determined by AnalogManager 81.35 [A1 = 11.02 Voltage bias [%]]	The voltage setpoint source for AVR via CAN J1939 may be selected from the available data sources. Usually the output of the voltage PID (0-100 %) "11.02 Voltage bias [%]" or "14.01 Excitation AVR [%]" is assigned here.

4.4.4.1.1 AVR

Introduction

In combination with the external excitation module "easYgen | exciter 10" (EX-10) or AVRbridge-10-P1 the easYgen-3000XT can replace the traditional external AVR. In this mode the easYgen-3000XT provides the voltage controller algorithm based on the own AC measurement and sends an excitation control signal to the excitation module. The excitation module itself acts as a power amplifier for the PWM signal and provides the excitation current to the generator. For more details of hardware and wiring refer to "easYgen | exciter 10" manual.

The AVRbridge-10-P1 basically acts as a power amplifier too, but instead of PWM an excitation current is transmitted via J1939 CAN connection to the excitation module and the easYgen is receiving some diagnostic data from the module.

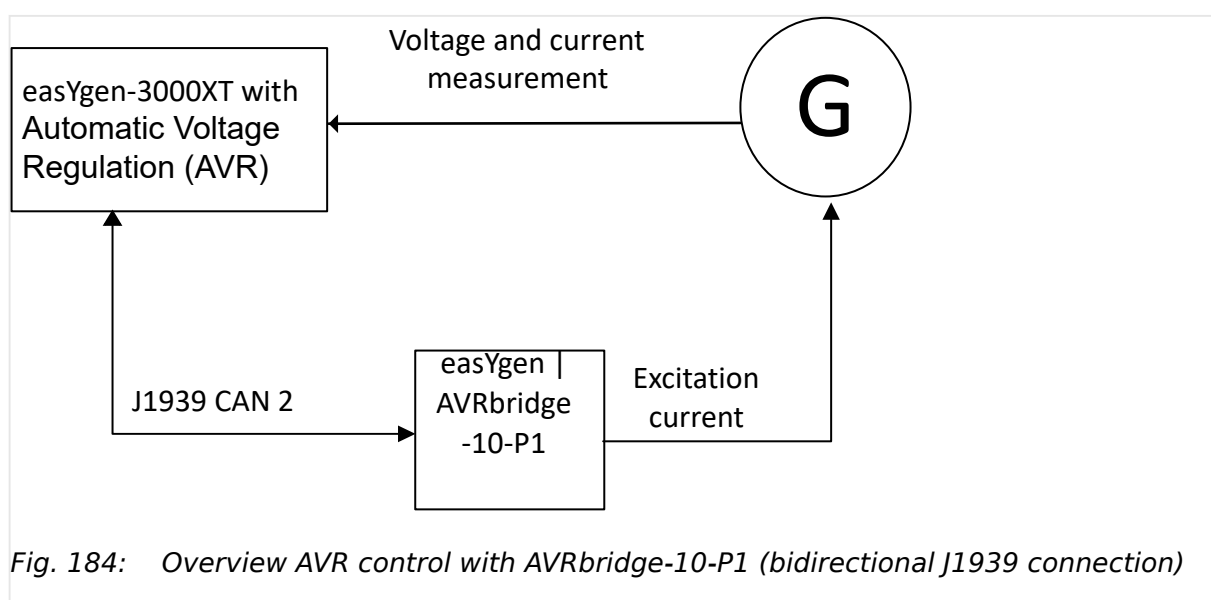
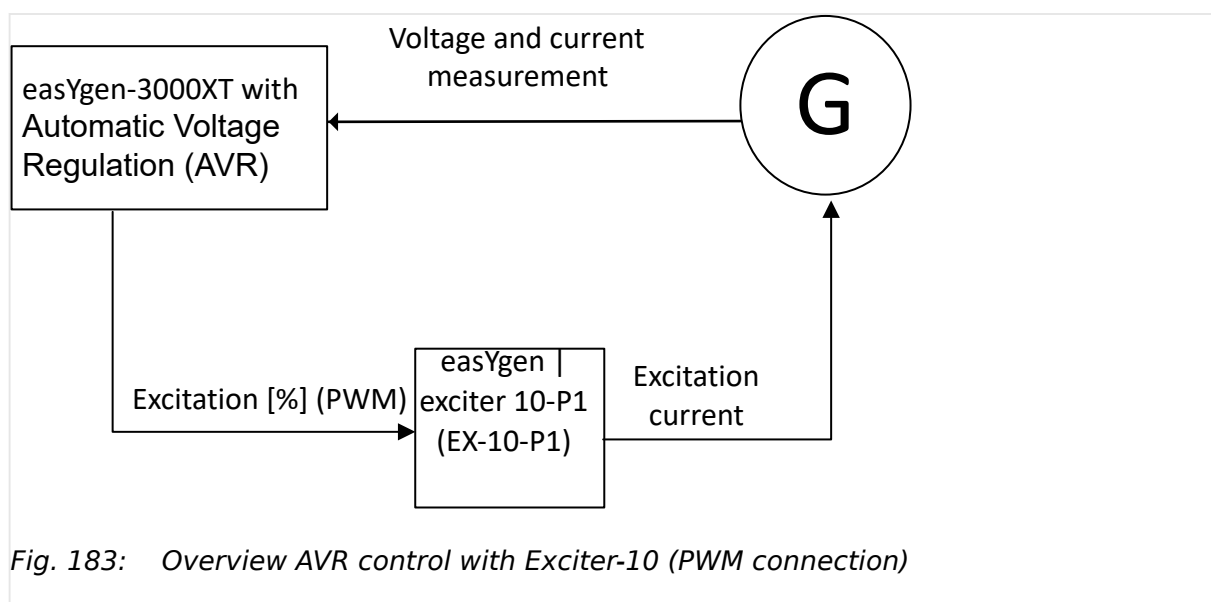

This function needs the "easYgen | exciter 10" or "easYgen | AVRbridge-10-P1" module to transform the excitation control signal into an exciter current.

The easYgen-3000XT with integrated voltage regulator provides:

- Automatic voltage regulation
- Soft start functionality
- Under frequency regulation V(f) defined by reference points and activated by LogicsManager
- Power factor and kvar control
- Reactive droop compensation
- Line drop compensation via AnalogManager

The excitation control signal for **Exiter-10** is usually assigned to analog output 2 (terminal 19/20). The corresponding AnalogManager must be configured to hardware type PWM with output level 5 V, A1 assigned to "14.01 Excitation AVR [%]".

The excitation control signal for **AVRbridge-10-P1** is transmitted via J1939 CAN.



With activating the AVR function, the kvar control (PF control) is automatically included. Therefore the parameter "5625 Power factor control" is faded out.

AVR Soft start sequence

The soft start is providing some adjustments to control the voltage properly during ramp up the generator after cranking.

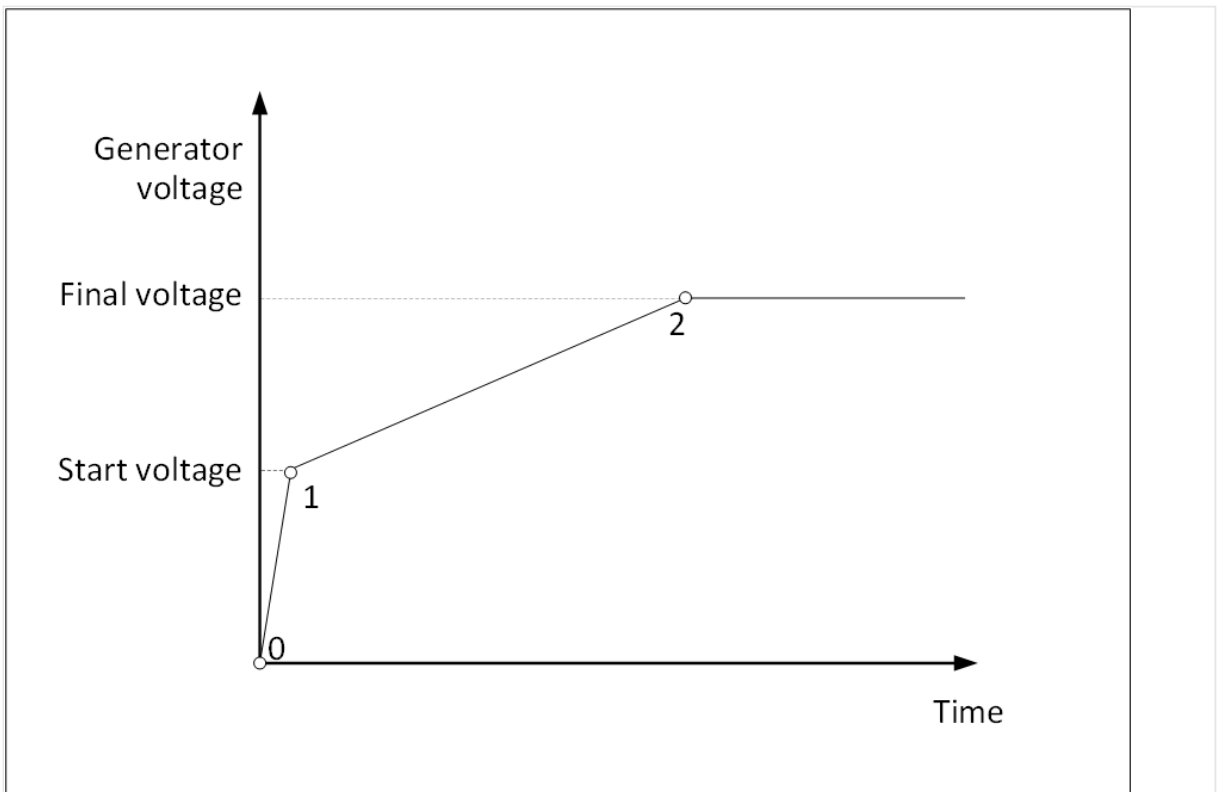

Fig. 185: The AVR Start sequence

Controlling voltage and kvar

The AVR voltage controller is taking care about the voltage control in isolated operation and the power factor- or kvar control in parallel to mains operation. The LogicsManager "12941 Q control" switches between voltage and power factor control. The PID settings for voltage and kvar are used as well for the AVR as for the PID analog function.

So all parameters remains valid except the parameters "Start value" and "Start delay".

Observing values via ToolKit

To observe the excitation control signal and the internal voltage setpoint the device indicates on ToolKit fields:

- 14.01 Excitation AVR [%]

- 14.02 Volt. setp. V(f) [%]
- 14.52 Volt. setp. V(f) [V]

For AVRbridge-10-P1 applications:

- 14.53 Excitation SP [A] (Setpoint passed via J1939 to AVRbridge-10-P1)
- 09.31 3381:Excitation curr. [A] (SPN 3381 Measured generator excitation field current received from AVRbridge-10-P1)

Enabling the AVR

To enable the AVR PID and its output at all the easYgen must enable the excitation. This can be recognized with the LM command variable "03.24 Excitation enabled". Further it is required that the generator frequency (or according engine speed) has passed a frequency limit. It is configurable with the parameter 5476 "Min.frequency for excitation". If the minimal frequency argue is not needed it can be set on 0.00Hz.

Starting ramp to initial setpoint

The AVR start sequence defines the point 1 as enabling the AVR PID with full biasing access. This point is usually reached if the real generator voltage is reaching the start voltage level. As an additional argue to reach the point 1 can be taken a voltage change level per time unit. This can help to recognize faster a dramatic spin up of the generator voltage and counteract accordingly earlier with enabling the PID. If the maximal voltage rate of change is not needed it can be set 0 %/s.

Start mode "Variable"

Accoding to the AVR Start sequence figure the start procedure is as follow::

Point 0: The engine is starting and "03.24 Excitation enabled" is active:

- The AVR PID is enabled and is fed with the setpoint ID5632 "Start voltage"
- The PID output is limited at this time by parameter 5634 "Max. starting excitation"

Point 1: The "Start voltage" is reached or the max. voltage rate of change is passed:

- The excitation limit (5634) is lifted, the AVR PID gets as first setpoint the real generator voltage
- The ramp defined by parameter "Starting ramp" becomes active, the setpoint is ramping up to the final voltage setpoint,
- The LogicsManager "AVR Enable V(f)" can be used to enable the V(f)-characteristic. Refer to AVR V(f) setting.

Point 2: The initial voltage setpoint is reached:

- The Parameter "Starting ramp" has no influence anymore. From now on, the common parameter "Voltage control setpoint ramp" is valid.

Start mode "Constant"

Accoding to the AVR Start sequence figure the start procedure is as follow::

Point 0: The engine is starting and "03.24 Excitation enabled" is active:

- The AVR PID remains disabled and its output is fixed with an constant excitation configurable with parameter 5478 "Starting excitation level". This phase will be over if the 5632 "Start voltage" is reached.

Point 1: The "Start voltage" is reached or the max. voltage rate of change is passed:

- The PID is released. The PID starts now with the real generator voltage as first setpoint. This setpoint will be ramped up to the final generator setpoint. The ramp rate is configurable under parameter 5633 "Starting ramp".
- In the moment the PID is released the first PID output can be individually set with the parameter 5479 "Init. PID excitation level. Through this special adjustment 3 cases are considerable:
 - Case 1 - The initial PID excitation level is the same like the starting excitation level. The PID output starts on the same level as before.
 - Case 2 - The initial PID excitation is lower than the starting excitation level. Thus, a certain deceleration of the rising generator voltage can be achieved in order to avoid a first violent overshoot.
 - Case 3 - The initial PID excitation is higher than the starting excitation level. Thus, a certain acceleration of the increasing generator voltage can be achieved.
- The LogicsManager "AVR Enable V(f)" can be used to enable the V(f)-characteristic. Refer to AVR V(f) setting.

Point 2: The initial voltage setpoint is reached:

- The Parameter "Starting ramp" has no influence anymore. From now on, the common parameter "Voltage control setpoint ramp" is valid.

AnalogManager variables:

The AVR function is providing the following analog variables which can be assigned to AnalogManager:

- 14.01 Excitation AVR [%] (actual excitation usually assigned to the AnalogManager of analog output 2)
- 14.02 Volt. setp. V(f) [%] (setpoint: if "AVR Enable V(f)" is active, adjusted by the "V(f) characteristic")
- 14.52 Volt. setp. V(f) [V]

For AVRbridge-10-P1 applications:

- 14.03 Excitation SP [%] (Setpoint passed via J1939 to AVRbridge-10-P1, % of "5497 Rated excitation field current")
- 14.53 Excitation SP [A] (Setpoint passed via J1939 to AVRbridge-10-P1)
- 09.31 3381:Excitation curr.[A] (SPN 3381 Measured generator excitation field current received from AVRbridge-10-P1)

LogicsManager variables ("AVRbridge-10-P1" only):

The AVR function is providing the following logic variables which can be assigned to LogicsManager:

- 06.37 Open diode fault
- 06.38 Shorted diode fault
- 06.39 Power supply fault
- 06.40 IGBT fault
- 06.41 Power bridge fault

ID	Parameter	CL	Setting range [Default]	Description (refer to "↳ "AVR Soft start sequence" for further explanation)
5496	Device	2	[Exciter-10]	Exciter-10 is selected (PWM connection)
			AVRbridge-10-P1	AVRbridge-10-P1 is selected (J1939 CAN connection) Note: There is a AVR J1939 monitoring possible, refer to ↳ "4.5.6.7 CAN Interface 2 - J1939 Interface".
5624	Voltage filter time	2	0 to 1 s [0 s]	The measured generator voltage can be filtered. The filter output value have 63% from the input value after the configured filter time. The filtered value is passed to the PID controller.
5476	Min.frequency for excitation	2	0 to 85 Hz [0.00 Hz]	If the generator frequency or the according speed of the engine is higher than the min. frequency for excitation the AVR soft start sequence is started.
5632	Start voltage	2	10 to 90% [50%]	This is the start set-point for the voltage controller. (Related to "Generator rated voltage")
5475	Max.voltage rate of change	2	0 to 500%/s [0%/s]	If during the soft start sequence the generator voltage increases more than the rate of change level the AVR PID is enabled with full excitation output range.
5633	Starting ramp	2	1 to 300% [5%]	The voltage controller uses the setpoint ramp during starting from the start

ID	Parameter	CL	Setting range [Default]	Description (refer to "↳ "AVR Soft start sequence"" for further explanation)
				voltage values to the active voltage reference
5477	Excitation start mode	2	[Variable] Constant	This parameter defines in which mode the soft start sequence shall run. Variable: The AVR PID output is to all time variable even it is limited. Constant: The AVR PID output is fixed during the soft start sequence 0 and is if the generator start voltage is reached set on a beginning level.
5478	Starting excitation level	2	1 to 98% [20%]	If the excitation start mode is configured on "Constant" a fixed starting excitation level can be configured here until the "Start Voltage" is reached. This parameter is ignored if the start mode is configured on "Variable".
5479	Init. PID excitation level	2	1 to 98% [20%]	If the excitation start mode is configured on "Constant" an initial PID excitation output can be set in the first moment the Start voltage is reached. This parameter is ignored if the start mode is configured on "Variable".
5634	Max. starting excitation	2	1 to 90% [20%]	During start procedure "14.01 Excitation AVR [%]" is limited to this value. If the measured voltage reaches the "Start voltage", this excitation limit is removed.
5497	Rated excitation field current	2	0.1 to 5 A [5 A]	This is the rated generator field current. (This value is transmitted to the Exciter-10- P2 via CAN J1939)
5495	Maximum excitation current	2	100 to 200% [140%]	This is the maximal generator field current related to "Rated excitation field current". (This value is

ID	Parameter	CL	Setting range [Default]	Description (refer to "↳ "AVR Soft start sequence"" for further explanation)
				transmitted to the Exciter- 15 via CAN J1939)
5493	Source excitation SP	2	Determined by AnalogManager 81.36 [A1 = 14.01 Excitation AVR [%]]	This is the desired generator field current related to "Rated excitation field current" and "Maximum excitation current". (This value is transmitted to the Exciter- 15 via CAN J1939)

Parameter Under frequency regulation V(f) characteristic

The AVR function provides a frequency related voltage set-point adaptation. To enable the V(f)-characteristic the LogicsManager "AVR Enable V(f)" is set on TRUE. The voltage set-point V(f) is defined with five reference points. The reference points are interpolated to each other. The result of this characteristic related to the current setpoint (not to the rated voltage) is passed as final setpoint to the PID control. Additionally it is available as analog variable 14.02 Volt. setp. V(f) [%] and 14.52 Volt. setp. V(f) [V]1.

ID	Parameter	CL	Setting range [Default]	Description
5480	Point 1 frequency	2	15 to 85 Hz	Frequency reference point
5482			5480: [15 Hz]	
5484			5482: [30 Hz]	
5486			5484: [40 Hz]	
5488			5486: [50 Hz] 5488: [60 Hz]	
5481	Point 1 voltage	2	50 to 110%	Voltage reference point
5483			5481: [50%]	
5485			5483: [50%]	
5487			5485: [80%]	
5489			5487: [100%] 5489: [100%]	
12037	AVR Enable V(f)	2	Determined by LogicsManager 86.46 [(02.01 LM FALSE & 1) & 86.97 LM: Release V-control] = 10848	If this LogicsManager condition is TRUE, the frequency regulation V(f) characteristic defined above becomes active.

Line drop (/line loss) compensation

In some applications e.g. where there is a large distance between generator and load, the resistance of the wire will cause a significant voltage drop. This could be compensated by adjusting the voltage set-point in dependence of the apparent power. The compensation could be realized by adding a percent value (e.g. 10%) of "01.32 Gen.app.power [%]" to the voltage setpoint "05.57 Internal v setp1 [V]" at the AnalogManager "AM Voltage SP1 [V]" for the voltage set-point.

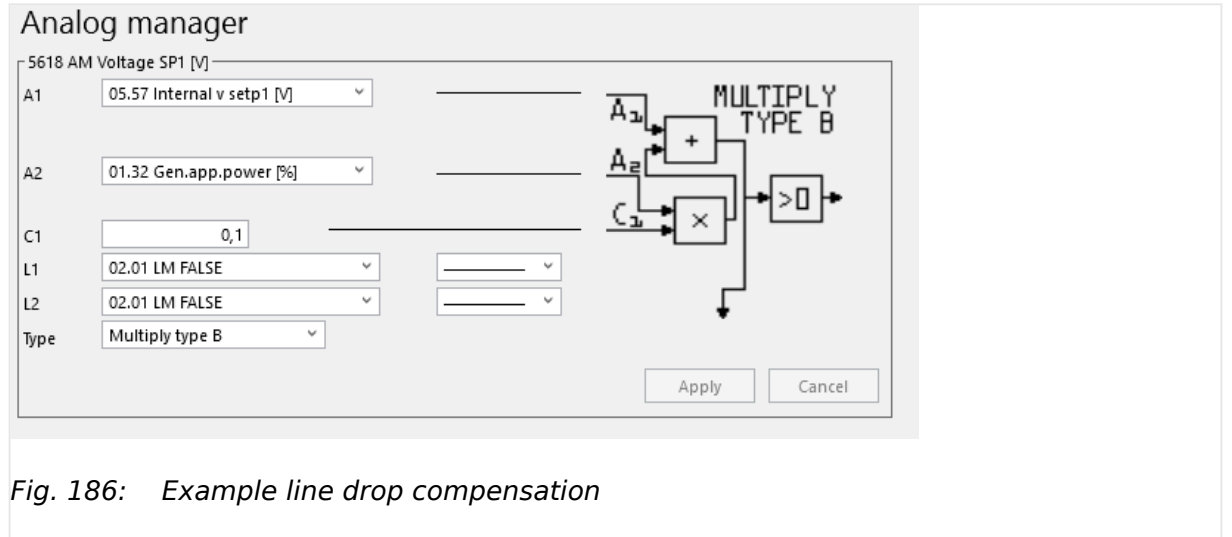

Fig. 186: Example line drop compensation

4.4.4.2 Power Factor Control

The easYgen cover a wide range of power factor control tasks:

- Controller type can be selected for an analog PID or a three-step controller (see chapter [4.4.4.2.2 Configure Power Factor / kvar Control](#))
- PF(P) characteristic is available (see chapter [4.4.4.2 Power Factor Control](#))
- Beside PF(P) characteristic, Q(V) characteristic is available too (see chapter [4.4.4.2 Power Factor Control](#)).
- Reactive power control at the interchange point offers another opportunity of power factor control (see chapter [4.4.4.2.1 Control The Power Factor / Reactive Power At The Mains Interchange Point](#)).

4.4.4.2.1 Control The Power Factor / Reactive Power At The Mains Interchange Point

General notes

Being parallel to the utility, it is desired in some application to control either the power factor or the amount of imported/exported inductive reactive power in kvar at the mains interchange point. Similar to an import/export active power setpoint, all easYgens can be programmed to the same setpoint and will share between each other the reactive power to reach this setpoint.

The easYgen can work as reactive power control at the interchange point. In this mode the gensets are monitored and restricted in reactive power flow (outcome and income; respectively leading and lagging).

Generator Reactive Power Limitations

A reactive power control (kvar or power factor) can cause an overload or damage of the generator. To avoid this the easYgen provides a 2-step protection:



1. ▷ The own absolute generator current is monitored with a percentage setting related to rated current input (ID [1754](#)). The easYgen limits or controls down the excitation that this given level (ID [5791](#)) is not exceeded.
2. ▷ The inductive reactive power **outcome** of the own generator is limited according to the configuration of ID [5792](#).
Or:
The inductive reactive power **income** of the own generator is limited according to the configuration of ID [5793](#).

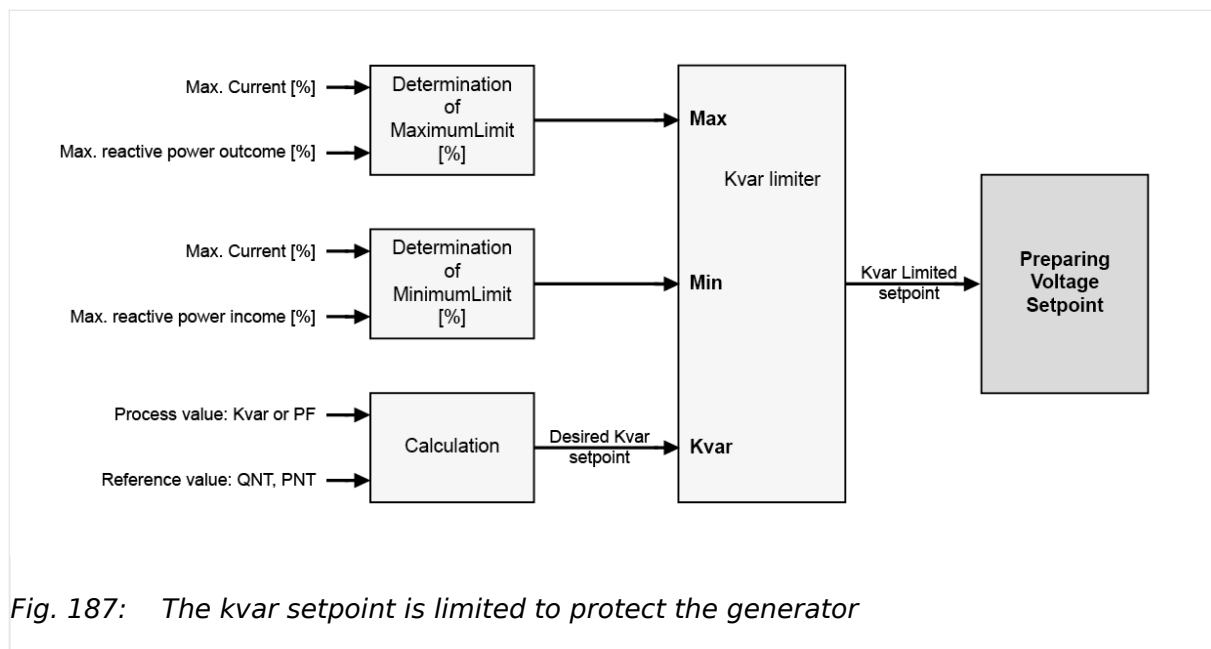

Tracking of the limitation

An active Limitation is

- indicated as 'Gen excitation lim.' on the display (HMI)
- driving the LogicsManager command variable 02.38 Gen excitation lim. from FALSE to TRUE
- driving an event logger entry



If kvar (Q) control is not used in the easYgen but the LogicsManager "12941 Q-Control" is TRUE in mains parallel operation, under some circumstances the message "Gen excitation lim." could be shown. This has no impact on the kvar regulation but it can be prevented if

- "12941 Q-Control" is set always to FALSE or
- the kvar setpoint is adapted accordingly.

4.4.4.2.2 Configure Power Factor / kvar Control

ID	Parameter	CL	Setting range [Default]	Description
5625	Power factor control	2	[PID analog]	The power factor is controlled using an analog PID controller.
			3pos controller	The power factor is controlled using a three-step controller.
			Off	Power factor control is not carried out.
5613	Proportional gain	2	0.01 to 100.00 [1.00]	<p>The proportional coefficient specifies the gain. By increasing the gain, the response is increased to permit larger corrections to the variable to be controlled.</p> <p>The farther out of tolerance the process is the larger the response action is to return the process to the tolerance band.</p>
				<p>Notes</p> <p>If the gain is configured too high, the result is excessive overshoot/undershoot of the desired value.</p> <p>This parameter is only visible if power factor control (parameter ↩ 5625) is configured to "PID analog".</p>
5614	Integral gain	2	0.001 to 100.000 [1.000]	<p>The integral gain identifies the I part of the PID controller. The integral gain corrects for any offset (between setpoint and process variable) automatically over time by shifting the proportioning band.</p> <p>Reset automatically changes the output requirements until the process variable and the setpoint are the same. This parameter permits the user to adjust how quickly the reset attempts to correct for any offset. The integral gain constant must be greater than the derivative time constant.</p> <p>If the integral gain constant is too large, the engine will continually oscillate. If the integral gain constant is too small, the engine</p>

ID	Parameter	CL	Setting range [Default]	Description
				will take too long to settle at a steady state.
				<p>Notes</p> <p>This parameter is only visible if power factor control (parameter ↔ 5625) is configured to "PID analog".</p>
5615	Derivative ratio	2	0.01 to 100.00 [0.01]	<p>The derivative ratio identifies the D part of the PID controller. By increasing this parameter, the stability of the system is increased.</p> <p>The controller will attempt to slow down the action of the actuator in an attempt to prevent excessive overshoot or undershoot.</p> <p>Essentially this is the brake for the process. This portion of the PID loop operates anywhere within the range of the process unlike reset.</p>
				<p>Notes</p> <p>This parameter is only visible if power factor control (parameter ↔ 5625) is configured to "PID analog".</p> <p>The default configured controller acts like a PI controller what is the valid D part setting for systems with secondary controllers.</p>
5660	Deadband	1	0.001 to 0.300 [0.010]	<p>The generator power factor is controlled in such a manner, when paralleled with the mains, so that the monitored power factor does not deviate from the configured power factor setpoint by more than the value configured in this parameter without the controller issuing a raise/lower signal to the voltage regulator.</p> <p>This prevents unneeded wear on the raise/lower relay contacts.</p>
				<p>Notes</p> <p>This parameter is only visible if power factor control (parameter ↔ 5625) is configured to "3pos controller".</p>
5661	Time pulse minimum	1	0.01 to 2.00 s [0.05 s]	<p>A minimum pulse on time must be configured here.</p> <p>The shortest possible pulse time should be configured to limit overshoot of the desired power factor reference point.</p>
				<p>Notes</p>

4 Configuration

4.4.4.2.2 Configure Power Factor / kvar Control

ID	Parameter	CL	Setting range [Default]	Description
				This parameter is only visible if power factor control (parameter ↩ 5625) is configured to "3pos controller".
5662	Gain factor	1	0.1 to 10.0 [5.0]	<p>The gain factor K_p influences the operating time of the relays.</p> <p>By increasing the number configured in this parameter, the operating time of the relay will be in-creased in response to a deviation from the power factor reference.</p> <p>By increasing the gain, the response is increased to permit larger corrections to the variable to be controlled.</p> <p>The farther out of tolerance the process is the larger the response action is to return the process to the tolerance band. If the gain is configured too high, the result is excessive overshoot/undershoot of the desired value.</p>
				<p>Notes</p> <p>This parameter is only visible if power factor control (parameter ↩ 5625) is configured to "3pos controller".</p>
5667	Cycle time factor	1	1.0 to 20.0 [1.0]	<p>The cycle time factor adjusts the time between the pulses (pause time).</p> <p>By increasing the cycle time factor, the time between the pulses increases.</p>
				<p>Notes</p> <p>This parameter is only visible if voltage control (parameter ↩ 5625) is configured to "3pos controller".</p>
5663	Expand deadband factor	1	1.0 to 9.9 [1.0]	<p>If the measured generator power factor is within the deadband range (parameter ↩ 5660) and the configured delay expand deadband time (parameter ↩ 5664) expires, the deadband will be multiplied with the factor configured here.</p>
				<p>Notes</p> <p>This parameter is only visible if power factor control (parameter ↩ 5625) is configured to "3pos controller".</p>
5664	Delay expand deadband	1	1.0 to 9.9 s	The measured generator power factor must be within the deadband range for the time

ID	Parameter	CL	Setting range [Default]	Description
			[2.0 s]	configured here in order to multiply the deadband with the factor configured in parameter ↩ 5663 .
				Notes This parameter is only visible if power factor control (parameter ↩ 5625) is configured to "3pos controller".
5791	Max. generator current	2	0 to 150% [100%]	This is the maximum generator current during reactive power control. The percentage is related to the rated current setting (ID ↩ 1754).
5792	Max.react.inductive pwr.gen.	2	0 to 150% [80%]	This is the maximum accepted generator reactive inductive load (outcome) during reactive power control at the interchange point. The percentage is related to the reactive power setting (ID ↩ 1758).
5793	Max.react.capactive pwr.gen.	2	0 to 150% [50%]	This is the maximum accepted generator reactive capacitive load (income) during reactive power control at the interchange point. The percentage is related to the reactive power setting (ID ↩ 1758).
5638	AM PF/kvar SP1[-/ kvar]	2	Determined by AnalogManager 81.11 [A1 = 05.10 Intern. PF setp1 [%]]	The power factor / reactive power setpoint 1 source can be selected from the available data sources. The internal "05.10 Intern. PF setp1 [%]" can be changed manually at the setpoint screen of the display.
5639	AM PF/kvar SP2[-/ kvar]	2	Determined by AnalogManager 81.05 [A1 = 05.11 Intern. PF setp2 [%]]	The power factor / reactive power setpoint 2 source can be selected from the available data sources. The internal "05.11 Intern. PF setp2 [%]" can be changed manually at the setpoint screen of the display.
5743	PF/kvar setpoint 1 mode		[Gen.PF] Mns.Export kvar Mns.Import kvar Mains PF Gen.kvar	Determination of the reactive power control argument (Modes) Gen.PF: The value entered as PF/kvar setpoint is a generator power factor setpoint. Mns.Export kvar: The value entered as PF/kvar setpoint is a mains export power setpoint in kvar. Note: Even the value is also configurable as negative value do not enter a negative value in this mode. Mns.Import kvar: The value entered as PF/kvar setpoint is a mains import power setpoint in

4 Configuration

4.4.4.2.2 Configure Power Factor / kvar Control

ID	Parameter	CL	Setting range [Default]	Description
				<p>kvar. Note: Even the value is also configurable as negative value do not enter a negative value in this mode.</p> <p>Mains PF: The value entered as PF/kvar setpoint is a mains power factor setpoint at the interchange point to mains.</p> <p>Gen.kvar: The value entered as PF/kvar setpoint is a generator kvar power setpoint (-99999.9 to 99999.0 kvar). Note: A negative value is accepted as a capacitive kvar setpoint. A positive value is accepted as inductive setpoint in this mode.</p>
5620	Int. power factor setpoint 1	2	-0.999 to +1.000 [+1.000]	<p>The desired power factor may be configured here so that the reactive power is regulated in the system.</p> <p>The designations "+" and "-" stand for inductive/lagging (generator overexcited) and capacitive/leading (generator underexcited) reactive power.</p> <p>This setpoint is active only in mains parallel operation.</p>
5744	PF/kvar setpoint 2 mode		<p>[Gen.PF]</p> <p>Mns.Export kvar</p> <p>Mns.Import kvar</p> <p>Mains PF</p> <p>Gen.kvar</p>	<p>Determination of the reactive power control argument (Modes)</p> <p>Gen.PF: The value entered as PF/ kvar setpoint is a generator power factor setpoint.</p> <p>Mns.Export kvar: The value entered as PF/kvar setpoint is a mains export power setpoint in kvar. Note: Even the value is also configurable as negative value do not enter a negative value in this mode.</p> <p>Mns.Import kvar: The value entered as PF/kvar setpoint is a mains import power setpoint in kvar. Note: Even the value is also configurable as negative value do not enter a negative value in this mode.</p> <p>Mains PF: The value entered as PF/kvar setpoint is a mains power factor setpoint at the interchange point to mains.</p> <p>Gen.kvar: The value entered as PF/kvar setpoint is a generator kvar power setpoint (-99999.9 to 99999.0 kvar). Note: A negative value is accepted as a capacitive kvar setpoint. A positive value is accepted as inductive setpoint in this mode.</p>

ID	Parameter	CL	Setting range [Default]	Description
5745	Int. kvar setpoint 1		-99999.9 to +99999.9 [0.0]	This setpoint is active only if PF/kvar setpoint 1 is set to Mns. Export kvar or Mns. Import kvar.
5621	Int. power factor setpoint 2	2	-0.999 to +1.000 [+1.000]	<p>The desired power factor may be configured here so that the reactive power is regulated in the system.</p> <p>The designations "-" and "+" stand for inductive/lagging (generator overexcited) and capacitive/leading (generator underexcited) reactive power. This setpoint is active only in mains parallel operation.</p>
5746	Int. kvar setpoint 2		-0.999 to +1.000 [0.000]	This setpoint is active only if PF/kvar setpoint 2 is set to Mns. Export kvar or Mns. Import kvar.
12921	Setp.2 pwr.factor	2	Determined by LogicsManager 86.84 [(0 & 1) & 1] = 11913	<p>If this LogicsManager condition is TRUE, the power factor setpoint 2 will be used instead of power factor setpoint 1. The power factor (result of AM) ↪ 5639 instead of ↪ 5638 will be taken into account.</p> <p>Notes</p> <p>For information on the LogicsManager and its default settings see ↪ "9.3.1 LogicsManager Overview".</p>
5622	React. pwr. ctrl setpoint ramp	2	0.01 to 100.00 %/s [3.00 %/s]	<p>The different setpoint values are supplied to the controller via this ramp.</p> <p>The slope of the ramp is used to alter the rate at which the controller modifies the setpoint value. The faster the change in the setpoint is to be carried out, the greater the value entered here must be.</p> <p>Notes</p> <p>This ramp is also used in islanded operation for loading or unloading an additional genset. An excessive oscillation may occur if the ramp is configured too high.</p>
1884	Gen. PF setpoint filter	2	0.0 to 99.9 s [0.0 s]	<p>The PT1-filter for the Gen PF or Gen kvar setpoint mode can be configured here. The parameter stands for the 3 times tau value of a PT1 element. (see drawing). That means the configured time defines when 95% of the original setpoint jump is reached.</p> <p>Notes</p>

ID	Parameter	CL	Setting range [Default]	Description
				Input 0.0 s disables the filter influence.
4559	Q filter time const.control	2	0.0 to 99.9 s [0.0 s]	The PT1-filter for the actual generator total reactive power value can be configured here. The parameter stands for the 3 times tau value of a PT1 element. That means the configured time defines when 95% of the original value jump is reached. The filtered value is used as input to the controller. Notes Input 0.0 s disables the filter influence.
12941	Q control	2	Determined by LogicsManager 86.99 [(04.07 MCB closed & 04.06 GCB closed) & 1] = 11928	With LogicsManager can be controlled if a voltage control or a reactive power control should be performed. If this LogicsManager condition is TRUE, the reactive power control is performed.

4.4.4.2.3 AVR FRT Adjustments

Introduction

If there is a LVRT (Low voltage ride through) or HVRT event which means the mains voltage jumps below a defined threshold (or over a defined threshold), the generator has to bear the mains for a defined time. Usually this is not possible with the current Var/PF setpoint. For this reason the easYgen is providing some parameters which become effective only in FRT situations.



The parameters for these FRT adjustments are only available if parameter "5607 Voltage control" is configured to AVR.

Adjusted Q setpoint

If any FRT is excited, a 5 points Q(V) characteristic (parameter 6660-6669) becomes active after the time defined by parameter "6658 Delay FRT SP" has exceeded. This characteristic defines the reactive power setpoint dependent from the measured generator voltage during FRT. -For LVRT this characteristic is using the lowest generator voltage, dependent on parameter "1770 Generator voltage monitoring". -For HVRT this characteristic is using the highest generator voltage, dependent on parameter "1770 Generator voltage monitoring". The resulting Var setpoint is visible in ToolKit "6657 VAR control FRT SP".

Underexcited case:

In case of under excitation (negative reactive power) in FRT case sometimes the controller is trending to swing. For this reason it is possible to activate the 2nd PID configuration (parameter 6654-6656) e.g. with smaller proportional gain. (The 5 point Q(V) characteristic is active in this case too.) The 2nd PID configuration becomes active if

-any FRT is excited and -the power factor is below the limit configured with "6659 2nd PID Q Limit FRT" and -the time "Delay FRT SP" has exceeded .

Command variables:

There are two command variables which can be assigned e.g. to a relay output during the commissioning:

07.35: FRT Q/V curve (True if any FRT is excited and "6658 Delay FRT SP" has exceeded.)

07.36: 2nd Q PID in FRT (True if 07.35 is true and "6659 2nd PID Q Limit FRT" is undercut.)

ID	Parameter	CL	Setting range [Default]	Description
6658	Delay FRT SP	2	0.00 to 1.00 [0.08]	If any FRT is excited, the special Q(V) characteristic becomes effective after this delay .
6659	2nd PID Q Limit FRT	2	-0.999 to -0.500 [-0.900]	If the measured power factor value in FRT case becomes higher (more capacitive) than this value and "Delay FRT SP" is exceeded, the 2nd PID configuration will become effective.
6654	2nd Proportional gain	2	0.01 to 100.00 [1.00]	Proportional gain if 2nd PID configuration is effective
6655	2nd Integral gain	2	0.001 to 100.000 [1.000]	Integral gain if 2nd PID configuration is effective
6656	2nd Derivative ratio	2	0.01 to 100.00 [1.00]	Derivative ratio if 2nd PID configuration is effective
6660 6662 6664 6666 6668	V FRT point 1	2	0% to 150% 6660: [0%] 6662: [30%] 6664: [60%] 6666: [90%] 6668: [120%]	Voltage for Q(V) characteristic in FRT case point @[1,2,3,4,5]
6661 6663 6665 6667 6669	Q FRT set point 1	2	-100% to 200% 6661: [100%] 6663: [70%] 6665: [40%] 6667: [10%] 6669: [-20%]	Q for Q(V) characteristic in FRT case set point @[1,2,3,4,5]

4.4.4.2.4 Power Factor Characteristic

General notes

 This feature is related to the former BDEW grid code. For the VDE-AR-N 4110 / 4105 grid code please refer the reactive power characteristics

The Power Factor Characteristic function is adapting the reactive power flow between generator and mains to support a dynamic stabilization of the mains. Some network provider prefer therefore a power factor control over real power PF(P) (see chapter [4.4.4.2.4.1 Power factor characteristic PF\(P\)](#) for more details).

Other provider prefer power factor control over mains voltage Q(V) as described in chapter [4.4.4.2.4.2 Power factor characteristic Q\(V\)](#). Both methods are configurable alternatively.

 **Enhanced according BDEW Requirements**

Both power factor characteristic curves now offer four point settings.

Factory settings come with backward compatibility.

4.4.4.2.4.1 Power factor characteristic PF(P)

A method to support the mains is to feed different reactive power values into the grid in relation to the own active power value. The reactive power is defined through a power factor setpoint for the generator. This can be defined in characteristic curve.

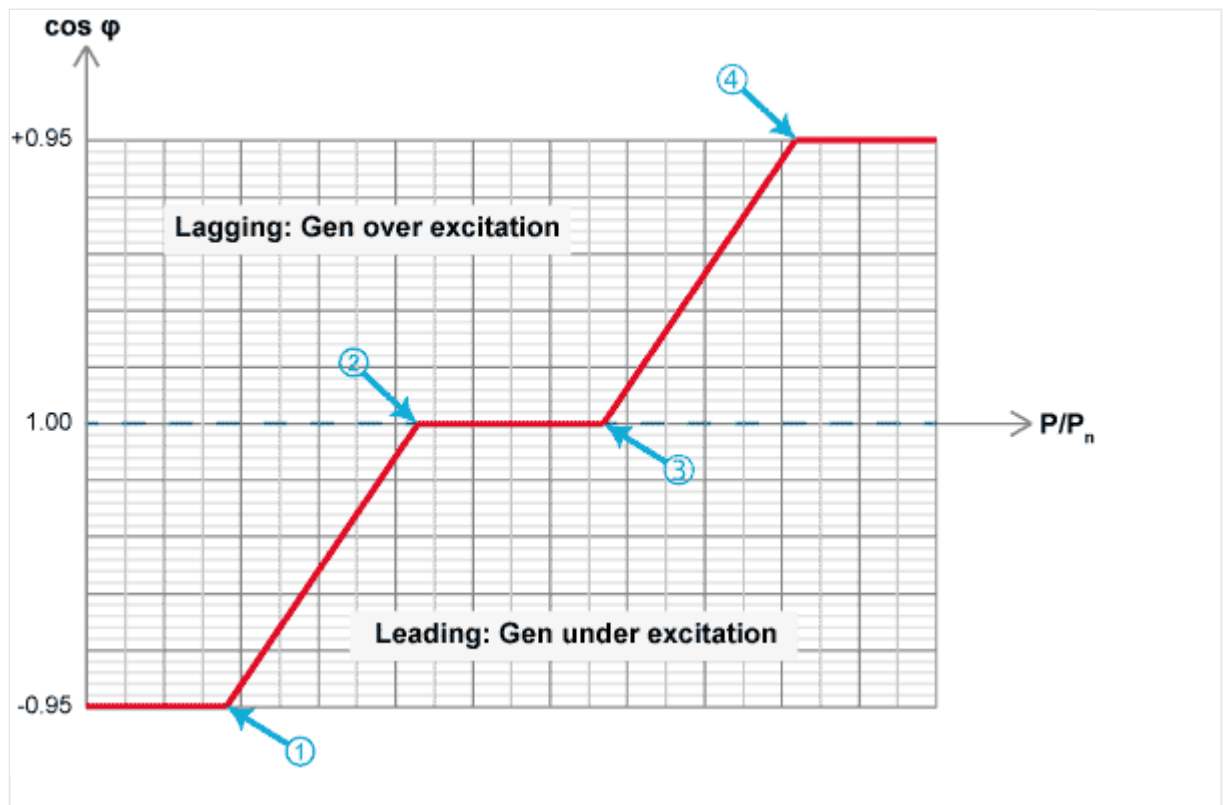

Fig. 188: Power factor characteristic (schematic)

The characteristic is defined by four points (① .. ④). The power factor corresponding to this characteristic is available as data source 05.29 in the AnalogManager.



To use this function, the source (05.29) must be applied as source to one of the setpoints e.g., "Power factor setpoint 1" (parameter [↪ 5638](#)).

ID	Parameter	CL	Setting range [Default]	Description
5786	Power factor characteristic	2	[PF(P)]	A power factor setpoint is determined according to the characteristic curve: Power factor in relation to the actual Generator power.
			Q(V)	A power factor setpoint is calculated according to the characteristic curve: Generator reactive power in relation to the mains voltage.
5787	Point 1 power	2	0.00 to 150.00% [0.00%]	The value entered into "Point 1 power" defines the cos phi (P) characteristic.
5788	Point 1 cos phi	2	-0.999 to 1.000 [-0.950]	The desired "Point 1 cos phi" may be configured here which defines the cos phi (P) characteristic. The designations "+" and "-" stand for inductive/lagging (generator overexcited) and capacitive/leading (generator underexcited) reactive power.
5789	Point 2 power	2	0.00 to 150.00% [100.00%]	The value entered into "Point 2 power" defines the cos phi (P) characteristic.
5790	Point 2 cos phi	2	-0.999 to 1.000 [0.950]	The desired "Point 2 cos phi" may be configured here which defines the cos phi (P) characteristic. The designations "+" and "-" stand for inductive/lagging (generator overexcited) and capacitive/leading (generator underexcited) reactive power.
5028	Point 3 power	2	0.00 to 150.00% [100.00%]	The value entered into "Point 3 power" defines the cos phi (P) characteristic.
5029	Point 3 cos phi	2	-0.999 to 1.000 [0.950]	The desired "Point 3 cos phi" may be configured here which defines the cos phi (P) characteristic. The designations "+" and "-" stand for inductive/lagging (generator overexcited) and capacitive/leading (generator underexcited) reactive power.
5030	Point 4 power	2	0.00 to 150.00% [100.00%]	The value entered into "Point 4 power" defines the cos phi (P) characteristic.

4 Configuration

4.4.4.2.4.2 Power factor characteristic Q(V)

ID	Parameter	CL	Setting range [Default]	Description
5031	Point 4 cos phi	2	-0.999 to 1.000 [0.950]	<p>The desired "Point 4 cos phi" may be configured here which defines the cos phi (P) characteristic.</p> <p>The designations "+" and "-" stand for inductive/lagging (generator overexcited) and capacitive/leading (generator underexcited) reactive power.</p>

4.4.4.2.4.2 Power factor characteristic Q(V)

Another method to support the mains is to feed different reactive power values into the grid in relation to the mains voltage [parameter \hookrightarrow 5786 = Q(V)]. The reactive power is defined through the value Q/S rated over voltage. This can be defined in a characteristic curve. The resulting outcome for the reactive power control is then a power factor setpoint.

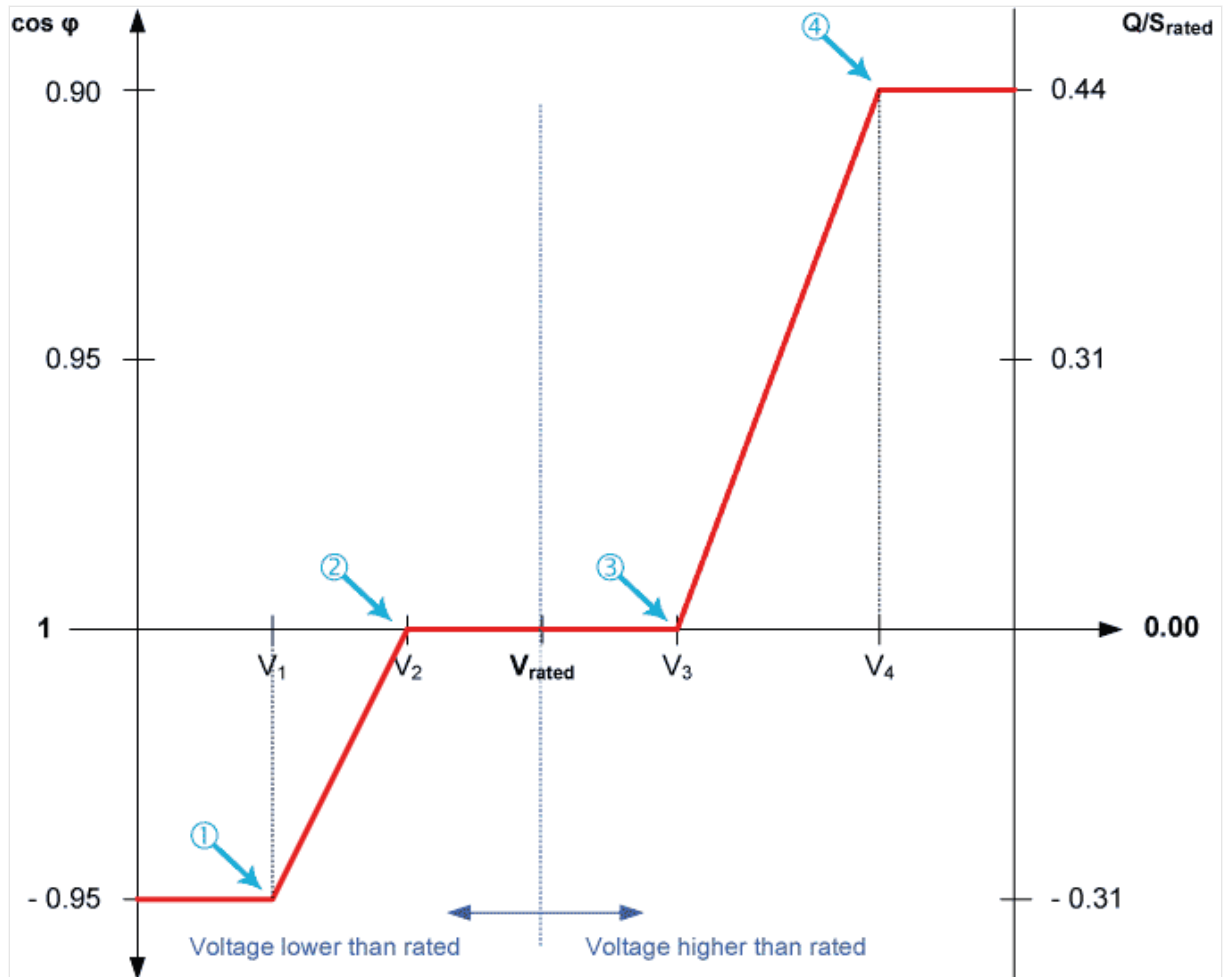

Fig. 189: Power factor characteristic according to the relation Q/S rated over rated voltage

The characteristic is defined by four points (① .. ④). The power factor corresponding to this characteristic is available as data source 05.29 in the AnalogManager.



To use this function, the source (05.29) must be applied as source to one of the setpoints e.g., "Power factor setpoint 1" (parameter [↩ 5638](#)).

ID	Parameter	CL	Setting range [Default]	Description
5778	Point 1 voltage		45.0 to 150.0% [98.0%]	The value entered into "Point 1 Voltage" defines the x-coordinate of point 1
5779	Point 1 Q/S rated		-0.99 to +0.99 [-0.31]	The value entered into "Point 1 Reactive power" defines the y-coordinate of point 1
5797	Point 2 voltage		45.0 to 150.0% [106.0%]	The value entered into "Point 2 Voltage" defines the x-coordinate of point 2
5798	Point 2 Q/S rated		-0.99 to +0.99 [+0.31]	The value entered into "Point 2 Reactive power" defines the y-coordinate of point 2
5032	Point 3 voltage		0.0 to 150.0% [106.0%]	The value entered into "Point 3 Voltage" defines the x-coordinate of point 3
5033	Point 3 Q/S rated		-0.99 to +0.99 [+0.31]	The value entered into "Point 3 Reactive power" defines the y-coordinate of point 3
5034	Point 4 voltage		0.0 to 150.0% [106.0%]	The value entered into "Point 4 Voltage" defines the x-coordinate of point 4
5035	Point 4 Q/S rated		-0.99 to +0.99 [+0.31]	The value entered into "Point 4 Reactive power" defines the y-coordinate of point 4
5799	Q(V) response time		001 to 999 s [10 s]	<p>The response with a new reactive power setpoint acting on the analog command variable "05.29 PF characteristic [%]" can be delayed. Q(V) response time is used to calculate the power factor characteristic Q(V), parameter ↩ 5786.</p> <p>Notes</p> <p>The delay is realized with a PT-1 filter. Therefore the reaction times are optimized for the range 10 s until 60 s within a symmetrical characteristic curve.</p> <p>Accuracy of the setup Q(V) response time is given within a symmetrical characteristic curve.</p>
5023	Q(V) Hysteresis		0 to 20% [0%]	The hysteresis for the Q(V) characteristic acts as a deadband for the selected band. If the Mains voltage is within the hysteresis the resulting power factor

4 Configuration

4.4.4.2.5 Reactive Power / Power Factor setpoint filter

ID	Parameter	CL	Setting range [Default]	Description
				characteristic reference doesn't change.

4.4.4.2.5 Reactive Power / Power Factor setpoint filter

Introduction

The FNN VDE-AR-N 4105 / 4110 requests a reactive power control with a setpoint which is leaded over a PT1-element. The PT1-element shall be adjustable with a 3 tau setting. The 3 tau setting defines at what time shall be reached 95% of the original setpoint change. This 3 tau value is configurable.

Function

The reactive power controller PID is always receiving a reactive power setpoint even the setpoint is entered as power factor or as power factor setpoint. The PT1 filter behavior is always included (Refer to drawing) but the filter can be configured so that it has no influence.

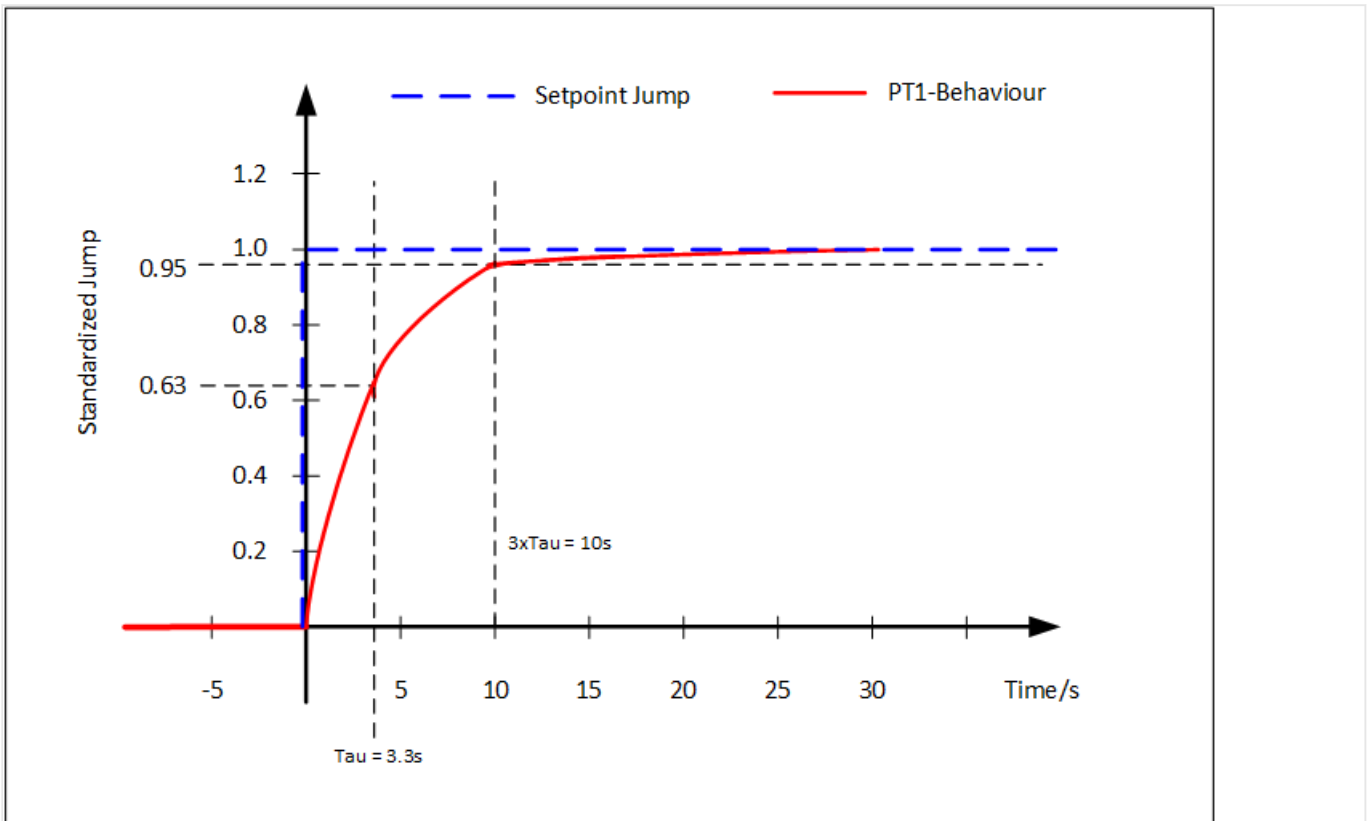

Fig. 190: Setpoint Jump (standardized with height 1) and the resulting PT1 setpoint

Four reactive power setpoint filters are placed in the easYgen in regards to:

- Gen PF setpoint setting
- Reactive power characteristic Q(V)

- Reactive power characteristic Q(P)
- Reactive power characteristic Q(V) limit

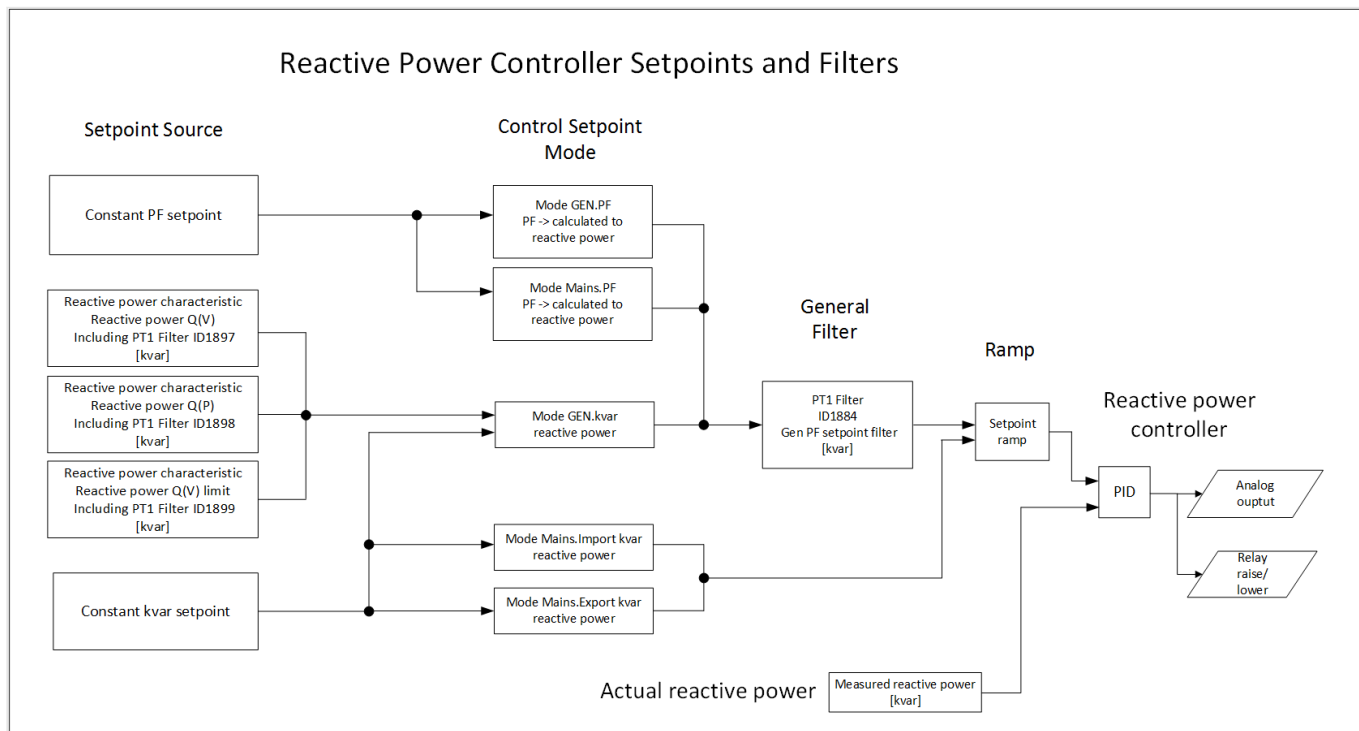

Fig. 191: The allocation of reactive power setpoints and their filters

Configuration

ID	Parameter	Setting range [Default]	Description
1884	Gen. PF setpoint filter	0 to 99.9 s [0.0 s]	The PT1-filter for the Gen PF setpoint mode can be configured here. The parameter stands for the 3 times tau value of a PT1 element. (see drawing). That means the configured time defines when 95% of the original setpoint jump is reached. Note: Input 0.0s disables the filter influence.
1897	Q(V) setpoint filter	0 to 99.9 s [10.0 s]	The PT1-filter for the reactive power characteristic Q(V) can be configured here. The parameter stands for the 3 times tau value of a PT1 element. (see drawing). That means the configured time defines when 95% of the original setpoint jump is reached. Note: Input 0.0s disables the filter influence.
1898	Q(P) setpoint filter	0 to 99.9 s [10.0 s]	The PT1-filter for the reactive power characteristic Q(P) can be configured here. The parameter stands for the 3 times tau value of

ID	Parameter	Setting range [Default]	Description
			a PT1 element. (see drawing). That means the configured time defines when 95% of the original setpoint jump is reached. Note: Input 0.0s disables the filter influence.
1899	Q(V) limit setpoint filter	0 to 99.9 s [10.0 s]	The PT1-filter for the reactive power characteristic Q(V) limit can be configured here. The parameter stands for the 3 times tau value of a PT1 element. (see drawing). That means the configured time defines when 95% of the original setpoint jump is reached. Note: Input 0.0s disables the filter influence.

4.4.4.2.6 Reactive Power Characteristic

4.4.4.2.6.1 Reactive power Q(V)

General notes



This feature is related to the VDE-AR-N 4110 / 4105 grid code. For BDEW related grid code please refer to [“4.4.4.2 Power Factor Control”](#).

The FNN VDE-AR-N 4105 / 4110 requests different methods for reactive power control during mains faults to stabilize the mains.

This method determines a reactive power setpoint deviation based on the mains voltage deviation from a rated mains voltage value.

The slope follows the formula:

$$\text{Slope}(QV) = \frac{(Q_{\max} / P_{\text{inst.}})}{(V_{\max} / V_c) - (V_{Q0} / V_c)}$$

The formula contains a factor which can shift the curve on the voltage axis. The shift itself can be determined through an analog value “VQ0”. This gives the network provider the capability to change the reactive power influence remotely.

Function

This procedure of running different reactive power values over the voltage is based on two points:

Point 1 is defined as the reference voltage on which the reactive power shall be zero.

Point 2 is defined through the value pair (Vmax/VC ; Qmax/Pinst.). This point defines finally the maximal reactive power, which is allowed to run for the generator. It is valid for leading and lagging reactive power (Under-excitation/Over-excitation).

So if mains voltage exceeds the V_{max}/V_C point inductive power is absorbed and with surpassed V_{max}/V_C inductive reactive power is delivered to mains.

Furthermore the function provides the capability to shift point 1 on the x-axis from outside. Through this it can be determined afterwards at what mains voltage level the reactive power flow begins to work.

Through a dead band incorporation into the function the operator can determine to stay on a last calculated reactive power. So as long the mains voltage deviates not again around a dead band width the last setpoint is kept.

And finally through a test function the function gives the operator the opportunity to simulate different mains voltages to observe whether the reactive power flow is maintained properly.

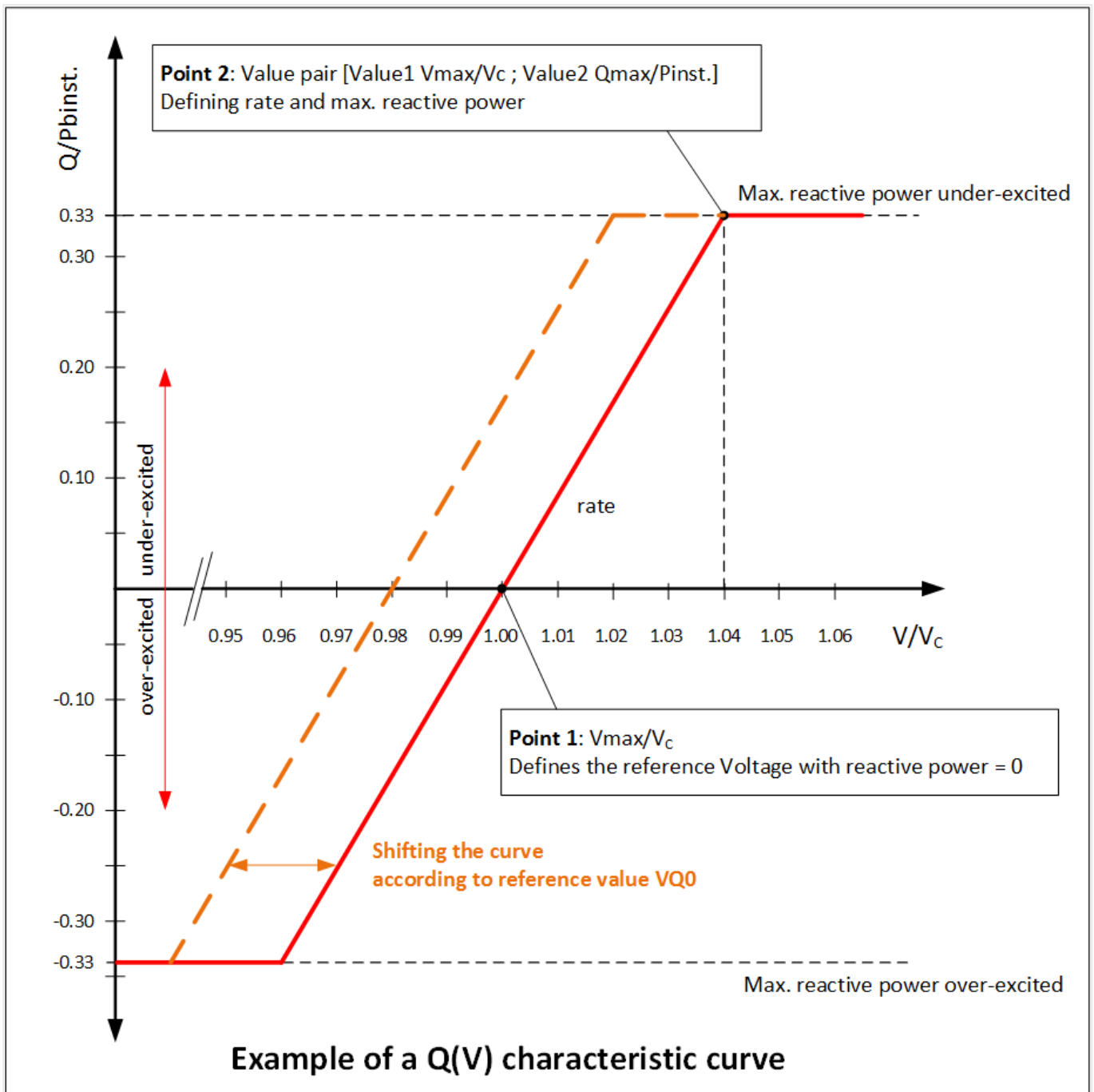

Fig. 192: EGXT_Example_of_a_Q(V)_characteristic

4 Configuration

4.4.4.2.6.1 Reactive power Q(V)

ID	Parameter	Setting range [Default]	Description
5823	Vmax/Vc	1.00 to 1.20 [1.04]	<p>The point 2 defines the maximal allowed reactive power for the generator. The point determines the leading limit as also the lagging limit. Refer to drawing.</p> <p>This value determines the value 1 (Vmax/VC) of the point 2 value pair. This is the maximum voltage which can be transacted.</p> <p>Maximum voltage in relation to the supply voltage (Vc). Mostly the supply voltage is similar to the rated voltage in the system.</p>
5824	Qmax/Pinst.	0.00 to 0.50 [0.33]	<p>The point 2 defines the maximal allowed reactive power for the generator. The point determines the leading limit as also the lagging limit. Refer to drawing. This value determines the value 2 (Qmax/Pinst.) of the point 2 value pair.</p> <p>Maximum reactive power in relation to the installed active power from the power generation device. The installed active power is usually the rated generator power. The maximum reactive power defines the positive and negative reactive power as well.</p>
5825	AM Reference VQ0	AnalogManager 10.02 ONE 10.01 ZERO 0.0 02.01 LM FALSE 02.01 LM FALSE Pass through	<p>AnalogManager which provides the shifting of the x-axis. It is named VQ0.</p> <p>Through this value the reference mains voltage level Point 1 can be shifted. Refer to drawing.</p> <p>The value determines the point where the reactive power setpoint matches 0 kvar.</p> <p>Analog result of AnalogManager 81.31 AM Reference VQ0</p> <p>Binary result of AnalogManager 81.31 AM Reference VQ0</p>
5827	Q(V) voltage dead band	0.00 to 10.00% [0.00%]	<p>The dead band for the mains voltage relates to the calculation of a new reactive power reference. If the mains voltage is higher/lower as the previous mains voltage +/- hysteresis the "new value" will be used for the reactive power calculation.</p>
1897	Q(V) setpoint filter	0.0 to 99.9 s [10.0 s]	<p>The PT1-filter for the reactive power characteristic Q(V) can be configured here. The parameter stands for the 3 times tau value of a PT1 element. (see drawing). That means the configured time</p>

ID	Parameter	Setting range [Default]	Description
			<p>defines when 95% of the original setpoint jump is reached.</p> <p>Note: Input 0.0s disables the filter influence.</p>

Interface reference setpoint VQ0

AnalogManager variable "05.46 VQ0 reference"

No.	Description	Value	Meaning
512	Control 10	INT16	<p>Interface reference value VQ0. Resolution (1/100)</p> <p>VQ0: The "starting" value is 1.00.</p> <p>The value is limited according to the configuration setting.</p>

Analog source: Interface reference setpoint VQ0

This can be picked up with the AnalogManager variable "05.46 VQ0 reference"

Visualization Q(V) reactive power characteristic

Actual value V/Vc ID10353

Q/Pinst reference ID 10347

QV reference [kvar] ID 10359

Configuration Test possibility for reactive power Q(V) characteristic

For test purposes it is possible to configure a "Test mains voltage" which is passed to the Q(V) characteristic instead of the real mains voltage measurement.

ID	Parameter	Setting range [Default]	Description
5828	Enable mains test voltage	On [Off]	<p>For test purposes, use the mains test voltage instead of the measured mains voltage. This function is temporarily enabled.</p> <p>On: The mains test voltage is used for Q(V) reactive power characteristic. This function is reset after 1 hour automatically.</p> <p>Off: The test voltage is disabled and the measured mains voltage is used.</p> <p>Note: Only in ToolKit!</p>

4 Configuration

4.4.4.2.6.2 Reactive Power Q(P)

ID	Parameter	Setting range [Default]	Description
5829	Mains test voltage	50 to 150% [100%]	The Q(V) function uses the mains test voltage for the calculation of the reactive power reference. Note: Only in ToolKit!

4.4.4.2.6.2 Reactive Power Q(P)

General notes

The FNN VDE-AR-N 4105 / 4110 requests different methods for reactive power control during mains faults to stabilize the mains. This method determines a reactive power based on the actual power output of the generator. The reactive power is controlled in relation to the actual active power. Maximal 10 reference points define the curve. The space between the points are linear interpolated. The tolerance band for the configured curve is +/- 2%

Function

Through the input of up to 10 points a reactive power characteristic can be formed.

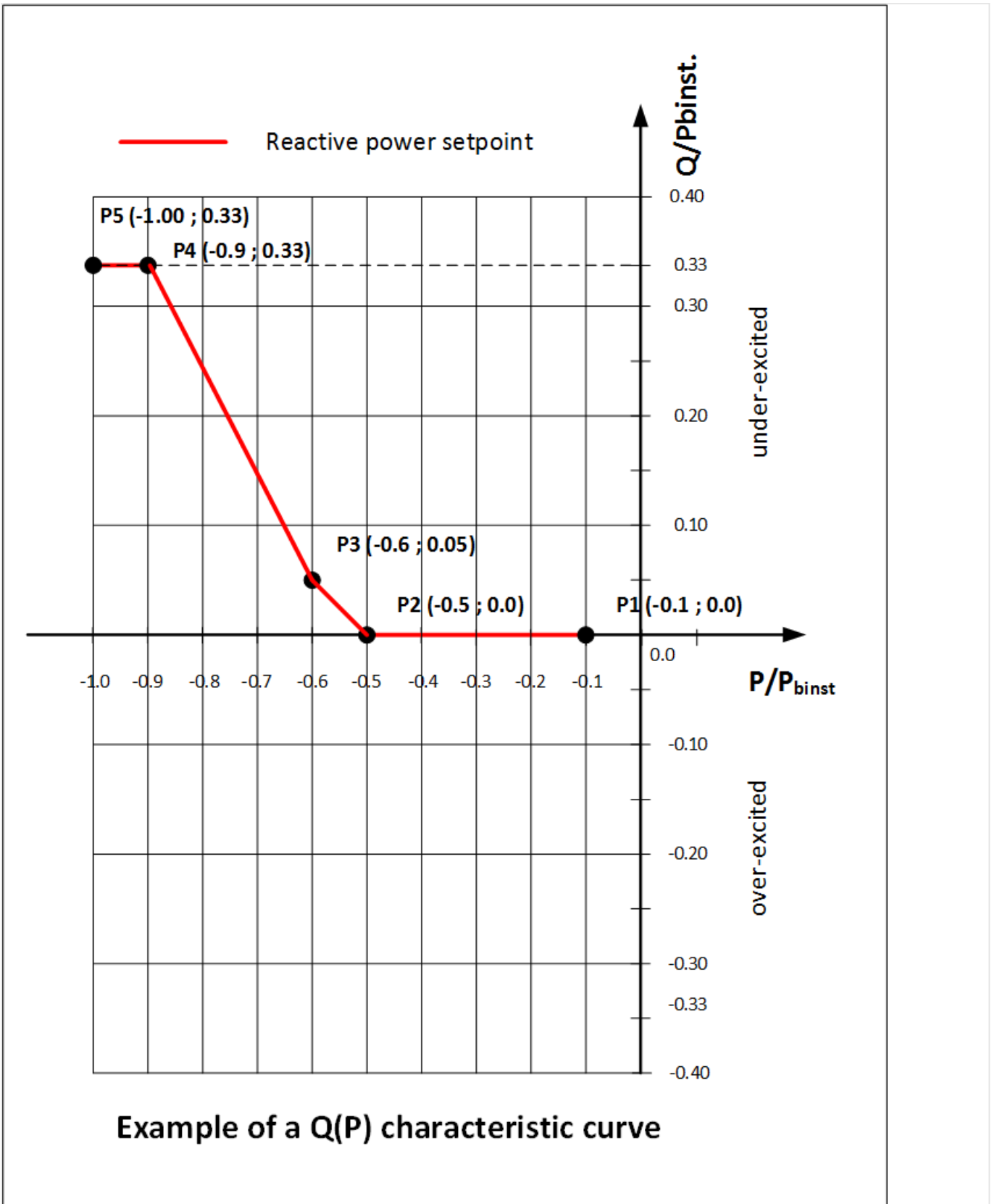

Fig. 193: Example of a Q(P) characteristic with 5 points

4 Configuration

4.4.4.2.6.2 Reactive Power Q(P)

ID	Parameter	Setting range [Default]	Description
5831	P/Pinst. point 1	0	Configuration points (reference points 1 to 10 with relation active power/active power installed (P/Pinst) and rated reactive power in relation to active power installed (Q/Pinst) P: Range 0.00 .. 1.50 Format 0.00
5832	Q/Pinst. point 1	0	
5833	P/Pinst. point 2	0.1	
5834	Q/Pinst. point 2	0	
5835	P/Pinst. point 3	0.2	
5836	Q/Pinst. point 3	0	
5837	P/Pinst. point 4	0.3	
5838	Q/Pinst. point 4	0	
5839	P/Pinst. point 5	0	
5840	Q/Pinst. point 5	0	
5841	P/Pinst. point 6	0.5	
5842	Q/Pinst. point 6	0	
5843	P/Pinst. point 7	0.6	
5844	Q/Pinst. point 7	0.05	
5845	P/Pinst. point 8	0.9	
5846	Q/Pinst. point 8	0.33	
5847	P/Pinst. point 9	1	
5848	Q/Pinst. point 9	0.33	
5849	P/Pinst. point 10	1.5	
5850	Q/Pinst. point 10	0.33	
1898	Q(P) setpoint filter	0 to 99.9s [10.0 s]	The PT1-filter for the reactive power characteristic Q(P) can be configured here. The parameter stands for the 3 times tau value of a PT1 element. (see drawing). That means the configured time defines when 95% of the original setpoint jump is reached. Note: Input 0.0s disables the filter influence.

Visualization Q(P) reactive power characteristic

Actual value P/Pinst ID10354

Q/Pinst reference ID10349

QP reference [kvar] ID10350

4.4.4.2.6.3 Reactive Power Q(V) limit

Introduction

The FNN VDE-AR-N 4105 / 4110 requests different methods for reactive power control during mains faults to stabilize the mains.

This method determines a reactive power setpoint deviation based on the mains voltage. The curve here is defined with four points. The value pairs of point 2 and point 3 can be influenced through an offset value remotely.

This is a way to shift the dead band into a reactive power flow zone. The network provider can influence the basic reactive power flow remotely.

Function

This procedure of running different reactive power values over the voltage is based on four point:

- Point 1 is defined as the reference voltage on which the lagging reactive power flow shall be limited (max. over-excitation). Example in drawing [V/VC 0.94 ; Q/Pbinst -0.33]
- Point 2 is defined as the lowest reference voltage at which the reactive power flow is zero. Example in drawing [V/VC 0.96 ; Q/Pbinst 0.00]
- Point 3 is defined as the highest reference voltage at which the reactive power flow is zero. Example in drawing [V/VC 1.04 ; Q/Pbinst 0.00]
- Point 4 is defined as the reference voltage on which the leading reactive power flow shall be limited (max. under-excitation). Example in drawing [V/VC 1.06 ; Q/Pbinst 0.33]

Furthermore the function provides the capability to shift point 2 and point 3 so that the dead band is shifted into a reactive power flow zone. With this setting the network provider can relative simple shift the reactive power flow (leading or lagging) in the usual voltage range. This helps to compensate any local situations from remote.

Finally, through a test function, the function gives the operator the chance to simulate different mains voltages to observe if the reactive power flow is being maintained properly.

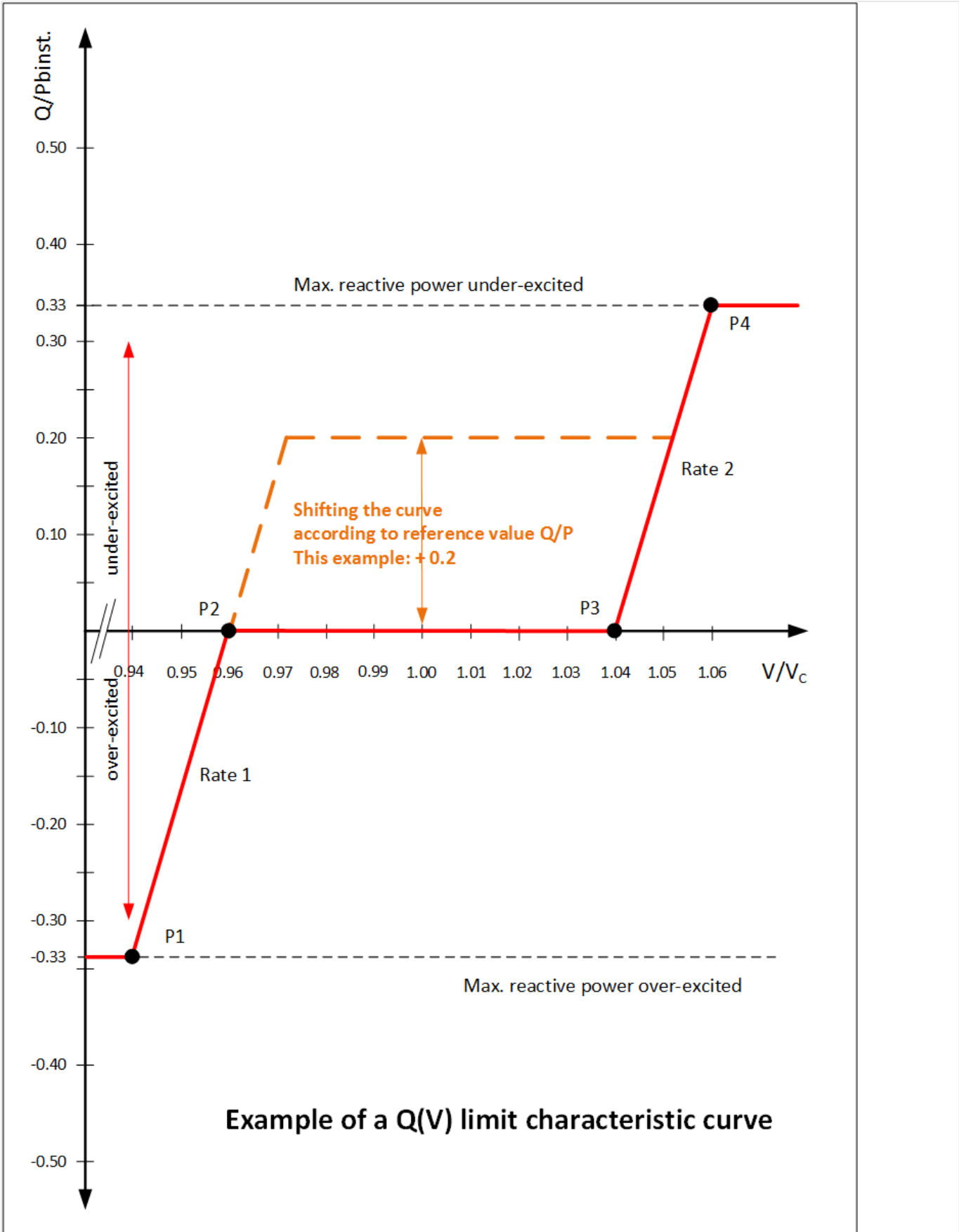

Fig. 194: Example of a Q(V) limit characteristic

ID	Parameter	Setting range [Default]	Description
6912	V/Vc point 1	0.94	<p>Configuration points (reference points 1 to 4) with voltage level in relation to the supply voltage (Vc) and the reactive power in relation to the installed active power from the power generation device. The installed active power is normally the rated power.</p> <p>V: Range 0.00 to 1.50 Format 0.00</p> <p>Q: Range -0.5 to 0.50 Format 00.00</p>
6913	Q/Pinst. point 1	-0.33	
6914	V/Vc point 2	0.96	
6915	Q/Pinst. point 2	0	
6916	V/Vc point 3	1.04	
6917	Q/Pinst. point 3	0	
6918	V/Vc point 4	1.06	
6919	Q/Pinst. point 4	0.33	
1899	Q(V) limit setpoint filter	0 to 99.9 s [10.0 s]	<p>The PT1-filter for the reactive power characteristic Q(V) limit can be configured here. The parameter stands for the 3 times tau value of a PT1 element. (see drawing). That means the configured time defines when 95% of the original setpoint jump is reached.</p> <p>Note: Input 0.0s disables the filter influence.</p>
6908	AM Q/P reference offset	AnalogManager 10.02 ONE 10.01 ZERO 0.0 02.01 LM FALSE 02.01 LM FALSE Pass through	<p>This value defines the offset for the reference points 2 and 3.</p> <p>AM Q/P reference offset 81.32</p> <p>Analog result of AnalogManager LM Q/P reference offset 81.32</p> <p>Binary result of AnalogManager</p>

Interface reference setpoint Q/P limit offset

AnalogManager variable "05.47 Interface QP offset"

No.	Description	Value	Meaning
513	Control 10	INTEGER16	<p>Interface reference value Q/P offset. Resolution (1/100)</p> <p>Q/P offset: The "starting" value is 0.</p> <p>The value is limited according to the configuration setting.</p>

Analog source: Interface reference setpoint Q/P offset

AnalogManager variable "05.47 Interface QP offset"

Visualization Q(V) limit reactive power characteristic

Actual value V/VC ID10355

Q/Pinst reference ID 10351

QV reference [kvar] ID 10352

Configuration Test possibility for reactive power Q(V) limit characteristic

For test purposes it is possible to configure a "Test mains voltage" which is passed to the Q(V) limit characteristic instead the real mains voltage measurement.

The parameter Ids are the same like for the Q(V) reactive power characteristic.

4.4.4.3 Load Share Control

CAUTION!



Load Share Communication

For correct load share communication all load sharing gensets in the system must actively use the same load share communication interface (and network)!

Load share communication is defined by parameter »Load share interface« 9924 (CAN or Ethernet) and others.

Please see settings at

- [Parameter / Configuration / Configure application / Configure controller / Configure load share]
- Chapter "4.4.4.3.7 Parameters"

The easYgen performs proportional load and/or var sharing. This means each generator will share the load at the same percentage level of the generator rated power when paralleled against the mains, in an islanded operation with multiple generators paralleled, or when re-synchronizing the common bus to the mains.

Also in islanded operation the load ramp rate parameters 5522 and 5622 are used to ramp a new generator onto the other.



If not enough nominal power on the busbar is available, from now on the ramping of an engine onto others will be interrupted but the load sharing will be executed immediately. This is to avoid overloading of already online generators.

Proportional load/var sharing will not be performed when the easYgen has the GCB closed and is in the constant power/base load mode.

A system can consist out of 32 gensets which are controlled by a single easYgen.

In GCB/GC mode **A13** it is possible to expand the system to more than 32 gensets.

4.4.4.3.1 Mains Parallel Operation With Mains Interchange Real Power Control (Import/Export)

The easYgen controllers maintain the real load level on the individually controlled generators at a level so that the real power setpoint at the mains interchange remains at the configured setpoint. The real power setpoint for the mains interchange must be configured identically for each easYgen.

The easYgen controller communicates with other controls in the system via a CAN bus. This enables the controllers to adjust the real power generated by the generator while remaining within the rated power of the generator. A smaller generator will contribute less real power as compared to a large generator, but they will both be utilized to the same capacity factor. An example of this would be a 100 kW generator with a configured 1000 kW generator and a mains interchange of 825 kW. The 100 kW generator would contribute 75 kW and the 1000 kW generator would contribute 750 kW or both generators would be at 75% of their rated capacity.

How the reactive power handling is executed depends the PF/kvar setpoint mode. Two setpoints ([↩ 5743](#) and [↩ 5744](#)) are available. Each setpoint allows the modes:

- Gen PF
- Mains PF
- Mains Import kvar
- Mains export kvar

In PF modes the reactive load sharing is not performed when operating in parallel with the mains. Reactive power control will be defined by the configured power factor setpoints ([↩ 5620](#) or [↩ 5621](#)) of the individual controllers. If the power factor controller setpoint is configured as +0.950, the easYgen will proportionally share the real load with all generators in parallel with the mains while controlling the reactive power at a 0.95 inductive (lagging) power factor regardless of the what power factor the mains is operating at.

The parameter "Active power Load share gain" (parameter [↩ 4522](#)) can be used to define the priority of the reference variable for real power sharing (real power at interchange). A higher configured value influences the control more towards maintaining the real power setpoint for the interchange. A lower configured value influences the control more towards maintaining real power sharing between units.



The parameter "React. power Load share gain" (parameter [↩ 4543](#)) has no influence here.

In kvar modes the reactive load sharing is performed when operating in parallel with the mains. Mains import/export kvar control at the interchange point will be determined by the configured int. kvar setpoints ([↩ 5745](#) or [↩ 5746](#)) of the individual controllers.

4.4.4.3.2 Islanded Operation In Parallel

The easYgen controllers maintain the voltage and frequency of the individually controlled generators at a constant level. This makes it imperative that the voltage and frequency setpoints are configured identically for each easYgen.

The easYgen controller communicates with other controls in the system via a CAN bus. This enables the controllers to adjust the real power generated by the generator while remaining within the rated power of the generator. A smaller generator will contribute less real power as compared to a large generator, but they will both be utilized to the same capacity factor.

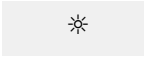

Example

An example of this would be a 100 kW generator and a 1000 kW generator with an 825 kW load. The 100 kW generator would contribute 75 kW and the 1000 kW generator would contribute 750 kW or both generators would be at 75% of their rated capacity.

The reactive power will be shared proportionally among all generators involved.

The parameter "Active power Load share gain" (parameter [↩ 4522](#)) can be used to define the priority of the reference variable for real power sharing. A higher configured value influences the control more towards frequency control. A lower configured value influences the control more towards real power sharing.

The parameter "Active power Load share gain" (parameter [↩ 4522](#)) can be used to define the priority of the reference variable for real power sharing. A higher configured value influences the control more towards frequency control. A lower configured value influences the control more towards real power sharing.

4.4.4.3.3 Re-synchronization Of The Busbar To The Mains

The system is operating as an islanded system, for synchronization to be performed the voltage and frequency differentials of the mains and bus must be within the configured windows.

The bus frequency reference point is dictated by the measured mains frequency and the configured frequency differential (+ slip frequency setpoint offset (parameter [↩ 5502](#))).



Example

If + slip frequency setpoint offset = 0.2 Hz, the easYgen will calculate the bus frequency reference point as:

- [measured mains frequency] + [slip frequency setpoint offset] = bus frequency reference point

A practical example of this would be:

- The monitored mains frequency is 60 Hz
- Configured + slip frequency setpoint offset = 0.2 Hz
- [60 Hz] + [0.2 Hz] = 60.2 Hz bus frequency reference point

The differential voltage is configured as a window. The monitored voltage from the potential transformers secondary for the mains and the bus must be within the configured voltage differential limit in relation to the rated voltage configuration.

This means that the voltage window dV [%] is in relation to the rated voltage configuration [%].

When the monitored bus frequency and voltage are within the configured differential limits, the "Command: close MCB" relay will enable, closing the MCB, and the system will be paralleled to the mains.

4.4.4.3.4 Prerequisites

All easYgen controllers connected to the system must have rated system frequencies and breaker logic configured identically and the parameter "Active power load share" (parameter [↩> 5531](#)) or "Reactive power load share" (parameter [↩> 5631](#)) must be enabled.

4.4.4.3.5 Load-Share Interface

The easYgen utilizes a peer relationship between units to control the system. This permits for parallel applications of up to 32 generators.

The current load-share interface is selected by parameters [↩> 9924](#) and [↩> 11986 LM 86.13](#).



For set-up of the load-share communication refer to [↩> "3.4.5 Ethernet Interface \(incl. Remote Panel\)"](#) for information about the CAN bus connection or to [↩> "4.7.5 Ethernet Interfaces"](#) for Ethernet

4.4.4.3.6 Load Sharing

The "Active/Reactive power load share" together with the "Active/Reactive power load share gains" determine if and how a generator performs real power or frequency control when paralleled with other generators in an islanded operation.

In the illustrated control system, it must be noted that each control calculates the mean utilization factor of all controls from the data transmitted via the selected bus and then compares this with its own utilization factor. The utilization factor is compared with the reference variable and results in a new reference variable setpoint. Frequency and real power control are carried out simultaneously in these controls (corresponding to the reference variable).

Frequency control is carried out via the measured voltage/frequency of the voltage system. The MPU is used merely for monitoring functions, or is available as a control value to the secondary controller.

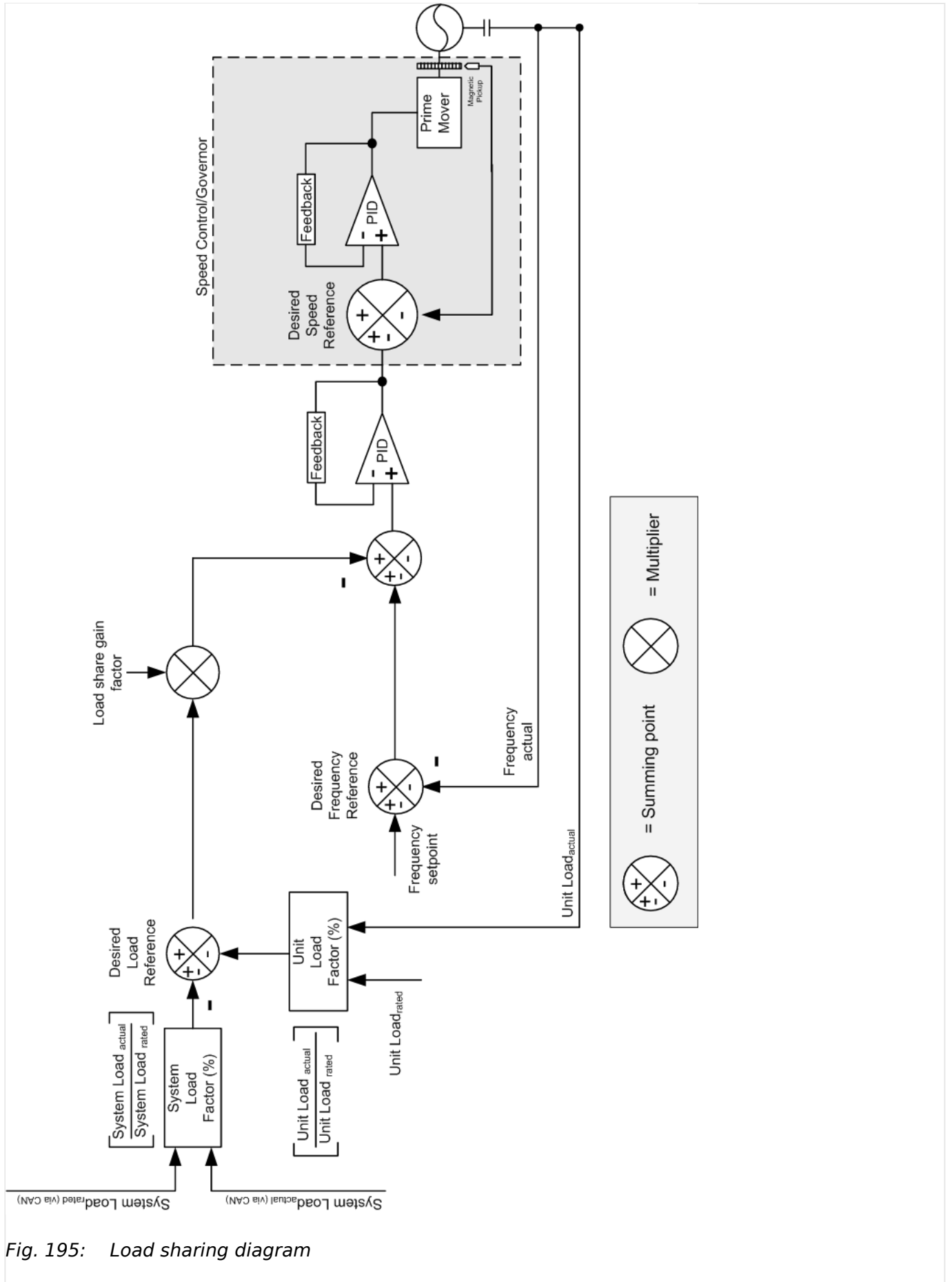

Fig. 195: Load sharing diagram

4.4.4.3.7 Parameters

ID	Parameter	CL	Setting range [Default]	Description
9924	Load share Interface	2		The interface, which is used for transmitting the load share data is configured here.
			[CAN]	Use CAN interface 3.
			Ethernet A	Use Ethernet A interface.
			Ethernet B/C	Use Ethernet B or C interface.
			CAN/EthA by LM	Use CAN interface 3 but switch to Ethernet A by TRUE of LM 86.13 (described below).
			CAN/Ethernet A	Use CAN and Ethernet A redundant
			Ethernet B	Use Ethernet B interface.
	Off	Deactivate load share interface.		
11986	LS interface Ethernet A	2	Determined by LogicsManager 86.13 [(02.01 & 1) & 1] = 11987	Load share interface switch if parameter ↪ 9924 is configured to "CAN/EthA by LM". TRUE: Use Ethernet A interface FALSE: Use CAN interface 1
2442	Load share timeout event	2	[Off]	Loadshare timeout events are disabled.
			On	Loadshare timeout events are enabled. If a loadshare message was not received within a defined time, a loadshare timeout event will be shown in the Event History.
5531	Active power load share	2	[On]	Active power load share is enabled. When multiple generators are operating in parallel, the real power is shared proportionally.
			Off	Active power load share is disabled
4522	Active power load share gain	2	0.01 to 9.99 [1.25]	This parameter defines the impact of the active power load sharing error signal on the frequency/load controller setpoint. The active power load share gain can be adjusted between 0.01 to 9.99. The load controller setpoint is considered, if an export import power control to mains is maintained. With a higher value the active load sharing has a higher correction factor in the regulation.
				Notes This parameter replaces the former existing weighting factor on non-XT easYgen (ID 5530). The

ID	Parameter	CL	Setting range [Default]	Description
				default gain 1.25 relates to the 50% value.
5631	Reactive power load share	2	[On]	Reactive power load share is enabled. When multiple generators are operating in parallel, the reactive power is shared proportionally.
			Off	Reactive power load share is disabled
4543	React. power load share gain	2	0.01 to 9.99 [1.25]	<p>This parameter defines the impact of the reactive power load sharing error signal on the voltage/ reactive load controller setpoint. The reactive power load share gain can be adjusted between 0.01 to 9.99.</p> <p>The reactive load controller setpoint is considered, if an export/import reactive power control to mains is maintained.</p> <p>With a higher value the reactive load sharing has a higher correction factor in the regulation.</p>
				<p>Notes</p> <p>This parameter replaces the former existing weighting factor of non-XT easYgen (ID 5630). The default gain 1.25 relates to the 50% value.</p>



High data volume on communication ports can cause low HMI display operation dynamic.

Recommendation:

Reduce data transfer volume on CAN bus. This can be done with parameter [9921](#) »Transfer rate LS fast message«.

A general action to reduce data volume on CAN1 is disabling the TPDO1 data protocol if it is not used. Therefore navigate to parameter [9600](#) »COB-ID« and enter "80000000" via front panel or "2147483648" via ToolKit.

For more information how to reduce bus load see [4.4.4.3.6 Load Sharing](#).

Relation "... factor" <> "... gain"



This ... gain parameter replaces the former existing (%) ... factor of non-XT easYgen. The table below shows the relation between the old and new values.

The used defaults 1.25 / 50% ensure backward compatibility.

Weighting %	LS Gain
10	2.25
20	2
30	1.75
40	1.5
50	1.25
60	1
70	0.75
80	0.5
90	0.25
98	0.05

4.4.4.3.8 Load Share Control Grouping

Load sharing with several gensets is possible for a supply of several split busbars. Each of this individual groups is called a segment.

Up to four segments can be managed easily for load share by LogicsManager!



In the application breaker mode GCB/LSx the LogicsManager equations described below are used to handle even more complex easYgen/LSx applications. Please read general information first and then continue with [“4.4.4.3.9 Segment Number in GCB/LSx mode”](#).

General

A group breaker splits the busbar in a way that some gensets supply one busbar and some supply another one. However, it is necessary to group the gensets, which supply the same busbar.

The designer of a busbar system gives all individual bus bars an own number: The Segment Number for the easYgen is defined with ID 1723. Each easYgen is connected with its GCB on one of these segments.

The configured segment number can be changed to one of three alternative segment numbers by three LogicsManager equations. These LogicsManager equations stand for the segment numbers 2, 3, or 4. They are usually controlled by circuit breaker reply auxiliary contacts. This is finally the segment number the easYgens interacts with.

* **Example**

Six gensets (G1 through G6) supply a system with two group breakers (A, B) as shown in . All gensets have the same segment number configured #1 (parameter \hookrightarrow 1723)

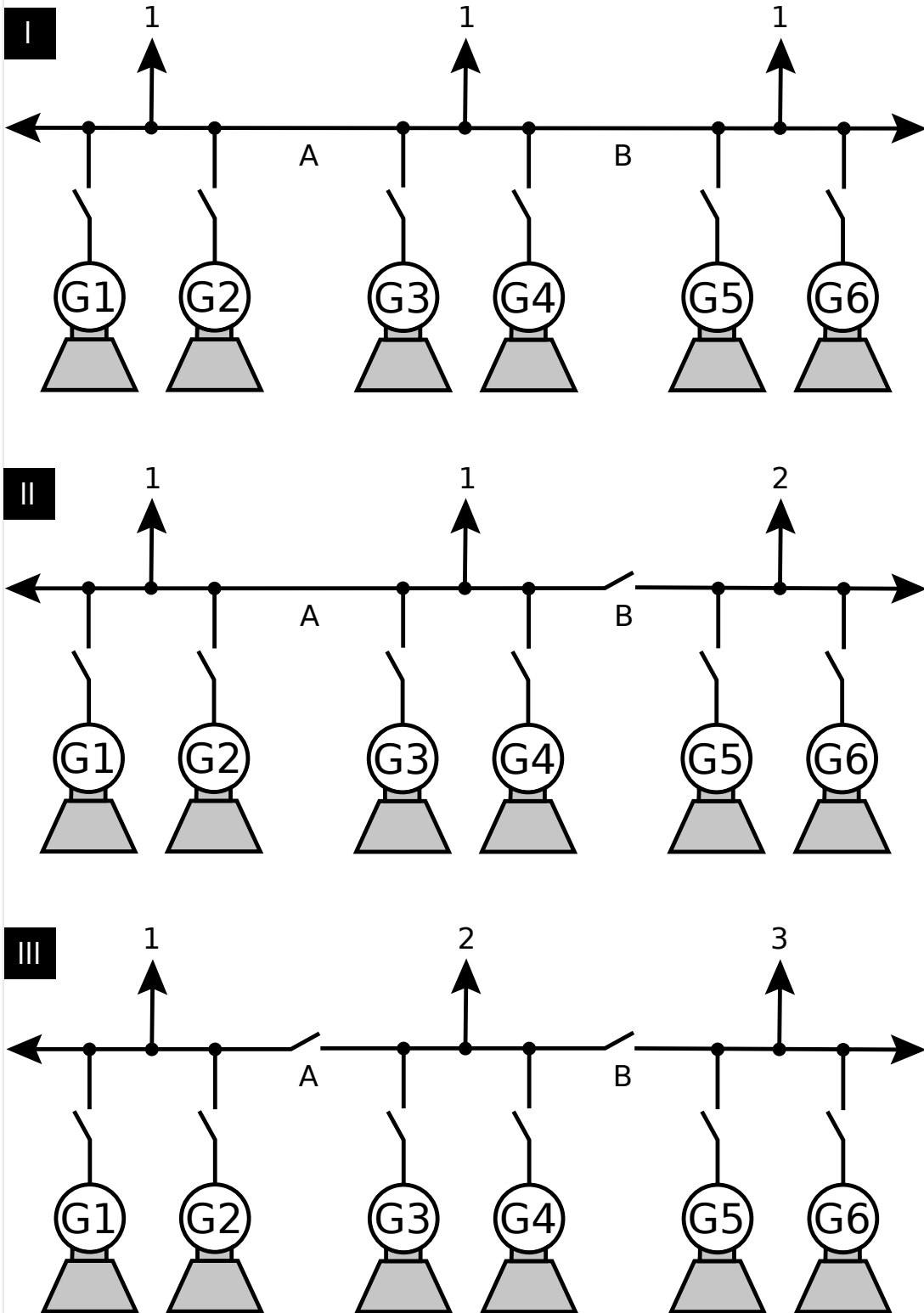

Fig. 196: Load sharing - grouping

ID	Parameter	CL	Setting range [Default]	Description
1723	Segment number	2	1 to 32 [1]	The genset is assigned a load share segment number with this parameter. This segment number may be overridden by the following parameters ↩ 12929 , ↩ 12928 , and ↩ 12927 .
12929	Segment no.2 act.	2	Determined by LogicsManager 86.87	Once the conditions of the LogicsManager have been fulfilled, this genset is assigned load share segment number 2 (this parameter has priority over parameters ↩ 12928 and ↩ 12927).
			[(0 & 1) & 1]	Notes For information on the LogicsManager and its default settings see ↩ "9.3.1 LogicsManager Overview" .
12928	Segment no.3 act.	2	Determined by LogicsManager 86.88	Once the conditions of the LogicsManager have been fulfilled, this genset is assigned load share segment number 3 (this parameter has priority over parameters ↩ 12927).
			[(0 & 1) & 1]	Notes For information on the LogicsManager and its default settings see ↩ "9.3.1 LogicsManager Overview" .
12927	Segment no.4 act.	2	Determined by LogicsManager 86.89	Once the conditions of the LogicsManager have been fulfilled, this genset is assigned load share segment number 4.
			[(0 & 1) & 1]	Notes For information on the LogicsManager and its default settings see ↩ "9.3.1 LogicsManager Overview" .
5568	Mode ext. load share gateway	2		The operation mode for the external Woodward Load Share Gateway (LSG) is configured here.
			[0]	Off
			1	<i>Woodward EGCP-2</i> RS-485 (P & Q)
			2	<i>Woodward SPM-D</i> R = 4.99k P : 0 – 4 V (0 to 100%) Q : 0 – 5 V (-85% to +85%) <i>Woodward MFR 15</i> R = 4.99k P : 0 – 4 V (0 to 100%)
			3	<i>Woodward 2301 A</i>

4 Configuration

4.4.4.3.9 Segment Number in GCB/LSx mode

ID	Parameter	CL	Setting range [Default]	Description
				R = 54.90k P : 0 – 3 V (0 to 100%)
			4	<i>Caterpillar LSM</i> R = 25.00k P : 0 – 3 V (0 to 100%)
			5	<i>Cummins PCC 3100, 3200, 3201, 3300</i> R = 5.00k P : 0 – 2.5 V (-14.1 to 121.9%) Q : 0 – 2.5 V (-16.7% to +125.3%)
			6	<i>POW-R-CON</i> R = 20.67k P : 0 – 5 V (0 to 100%)
			7	Prepared R = 25.00k P : -5 – +5 V (0 to 100%)
			8	Prepared R = 25.00k P : 0 – 7 V (0 to 100%)
			9	<i>Woodward GCP/MFR</i> CAN (P & Q)1 – easYgens and GCP/MFR share the same CAN bus
			10 to 16	Not defined
				Notes Refer to the Load Share Gateway (LSG) Manual 37442 for security guidelines and detailed information about the configuration. R : Internal resistance P : Range for active power Q : range for reactive power

4.4.4.3.9 Segment Number in GCB/LSx mode

In the application breaker mode GCB/LSx the Segment Number (ID 1723) informs the LSx algorithm about the dedicated segment of the particular easYgens. Finally the LSx algorithm determines for each easYgen on which segment number it has to interact with others.

In cases, where different GCBs shall be served, the operator can switch over the Segment LogicsManager equations between up to four dedicated segments, three of them predefined: The Segment Number (ID 1723) or the segment number 2, 3, or 4.

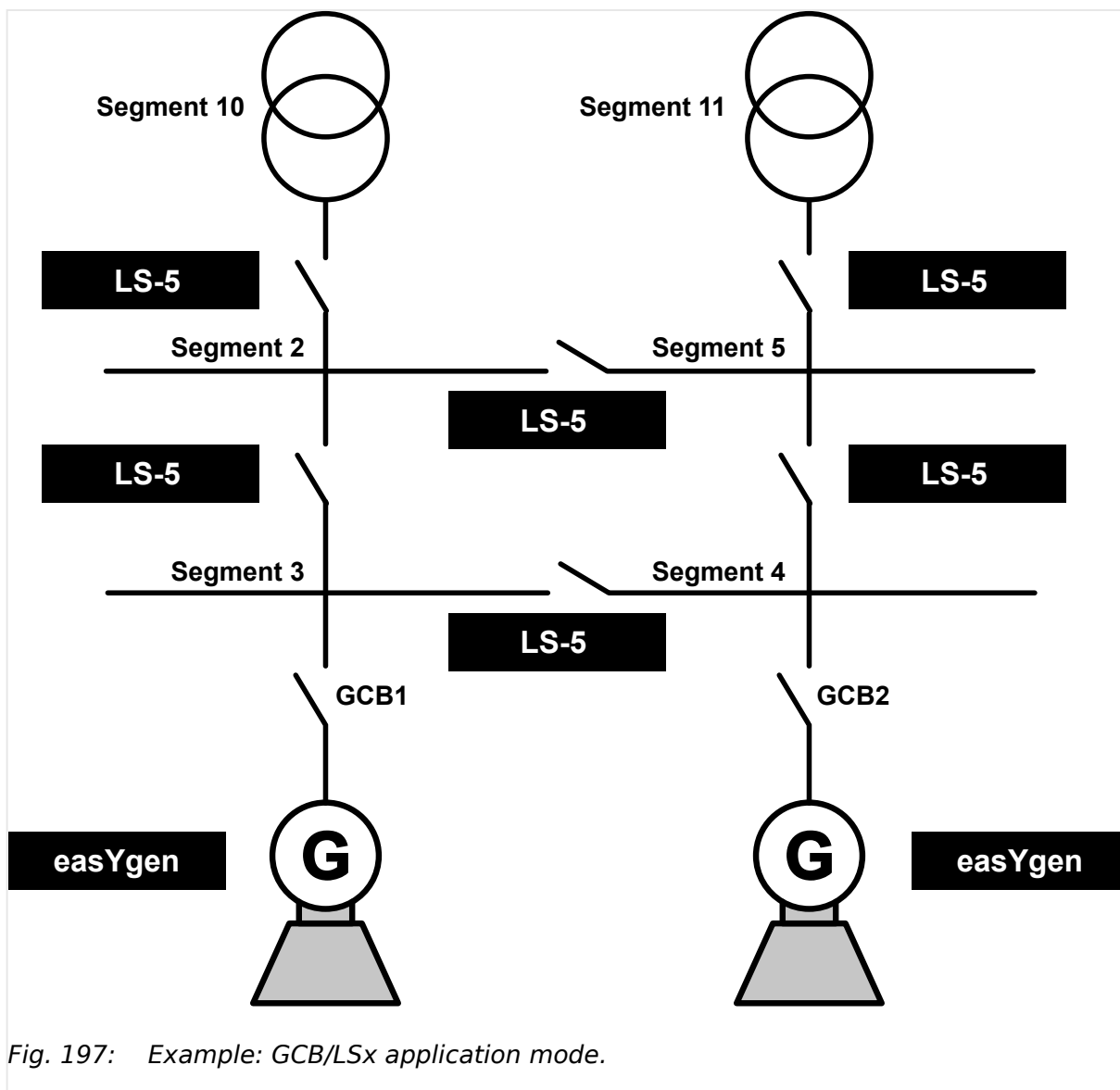

Fig. 197: Example: GCB/LSx application mode.

In cases, where different GCBs shall be served, the operator has to switch the correct segment number before he is closing the according GCB. Only one GCB per easYgen is allowed to be closed.

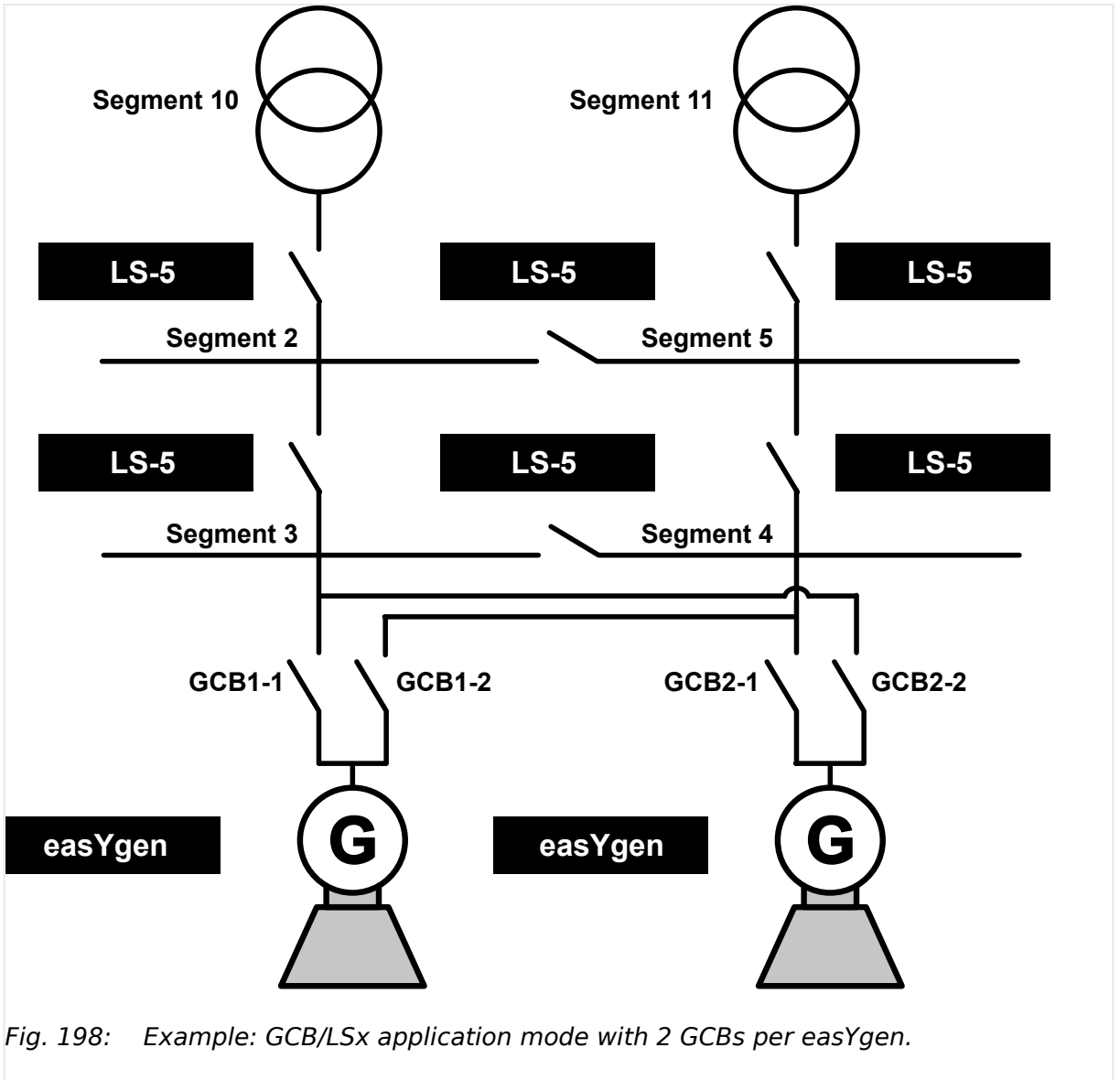
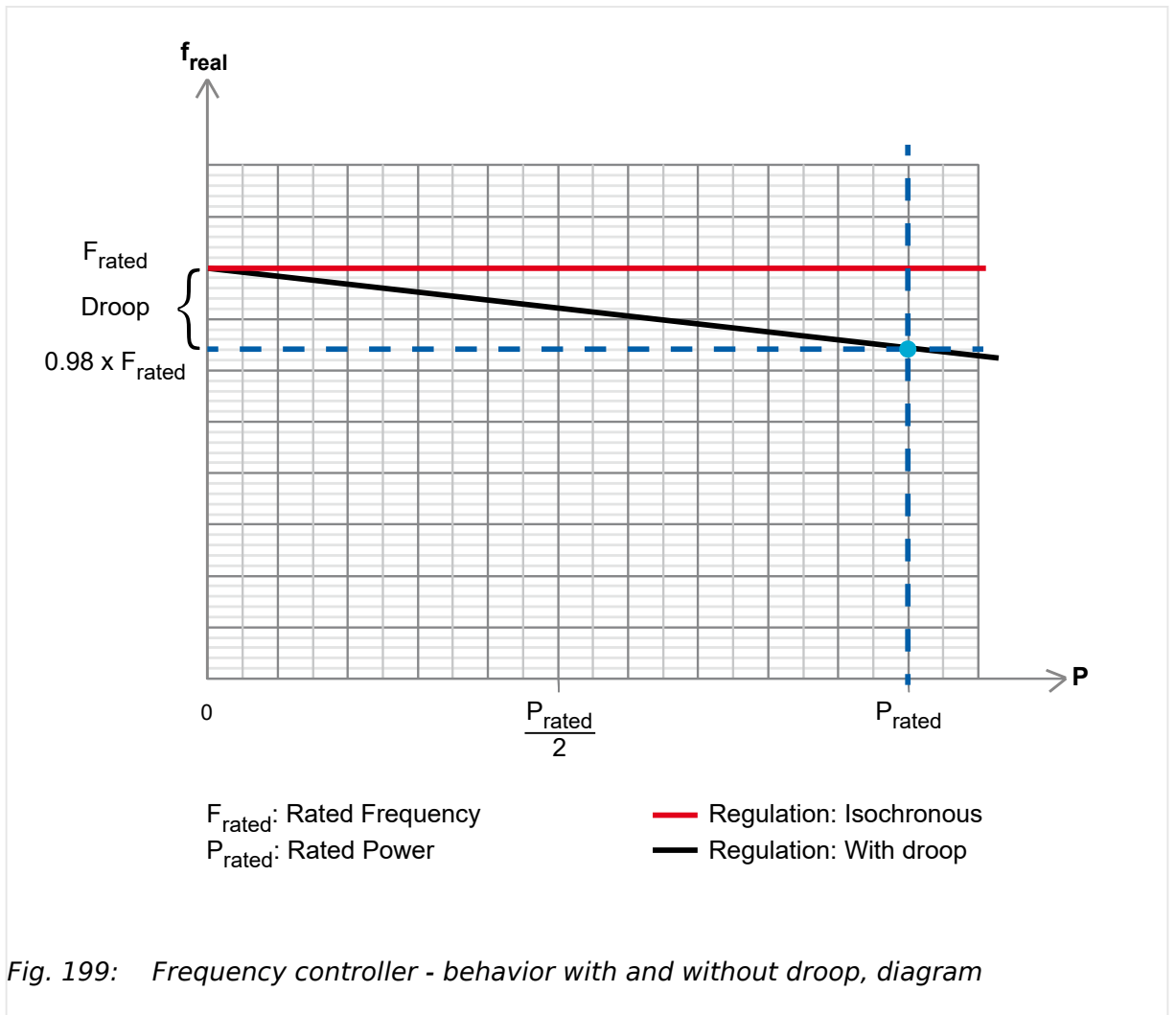

Fig. 198: Example: GCB/LSx application mode with 2 GCBs per easYgen.

4.4.4.3.10 Droop

The isochronous running frequency or voltage controllers keep the desired frequency or voltage set point independent on the real or reactive power of the generator.

The **frequency controller** with activated droop behavior (LogicsManager ID [12904](#)) reduces the desired frequency setpoint dependent on the active power of the generator (ID [1752](#)). In case of a full loaded engine the frequency setpoint will be reduced with the percentage value (ID [5504](#)) related to rated frequency.



The resulting frequency setpoint is calculated as follows: $F'_{Set} = F_{Set} - (P_{real} * (F_{rated} * \text{droop factor}) / P_{rated})$

The **voltage controller** with activated droop behavior (LogicsManager ID [12905](#)) reduces the desired voltage setpoint dependent on the reactive power of the generator (ID [1758](#)). In case of a full reactive loaded generator the voltage will be reduced with the percentage value (ID [5604](#)) of the rated frequency.

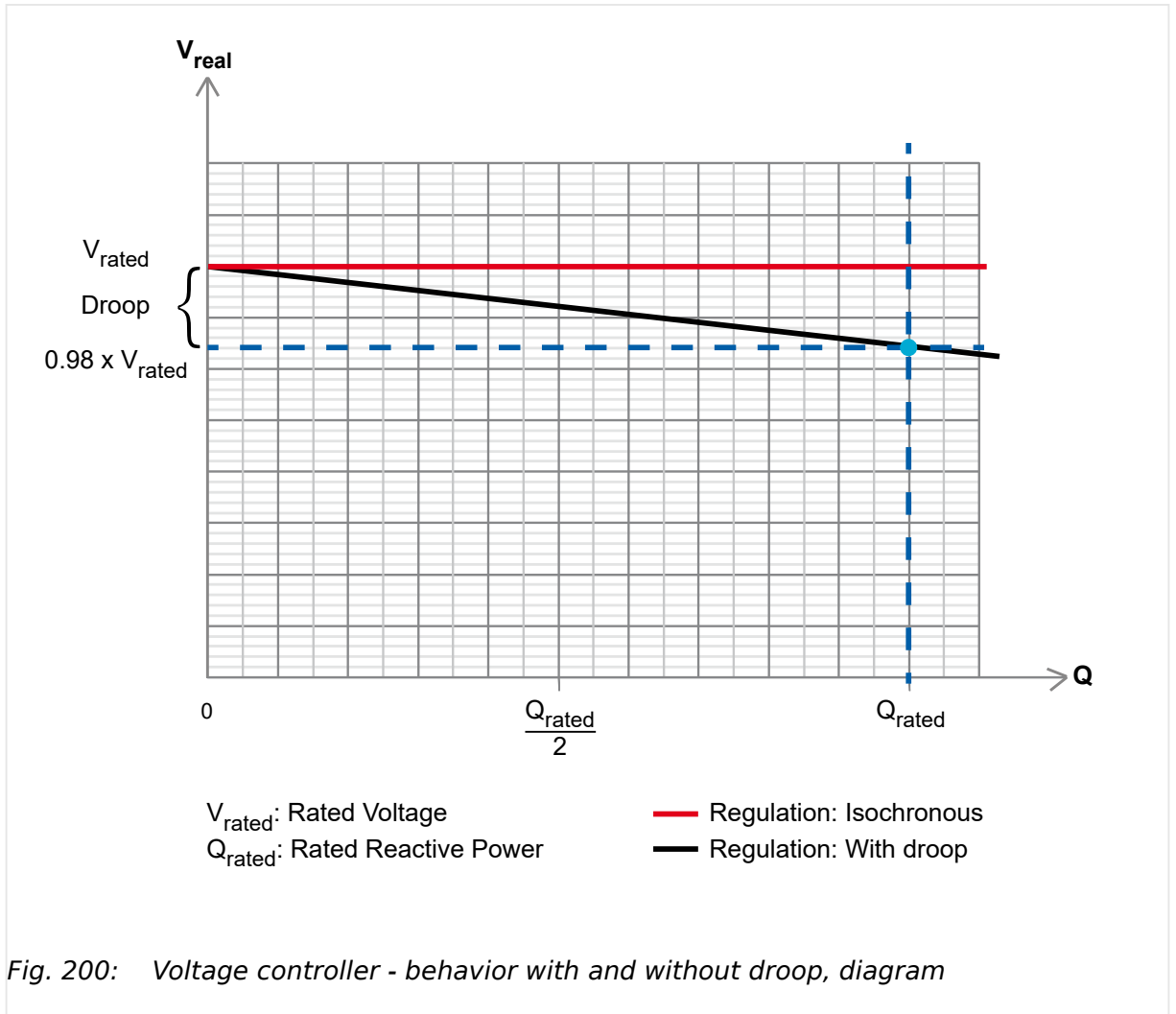

Fig. 200: Voltage controller - behavior with and without droop, diagram

The resulting voltage setpoint is calculated as follows: $V_{Set} = V_{Set} - (Q_{real} * (V_{rated} * droop\ factor) / Q_{rated})$

Function Droop Tracking

The droop tracking for frequency/voltage control is implemented such that when the control is switched to frequency/voltage control with droop the frequency/voltage real value does not change at the current active/reactive load. This is provided by pre-calculating a setpoint offset, which is needed to hold rated frequency/voltage at present load.

This is a feature in applications where for example the load sharing over communication interface gets lost and the number of generators remains the same.

Droop Tracking On/Off

The easYgen allows disabling the droop tracking for frequency and voltage generally. This makes sense in applications where the number of generators can vary during running in droop mode.

Load sharing in Droop mode On/Off

Multiple easYgens are load sharing under each other, if they run islanded from mains or they control export/import power at a common interchange point. For dynamic reasons it makes sense to disable the load sharing, when the easYgens running in droop or can fall into droop mode (Missing member case).

ID	Parameter	CL	Setting Range [Default]	Description
5747	Droop tracking	2	[On]	The frequency and voltage setpoint offset is pre-calculated to hold the frequency and voltage, when control is switched into droop.
			Off	The setpoint offset is always zero.
5748	Load sharing in droop mode	2	[On]	As long the load sharing function is enabled, it is done in droop mode too.
			Off	The load sharing is generally disabled in droop mode.

Table 69: Droop related parameters

4.4.4.4 Frequency Control

Notes on kick impulse function

Frequency control provides a kick impulse function, which issues a pulse if the frequency control deadband (parameter [↩ 5550](#)) is not exceeded and no synchronization could be performed for 20 seconds. The function is enabled, if a synchronization is carried out.

- If the phase angle is between 0° and 180°, a "frequency lower" signal is issued.
- If the phase angle is between 180° and 360°, a "frequency raise" signal is issued.

The pulse duration is 100ms. If the synchronization still fails, another pulse will be issued after 10 seconds.

The following conditions are required for the kick impulse function:

- Frequency control (parameter [↩ 5507](#)) is configured to "3pos controller"
- Synchronization mode (parameter [↩ 5728](#)) is configured to "RUN" or "CHECK" (or "Controlled by LM" and RUN or CHECK enabled by the LogicsManager)



ToolKit: find settings screen

Analog Managers to define input signal of frequency setpoint (1, 2) are available in ToolKit by

- a click from screen/page "Configure frequency control"
 - on the button "Analog manager" in the left sidebar (below permanent buttons) or
 - on two times "next page", or
- search for one of the frequency controlled value shown at the status screen



ToolKit: Trend chart

ToolKit offers a trend visualization accessible by

- a click from screen/page "Configure frequency control"
 - on the button "Trend chart" in the left sidebar (below permanent buttons) or
 - on "next page", or
- search (for parameter)

ID	Parameter	CL	Setting range [Default]	Description
5507	Frequency control	2	[PID analog]	The frequency is controlled using an analog PID controller.
			3pos controller	The frequency is controlled using a three-step controller.
			Off	Frequency control is not carried out.
5097	Freq. control with	2	MPU [Gen.frequency]	<p>Determining the speed source for the frequency controller.</p> <p>MPU: The source for the speed control is the speed input. Usually the connected MPU or the J1939 speed. Refer to ID 15155 Engine speed source" for more information.</p> <p>The rpm value is internally calculated to an Hz value and provided to the frequency controller.</p> <p>Gen.frequency: The electrical frequency in Hz is the source.</p>
				<p>Note: If MPU is enabled check carefully the relationship rpm to electrical frequency. Refer to parameter "1601 Engine rated speed", "1600 Speed input" and "1602 Fly wheel teeth".</p>
5508	Freq. control initial state (Frequency control initial state)	2	0.0 to 100.0% [50.0%]	<p>The value entered for this parameter is the start reference point for the analog output to the speed controller.</p> <p>Notes</p> <p>If the output to the speed control has been disabled, the output will act as a control position reference point.</p>
5510	Proportional gain	2	0.01 to 100.00 [1.00]	<p>The proportional coefficient specifies the gain. By increasing the gain, the response is increased to permit larger corrections to the variable to be controlled.</p> <p>The farther outside tolerances the process is, the larger the response</p>

ID	Parameter	CL	Setting range [Default]	Description
				<p>action is to return the process to the tolerance band.</p> <p>Notes</p> <p>If the gain is configured too high, the result is excessive overshoot/undershoot of the desired value.</p> <p>This parameter is only visible if frequency control (parameter 5507) is configured to "PID analog".</p>
5511	Integral gain	2	0.00 to 100.00 [1.00]	<p>The integral gain identifies the I part of the PID controller.</p> <p>The integral gain corrects for any offset (between setpoint and process variable) automatically over time by shifting the proportioning band. Reset automatically changes the output requirements until the process variable and the setpoint are the same.</p> <p>This parameter permits the user to adjust how quickly the reset attempts to correct for any offset.</p> <p>Notes</p> <p>The integral gain constant must be greater than the derivative time constant. If the integral gain constant is too large, the engine will continually oscillate.</p> <p>If the integral gain constant is too small, the engine will take too long to settle at a steady state.</p> <p>This parameter is only visible if frequency control (parameter 5507) is configured to "PID analog".</p>
5512	Derivative ratio	2	0.01 to 100.00 [0.01]	<p>The derivative ratio identifies the D part of the PID controller.</p> <p>By increasing this parameter, the stability of the system is increased. The controller will attempt to slow down the action of the actuator in an attempt to prevent excessive overshoot or undershoot. Essentially this is the brake for the process.</p> <p>This portion of the PID loop operates anywhere within the range of the process unlike reset.</p> <p>Notes</p> <p>This parameter is only visible if frequency control (parameter 5507) is configured to "PID analog".</p>

4 Configuration

4.4.4.4 Frequency Control

ID	Parameter	CL	Setting range [Default]	Description
				<p>5507) is configured to "PID analog".</p> <p>The default configured controller acts like a PI controller what is the valid D part setting for systems with secondary controllers.</p>
5090	Proportional gain 2	2	0.01 to 100.00 [1.00]	<p>This parameter defines the proportional coefficient that specifies the gain of the 2nd PID controller. By increasing the gain, the response is increased to permit larger corrections to the variable to be controlled. The farther outside tolerances the process is, the larger the response action is to return the process to the tolerance band.</p>
5091	Integral gain 2	2	0.00 to 100.00 [1.00]	<p>This parameter defines the integral gain that identifies the I part of the 2nd PID controller. The integral gain corrects for any offset (between setpoint and process variable) automatically over time by shifting the proportioning band. Reset automatically changes the output requirements until the process variable and the setpoint are the same.</p> <p>This parameter permits the user to adjust how quickly the reset attempts to correct for any offset.</p>
5092	Derivative ratio 2	2	0.01 to 100.00 [0.01]	<p>This parameter defines the D part of the 2nd PID controller. By increasing this parameter, the stability of the system is increased. The controller will attempt to slow down the action of the actuator in an attempt to prevent excessive overshoot or undershoot. Essentially this is the brake for the process. This portion of the PID loop operates anywhere within the range of the process unlike reset.</p>
12990	2nd Frequency PID	2	[02.01 LM FALSE And 02.02 LM TRUE And 02.02 LM TRUE]	<p>This LogicsManager is used to activate the 2nd Frequency PID controller parameter set. If the LogicsManager output is false the 1st Frequency PID controller parameter set is taken.</p> <p>Notes</p> <p>For information on the LogicsManager and its default settings see 9.3.1 LogicsManager Overview.</p>
5550	Deadband	1	0.02 to 9.99 Hz [0.08 Hz]	<p>islanded operation</p> <p>The generator frequency is controlled in such a manner that the measured frequency does not</p>

ID	Parameter	CL	Setting range [Default]	Description
				<p>deviate from the configured setpoint by more than the value configured in this parameter without the controller issuing a frequency raise/lower signal to the frequency control.</p> <p>This prevents unneeded wear on the frequency bias output control or the raise/lower relay contacts.</p> <p>Example</p> <ul style="list-style-type: none"> If the frequency setpoint is 50 Hz and a deadband of 0.5 Hz is configured, the measured generator frequency must exceed 50.5 Hz (50 + 0.5) to issue a lower pulse or fall below 49.5 Hz (50 - 0.5) to issue a raise pulse. <p>Synchronization</p> <p>The generator frequency is controlled in such a manner that the measured frequency does not deviate from the monitored reference (mains or busbar) frequency by more than the value configured in this parameter without the controller issuing a frequency raise/lower signal to the frequency control.</p> <p>This prevents unneeded wear on the frequency bias output control or the raise/lower relay contacts. The value configured for this parameter must be less than the value configured for the df max (maximum frequency differential) for synchronization.</p> <p>Notes</p> <p>This parameter is only visible if frequency control (parameter 5507) is configured to "3pos controller".</p>
5551	Time pulse minimum	1	0.01 to 2.00 s [0.05 s]	<p>A minimum pulse on time must be configured here.</p> <p>The shortest possible pulse time should be configured to limit overshoot of the desired speed reference point.</p> <p>Notes</p> <p>This parameter is only visible if frequency control (parameter 5507) is configured to "3pos controller".</p>
5552	Gain factor	1	0.1 to 10.0	<p>The gain factor K_p influences the operating time of the relays.</p>

4 Configuration

4.4.4.4 Frequency Control

ID	Parameter	CL	Setting range [Default]	Description
			[5.0]	<p>By increasing the number configured in this parameter, the operating time of the relay will be increased in response to a deviation from the frequency reference.</p> <p>By increasing the gain, the response is increased to permit larger corrections to the variable to be controlled. The farther out of tolerance the process is the larger the response action is to return the process to the tolerance band.</p> <p>Notes</p> <p>If the gain is configured too high, the result is excessive overshoot/undershoot of the desired value.</p> <p>This parameter is only visible if frequency control (parameter 5507) is configured to "3pos controller".</p>
5636	Cycle time factor	1	1.0 to 20.0 [1.0]	<p>The cycle time factor adjusts the time between the pulses (pause time).</p> <p>By increasing the cycle time factor, the time between the pulses increases.</p> <p>Notes</p> <p>This parameter is only visible if voltage control (parameter 5507) is configured to "3pos controller".</p>
5553	Expand deadband factor	1	1.0 to 9.9 [1.0]	<p>If the measured generator frequency is within the deadband range (parameter 5550) and the configured delay expand deadband time (parameter 5554) expires, the deadband will be multiplied with the factor configured here.</p> <p>Notes</p> <p>This parameter is only visible if frequency control (parameter 5507) is configured to "3pos controller".</p>
5554	Delay expand deadband	1	1.0 to 9.9 s [2.0 s]	<p>The measured generator frequency must be within the deadband range for the time configured here in order to multiply the deadband with the factor configured in parameter 5553.</p> <p>Notes</p> <p>This parameter is only visible if frequency control (parameter 5507) is configured to "3pos controller".</p>

ID	Parameter	CL	Setting range [Default]	Description
				5507) is configured to "3pos controller".
5518	AM Frequency SP1[Hz]	2	Determined by AnalogManager 81.03 [A1 = 05.51 Internal f setp1 [Hz]]	<p>The Frequency setpoint 1 source may be selected from the available data sources.</p> <p>The internal frequency setpoint 05.51 can be changed manually at the setpoint screen of the display.</p> <p>Notes</p> <p>The frequency setpoint may be adjusted within the configured operating limits (↳ "4.5.1.1 Generator Operating Ranges: Voltage / Frequency / Busbar").</p>
5500	Int. freq. control setpoint 1 (Internal frequency control setpoint 1)	2	15.00 to 85.00 Hz [50.00 Hz]	<p>The internal generator frequency setpoint 1 is defined in this screen.</p> <p>This value is the reference for the frequency controller when performing islanded and/or no-load operations.</p> <p>Generally 50 Hz or 60 Hz will be the values entered into this parameter. It is possible to enter a different value here.</p>
5519	AM Frequency SP2[Hz]	2	Determined by AnalogManager 81.04 [A1 = 05.52 Internal f setp2 [Hz]]	<p>The Frequency setpoint 2 source may be selected from the available data sources.</p> <p>The internal frequency setpoint 05.52 can be changed manually at the setpoint screen of the display.</p> <p>Notes</p> <p>The frequency setpoint may be adjusted within the configured operating limits (↳ "4.5.1.1 Generator Operating Ranges: Voltage / Frequency / Busbar").</p>
5501	Int. freq. control setpoint 2 (Internal frequency control setpoint 2)	2	15.00 to 85.00 Hz [50.00 Hz]	<p>The internal generator frequency setpoint 2 is defined in this screen.</p> <p>This value is the reference for the frequency controller when performing islanded and/or no-load operations.</p> <p>Generally 50 Hz or 60 Hz will be the values entered into this parameter. It is possible to enter a different value here.</p>
4554	Freq.filter time const.control	2	0.0 to 99.9 s [0.0 s]	<p>The PT1-filter for the actual Generator frequency value can be configured here. The parameter stands for the 3 times tau value of a PT1 element. That means the</p>

ID	Parameter	CL	Setting range [Default]	Description
				<p>configured time defines when 95% of the original value jump is reached. The filtered value is used as input to the controller.</p> <p>Notes</p> <p>The actual generator frequency which is used as filter source (L12, L1N or MPU), depends on ↩ 1851 and ↩ 5097.</p> <p>Input 0.0 s disables the filter influence.</p>
5502	Slip frequency setpoint offset	2	0.00 to 0.50 Hz [0.10 Hz]	<p>This value is the offset for the synchronization to the busbar/utility.</p> <p>With this offset, the unit synchronizes with a positive slip.</p> <p>Example</p> <p>If this parameter is configured to 0.10 Hz and the busbar/mains frequency is 50.00 Hz, the synchronization setpoint is 50.10 Hz.</p> <p>Notes</p> <p>The MCB can be synchronized with an individual slip frequency (also negative).</p> <p>The activation of MCB sync. with separate slip can be selected with parameter ↩ 5709 (HMI: configuration breakers MCB) hat comes with the MCB slip freq. setpoint offset parameter ↩ 5647 (HMI: configuration application controller frequency).</p>
5505	Phase matching gain	2	1 to 99 [5]	<p>The phase matching gain multiplies the setting of the proportional gain (parameter ↩ 5510) for phase matching control.</p>
5506	Phase matching df-start	2	0.02 to 0.25 Hz [0.05 Hz]	<p>Phase matching will only be enabled if the frequency difference between the systems to be synchronized is below the configured value.</p>
12918	Setpoint 2 freq. (Setpoint 2 frequency)	2	Determined by LogicsManager 86.81 [(0 & 1) & 1]	<p>If this LogicsManager condition is TRUE, the frequency setpoint 2 will be used instead of frequency setpoint 1. The frequency (result of AM) ↩ 5519 instead of ↩ 5518 will be taken into account.</p> <p>Notes</p> <p>For information on the LogicsManager and its default</p>

ID	Parameter	CL	Setting range [Default]	Description
				<p>settings see ↗ "9.3.1 LogicsManager Overview".</p> <p>Remotely switching the setpoint is possible: Use the LogicsManager command variable for input that is correlating with the dedicated bit of parameter ↗.</p>
5516	Start frequency control level	1	15.00 to 85.00 Hz [47.00 Hz]	<p>The frequency controller is activated when the monitored generator frequency has exceeded the value configured in this parameter.</p> <p>This prevents the easYgen from attempting to control the frequency while the engine is completing its start sequence.</p>
5517	Start frequency control delay	1	0 to 999 s [5 s]	The frequency controller is enabled after the configured time for this parameter expires.
5503	Freq. control setpoint ramp (Frequency control setpoint ramp)	2	0.10 to 60.00 Hz/s [2.50 Hz/s]	<p>The different setpoint values are supplied to the controller via this ramp.</p> <p>The slope of the ramp is used to alter the rate at which the controller modifies the setpoint value.</p> <p>The faster the change in the setpoint is to be carried out, the greater the value entered here must be.</p>
5504	Frequency control droop	2	0.0 to 20.0% [2.0%]	<p>If this control is to be operated on a generator in parallel with other generators and frequency control is enabled, a droop characteristic curve must be used.</p> <p>Notes</p> <p>Each generator in the system will require the same value to be configured for the droop characteristic, so that when the system is stable the active power will be distributed proportionally among all generators in relation to their rated power.</p>
12904	Freq. droop act. (Frequency droop active)	2	Determined by LogicsManager 86.25 [(08.17 Missing members OR 08.06 GCB fail to open) & 1]	<p>If this LogicsManager condition is TRUE, the frequency droop is enabled.</p> <p>Notes</p> <p>For information on the LogicsManager and its default settings see ↗ "9.3.1 LogicsManager Overview".</p> <p>The active droop will also be sent to an ECU connected to the J1939 interface (CAN interface 2). This</p>

4 Configuration

4.4.4.4 Frequency Control

ID	Parameter	CL	Setting range [Default]	Description
				<p>information is independent from the breaker states or active controller (frequency or power controller).</p> <p>Example</p> <ul style="list-style-type: none"> Rated power: 500 kW Rated frequency setpoint: 50.0 Hz Droop 5.0% Active power: 0 kW = 0% of rated power <p>Frequency is adjusted to: $(50.0 \text{ Hz} - [5.0\% * 0.0 * 50 \text{ Hz}]) = 50.0 \text{ Hz}$.</p> <ul style="list-style-type: none"> Active power: +250 kW = +50% of rated power <p>Frequency is adjusted to: $(50.0\text{Hz} - [5\% * 0.50 * 50 \text{ Hz}]) = 50.0 \text{ Hz} - 1.25 \text{ Hz} = 48.75 \text{ Hz}$.</p> <ul style="list-style-type: none"> Active power: +500 kW = +100% of rated power <p>Frequency is adjusted to: $(50.0\text{Hz} - [5\% * 1.00 * 50 \text{ Hz}]) = 50.0 \text{ Hz} - 2.5 \text{ Hz} = 47.50 \text{ Hz}$.</p>
12909	Release f-control	2	Determined by LogicsManager 86.96 [(1 & 1) & 1]	<p>This LogicsManager is used to activate generally the frequency biasing to the sub controller. If the LogicsManager is false the output will be on the initial state (see parameter 5508).</p> <p>The LogicsManager condition status 'TRUE' is activating the frequency or power regulation according to the LogicsManager 'F/P control' ID 12940.</p> <p>Notes</p> <p>For information on the LogicsManager and its default settings see 9.3.1 LogicsManager Overview.</p>

4.4.4.5 Load Control



A 2nd ramp is implemented to meet both BDEW and VDE AR-N 4105 decoupling requirements

Additionally to the »Load control setpoint ramp« parameter [↪ 5522](#) there is an alternative (2nd) »Load control ramp decoupling« parameter [↪ 5014](#) available for ramping slower. So it is possible to follow the BDEW/VDE requirements

- after mains decoupling
and
- after »Frequency depending derating of power« (see chapter [↪ "4.4.4.5.4 Derating And Uprating Of Power"](#)) becomes inactive.

Default ramping is backward compatible because parameter [↪ 5015](#) per default comes with zero.



NEW LogicsManager to disable all load ramps (BDEW)

With LogicsManager [↪ 12853](#) It is possible to activate the fastest load ramp e.g., for test.

4.4.4.5.1 Configure: Load Control (general)



ToolKit: find settings screen

Analog Managers to define input signal of load setpoint (1, 2, 3, 4) are available in ToolKit by

- a click from screen/page "Configure voltage control"
 - on the button "Analog manager" in the left sidebar (below permanent buttons)
or
 - on "next page", or
- search for one of the load controlled value shown at the status screen



ToolKit: Trend chart

ToolKit offers a trend visualization accessible by

- a click from screen/page "General load control"
 - on the button "Trend chart" in the left sidebar (below permanent buttons) or
 - on "next page", or
- search (for parameter)

4 Configuration

4.4.4.5.1 Configure: Load Control (general)

ID	Parameter	CL	Setting range [Default]	Description
5525	Load control	2	[PID analog]	The generator load is controlled using an analog PID controller.
			3pos controller	The generator load is controlled using a three-step controller.
			Off	Load control is not carried out.
5513	Proportional gain	2	0.01 to 100.00 [1.00]	<p>The proportional coefficient specifies the gain. By increasing the gain, the response is increased to permit larger corrections to the variable to be controlled.</p> <p>The farther out of tolerance the process is the larger the response action is to return the process to the tolerance band.</p> <p>Notes</p> <p>If the gain is configured too high, the result is excessive overshoot/undershoot of the desired value.</p> <p>This parameter is only visible if load control (parameter ↔ 5525) is configured to "PID analog".</p>
5514	Integral gain	2	0.00 to 100.00 [1.00]	<p>The integral gain identifies the I part of the PID controller.</p> <p>The integral gain corrects for any offset (between setpoint and process variable) automatically over time by shifting the proportioning band.</p> <p>Reset automatically changes the output requirements until the process variable and the setpoint are the same.</p> <p>This parameter permits the user to adjust how quickly the reset attempts to correct for any offset.</p> <p>Notes</p> <p>The integral gain constant must be greater than the derivative time constant. If the integral gain constant is too large, the engine will continually oscillate.</p> <p>If the integral gain steady is too small, the engine will take too long to settle at a steady state.</p> <p>This parameter is only visible if load control (parameter ↔ 5525) is configured to "PID analog".</p>
5515	Derivative ratio	2	0.01 to 100.00 [0.01]	<p>The derivative ratio identifies the D part of the PID controller.</p> <p>By increasing this parameter, the stability of the system is increased. The controller will</p>

ID	Parameter	CL	Setting range [Default]	Description
				<p>attempt to slow down the action of the actuator in an attempt to prevent excessive overshoot or undershoot. Essentially this is the brake for the process.</p> <p>This portion of the PID loop operates anywhere within the range of the process unlike reset.</p> <p>Notes</p> <p>This parameter is only visible if load control (parameter ↪ 5525) is configured to "PID analog".</p> <p>The default configured controller acts like a PI controller what is the valid D part setting for systems with secondary controllers.</p>
5560	Deadband	1	0.10 to 9.99% [1.00%]	<p>The generator load is controlled in such a manner, when paralleled with the mains, so that the monitored load does not deviate from the configured load setpoint by more than the value configured in this parameter without the controller issuing a raise/lower signal to the speed control.</p> <p>This prevents unneeded wear on the raise/lower relay contacts. The configured percentage for the dead band refers to the generator rated active power (parameter ↪ 1752).</p> <p>Notes</p> <p>This parameter is only visible if load control (parameter ↪ 5525) is configured to "3pos controller".</p>
5561	Time pulse minimum	1	0.01 to 2.00 s [0.05 s]	<p>A minimum pulse on time must be configured here.</p> <p>The shortest possible pulse time should be configured to limit overshoot of the desired speed reference point.</p> <p>Notes</p> <p>This parameter is only visible if load control (parameter ↪ 5525) is configured to "3pos controller".</p>
5562	Gain factor	1	0.1 to 10.0 [5.0]	<p>The gain factor K_p influences the operating time of the relays.</p> <p>By increasing the number configured in this parameter, the operating time of the relay will be increased in response to a deviation from the frequency reference.</p>

4 Configuration

4.4.4.5.1 Configure: Load Control (general)

ID	Parameter	CL	Setting range [Default]	Description
				<p>By increasing the gain, the response is increased to permit larger corrections to the variable to be controlled. The farther out of tolerance the process is the larger the response action is to return the process to the tolerance band.</p> <p>Notes</p> <p>If the gain is configured too high, the result is excessive overshoot/undershoot of the desired value.</p> <p>This parameter is only visible if load control (parameter ↩ 5525) is configured to "3pos controller".</p>
5637	Cycle time factor	1	1.0 to 20.0 [1.0]	<p>The cycle time factor adjusts the time between the pulses (pause time).</p> <p>By increasing the cycle time factor, the time between the pulses increases.</p> <p>Notes</p> <p>This parameter is only visible if voltage control (parameter ↩ 5525) is configured to "3pos controller".</p>
5563	Expand deadband factor	1	1.0 to 9.9 [1.0]	<p>If the measured generator load is within the deadband range (parameter ↩ 5560) and the configured delay expand deadband time (parameter ↩ 5564) expires, the deadband will be multiplied with the factor configured here.</p> <p>Notes</p> <p>This parameter is only visible if load control (parameter ↩ 5525) is configured to "3pos controller".</p>
5564	Delay expand deadband	1	1.0 to 9.9 s [2.0 s]	<p>The measured generator load must be within the deadband range for the time configured here in order to multiply the deadband with the factor configured in parameter ↩ 5563.</p> <p>Notes</p> <p>This parameter is only visible if load control (parameter ↩ 5525) is configured to "3pos controller".</p>
5522	Load control setpoint ramp 1	2	0.10 to 100.0%/s [3.00%/s]	<p>The different setpoint values are supplied to the controller via this ramp. The slope of the ramp is used to alter the rate at which the controller modifies the setpoint value. The faster the change in the setpoint is to be carried out,</p>

ID	Parameter	CL	Setting range [Default]	Description
				the greater the value entered here must be.
				<p>Notes</p> <p>This ramp is also used in islanded operation for loading or unloading an additional genset. An excessive oscillation may occur if the ramp is configured too high.</p>
5014	Load control setpoint ramp 2	2	0.01 to 100.0%/s [0.15%/s]	<p>The different setpoint values are supplied to the controller via this ramp. The slope of the ramp is used to alter the rate at which the controller modifies the setpoint value. The faster the change in the setpoint is to be carried out, the greater the value entered here must be.</p> <p>Notes</p> <p>This ramp is also used in islanded operation for loading or unloading an additional genset. An excessive oscillation may occur if the ramp is configured too high.</p>
11978	2nd load control setpoint ramp	2	Determined by LogicsManager 87.77 [(0 & 02.02) & 02.02]	<p>The LogicsManager can be used to switch from load ramp 1 to load ramp 2 settings.</p> <p>If this LogicsManager condition is TRUE and load ramp will be performed, »Load control setpoint ramp 2« will be used.</p>
5015	Time until decoupl. ramp reset	2	0 to 9999 s [0 s]	<p>The mains decoupling ramp (2nd load ramp) will be disabled after that time delay.</p> <p>Notes</p> <p>This parameter comes with default zero for backward compatibility (2nd load ramp disabled). BDEW prefers 600 s.</p>
5016	Load control setpoint ramp 3	2	0.10 to 100.00%/s [3.00%/s]	<p>The different setpoint values are supplied to the controller via this ramp. The slope of the ramp is used to alter the rate at which the controller modifies the setpoint value. The faster the change in the setpoint is to be carried out, the greater the value entered here must be.</p> <p>Notes</p> <p>This ramp is also used in islanded operation for loading or unloading an additional genset. An excessive oscillation may occur if the ramp is configured too high.</p>
11998	3rd load control setpoint ramp	2	Determined by LogicsManger 87.79	The LogicsManager can be used to switch from load ramp 1 or load

4 Configuration

4.4.4.5.1 Configure: Load Control (general)

ID	Parameter	CL	Setting range [Default]	Description
			[(02.02 & 02.02) & 02.02]	ramp 2 to load ramp 3 settings. If this LogicsManager condition is TRUE and load ramp will be performed, [Load control setpoint ramp 3] will be used. (3rd load control setpoint ramp has the highest priority.)
12853	Disable load setpoint ramp	2	Determined by LogicsManager 87.76 [(02.01& 1) & 1]	The LogicsManager can be used to perform fastest possible load ramp independent from load ramp settings. If this LogicsManager condition is TRUE and load ramp will be performed, e.g. a test with different setpoint steps but without any ramping is possible like requested by BDEW.
5569	Load control unloading ramp	2	0.10 to 100.00%/sec [3.00%/sec]	The ramp rate is used for the unloading in parallel operation or islanded operation.
5523	Load control setpoint maximum	2	0.0 to 150.0% [100.0%]	If the maximum generator load is to be limited, a percentage based on the rated generator power (parameter ↩ 1752) must be entered here. The controller adjusts the generator in such a manner that this value is not exceeded. This parameter limits the setpoint of the load controller when the generator is in a mains or island parallel operation.
3465	Min.generator power	1	0 to 100% [0%]	This is the minimum active power setpoint. Any lower other active power setpoint will be ignored! Notes For backward compatibility reasons the default value is zero. This min. value is also used for the AnalogManager data sources ↩ "9.4.2 Data Sources AM" <ul style="list-style-type: none"> • 05.19 Used P setp. [%] and <ul style="list-style-type: none"> • 05.20 Used P setp.ramp [%]
5524	Min.generator import/export	2	0 to 100% [0%]	If the minimum generator load is to be limited, a percentage based on the rated generator power (parameter ↩ 1752) must be entered here. The controller will not permit the load to drop below the configured load limit value. This parameter is only functional when the generator is in a mains parallel operation.
1886	Active power filter	2	0.0 to 99.9 s	The PT1-filter for the actual generator total active power value can be configured here. The

ID	Parameter	CL	Setting range [Default]	Description
			[0.0 s]	parameter stands for the 3 times tau value of a PT1 element. That means the configured time defines when 95% of the original value jump is reached. The filtered value is used as input to the controller. Notes Input 0.0 s disables the filter influence.
1882	Mains active power filter	2	0.0 to 99.9 s [0.0 s]	The PT1-filter for the actual mains total active power value can be configured here. The parameter stands for the 3 times tau value of a PT1 element. That means the configured time defines when 95% of the original value jump is reached. The filtered value is used as input to the controller. Notes Input 0.0 s disables the filter influence.
12940	P control	2	Determined by LogicsManager 86.98 [(04.07& 04.06) & 1]	The LogicsManager can be used to control whether frequency control or active power control should be performed. If this LogicsManager condition is TRUE, the active power control is performed.

4.4.4.5.2 Configure: Load Setpoints

**ToolKit: find settings screen**

Analog Managers to define input signal of load setpoint (1, 2, 3, 4) are available in ToolKit by

- a click from screen/page "Load setpoints"
 - on the button "Analog manager" in the left sidebar (below permanent buttons) or
 - on "next page", or
- search (for parameter)

ID	Parameter	CL	Setting range [Default]	Description
5526	Load setpoint 1	2	Import	The value entered for the import level shall always be supplied by the utility. All load swings are absorbed by the generator(s) provided the load rating for the generator(s) is not exceeded. The

4 Configuration

4.4.4.5.2 Configure: Load Setpoints

ID	Parameter	CL	Setting range [Default]	Description
				generator will always start when an import power operation is enabled.
			Export	The value entered for the export level shall always be supplied to the utility. All load swings are absorbed by the generator(s) provided the load rating for the generator(s) is not exceeded. The generator will always start when an export power operation is enabled.
			[Steady]	The generator shall always supply the value entered for the steady power level. All load swings are absorbed by the utility. The generator will always start when a steady power (base load) operation is enabled.
5520	Int. load control setpoint 1 (Internal load control setpoint 1)	2	0.0 to 99999.9 kW [100.0 kW]	The load setpoint 1 is defined in this screen. This value is the reference for the load controller when performing parallel operations.
5539	AM ActPower SP1 [kW]	2	Determined by AnalogManager 81.05 [A1 = 05.54 Internal P setp1 [kW]]	The load setpoint 1 source may be selected from the available data sources. The internal load setpoint 05.54 can be changed manually at the setpoint screen of the display.
				Notes The load setpoint may be adjusted between 0 and the configured load control setpoint maximum (parameter ↔ 5523).
5527	Load setpoint 2	2	Import	The value entered for the import level shall always be supplied by the utility. All load swings are absorbed by the generator(s) provided the load rating for the generator(s) is not exceeded. The generator will always start when an import power operation is enabled.
			Export	The value entered for the export level shall always be supplied to the utility. All load swings are absorbed by the generator(s) provided the load rating for the generator(s) is not exceeded. The generator will always start when an export power operation is enabled.
			[Steady]	The generator shall always supply the value entered for the steady power level. All load swings are absorbed by the utility. The generator will always start when a steady power (base load) operation is enabled.

ID	Parameter	CL	Setting range [Default]	Description
5521	Int. load control setpoint 2 (Internal load control setpoint 2)	2	0.0 to 99999.9 kW [200.0 kW]	The load setpoint 2 is defined in this screen. This value is the reference for the load controller when performing parallel operations.
5540	AM ActPower SP2 [kW]	2	Determined by AnalogManager 81.06 [A1 = 05.55 Internal P setp2 [kW]]	<p>The load setpoint 2 source may be selected from the available data sources.</p> <p>The internal load setpoint 05.55 can be changed manually at the setpoint screen of the display.</p> <p>Notes</p> <p>The load setpoint may be adjusted between 0 and the configured load control setpoint maximum (parameter ↩ 5523).</p>
12919	Setp. 2 load (Setpoint 2 load)	2	Determined by LogicsManager 86.82 [(0 & 1) & 1]	<p>If this LogicsManager condition is TRUE, the ActPower setpoint 2 will be used instead of ActPower setpoint 1. The ActPower (result of AM) ↩ 5540 instead of ↩ 5539 will be taken into account.</p> <p>Notes</p> <p>For information on the LogicsManager and its default settings see ↩ "9.3.1 LogicsManager Overview".</p> <p>Remotely switching the setpoint is possible: Use the LogicsManager command variable for input that is correlating with the dedicated bit of parameter ↩ R.</p>
5796	Load setpoint 3	2	Import	The value entered for the import level shall always be supplied by the utility. All load swings are absorbed by the generator(s) provided the load rating for the generator(s) is not exceeded. The generator will always start when an import power operation is enabled.
			Export	The value entered for the export level shall always be supplied to the utility. All load swings are absorbed by the generator(s) provided the load rating for the generator(s) is not exceeded. The generator will always start when an export power operation is enabled.
			[Steady]	The generator shall always supply the value entered for the steady power level. All load swings are absorbed by the utility. The generator will always start when a steady power (base load) operation is enabled.

4 Configuration

4.4.4.5.2 Configure: Load Setpoints

ID	Parameter	CL	Setting range [Default]	Description
5795	Int. load control setpoint 3 (Internal load control setpoint 2)	2	0.0 to 99999.9 kW [150.0 kW]	The load setpoint 3 is defined in this screen. This value is the reference for the load controller when performing parallel operations.
5606	AM ActPower SP3 [kW]	2	Determined by AnalogManager 81.07 [A1 = 05.80 Internal P setp3 [kW]]	<p>The load setpoint 3 source may be selected from the available data sources.</p> <p>The internal load setpoint 05.80 can be changed manually at the setpoint screen of the display.</p> <p>Notes</p> <p>The load setpoint may be adjusted between 0 and the configured load control setpoint maximum (parameter ↪ 5523).</p>
12998	Setp. 3 load (Setpoint 3 load)	2	Determined by LogicsManager 87.67 [(0 & 1) & 1]	<p>If this LogicsManager condition is TRUE and »Setp. 2 load« is not TRUE, the frequency setpoint 3 will be enabled., i.e. the setting of parameter ↪ 5606 overrides the setting of parameter ↪ 5539.</p> <p>If this LogicsManager condition is TRUE, the frequency setpoint 3 will be used instead of frequency setpoint 2. The ActPower SP3 (result of AM) ↪ 5606 instead of ↪ 5539 will be taken into account.</p> <p>Notes</p> <p>For information on the LogicsManager and its default settings see ↪ "9.3.1 LogicsManager Overview".</p> <p>Remotely switching the setpoint is possible: Use the LogicsManager command variable for input that is correlating with the dedicated bit of parameter ↪ ↻.</p>
5999	Load setpoint 4	2	Import	The value entered for the import level shall always be supplied by the utility. All load swings are absorbed by the generator(s) provided the load rating for the generator(s) is not exceeded. The generator will always start when an import power operation is enabled.
			Export	The value entered for the export level shall always be supplied to the utility. All load swings are absorbed by the generator(s) provided the load rating for the generator(s) is not exceeded. The generator will always start when an export power operation is enabled.

ID	Parameter	CL	Setting range [Default]	Description
			[Steady]	The generator shall always supply the value entered for the steady power level. All load swings are absorbed by the utility. The generator will always start when a steady power (base load) operation is enabled.
5998	Int. load control setpoint 4 (Internal load control setpoint 4)	2	0.0 to 99999.9 kW [50.0 kW]	The load setpoint 4 is defined in this screen. This value is the reference for the load controller when performing parallel operations.
5609	AM ActPower SP4 [kW]	2	Determined by AnalogManager 81.08 [A1 = 05.84 Internal P setp4 [kW]]	The load setpoint 4 source may be selected from the available data sources. The internal load setpoint 05.84 can be changed manually at the setpoint screen of the display. Notes The load setpoint may be adjusted between 0 and the configured load control setpoint maximum (parameter ↩ 5523).
12269	Setp. 4 load (Setpoint 4 load)	2	Determined by LogicsManager 87.75 [(0 & 1) & 1]	If this LogicsManager condition is TRUE and neither »Setp. 2 load« nor »Setp. 3 load« is true, the frequency setpoint 4 will be enabled, i.e. the setting of parameter ↩ 5609 overrides the setting of parameter ↩ 5539 . Notes For information on the LogicsManager and its default settings see ↩ "9.3.1 LogicsManager Overview" . Remotely switching the setpoint is possible: Use the LogicsManager command variable for input that is correlating with the dedicated bit of parameter ↩ 5539 .

4.4.4.5.3 Configure: Warm-up

ID	Parameter	CL	Setting range [Default]	Description
5532	Warm-up load limit	2	0 to 100% [15%]	The maximum load is limited to this percentage of the generator rated power (parameter ↩ 1752) until the warm-up time (parameter ↩ 5534) has expired or the warm-up temperature threshold (parameter ↩ 5546) has been exceeded.

ID	Parameter	CL	Setting range [Default]	Description
5534	Warm-up time	2	0 to 9999 s [0 s]	The maximum load is limited to the value configured in parameter ↩ 5532 for the time configured here.
				Notes This parameter is only effective if "Warm-up mode" (parameter ↩ 5533) is configured to "Time controlled".
5533	Warm-up mode	2	Analog val contr	The maximum load is limited to the value configured in parameter ↩ 5532 until the temperature measured according to the setting in parameter ↩ 5538 has exceeded the threshold configured in parameter ↩ 5546 .
			[Time controlled]	The maximum load is limited to the value configured in parameter ↩ 5532 until the time configured in parameter ↩ 5534 has expired.
5546	Warm-up threshold	2	0 to 1000 °C [80 °C]	The maximum load is limited to the value configured in parameter ↩ 5532 until the temperature has exceeded the threshold configured here.
				Notes This parameter is only effective if "Warm-up mode" (parameter ↩ 5533) is configured to "Analog val contr".
5538	AM Warm-up criterion	2	Determined by AnalogManager 81.02 [A1 = 10.01 ZERO]	The engine warm-up criterion may be selected from the available data sources. Notes This parameter is only effective if "Warm-up mode" (parameter ↩ 5533) is configured to "Analog val contr".

4.4.4.5.4 Derating And Uprating Of Power

General notes

The current active power setpoint can be derated to a defined value according to the application.

To ensure high flexibility the easYgen-XT offer the following derating functions:

- Direct derating

(Derating to the value of an analog manager. Refer to [↩ 6.3.18.1 Direct Derating](#).)

- Derating according to a characteristic curve

(Derating according to a configured e.g. temperature characteristic. Refer to [↪](#) “6.3.18.2 Derating With Characteristic Curve”.)

- J1939 (ECU) derating

(Derating driven by ECU to prevent knocking of the engine. Refer to [↪](#) “6.3.18.3 J1939 (ECU) Derating”.)

- Frequency depending derating

(Requirement of some grid codes. Refer to [↪](#) “4.4.4.5 Load Control”.)

Application fields

Derating examples:

- A fire pump is mechanically connected to an engine by a clutch. In this case the engine shall provide a limited amount of electrical power for the load sharing.
- An asynchronous load sharing is required. It is possible to operate an engine with limited power (e.g. if there is a new engine or after maintenance).

Uprating example:

- A single engine shall run with a higher load than the others e.g. for load test.

Block Diagram

This diagram shows the different paths of the selected derating sources:

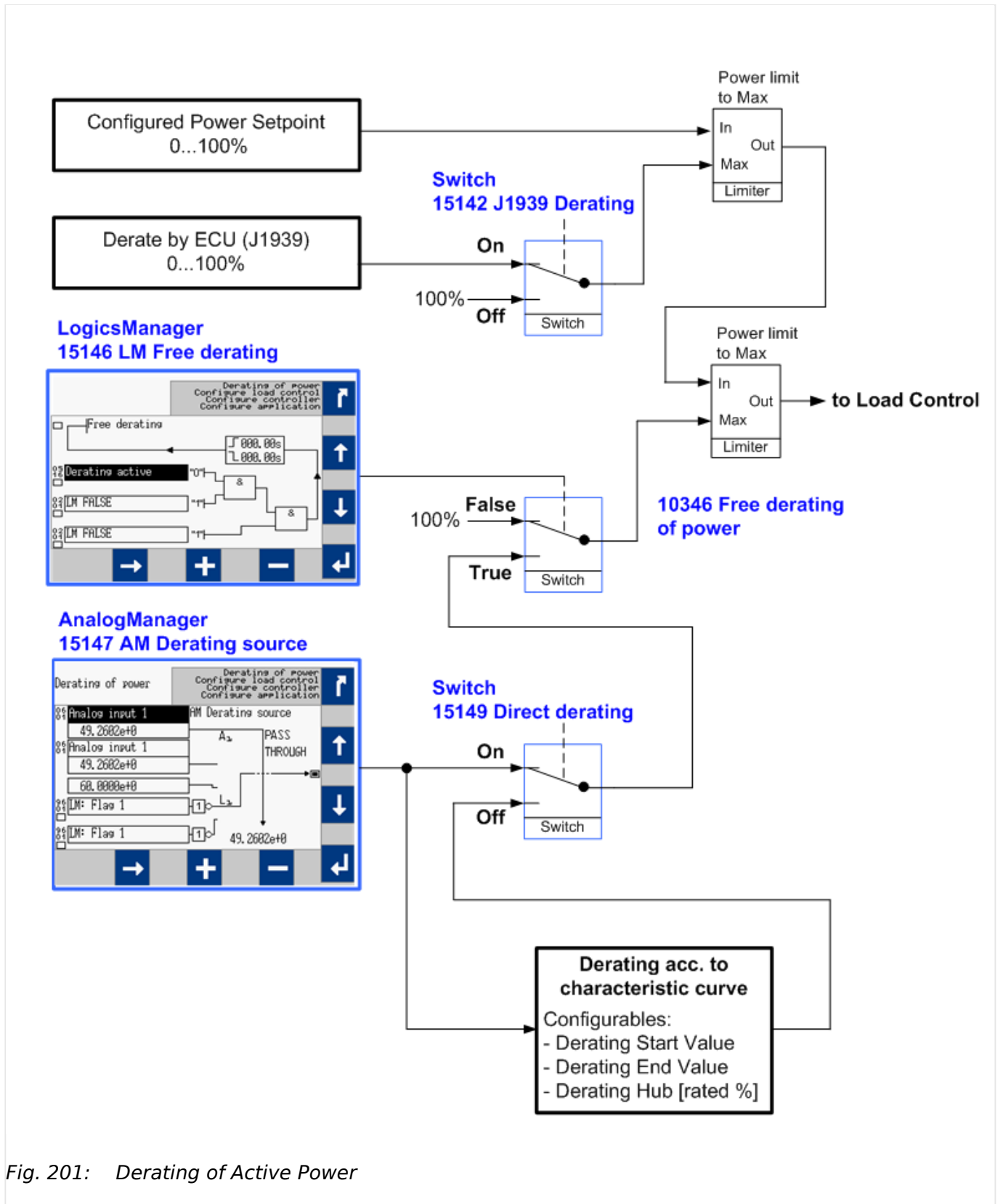

Fig. 201: Derating of Active Power



Derating priority

If more than one derating function is configured the one which calculates the lowest setpoint becomes effective.

Derating Parameters

ID	Parameter	CL	Setting range [Default]	Description
15149	Direct Derating	2	On	Only the analog source is used for the up-/derating. The parameters 15143, 15144, and 15145 are not visible neither in the HMI nor in ToolKit.
			[Off]	The free derating function uses the parameters 15143, 15144, and 15145 for the calculation from the derating value. This parameters are visible in the HMI and ToolKit.
15143	Start derating at	2	-032000 to 032000 [1000]	This parameter defines the starting point when the derating becomes active. The value applies to the analog source (parameter ↩ 15147). Value of the analog source which starts derating.
15144	Stop derating at	2	-032000 to 032000 [0]	This parameter defines (in combination with parameter ↩ 15143) the ramp of the derating function. Value of the analog source which ends derating.
15145	Max. power deviation	2	1.0 to 100.0% [100.0%]	This parameter defines the maximal power deviation of the derating function. That means it determines also the minimal power while derating is active. 100% minus this value is the lowest P value reachable by free derating. The configured percentage for the max. power deviation refers to the generator rated active power (parameter ↩ 1752).
15146	Free derating	2	Determined by LogicsManager 87.60 [(02.01 & 1) & 1]	This LogicsManager equation releases the free derating function.
15147	AM Derating source	2	Determined by AnalogManager 81.21 [A1 = 10.01 ZERO]	This parameter defines the analog source which controls the derating function.
15142 (see chapter below too)	J1939 derating	2		To prevent knocking in the engine, some ECUs (Engine Control Unit) transmit a J1939 CAN message to derate the power (in percentage of rated power). The easYgen is able to accept this message and to derate the power according to this message. If derating is active, the display shows the indication "Derating".

ID	Parameter	CL	Setting range [Default]	Description
			On	The derate command issued from the ECU via J1939 message is accepted.
			[Off]	The derate command via ECU is ignored.

Table 70: Parameters

Indication of derating

Where?	What?	Remarks
HMI	"Derating active"	ID 13281 (for protocols state indication)
	"Uprating active"	ID 13287 (for protocols state indication)
	Value of derating	The value is representing the derating in percent (not the resulting setpoint). For this reason this value becomes negative in case of uprating.
As LM command variable	05.16 for derating	If derating is active "Derating active" is shown in the status message and command variable 05.16 becomes active.
	05.17 for uprating	If uprating is active "Uprating active" is shown in the status message and command variable 05.17 becomes active.
Event list	entry	

The value of derating is shown in the following menus:

HMI: [Next Page / Setpoints / Derating]

ToolKit: [STATUS MENU / Setpoints / Derating]

In case of derating this value has positive in case of uprating has negative sign.

4.4.4.5.5 Active Power – Frequency Function P(f)

Introduction

The FNN VDE-AR-N 4105 / 4110 requests an active power control to stabilize the grid during mains faults. To maintain this the easYgen can be configured to:

- f depending derating of power OR
- f depending uprating of power OR
- both.

The reference for the uprating or derating power can be calculated out of the actual power or the rated power. This is differently treated in grid codes 4105 and 4110.

Function

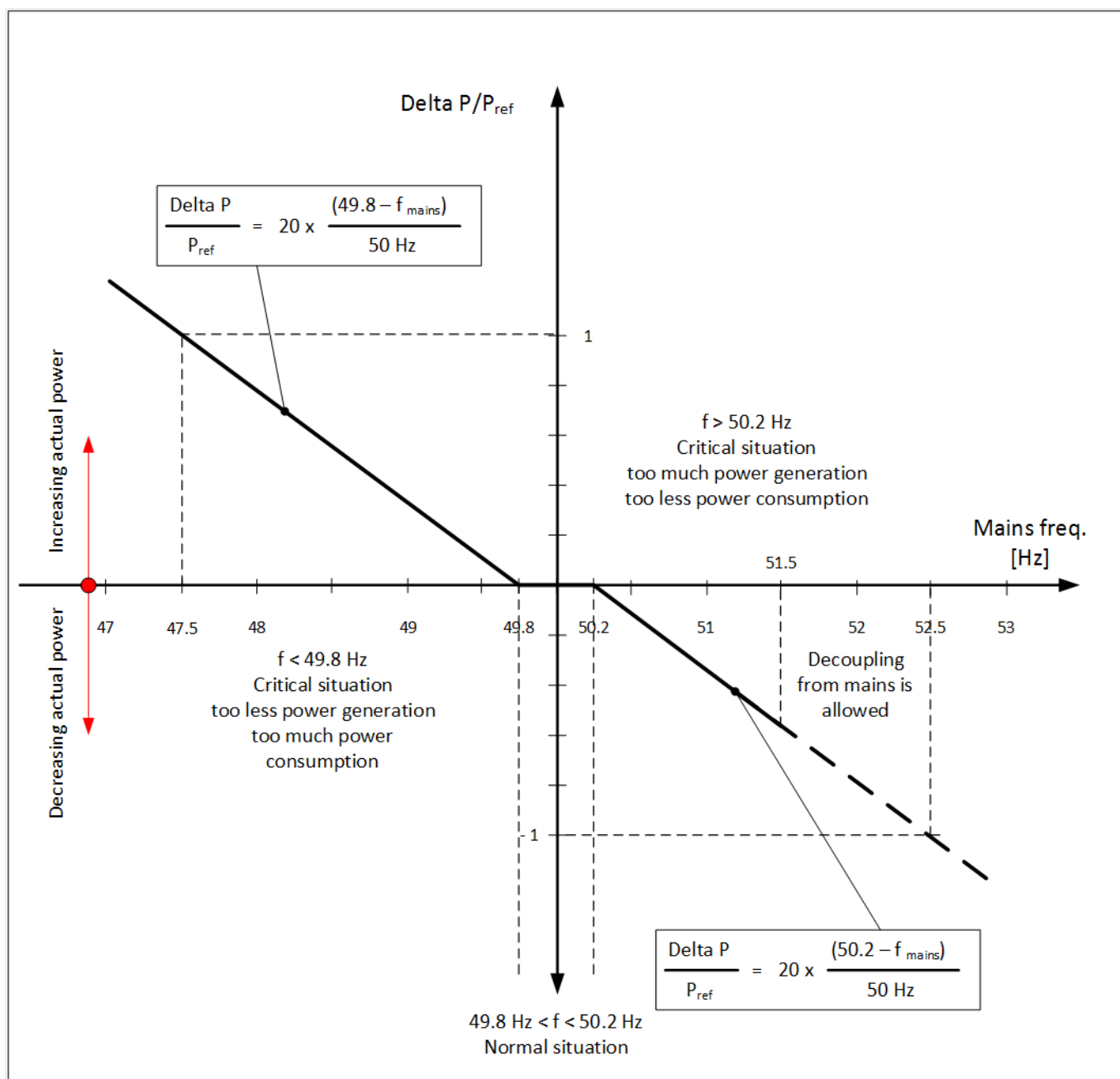

Fig. 202: De/Up-rating of active power setpoint due mains stabilization

Derating:

If the mains frequency exceeds the f start value ID 5782 the device calculates a power reduction in relation to the configured rate.

If the mains frequency exceeds the f stop value ID 5095 the calculation will be disabled and the active power controller regulates its original active power setpoint. Should the active power setpoint be changed meanwhile the mains failure power ramp will be activated.

Uprating

If the mains frequency underruns the f start value ID 5094 the device calculates a power increase in relation to the configured rate. If the mains frequency exceeds the f stop value ID 5095 the calculation will be disabled and the active power controller regulates its original active power setpoint. Should the active power setpoint be changed meanwhile the mains failure power ramp will be activated.

Frequency value for up/derating:

According to the VDE-AR-N 4110 a 200ms moving average mains frequency value is used. The frequency can be picked up under ID 236 or is usable via the AnalogManager variable "02.90 Mains freq.200ms [Hz]".

ID	Parameter	Setting range [Default]	Description
5807	Up/derating based on	Rated power [Actual power]	The reference for the active power derating/uprating is adjustable with this parameter. Rated power: In the moment of up/derating start the engine rated power is taken and from this value the percentage rating is calculated. Actual power: In the moment of up/derating start the actual power is stored and from this value the percentage rating is calculated.

Parameter Derating

ID	Parameter	Setting range [Default]	Description
5781	Function	On [Off]	The f depending derating of power can be enabled here. On: Active power derating is enabled. Off: Active power derating is disabled
5782	f start value	15.00 to 85.00 Hz [50.20 Hz]	If the mains frequency is higher than the start value the frequency depending derating function is enabled.
5783	f stop value	15.00 to 85.00 Hz [50.15 Hz]	The frequency depending derating function stops, if the mains frequency is lower than the stop value.
5784	f dep.derating	1 to 100 %/Hz [40 %/Hz]	Depending on the actual mains frequency, the generator active power decreases with the gradient value in relation to the active power the reference value.
5785	Hold max. derating	On [Off]	It can be determined, whether the max. calculated reduction value shall be hold. In that case the last highest reduction rate is kept until the the f-stop value is underrun.

ID	Parameter	Setting range [Default]	Description
			<p>Off: The reduction is executed along the reduction line.</p> <p>On: The reduction is executed and hold along the reduction line. With underrun the F stop value the reduction is reset.</p>

Parameter Uprating

ID	Parameter	Setting range [Default]	Description
5093	Function	On [Off]	<p>The f depending uprating of power can be enabled here.</p> <p>On: Active power uprating is enabled.</p> <p>Off: Active power uprating is disabled</p>
5094	f start value	15.00 to 85.00 Hz [49.80 Hz]	If the mains frequency is lower than the start value the frequency depending uprating function is enabled.
5095	f stop value	15.00 to 85.00 Hz [49.85 Hz]	The frequency depending uprating function stops, if the mains frequency is higher than the stop value.
5096	f dep.uprating	1 to 100 %/Hz [40 %/Hz]	Depending on the actual mains frequency, the generator active power increases with the gradient value in relation to the active power the reference value.

Configuration Test possibility for f dependent up/derating

For test purposes it is possible to configure a "Mains voltage test frequency" which is passed to the uprating and derating characteristics.

ID	Parameter	Setting range [Default]	Description
5808	Enable mains test frequency	On [Off]	<p>For test purposes it is possible to configure a "Mains voltage test frequency" which is passed to the uprating and derating characteristics.</p> <p>On:The mains test frequency is used for f- dependent up-/derating instead of the measured mains frequency.</p> <p>Off: The test frequency is disabled and the measured mains frequency is used.</p> <p>Note:Enable mains test frequency" is reset to Off automatically after 1 hour.</p>

ID	Parameter	Setting range [Default]	Description
5809	Mains test frequency	15.00 to 85.00 Hz [50.00 Hz]	If parameter 5808 is "On" this value is used for f- dependent up-/derating instead of measured mains frequency.

Start conditions

The power derating function becomes active, if the following conditions are true:

- Mains frequency > F_{Start} (parameter [↔ 5782](#)) AND
- Mains parallel operation active (MCB, GCB and if applicable GGB are closed) AND
- easYgen is in AUTOMATIC mode AND
- The corresponding controller functions are switched "On"

Stop conditions

The power derating function becomes inactive and will be reset, if at least one of the following conditions is true:

- Mains frequency < F_{Stop} (parameter [↔ 5783](#)) OR
- Mains parallel operation **not** active (MCB, GCB and if applicable GGB are open) OR
- easYgen is **not** in AUTOMATIC mode OR
- The corresponding controller functions are switched "Off"

AnalogManager sources:

These analog variables indicate the derating respectively uprating percent value:

- 05.28 P derating(f) [%] (same value as 10341)
- 05.48 P uprating(f) [%] (same value as 10357)

Visualization

Values which indicate the actual active power stored when the derating respectively uprating function has started:

- 4613 f dep.derating P reference [%]
- 10357 f dep.derating P reference [%]

Values which indicate the derating respectively uprating percent value:

- 10341 Freq.dep.derating of power [%]
- 10356 Freq.dep.uprating of power [%]

Values which indicate the resulting setpoint:

- 10358 Freq.dep.uprating of power [kW]

- 10359 Setpoint uprating of power [kW]

Examples Power Derating

If the frequency increases the value F_{Start} (Parameter \hookrightarrow 5782), the momentary power of the generator will be memorized by the controller as an **internal** value P_M . (P measured) and indicated at “4613 f dep. Derating P reference” [%]. Now, the power will be derated with a gradient R [%/Hz](parameter \hookrightarrow 5784).

All examples are using the following values:

- $P_{rated} = 200$ kW
- $P_M = 130$ kW
- $R = 40\%/Hz$ (parameter \hookrightarrow 5784)
- $F_{Start} = 50.20$ Hz (parameter \hookrightarrow 5782)
- $F_{Mains} = 50.50$ Hz

The power derating ΔP may be calculated using the following formulas:

- $\Delta P_{kW} = P_M$ [kW] $\times R$ [%/Hz] $\times (F_{Mains}$ [Hz] - F_{Start} [Hz]) / 100 [%]
- $\Delta P_{\%} = P_M$ [%] $\times R$ [%/Hz] $\times (F_{Mains}$ [Hz] - F_{Start} [Hz]) / 100 [%]

Example 1: Power derating with “5807 Up/derating based on” Actual power

- The power derating ΔP_{kW} is calculated as follows:
 - $\Delta P_{kW} = 130$ kW $\times 40$ %/Hz $\times (50.50$ Hz - 50.20 Hz) / 100% = 15.6 kW
 - “10358 Setpoint derating of power” indicates 114.4 kW (130 kW - 15.6 kW)
- The power derating $\Delta P_{\%}$ is calculated as follows:
 - $\Delta P_{\%} = 65$ % $\times 40$ %/Hz $\times (50.50$ Hz - 50.20 Hz) / 100% = **7.8 %**
 - “10341 Freq. dep. derating of power” and “05.28 P derating(f) [%]” indicates 7.8 %

The derating becomes inactive, if the frequency becomes lower than F_{Stop} (Parameter \hookrightarrow 5783)). (If the frequency becomes too high, the frequency monitoring function trips.)

Example 2: Power derating with “5807 Up/derating based on” Rated power

- The power derating ΔP may be calculated using the following formulas: The power derating ΔP_{kW} is calculated as follows:
 - $\Delta P_{kW} = 200$ kW $\times 40$ %/Hz $\times (50.50$ Hz - 50.20 Hz) / 100% = 24 kW
 - “10358 Setpoint derating of power” indicates 104 kW (130 kW - 24 kW).
- The power derating $\Delta P_{\%}$ is calculated as follows:
 - $\Delta P_{[\%]} = 100$ % $\times 40$ %/Hz $\times (50.50$ Hz - 50.20 Hz) / 100 % = **12 %**

- “10341 Freq. dep. derating of power” and “05.28 P derating(f) [%]” indicates 12 %

The derating becomes inactive, if the frequency becomes lower than F_{Stop} (Parameter [↪ 5783](#)). (If the frequency becomes too high, the frequency monitoring function trips.)

Example 3: Explanation of Parameter “5785 Hold max.derating”:

If the frequency decreases, while the derating is still active, the behavior depends on parameter “Hold max.derating” (parameter [↪ 5785](#))

The following assumptions are made:

- The corresponding parameters are set to default
- Derating has started with $F_{Start} = 50.20$ Hz with $P_M = 130$ kW
- The current frequency is 50.70 Hz → reduction $\Delta P = 26$ kW current power = 104 kW

Now the measured frequency decreases to 50.50 Hz:

- Hold max. derating” (parameter [↪ 5785](#)) = **Off**

The derating ΔP decreases to 15.6 kW according to the gradient 40 %/Hz the power is increasing to 114.4 kW.

- Hold max. derating” (parameter [↪ 5785](#)) = **On**

The derating still remains at 26 kW the power remains at 104 kW. During an active derating process, the power will never increase again. The power can only increase again if the derating becomes inactive, that means that the measured frequency has reached F_{Stop} .

4.4.4.6 PID {x} Control

General notes

The easYgen provides three additional freely configurable PID controllers. These controllers are intended and optimized for slow processes, like temperature control for heating systems (CHPO applications). The controller can either operate as a PID analog controller or a three-position controller.

ID	Parameter	CL	Setting range [Default]	Description
16338	Description	2	user-defined	This text will be displayed on the Setpoints screens. The text may have 1 through 16 characters.
16339			[PID controller {x}]	
16348				
5571	PID1 control	2	On	The PID controller is enabled.
5584			[Off]	No control is carried out.

ID	Parameter	CL	Setting range [Default]	Description
5670				
5580 5593 5679	PID1 ctrl.release	2	PID{x} Determined by LogicsManager 87.17, 87.18, 87.19 [(0 & 1) & 1] = 11406/11407/11408	If this LogicsManager condition is TRUE, the PID {x} controller will be released. Notes For information on the LogicsManager and its default settings see ↪ “9.3.1 LogicsManager Overview” .
5572 5585 5671	Proportional gain	2	0.001 to 65.000 [1.000]	The proportional coefficient specifies the gain. By increasing the gain, the response is increased to permit larger corrections to the variable to be controlled. The farther out of tolerance the process is the larger the response action is to return the process to the tolerance band. If the gain is configured too high, the result is excessive overshoot/undershoot of the desired value.
5573 5586 5672	Integral gain	2	0.010 to 10.000 [0.100]	The integral gain identifies the I part of the PID controller. The integral gain corrects for any offset (between setpoint and process variable) automatically over time by shifting the proportioning band. The integral gain automatically changes the output signal until the process variable and the setpoint are the same. The integral gain constant must be greater than the derivative time constant. If the integral gain constant is too large, the controlled value will continually oscillate. If the integral gain constant is too small, the controlled value will take too long to settle at a steady state.
5574 5587 5673	Derivative ratio	2	0.001 to 10.000 [0.001]	The derivative ratio identifies the D part of the PID controller. By increasing this parameter, the stability of the system is increased. The controller will attempt to slow down the action of the actuator in an attempt to prevent excessive overshoot or undershoot. Essentially this is the brake for the process.

4 Configuration

4.4.4.6 PID {x} Control

ID	Parameter	CL	Setting range [Default]	Description
5575 5588 5674	Time pulse minimum	1	0.01 to 2.00 s [0.05 s]	A minimum pulse on time must be configured here. The shortest possible pulse time should be configured, but the actuator should still react safe, to limit overshoot of the desired value reference point. (Only three-position controller)
5576 5589 5675	Deadband	1	0.00 to 32000.00 [10]	Shows the adjust range around the setpoint value when no displace impulse is issued. This avoids an unnecessary abrasion of relay contacts for higher/lower. (Only three-position controller)
5578 5591 5677	AM PID1 actual value	2	Determined by AnalogManager 81.14, 81.16, 81.18: [A1 = 10.01 ZERO]	The PID {x} control actual value may be selected from the available analog data sources. It is possible to select all data sources (↪ "9.4.2 Data Sources AM").
5577 5590 5676	AM PID1 setpoint	2	Determined by AnalogManager 81.13, 81.15, 81.17: [A1 = 05.75/76/77 Internal PID{x} setpoint]	The PID {x} control setpoint source may be selected from the available analog data sources. It is possible to select all data sources (↪ "9.4.2 Data Sources AM").
5579 5592 5678	Int. PID1 control setpoint	1	-32000 to 32000 [0]	The internal setpoint is defined in this screen. This value is the reference for the PID {x} controller.
5581 5594 5680	PID1 control initial state	2	0 to 100% [50%]	The value entered for this parameter is the start reference point for the analog output to the controller as long as the LogicsManager is false. If the PID controller has been disabled (e.g. Parameter ↪ 5571), the bias output will change to 0 %.
5582 5595 5681	Sampling time	2	0.08 to 360.00 s [1 s]	The sampling time is configured here. This is the time between two consecutive samples. The sampling time shall be configured high enough that the actual value can react in case e.g. a temperature just shifts slowly.
5692 5693 5694	Actuator run time	2	0.1 to 999.0 s [30.0 s]	The actuator run time is configured here. This is the time the actuator needs to move from fully closed to fully open. This information is necessary because the controller does not receive a feedback of the actuator position and needs this value to calculate the desired actuator position.
5734 5735 5736	PID1 control PI band	1	0 to 32000 [2000]	The PI band is configured here to encounter excessive overshoot of the process value when starting up. The PI band defines the range around the setpoint, in which the I portion of the PID controller is active.

ID	Parameter	CL	Setting range [Default]	Description
				If the actual value is outside of this band, the I portion is reduced to a minimum value. The PI band is not that important for three-position controllers and should be disabled by entering a high value (e.g. default value).
5737 5738 5739	PID1 control setpoint ramp	2	1 to 32000 [10]	<p>The different setpoint values are supplied to the controller via this ramp to prevent an overshoot of the process value when enabling the controller.</p> <p>The slope of the ramp is used to alter the rate at which the controller modifies the setpoint value. The faster the change in the setpoint is to be carried out, the greater the value entered here must be.</p>
7494 7495 7496	Unit	2	User-defined up to 6 characters text [_ _ _ _ _ _]	<p>This parameter is assigning a unit text to the displayed analog value.</p> <p>Notes</p> <p>This parameter may only be configured using ToolKit.</p> <p>The max. number of characters is 39 but depends on numbers of Bytes for each character. The Bytes/character are defined by the font of the currently selected language.</p> <p> Up to six characters are best for display/HMI; more will override screen border/frame. Please verify the length on the display for best view!</p>

4.4.4.7 Discrete Raise/Low Function

General notes

In operation modes MANUAL, TEST and AUTOMATIK the frequency / load and voltage / reactive power setpoints may be raised and lowered using the LogicsManager functionality, i.e. it is possible to use LogicsManager command variables to raise and lower these setpoints. In this case the discrete raise/lower function always starts with the rated value (frequency / load and voltage / reactive power).

Most commonly a button may be used to energize a discrete input on the control, which is used again as a LogicsManager command variable to enable the respective LogicsManager function to change the setpoint.

For related information refer to [↳ “4.1.5.9 Setpoints generator”](#).

Frequency and voltage may be adjusted within the configured operating limits ([↳ “4.5.1.1 Generator Operating Ranges: Voltage / Frequency / Busbar”](#)). Active power may be adjusted between 0 and the configured load control setpoint maximum

(parameter [↪ 5523](#)). The power factor may be adjusted between 0.71 leading and 0.71 lagging.

ID	Parameter	CL	Setting range [Default]	Description
12900	Discrete f/P +	2	Determined by LogicsManager 86.21 [(0 & 1) & 1]	Once the conditions of the LogicsManager have been fulfilled, the frequency / load setpoint will be raised.
			Notes For information on the LogicsManager and its default settings see ↪ "9.3.1 LogicsManager Overview" .	
12901	Discrete f/P -	2	Determined by LogicsManager 86.22 [(0 & 1) & 1]	Once the conditions of the LogicsManager have been fulfilled, the frequency / load setpoint will be lowered.
			Notes For information on the LogicsManager and its default settings see ↪ "9.3.1 LogicsManager Overview" .	
12902	Discrete V/PF +	2	Determined by LogicsManager 86.23 [(0 & 1) & 1]	Once the conditions of the LogicsManager have been fulfilled, the voltage / reactive power setpoint will be raised.
			Notes For information on the LogicsManager and its default settings see ↪ "9.3.1 LogicsManager Overview" .	
12903	Discrete V/PF -	2	Determined by LogicsManager 86.24 [(0 & 1) & 1]	Once the conditions of the LogicsManager have been fulfilled, the voltage / reactive power setpoint will be lowered.
			Notes For information on the LogicsManager and its default settings see ↪ "9.3.1 LogicsManager Overview" .	
5024	Discr. ramp frequency +/-	2	000.01 ... 100.00 %/s [000.07 %/s]	Configurable ramp rate for frequency setpoint raise and lower commands.
5025	Discr. ramp voltage +/-	2	000.01 ... 100.00 %/s [000.70 %/s]	Configurable ramp rate for voltage setpoint raise and lower commands.
5026	Discr. ramp power +/-	2	000.01 ... 100.00 %/s [003.00 %/s]	Configurable ramp rate for active power setpoint raise and lower commands.

ID	Parameter	CL	Setting range [Default]	Description
5027	Discr. ramp cos.phi +/-	2	000.01 ... 100.00 %/s [007.50 %/s]	Configurable ramp rate for Power Factor (PF) setpoint raise and lower commands.

4.4.4.8 Configure PV load reference

General notes

The easYgen offers a function to reduce the power output of photovoltaic inverter (PV Inverter). This could be important in cases where Gensets running side by side with PV inverter. Mainly in island applications where the consumer load can be so low that a fixed PV power drives the Gensets into reverse power. But even in cases where a minimal generator load output is underrun over longer time it is beneficial to reduce the PV power. To maintain this, the easYgen offers a PV load reduction respectively a PV load setpoint to send to the PV inverter.

The PV load references provides two different types to control the power output from the PV Inverter.

- Regulated
- Calculated

The PV load reference function contains a **monitor of generator reverse power**. It can be used e.g. to open the PV inverter breaker when the reverse power becomes critical. (Refer to [↳ “4.5.6.16 Monitoring PV load reference”](#)).

Parameter

Navigate to [Parameter / Configuration / Configure application / Configure controller / Miscellaneous / PV load reference].

ID	Parameter	CL	Setting range [Default]	Description
8911	PV load reference	2	[Off]	The function is disabled. The output value remains 0%.
			Regulated	The PV load reference function Regulated is enabled. If LogicsManager 8928 is true too, the PV function with the minimum load setpoint configured by AnalogManager 8914 becomes active. (Refer to ↳ “4.4.4.8.1 Photovoltaic (PV) load reduction regulated mode”)
			Calculated	The PV load reference function Calculated is enabled. If LogicsManager 8928 is true too, the PV function calculates the PV setpoint with the actual power values from the PV, the generator groups and the minimum generator power.

4 Configuration

4.4.4.8.1 Photovoltaic (PV) load reduction regulated mode

ID	Parameter	CL	Setting range [Default]	Description
				(Refer to 4.4.4.8.2 Photovoltaic (PV) load reduction calculated mode)
8928	Release PV regulation	2	Determined by LogicsManager 87.80 [(0 & 1) & 1]	<p>If this LogicsManager condition is TRUE and 8911 is Regulated or Calculated, the PV regulation becomes active.</p> <p>If this LogicsManager condition is FALSE and 8911 is Regulated, the regulation output 10.39 PV load ref. [%] goes on 100% and the load step "04.77 PV load ref. 100%" goes TRUE.</p> <p>If this LogicsManager condition is FALSE and 8911 is Calculated, the regulation output 10.99 PV power setp. [kW] goes on PV rated active power.</p>

4.4.4.8.1 Photovoltaic (PV) load reduction regulated mode

Function

With knowing the system load the easYgen3000XT regulates the PV power so that a given generator load level is kept.

The PV regulation output is PID control loop based on:

- The generator real load [%]
- The configurable generator minimal load [%] [8914](#)

To control the PV inverter, the easYgen3000XT calculates next:

- The AM variable 10.39 PV load ref. [%] (PV set-point value 0% - 100%, can be transferred to the PV inverter over an analog output)
- LM command variables (in applications using discrete load steps these LMs can be transferred to the PV inverter over several digital outputs):
 - 04.74 PV load ref. 0%
 - 04.75 PV load ref. 30%
 - 04.76 PV load ref. 60%
 - 04.77 PV load ref. 100%

In addition, the variable "10.39 PV load ref. [%]" (ID 9766) can be sent to the PV inverter via MODBUS TCP using the MODBUS MASTER ([6.5.5 Modbus master](#)) function of the easYgen3000XT. It is indicated also in ToolKit with a gauge.

The regulation output (analog or in steps) is treated as follows:

- If the Function is disabled (by parameter [8911](#)), the output "10.39 PV load ref. [%]" is 0%.

- If the Function is enabled and LM "Release PV regulation" (parameter [8928](#)) is FALSE, the output 10.39 PV load ref. [%] is 100% and 04.77 PV load ref. 100% is TRUE.
- If the Function is enabled and LM "Release PV regulation" (parameter [8928](#)) is TRUE, the output 10.39 PV load ref. [%] shows the current PID value and the corresponding LM "PV load ref." is TRUE.



To provide a proper function the PV reduction must be tracked slowly. Reverse power of the generator must lead to an instant cut of the PV load.

Overview PV load reduction regulated mode

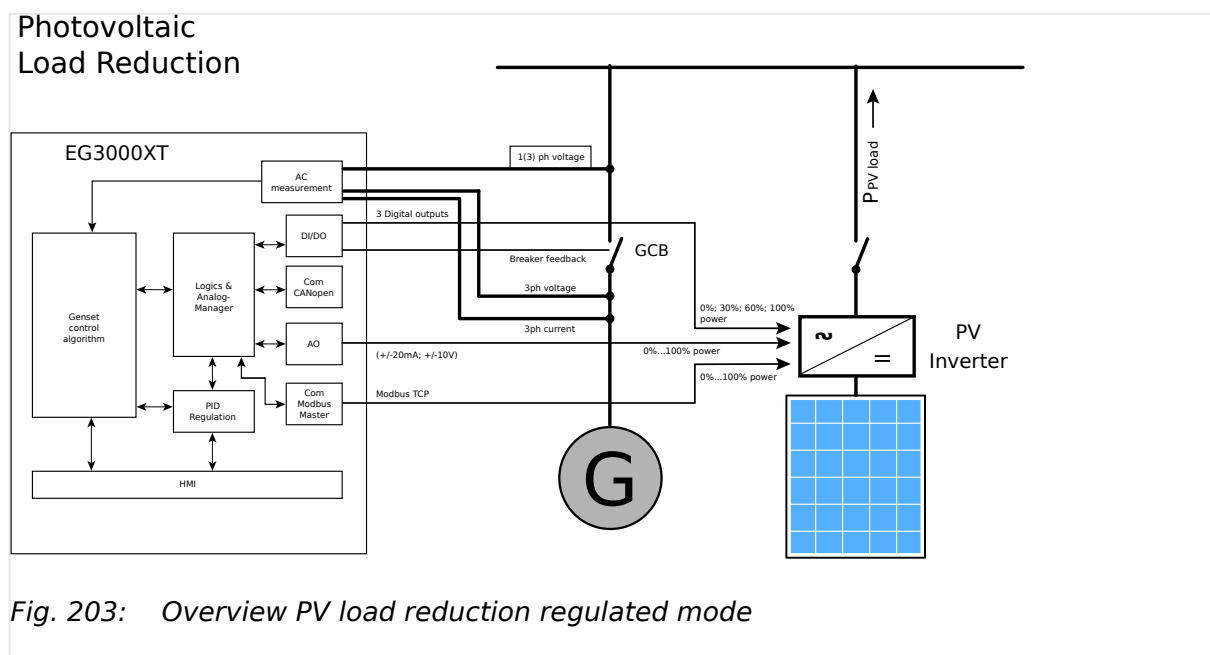

Fig. 203: Overview PV load reduction regulated mode

Parameter

ID	Parameter	CL	Setting range [Default]	Description
8917	Proportional gain	2	0.01 to 50.00 [5.00]	<p>The proportional coefficient specifies the gain. By increasing the gain, the response is increased to permit larger corrections to the variable to be controlled.</p> <p>The farther out of tolerance the process is the larger the response action is to return the process to the tolerance band.</p> <p>Notes</p> <p>If the gain is configured too high, the result is excessive overshoot/undershoot of the desired value.</p>
8918	Integral gain	2	0.01 to 10.00	<p>The integral gain identifies the I part of the PID controller.</p>

4 Configuration

4.4.4.8.1 Photovoltaic (PV) load reduction regulated mode

ID	Parameter	CL	Setting range [Default]	Description
			[1.00]	<p>The integral gain corrects for any offset (between setpoint and process variable) automatically over time by shifting the proportioning band.</p> <p>Reset automatically changes the output requirements until the process variable and the setpoint are the same.</p> <p>This parameter permits the user to adjust how quickly the reset attempts to correct for any offset.</p> <p>Notes</p> <p>The integral gain constant must be greater than the derivative time constant. If the integral gain constant is too large, the engine will continually oscillate.</p> <p>If the integral gain steady is too small, the engine will take too long to settle at a steady state.</p>
8919	Derivative ratio	2	0.01 to 10.00 [1.00]	<p>The derivative ratio identifies the D part of the PID controller.</p> <p>By increasing this parameter, the stability of the system is increased. The controller will attempt to slow down the action of the actuator in an attempt to prevent excessive overshoot or undershoot. Essentially this is the brake for the process.</p> <p>This portion of the PID loop operates anywhere within the range of the process unlike reset.</p>
8920	Sampling time	2	0.1 to 99.0 s [0.5 s]	<p>This is the time between two consecutive samples.</p>
8916	Deadband	2	0.0 to 30.0% [2.0%]	<p>The dead band function can be taken to minimize the interaction between genset control and PV inverter when a tolerance window is matched. The percentage entry is related on "8914 AM PV SP gen.min.load. The dead band function can be taken to minimize the interaction between genset control and PV inverter when a tolerance window is matched.</p> <p>Refer to the notes below the table for more information.</p>
8930	Setpoint ramp	1	0.1 to 10.0%/s [1.0%/s]	<p>This is the setpoint ramp for the actual generator minimal load if the regulation is enabled.</p>

ID	Parameter	CL	Setting range [Default]	Description
8921	Delay load increase step	1	0.1 to 999.0 s [10.0 s]	In applications using discrete load steps the next increasing step can be delayed here.
8922	Delay load decrease step	1	0.1 to 999.0 s [5.0 s]	In applications using discrete load steps the next decreasing step can be delayed here.
8912	PV Int.setpoint gen.min.load	1	1.0 to 100.0% [30.0%]	This is the generator load level which shall be preferably not underrun by PV power. The value configured here is available as analog variable "15.01 Int.SP gen.load [%]".
8914	AM PV SP gen.min.load	2	Determined by AnalogManager 81.34: [A1 = 15.01 Int.SP gen.load [%]]	With this AnalogManager the generator setpoint minimal load can be dynamically determined. It is related to the total active system power. Notes The analog output of the AnalogManager is internal limited between 0 and 150.

Notes

When using the digital PV load setpoint (0%, 30%, 60% and 100%), oscillation activation/deactivation may occur. A proper method to prevent this is to adjust the Deadband configuration. The calculation of the Deadband is often difficult to perform, so it is recommended to determine the value empirically:

- 1.) Begin with the default setting of the Deadband.
- 2.) Determine your desired PV set point generator minimal load.
- 3.) For better observing adjust ID 8921 "Delay load increase step" and ID8922 "Delay load decrease step" on 1 second.
- 4.) Put your PV Inverter into operation and check if the single steps (0%/30%/60%/100%) are switched correctly.
- 5.) If you have single- and multiple generator operation concentrate yourself on the single operation.
- 6.) Run the generator with a small load and observe the indication ID237 "Generator load".
- 7.) Increase the load now and observe the ID9766 "10.39 PV load ref. [%]". You will watch that the PV load reference will increase and match the first load reference point. With matching the reference point 30% for example the first step is switched. Observe on how much the generator load will be decreased and maybe increased (the oscillating begins) around the setpoint.
- 8.) Begin now to increase the Deadband until the oscillating is stopping.
- 9.) Continue that procedure with increasing the load and initiating the next load switches. Double check your dead band setting and accordingly increase it.

4 Configuration

4.4.4.8.2 Photovoltaic (PV) load reduction calculated mode

10.) Decrease now stepwise the load in the system and re-check on oscillating.

11.) If this setting works it should be automatically correct for the multiple generator operation.

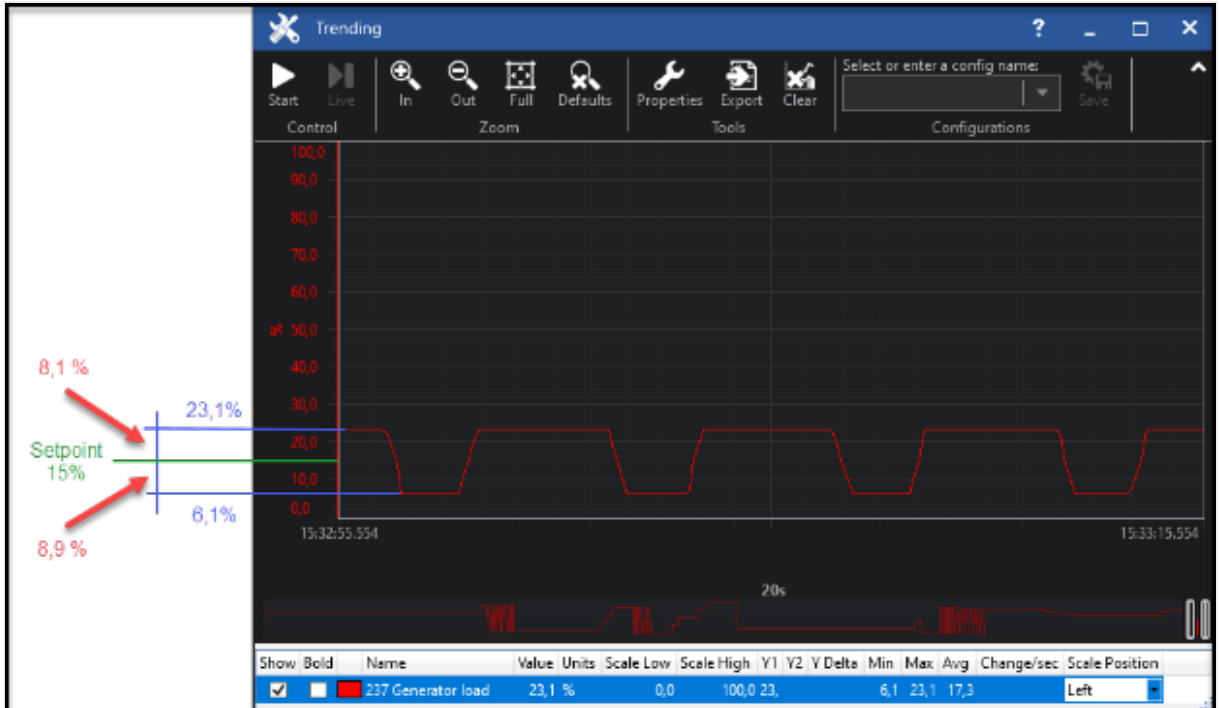

Fig. 204: The ToolKit trend shows the oscillating of a load step. The example shows that the dead band must be minimum $8.9\% + 1\% = 9.9\%$ that the oscillating is prevented.

4.4.4.8.2 Photovoltaic (PV) load reduction calculated mode

Function

With knowing the PV load and the load from generators the easYgen3000XT can calculate the active power setpoint from the PV penetration so that a given generator load level (minimum load) is kept.

The calculation algorithm is fed with:

- PV rated active power \hookrightarrow 8252
- PV actual active power \hookrightarrow 8255
- Gen.group1 active power \hookrightarrow 8260
- Gen.group2 active power \hookrightarrow 8265
- Gen.minimum power \hookrightarrow 8270

The PV Inverter setpoint is treated as follows:

- If the Function is disabled (by parameter \hookrightarrow 8911), the output "10.99 PV power setp. [kW]" is 0kW.
- If the Function is enabled and LM "Release PV regulation" (parameter \hookrightarrow 8928) is FALSE, the output 10.99 PV power setp. [kW] is the PV rated active power (100%).

- If the Function is enabled and LM "Release PV regulation" (parameter \hookrightarrow 8928) is TRUE, the output 10.99 PV power setp. [kW] shows the current calculated PV setpoint.

PV setpoint calculation

- **PV setpoint [kW] = Consumer load [kW] - Generator minimum power [kW]**
- Consumer load = PV power + Generator group 1 + Generator group 2

 The PV actual power, Generator group 1 actual power and Generator group 2 actual power is only added to the consumer load if the related breaker is closed.

Overview PV load reference calculated mode

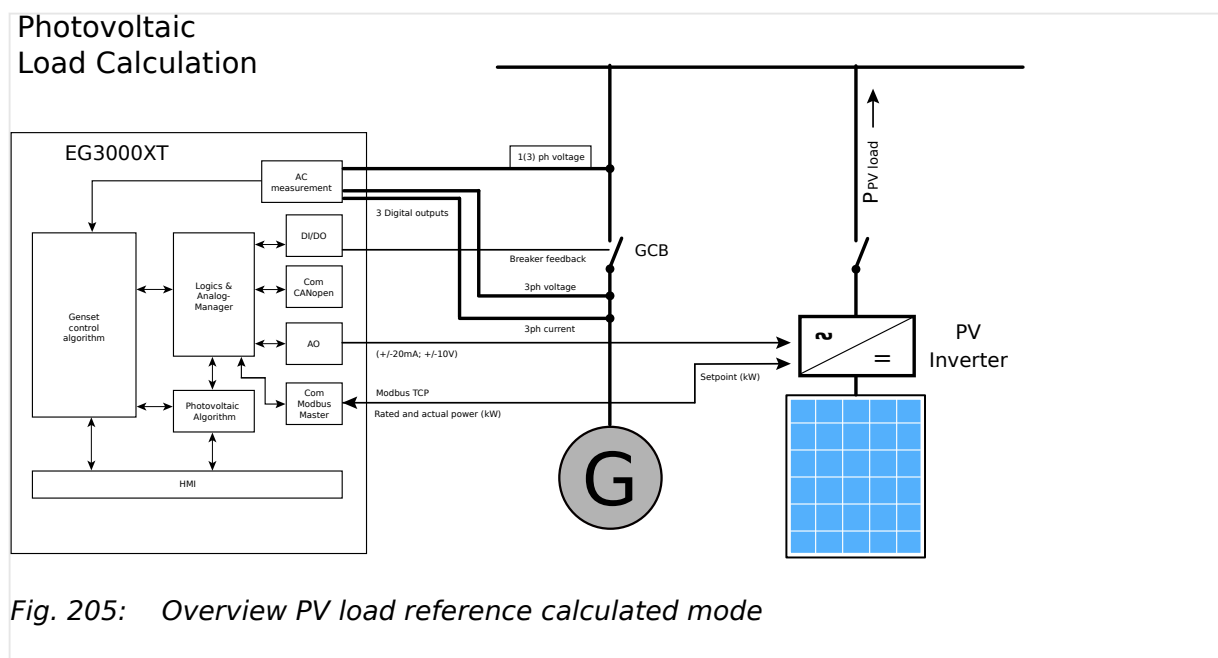

Fig. 205: Overview PV load reference calculated mode

Parameter

ID	Parameter	CL	Setting range [Default]	Description
8252	PV rated active power	2	Determined by AnalogManager 81.37: [A1 = 10.01 ZERO]	With this AnalogManager the PV rated active power can be dynamically determined. Notes The PV rated power is the maximum setpoint and the reference for the regulation output 10.49 PV power setp. [%].
8255	PV actual active power	2	Determined by AnalogManager 81.38: [A1 = 10.01 ZERO]	With this AnalogManager the PV actual active power can be determined. Notes The PV active power is only added to the consumer load if the PV

4 Configuration

4.4.4.8.2 Photovoltaic (PV) load reduction calculated mode

ID	Parameter	CL	Setting range [Default]	Description
				breaker is closed (LogicsManager ↩> 8258).
8258	PV breaker closed	2	Determined by LogicsManager 87.96 [(0 & 1) & 1]	If this LogicsManager condition is TRUE the PV active power is added to the consumer load calculation.
8260	Gen.group1 active power	2	Determined by AnalogManager 81.39: [A1 = 10.90 Generator load [kW]]	With this AnalogManager the generator group 1 actual active power can be determined. Notes The generator active power is only added to the consumer load if the generator group breaker is closed (LogicsManager ↩> 8263).
8263	Gen.group1 breaker closed	2	Determined by LogicsManager 87.97 [(04.87 Min. one GCB closed & 1) & 1]	If this LogicsManager condition is TRUE the Generator group 1 active power is added to the consumer load calculation.
8265	Gen.group2 active power	2	Determined by AnalogManager 81.40: [A1 = 10.01 ZERO]	With this AnalogManager the generator group 2 actual active power can be determined. Notes The generator active power is only added to the consumer load if the generator group breaker is closed (LogicsManager ↩> 8268).
8268	Gen.group2 breaker closed	2	Determined by LogicsManager 87.98 [(0 & 1) & 1]	If this LogicsManager condition is TRUE the Generator group 2 active power is added to the consumer load calculation.
8270	Gen.minimum power	2	Determined by AnalogManager 81.41: [C = 100]	With this AnalogManager the generator minimal active power can be dynamically determined. Notes Only if minimum one generator group breaker is closed the value is used for the PV setpoint calculation.
8276	PV setpoint ramp IOP	2	0.1 to 100.0%/s [10.0%/s]	This is the PV setpoint ramp for isolated operation (mains breaker is open).
8277	PV setpoint ramp MOP	2	0.1 to 100.0%/s [3.0%/s]	This is the PV setpoint ramp for mains parallel operation (mains breaker is closed).

4.4.5 Configure Operation Modes

4.4.5.1 Operation Modes: General



Priority of operation modes

The priority of operation modes is well defined from highest to lowest priority:

- »STOP« is higher than
- »AUTOMATIC« is higher than
- »MANUAL« is higher than
- »TEST«

ID	Parameter	CL	Setting range [Default]	Description
1795	Startup in mode (Operating mode after applying the power supply)	2		If the controller is powered down, the unit will start in the following configured mode when it is powered up again.
			[STOP]	The unit starts in the STOP operating mode.
			AUTO	The unit starts in the AUTOMATIC operating mode.
			MAN	The unit starts in the MANUAL operating mode.
			LLast	The unit starts in the last operating mode the control was in prior to being de-energized.
			TEST	The unit starts in the TEST operating mode.
				<p>Notes</p> <p>For the selection of the operating mode via the LogicsManager (if two different operating modes have been selected simultaneously) the control unit will prioritize the modes as follows:</p> <ul style="list-style-type: none"> • 1. STOP • 2. AUTOMATIC • 3. MANUAL • 4. TEST
12510	Operat. mode AUTO (Activate operating mode AUTOMATIC)	2	WARNING!	In Operation mode AUTO (intentionally):
				<ul style="list-style-type: none"> • the STOP button on front panel is without function and • the soft buttons for operation mode selection are not displayed.
				Notes

4 Configuration

4.4.5.1 Operation Modes: General

ID	Parameter	CL	Setting range [Default]	Description
				<p>If both Operation mode AUTO and 12120 Start req in AUTO are active the generator will start automatically with acknowledgment of the latest failure.</p>
			<p>Determined by LogicsManager 86.16</p> <p>[(0 & 1) & 1]</p> <p>= 10715</p>	<p>Once the conditions of the LogicsManager have been fulfilled the unit will change into operating mode AUTOMATIC.</p> <p>Notes</p> <p>For information on the LogicsManager and its default settings see 9.3.1 LogicsManager Overview.</p>
12520	<p>Operat. mode MAN</p> <p>(Activate operating mode MANUAL)</p>	2	<p>Determined by LogicsManager 86.17</p> <p>[(0 & 1) & 1]</p> <p>= 10716</p>	<p>Once the conditions of the LogicsManager have been fulfilled the unit will change into operating mode MANUAL.</p> <p>If MANUAL mode is selected via the LogicsManager it is not possible to change operating modes via the front panel.</p> <p>Notes</p> <p>For information on the LogicsManager and its default settings see 9.3.1 LogicsManager Overview.</p>
12530	<p>Operat. mode STOP</p> <p>(Activate operating mode STOP)</p>	2	<p>Determined by LogicsManager 86.18</p> <p>[(0 & 1) & 1]</p> <p>= 10717</p>	<p>Once the conditions of the LogicsManager have been fulfilled the unit will change into operating mode STOP.</p> <p>If STOP mode is selected via the LogicsManager it is not possible to change operating modes via the front panel.</p> <p>Notes</p> <p>For information on the LogicsManager and its default settings see 9.3.1 LogicsManager Overview.</p>
12271	<p>Operat. mode TEST</p> <p>(Activate operating mode TEST)</p>	2	<p>Determined by LogicsManager 86.29</p> <p>[(0 & 1) & 1]</p> <p>= 12272</p>	<p>Once the conditions of the LogicsManager have been fulfilled the unit will change into operating mode TEST.</p> <p>If TEST mode is selected via the LogicsManager it is not possible to change operating modes via the front panel.</p> <p>Notes</p> <p>For information on the LogicsManager and its default</p>

ID	Parameter	CL	Setting range [Default]	Description
				settings see ↗ "9.3.1 LogicsManager Overview".

4.4.5.2 Operation Mode AUTO - Automatic Run

General notes

The start of the engine can be performed via the following different logical conditions.

- A discrete input
- A temperature level
- An interface start condition
- A start request from the LDSS function
- A timer
- Any logical combination

If this logical output becomes TRUE in AUTOMATIC operating mode, the generator starts and the GCB will be closed. The simultaneous activation of other LogicsManager outputs (e.g. Stop req. in Auto) may affect this function.

The breaker handling depends on the configured application mode and breaker logic.



Refer to [↗](#) Fig. 206 and [↗](#) "9.3.4 Logical Outputs" for the priority of the logical outputs in case that more than one logical output is TRUE.

Engine start conditions

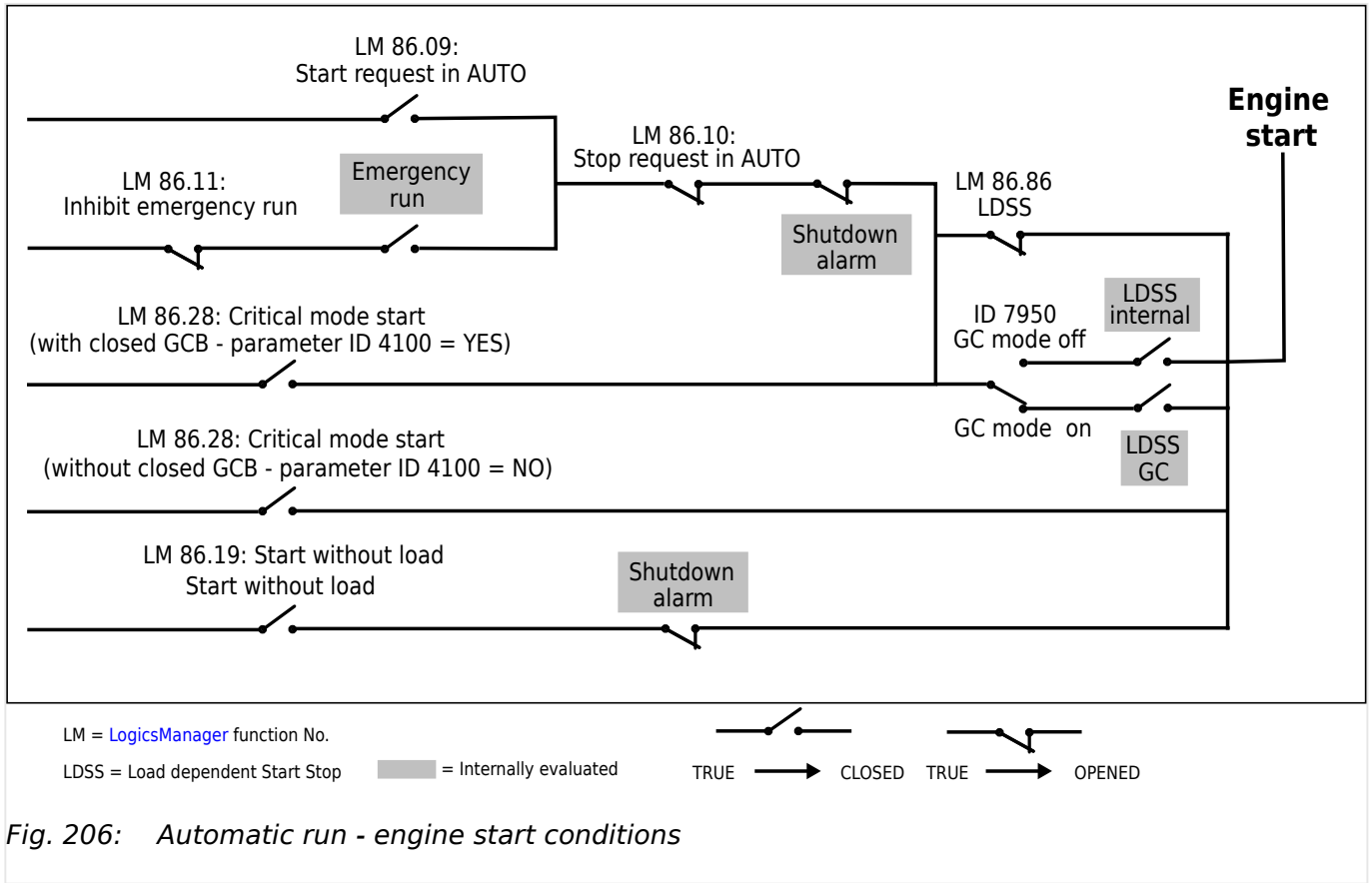

Fig. 206: Automatic run - engine start conditions

ID	Parameter	CL	Setting range [Default]	Description
12120	Start req. in AUTO (Start request in operation mode AUTOMATIC)	2	Determined by LogicsManager 86.09 [(09.02 Discrete input 2 OR 0) OR 04.13 Remote request] = 10708	Once the conditions of the LogicsManager have been fulfilled, the control issues a start request in AUTOMATIC mode. Notes For information on the LogicsManager and its default settings see "9.3.1 LogicsManager Overview" . ≥1: math. "OR"
12190	Stop req. in AUTO (Stop request in operation mode AUTOMATIC)	2	Determined by LogicsManager 86.10 [(0 & 1) & 1] = 10709	If this logical output becomes TRUE, it inhibits all other start processes (e.g. Start req. in Auto, emergency power, etc.). Stopping of the engine can be initiated externally via a discrete input or any logical combination. Once the conditions of the LogicsManager have been fulfilled, the control issues a stop request in AUTOMATIC mode. Notes It is possible to interrupt an already activated emergency run.

ID	Parameter	CL	Setting range [Default]	Description
				For information on the LogicsManager and its default settings see ↪ "9.3.1 LogicsManager Overview".
12540	Start w/o load (Start without assuming load)	2	Determined by LogicsManager 86.19 [(0 & 1) & 1] = 10718	<p>If this LogicsManager condition is TRUE switching from mains to generator supply following an engine start is prevented (the GCB close operation is blocked).</p> <p>This function may be used to perform a test operation. If an emergency power case occurs meanwhile, it is still possible to change to generator operation.</p> <p>If this condition becomes TRUE in islanded operation, the GCB cannot be opened before the MCB has been closed.</p> <p>Notes</p> <p>For information on the LogicsManager and its default settings see ↪ "9.3.1 LogicsManager Overview".</p>

4.4.5.3 Operation Mode TEST



Fig. 207: TEST button

Operation mode TEST gives the opportunity to test the genset. It can be activated via HMI button »TEST« or parameter 4672 »Test run mode«.



When the Test Run is time restricted:

- The remaining time is displayed on HMI.
- The device can change its operating mode after execution of the TEST mode.



In TEST mode the breakers are operated like in the application mode configured. The handling in the setpoint screen is be the same like in the AUTOMATIC mode.

Emergency run (AMF) and sprinkler run -- if configured -- both are fully supported.

4 Configuration

4.4.5.3 Operation Mode TEST

ID	Parameter	CL	Setting range [Default]	Description
4672	TEST run mode	2	[No load w/o time]	With enabling the operation mode TEST, the engine starts automatically. The GCB remains open.
			OFF	It is not possible to enable the operation mode TEST.
			No load w. time	With enabling the operation mode TEST, the engine starts automatically. The GCB remains open. After a configurable time (↪ 4679), the device switches to the operation mode configured with parameter ↪ 4680 »Operation mode after TEST«.
			Load w/o time	With enabling the operation mode TEST, the engine starts automatically. The GCB will be closed according to the configured »Breaker transition mode« (↪ 3411). If mains parallel operation is configured, the current active and reactive power setpoint is controlled.
			Load with time	With enabling the operation mode TEST, the engine starts automatically. The GCB will be closed according to the configured »Breaker transition mode« (↪ 3411). If mains parallel operation is configured, the current active and reactive power setpoint is controlled. After a configurable time (↪ 4679), the device switches to the operation mode configured with parameter ↪ 4680 »Operation mode after TEST«.
			Breaker access	With enabling the operation mode TEST, the engine starts automatically. From there on the breakers can be operated manually according to the configured „Breaker transition mode“ (↪ 3411). Notes In breaker transition mode “parallel” the MCB open and close commands are not supported.
4679	TEST mode time restriction	2	[60 s] 0..9999 s	This is the time duration for the time restricted TEST mode.
4680	Operation mode after TEST	2		This is the operation mode, on which the genset control changes after the time restricted TEST run.

ID	Parameter	CL	Setting range [Default]	Description
				After the TEST run ...
			[STOP]	... the genset control switches back to the STOP operation mode.
			Last	... the genset control switches back to the latest operation mode.
			MAN	... the genset control switches back to the MANUAL operation mode.
			AUTO	... the genset control switches back to the AUTOMATIC operation mode.

Control in TEST mode is application specific:

Breaker Transition Mode	Symbol	Available functionality in TEST mode
Parallel		<ul style="list-style-type: none"> The MCB is not active With the GCB button the load test can be started and interrupted If the GCB trips the load test is interrupted
Interchange		<ul style="list-style-type: none"> With the GCB button and the MCB button the load test can be started and interrupted The load transfer is similar to the AUTOMATIC mode If the GCB trips the load test is interrupted and the MCB will be closed if the condition matches: <ul style="list-style-type: none"> Release MCB Mains okay <p>(similar to the closing in AUTOMATIC mode)</p>
Closed Transit. / Open Transition		<ul style="list-style-type: none"> With the GCB button and the MCB button the load test can be started and interrupted If the GCB trips the load test is interrupted and the MCB will be closed if the condition matches: <ul style="list-style-type: none"> Release MCB Mains okay <p>(similar to the closing in AUTOMATIC mode)</p>
External		<ul style="list-style-type: none"> The MCB button isn't active With the GCB button the load test can be started and interrupted Only the GCB open logic is active similar to AUTOMATIC mode If the GCB trips the load test is interrupted

4.4.5.4 Critical Mode

The critical mode may be used to operate a fire engine pump or any other critical operation which does not allow a shutdown of the genset under any alarm conditions.

The LogicsManager is used to define the conditions that will enable the critical mode like a discrete input (for conditions and explanation of programming refer to [“9.3.1 LogicsManager Overview”](#)).

Alarm classes

When critical mode is enabled the alarm classes are reclassified as follows:

	Alarm classes					
Normal operation	A	B	C	D	E	F
Critical mode	A	B	B	B	B	B

During the postrun time all shutdown alarms become active again.

Critical mode "On"

A critical mode will be initiated/started once the critical mode operation LogicsManager output becomes TRUE (logic "1"). The "Critical mode" message is displayed on the display screen. If the engine is not already running, the controller will attempt to start the engine as configured (parameter [4102](#)). All shutdown alarms become warning messages (see above).

Critical mode "Off"

A critical mode will be interrupted/stopped once critical mode operation LogicsManager output becomes FALSE (logic "0") and the postrun time has expired. During the postrun time all shutdown alarms become active again.

If the operation mode changes to STOP, the postrun time will still be performed.



Refer to [“9.3.4 Logical Outputs”](#) for more information about the priorities of the logical outputs.

4.4.5.4.1 Critical Operation At Busbar

The fire engine pump mentioned before or other critical operation is connected to the busbar, i.e. it requires a closed GCB to be supplied by the generator during critical operation.

Parameter [4100](#) (Close GCB in critical mode) should be configured to "Yes" and an external provision for load reduction should be provided. This ensures the pump operation of a sprinkler system.



Application and breaker transition mode remain as configured.
A mains parallel operation is possible.

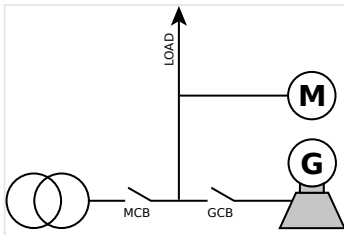

Fig. 208: Critical operation at busbar



The GCB will not be closed if the load is supplied by the mains until the mains fail and the MCB remains closed because emergency run (parameter [↩> 2802](#)) is disabled.

Critical mode during mains supply

If critical mode is enabled during mains supply (MCB is closed), the generator will be started (if not already running) and the GCB will be closed.

- The "Critical mode" message is displayed on the display screen. All shutdown alarms become warning messages.
- If critical mode is disabled again, all shutdown alarms become active again.

If the genset was not running before critical mode has been enabled, it will be stopped after the critical mode postrun time (parameter [↩> 4102](#)) has expired. MCB operation will be performed according to the configured transition mode.

Emergency power during critical mode

If there is a mains failure during critical mode, the "Emerg/Critical" message is displayed on the display screen after the mains fail delay time (parameter [↩> 2800](#)) has expired.

All shutdown alarms become warning messages.

- Critical mode ends before mains recovery:
 - The emergency power operation will be continued and all shutdown alarms become active again.
 - If the mains returns, the unit transfers the load from generator supply to mains supply after the mains settling delay expires.
- Emergency power operation ends before the end of the critical mode:
 - The critical mode is maintained and the load is transferred from generator supply to mains supply after the mains settling delay expires.
 - If open transition mode is configured, the GCB will not be opened to prevent a dead busbar.
 - The engine remains running until the conditions for the critical mode are no longer existent.
 - If the genset was not running before critical mode has been enabled, it will be stopped after cool down time (parameter [↩> 3316](#)) has expired.

- The GCB will take the same state as it had before the critical mode has been enabled.

Critical mode during emergency power

An emergency power operation is active (load is supplied by the generator, GCB is closed, MCB is open). If critical mode is enabled now, the GCB remains closed and the "Emerg/Critical" message is displayed on the display screen. All shutdown alarms become warning messages.

- Critical mode ends before mains recovery:
 - The emergency power operation will be continued and all shutdown alarms become active again.
 - If the mains return, the unit transfers the load from generator supply to mains supply after the mains settling delay expires, if Enable MCB (parameter [↔ 12923](#)) has been enabled.
- Emergency power operation ends before the end of the critical mode:
 - The critical mode is maintained and the load is transferred from generator supply to mains supply after the mains settling delay expires.
 - The engine remains running until the conditions for the critical mode are no longer existent.
 - If the genset was not running before critical mode has been enabled, it will be stopped after cool down time (parameter [↔ 3316](#)) has expired.
 - The GCB will take the same state as it had before the critical mode has been enabled.

Start request during critical mode

The critical mode operation has a higher priority than the remote request (Start/Stop request in AUTO). Therefore, the remote request cannot start or stop the engine and has no effect on the breaker positions. The "Critical mode" message is displayed on the display screen and all shutdown alarms become warning alarms.

- Critical mode ends before the start request is terminated:
 - The engine continues running. All shutdown alarms will become active again.
 - By resetting the start request the GCB will be opened and the engine will be stopped.
- Start request will be terminated before the critical mode is terminated:
 - The critical mode operation is continued.
 - The engine keeps running until the conditions for the critical mode are no longer fulfilled and all shutdown alarms will become active again.
 - If the genset was not running before critical mode has been enabled, it will be stopped after cool down time (parameter [↔ 3316](#)) has expired.
 - The GCB will take the same state as it had before the critical mode has been enabled.

4.4.5.4.2 Critical Operation At The Generator

The fire engine pump mentioned before or other critical operation is connected to the generator, i.e. it does not require a closed GCB to be supplied by the generator during critical operation.

Parameter  4100 (Close GCB in critical mode) should be configured to "No". This ensures an open GCB during critical mode. A closed GCB is possible in case of an emergency operation.

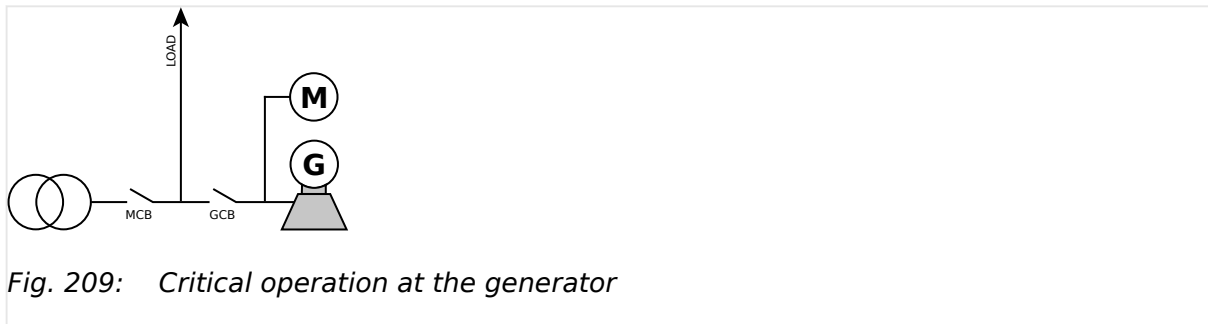





Fig. 209: Critical operation at the generator

Critical mode during mains supply

If critical mode is enabled during mains supply (MCB is closed), the generator will be started (if not already running) and operated with open GCB. The "Critical mode" message is displayed on the display screen. All shutdown alarms become warning messages.

If critical mode is disabled again, all shutdown alarms become active again. If the genset was not running before critical mode has been enabled, it will be stopped after the critical mode postrun time (parameter  4102) has expired.

Emergency power during critical mode

If there is a mains failure during critical mode, the MCB will be opened after the mains fail delay time (parameter  2800) has expired and the GCB will be closed. It is not necessary to configure parameter  4101 (Break emerg. in critical mode) because the critical operation is already supplied. The "Emerg/Critical" message is displayed on the display screen and all shutdown alarms become warning messages.

- Critical mode ends before mains recovery:
 - The emergency power operation will be continued and all shutdown alarms become active again.
 - If the mains returns, the unit transfers the load from generator supply to mains supply after the mains settling delay expires.
- Emergency power operation ends before the end of the critical mode:
 - The critical mode is maintained and the load is transferred from generator supply to mains supply after the mains settling delay expires.
 - The GCB will be opened without unloading (transition mode interchange or parallel).
 - All shutdown alarms become active again.
 - If the genset was not running before critical mode has been enabled, it will be stopped after cool down time (parameter  3316) has expired.

Critical mode during emergency power

An emergency power operation is active (load is supplied by the generator, GCB is closed, MCB is open). If critical mode is enabled now, the GCB will be opened dependent on the setting of the parameter [↩> 4101](#) (Break emerg. in critical mode) and a closure of the GCB is prevented for this time. The "Emerg/Critical" message is displayed on the display screen and all shutdown alarms become warning messages.

- Critical mode ends before mains recovery:
 - The emergency power operation will be continued and all shutdown alarms become active again.
 - If the mains return, the unit transfers the load from generator supply to mains supply after the mains settling delay expires.
- Emergency power operation ends before the end of the critical mode:
 - The critical mode is maintained and the load is transferred from generator supply to mains supply after the mains settling delay expires.
 - The GCB will be opened without unloading (transition mode interchange or parallel).
 - All shutdown alarms become active again.
 - If the genset was not running before critical mode has been enabled, it will be stopped after cool down time (parameter [↩> 3316](#)) has expired.

Start request during critical mode

The critical mode operation has a higher priority than the remote request (Start/Stop request in AUTO). Therefore, the remote request cannot start or stop the engine and has no effect on the breaker positions. The "Critical mode" message is displayed on the display screen and all shutdown alarms become warning alarms.

- Critical mode ends before the start request is terminated:
 - The engine continues running and a change to generator or parallel operation is performed.
 - All shutdown alarms will become active again.
- Start request will be terminated before the critical mode is terminated:
 - The critical mode operation is continued. The engine keeps running until the conditions for the critical mode are no longer fulfilled and all shutdown alarms will become active again.
 - If the genset was not running before critical mode has been enabled, it will be stopped after cool down time (parameter [↩> 3316](#)) has expired.
 - The GCB will take on the same state as it has before the critical mode has been enabled.

Critical mode during start request

The generator supplies the load and the GCB is closed. If critical mode is enabled, the MCB will be operated according to the configured transition mode (parameter [↩> 3411](#)). The GCB will be opened without unloading (transition mode interchange or parallel). The

"Critical mode" message is displayed on the display screen and all shutdown alarms become warning alarms.

- Critical mode ends before the start request is terminated:
 - The engine continues running and a change to generator or parallel operation is performed.
 - All shutdown alarms will become active again.
- Start request will be terminated before the critical mode is terminated:
 - The critical mode operation is continued.
 - The engine keeps running until the conditions for the critical mode are no longer fulfilled and all shutdown alarms will become active again.
 - If the genset was not running before critical mode has been enabled, it will be stopped after cool down time (parameter [↩ 3316](#)) has expired.

Critical mode during islanded operation

The busbar is supplied by the generator and emergency run (parameter [↩ 2802](#)) is disabled. If the critical mode is enabled, the GCB will be opened although the MCB is not enabled. This will cause a dead busbar.

4.4.5.4.3 Parameters

ID	Parameter	CL	Setting range [Default]	Description
12220	Critical mode	2	Determined by LogicsManager 86.28 [(0 & !05.08 Start fail) & ! 09.01 Discrete input 1] = 11607	If this logical output becomes TRUE in AUTOMATIC operating mode, it starts the critical mode. Notes For information on the LogicsManager and its default settings see ↩ "9.3.1 LogicsManager Overview" .
4109	Critical mode postrun	2	0 to 6000 s [600 s]	The critical mode operation is continued for the time configured here after the critical mode request has been terminated. The message "Cool down" is displayed and the LogicsManager command variable 04.10 becomes TRUE.
4100	Close GCB in critical mode	2	Yes	If a critical mode operation is detected the GCB will close.
			[No]	The GCB cannot be closed during a critical mode operation.
			Notes	This parameter only applies to application mode A03 to A12 .
4105	Critical mode alarm class MAN	2	Yes	The critical mode alarm classes will override the normal operation

ID	Parameter	CL	Setting range [Default]	Description
	(Critical mode alarm classes active in MANUAL operating mode)			alarm classes when in MANUAL operation mode so alarm classes become restricted to WARNING level - NO engine shut down. LogicsManager output ↪ 12220 becomes TRUE.
			[No]	The alarm classes will not be changed in the MANUAL operating mode e.g. engine shut down is possible!

4.4.5.5 Load Dependent Start/Stop (LDSS)

General notes

Load-dependent start/stop may either be performed according to a system reserve power or the generator load depending on the configuration of the "Start stop mode" (parameter [↪ 5752](#)).



In the application mode "GCB/GC" **A1B** the LDSS algorithm is in the Group Controller. For this reason the functionality differs and in the easYgen only the following LDSS parameters are visible and valid in this mode: (Other configuration must be done in the Group Controller. Refer to GC manual.)

- LD start stop (parameter [↪ 12930](#))
- Base priority (parameter [↪ 5751](#))
- Minimum running time (parameter [↪ 5759](#))
- LDSS transtion time (parameter [↪ 5805](#))
- LDSS Priority 2 (parameter [↪ 12926](#))
- LDSS Priority 3 (parameter [↪ 12925](#))
- LDSS Priority 4 (parameter [↪ 12924](#))



Refer to [↪ "9.6.2 Load Dependent Start Stop \(LDSS\) Formulas"](#) for all formulas related to the LDSS function.

4.4.5.5.1 Generator Load

If the "Start stop mode" (parameter [↪ 5752](#)) is configured to »Generator load«, load-dependent start stop is performed in a way that the next genset will be started if all gensets in operation reach the maximum generator load (parameter [↪ 5762](#) or [↪ 5770](#) "IOP/MOP Max. generator load"), a configured percentage (e.g. 80%) of the rated power. In order to stop one generator, the load of all gensets in operation must fall below the minimum generator load (parameter [↪ 5763](#) or [↪ 5771](#) "IOP/MOP Min. generator load"), a configured percentage (e.g. 30%) of the rated power. There are different setpoints for islanded and mains parallel operation.

The LDSS algorithm acting on »Generator load« offers different dynamic levels:

- With higher dynamic the efficiency can be increased, but the change of generators becomes more frequent.
- With lower dynamic the efficiency can be lower for the first couple of engines, but overall the change of generators becomes less frequent.

Three levels of Dynamic

High:

- After removing of generator rated power the new generator load level shall not lay higher than 75% within the Add-on / Add-off band.

Moderate:

- After removing of generator rated power the new generator load level shall not lay over 50% within the Add-on / Add-off band.

Low:

- After removing of generator rated power the new generator load level shall not lay over 25% within the Add-on / Add-off band

An additional dynamic parameter (parameter [↩ 5757](#) or [↩ 5758](#) "IOP/MOP Dynamic") with levels "Low", Moderate", and "Strong" prevents the gensets from being started and stopped continuously if only a few gensets are in operation.

This function provides an easy calculation for the start of the next genset.



- Refer to the description of the dynamic parameters for detailed information.

The following parameters need to configured for this operation:

Parameter ID	Parameter text	Note
5757	IOP Dynamic	only for islanded operation
5758	MOP Dynamic	only for mains parallel operation
5767	MOP Minimum load	only for mains parallel operation
5769	MOP Hysteresis	only for mains parallel operation
5770	MOP Max. generator load	only for mains parallel operation

Table 71: Load-dependent start/stop - parameters for generator load operation

Islanded operation (IOP)

If the configured maximum generator capacity utilization is exceeded, another genset will be added.

- $P_{GN_{real\ active}} > P_{max.\ load\ islanded}$

If the configured minimum generator capacity utilization has been fallen below, a genset will be stopped depending on the dynamic setting (parameter [↩ 5757](#)).

- $P_{GN_{real\ active}} < P_{min.\ load\ islanded}$

Mains parallel operation (MOP)

If the required generator load setpoint for the control at the mains interchange point exceeds the MOP minimum load threshold (parameter [↩➤ 5767](#)), the first genset will be added.

- $PMN_{\text{setpoint}} - PMN_{\text{real}} > PMOP_{\text{minimum}}$

If at least one genset is supplying the load in parallel with the mains and the total generator load exceeds the MOP maximum generator load threshold (parameter [↩➤ 5770](#)), another genset will be added.

- $PGN_{\text{real active}} > P_{\text{max. load parallel}}$

If at least two gensets are supplying the load in parallel with the mains and the configured minimum generator capacity utilization has been fallen below, a genset will be stopped depending on the dynamic setting (parameter [↩➤ 5758](#))

- $PGN_{\text{real active}} < P_{\text{min. load parallel}}$

If one genset is supplying the load in parallel with the mains and the generator load exceeds the MOP minimum load threshold (parameter [↩➤ 5767](#)) minus the hysteresis (parameter [↩➤ 5769](#)), the genset will be stopped.

The hysteresis is intended to prevent frequent starting and stopping of gensets in case of small load variations.

- $PMN_{\text{setpoint}} - PMN_{\text{real}} + PGN_{\text{real active}} < PMOP_{\text{minimum}} - P_{\text{hysteresis MOP}}$

4.4.5.5.2 System Reserve Power

If the "Start stop mode" (parameter [↩➤ 5752](#)) is configured to "Reserve power", load-dependent start stop is performed in a way that a configured minimum reserve power is maintained in the system. This means that there is always enough reserve power for load swings on the busbar regardless of the generator load. The actual reserve power in the system is the total rated power of all gensets on the busbar minus the actual total generator real power.

This functionality provides high system reliability and is intended for applications that require a dedicated reserve power on the busbar, independent of the number of gensets on the busbar.

The following parameters need to be configured for this operation:

Parameter ID	Parameter text	Note
5760	IOP Reserve power	only for islanded operation
5761	IOP Hysteresis	only for islanded operation
5767	MOP Minimum load	only for mains parallel operation
5768	MOP Reserve power	only for mains parallel operation
5769	MOP Hysteresis	only for mains parallel operation

Table 72: Load-dependent start/stop - parameters for reserve power operation



Note:

It is also possible to change the effective reserve power via interface. Refer to:

- “Remote LDSS IOP reserve power ”
- “Remote LDSS MOP reserve power ”

Islanded operation (IOP)

- $P_{Reserve} = P_{rated\ active} - P_{GN\ real\ active}$
- $P_{rated\ active} = P_{RatedGen[1]} + P_{RatedGen [2]} + \dots + P_{RatedGen [n]}$
(total rated power of all gensets on the busbar in the system)
- $P_{GN\ real\ active} = P_{ActualGen [1]} + P_{ActualGen [2]} + \dots + P_{ActualGen [n]}$
(total actual load of all gensets on the busbar in the system)

If the reserve power falls below the IOP Reserve power threshold (parameter 5760), another genset will be added.

- $P_{Reserve} < P_{Reserve\ IOP}$

If the reserve power exceeds the IOP Reserve power threshold (parameter 5760) plus the hysteresis (parameter 5761) plus the rated load of the genset, the genset will be stopped.

The hysteresis is intended to prevent frequent starting and stopping of gensets in case of small load variations.

- $P_{reserve} > P_{reserve\ islanded\ IOP} + P_{hysteresis\ IOP} + P_{RatedGen}$

Mains parallel operation (MOP)

- $P_{reserve} = P_{rated\ active} - P_{GN\ real\ active}$
- $P_{rated\ active} = P_{RatedGen [1]} + P_{RatedGen [2]} + \dots + P_{RatedGen [n]}$
(total rated power of all gensets on the busbar in the system)
- $P_{GN\ real\ active} = P_{ActualGen [1]} + P_{ActualGen [2]} + \dots + P_{ActualGen [n]}$
(total actual load of all gensets on the busbar in the system)

If the required generator load setpoint for the control at the mains interchange point exceeds the MOP minimum load threshold (parameter 5767), the first genset will be added.

- $P_{MN\ setpoint} - P_{MN\ real} > P_{MOP\ minimum}$

If at least one genset is supplying the load in parallel with the mains and the reserve power falls below the reserve power threshold (parameter 5768), another genset will be added.

- $P_{reserve} < P_{reserve\ parallel}$

If at least two gensets are supplying the load in parallel with the mains and the reserve power exceeds the MOP Reserve power threshold (parameter [↩ 5768](#)) plus the hysteresis (parameter [↩ 5769](#)) plus the rated load of the genset, the genset will be stopped.

The hysteresis is intended to prevent frequent starting and stopping of gensets in case of small load variations.

- $P_{\text{reserve}} > P_{\text{reserve parallel}} + P_{\text{hysteresis MOP}} + P_{\text{RatedGen}}$

If one genset is supplying the load in parallel with the mains and the generator load exceeds the MOP minimum load threshold (parameter [↩ 5767](#)) minus the hysteresis (parameter [↩ 5769](#)), the genset will be stopped.

The hysteresis is intended to prevent frequent starting and stopping of gensets in case of small load variations.

- $P_{\text{MN setpoint}} - P_{\text{MN real}} + P_{\text{GN real active}} < P_{\text{MOP minimum}} - P_{\text{hysteresis MOP}}$

4.4.5.5.3 Generator Selection

General notes

If a genset is to be started, the genset with the highest priority configured will be started. If a genset is to be stopped, the genset with the lowest priority configured will be stopped.

If all gensets have the same priority, the next genset is selected according to the size of engine, i.e. the genset combination, which allows an optimum efficiency will be used.

If all gensets have the same rated load or this parameter is disabled, the remaining hours until the next maintenance are considered. If these are also the same, the genset with the lowest generator number will be started first or stopped last.

Priority order:

- 1. Priority (parameter [↩ 5751](#))
- 2. Efficiency (size of engines) (parameter [↩ 5754](#))
- 3. Service hours (parameter [↩ 5755](#))
- 4. Generator (device) number (parameter [↩ 1702](#))

The load-dependent start/stop function requires the following conditions have been met:

- The control has been placed in AUTOMATIC operating mode
- A start request (Start req. in AUTO, Emergency run) is active
- All LDSS parameters are configured identically for all members at the load share line ([↩ "4.5.6.17 Multi-Unit Parameter Alignment"](#))
- The mains interchange load control (import/export power) has been enabled or the gensets are in islanded operation
- The conditions of the LogicsManager function "Load-dependent start/stop" have been fulfilled

ID	Parameter	CL	Setting range [Default]	Description
12930	LD start stop (Load-dependent start stop)	2	Determined by LogicsManager 86.86 [(0 & 1) & 1] = 11915	Once the conditions of the LogicsManager have been fulfilled, the load-dependent start/stop function is enabled. Notes For information on the LogicsManager and its default settings see ↪ "9.3.1 LogicsManager Overview" .
5752	Start stop mode	2	[Reserve power]	Load-dependent start stop is performed in a way that a configured minimum reserve power is maintained in the system. The reserve power is the total generator rated power minus the total actual generator power. If the reserve power falls below the threshold, another genset will be started. If the reserve power is sufficient to stop one genset without falling below the threshold, a genset will be stopped.
			Generator load	Load-dependent start stop is performed in a way that a configured maximum generator capacity utilization is not exceeded. If the generator capacity utilization exceeds this threshold, another genset will be started. If the generator capacity utilization is low enough to stop one genset without exceeding the threshold again, a genset will be stopped.
5753	Dead busbar start mode	2	[All]	All available gensets will be started in case of a dead busbar and remain connected to the busbar for the minimum running time (parameter ↪ 5759). Then the gensets will be stopped according to the configured LDSS procedure. The start delay is configured in parameter ↪ 2800 (Mains fail delay time).
			LDSS	The start of the gensets will be performed according to the configured LDSS priority in case of a dead busbar.
				Notes This function cannot be used as an emergency power function in mains parallel operations because it cannot control the MCB operation. If the MCB should be operated, the emergency run function

ID	Parameter	CL	Setting range [Default]	Description
				(parameter ↪ 2802) must be enabled.
5751	Base priority	2	1 to 32 1 to 248 in GCB/GC A13 mode [5]	<p>The priority of the genset in the load-dependent start/stop network is configured with this parameter (↪ “4.4.5.5.3 Generator Selection”). The lower the number configured here, the higher the priority.</p> <p>This priority may be overridden by the LDSS Priority parameters (parameters ↪ 12924, ↪ 12925, and ↪ 12926).</p>
5805	LDSS transition time	2	0 to 32000 s [180 s]	<p>This parameter is only valid in GCB/GC A13 mode.</p> <p>If the the GC has removed the start command, the easYgen holds its start command for this time supposed its GCB is already closed.</p>
12926	LDSS Priority 2	2	Determined by LogicsManager 86.90 [(0 & 1) & 1] = 111919	<p>Once the conditions of the LogicsManager have been fulfilled, the load-dependent start/stop priority will be set to 2 (the highest priority is valid).</p> <p>Notes</p> <p>For information on the LogicsManager and its default settings see ↪ “9.3.1 LogicsManager Overview”.</p>
12925	LDSS Priority 3	2	Determined by LogicsManager 86.91 [(0 & 1) & 1] = 11920	<p>Once the conditions of the LogicsManager have been fulfilled, the load-dependent start/stop priority will be set to 3 (the highest priority is valid).</p> <p>Notes</p> <p>For information on the LogicsManager and its default settings see ↪ “9.3.1 LogicsManager Overview”.</p>
12924	LDSS Priority 4	2	Determined by LogicsManager 86.92 [(0 & 1) & 1] = 11921	<p>Once the conditions of the LogicsManager have been fulfilled, the load-dependent start/stop priority will be set to 4 (the highest priority is valid).</p> <p>Notes</p> <p>For information on the LogicsManager and its default settings see ↪ “9.3.1 LogicsManager Overview”.</p>
5754	Fit size of engine	2		This parameter defines whether the start/stop priority order (↪ “4.4.5.5.3 Generator Selection”) considers the size of the engine (generator rated power) or not. In

ID	Parameter	CL	Setting range [Default]	Description
				<p>case of different sized gensets, the control can start a genset combination which results in optimum efficiency.</p> <p>The fuel efficiency may be optimized when this parameter is enabled. This parameter may be disabled if all generators have the same size.</p> <p>Notes</p> <p>The algorithm prefers one large engine instead of multiple small engines, even if this does not match the best possible efficiency.</p> <p>If an engine selection yields a condition, in which multiple small engines with its rated power cover exactly the rated power of an possible bigger engine, the bigger engine is preferred</p>
			Yes	The priority order considers the engine size for the start of the next engine for gensets with the same priority.
			[No]	The priority order does not consider the rated power of the engines to fit the best size of engines.
5755	Fit service hours	2		With this parameter the LDSS function can be configured to start and stop redundant engines according to their engine running hours with different methods.
			[Off]	The engine running hours are not considered when evaluating the engines to be started for gensets with same priority. The parameter 5756 »Changes of engines« has no influence and can be ignored.
			Staggered	<p>The remaining <i>hours until the next service is required</i> are considered when evaluating the engines to be started for gensets with same priority. The gensets are utilized in a way that the maintenance may be performed at different times to ensure that not all gensets have a downtime due to a maintenance at the same time. The genset with the lowest hours until the next service will be started first.</p> <p>Notes</p> <p>To run this functionality properly the maintenance call must be acknowledged accordingly.</p>
			Equal	The remaining <i>hours until the next service is required</i> are considered

ID	Parameter	CL	Setting range [Default]	Description
				<p>when evaluating the engines to be started for gensets with same priority. The gensets are utilized in a way that the maintenance may be performed at the same time for all gensets. The genset with the highest hours until the next service will be started first.</p> <p>Notes</p> <p>To run this functionality properly the maintenance call must be acknowledged accordingly.</p>
			Period of use	<p>The »period of use hours« (value of ID 2580) are considered when evaluating the engines to be started for gensets with same priority. The gensets are utilized in a way that the period of use hours are equalized over time for all participating gensets. The genset with the lowest period of use hours will be started first.</p>
5756	Changes of engines	2		<p>Load dependent start stop: Changes of engine</p> <p>With setting "Off" no time slot is considered and the change of engine is related directly on the passed engine hours. With a configured time slot (32/64/128 h) a minimum of passed engine running hours is taken into account before changing the gensets.</p> <p>If LDSS is configured to act on best possible equal maintenance hours or "period of use" hours, the change of engines can be determined by given time slots. The LDSS therefore creates an individual unit's time group for each engine. Refer to manual chapter »Engine time groups« for more details.</p> <p>Notes</p> <p>If the LDSS function »Fit service hours« (parameter ↩ 5755) is enabled with "Equal" or "Period of use" hours, this configuration gets valid. Otherwise this parameter can be ignored.</p> <p>For more details go to chapter ↩ "9.4.2.10 Group 11: Engine values".</p>
			[Off]	<p>No engine change will be performed. The engines are selected according to the setting of parameter ↩ 5755 (Fit service hours) with 1 hour spacing in case of load changes.</p>

ID	Parameter	CL	Setting range [Default]	Description
			All 32h All 64h All 128h	<p>All relevant engines are changed with a 32/64/128 hour spacing.</p> <p>Example 1</p> <ul style="list-style-type: none"> • "Changes of engines" is configured to "All 64h" • Generator 1 has 262 maintenance hours remaining • Generator 2 has 298 maintenance hours remaining • The time group for generator 1 is calculated as: $262\text{h}/64\text{h} = 4.09 = \text{Time group 4}$ • The time group for generator 2 is calculated as: $298\text{h}/64\text{h} = 4.66 = \text{Time group 4}$ • Both generators are in time group 4. <p>Time group 4 consists of any generator that the time group calculation total ranges from 4.00 through 4.99.</p> <p>In this instance the assigned generator number is used to determine which generator is brought online. Generator 1 will be started.</p> <p>Example 2</p> <ul style="list-style-type: none"> • "Changes of engines" is configured to "All 64h" • Generator 1 has 262 maintenance hours remaining • Generator 2 has 345 maintenance hours remaining • Generator 3 has 298 maintenance hours remaining • The time group for generator 1 is calculated as: $262\text{h}/64\text{h} = 4.09 = \text{Time group 4}$ • The time group for generator 2 is calculated as: $345\text{h}/64\text{h} = 5.39 = \text{Time group 5}$ • The time group for generator 3 is calculated as: $298\text{h}/64\text{h} = 4.66 = \text{Time group 4}$ • Generators 1 and 3 are in time group 4. • Time group 4 consists of any generator that the time group calculation total ranges from 4.00 through 4.99. • Generator 2 is in time group 5.

4 Configuration

4.4.5.5.3 Generator Selection

ID	Parameter	CL	Setting range [Default]	Description
				<ul style="list-style-type: none"> Time group 5 consists of any generator that the time group calculation total ranges from 5.00 through 5.99. <p>In this instance the largest time group will determine which generator is brought online. Generator 2 will be started because it is in time group 5.</p>
5777	LDSS sort priority always	2	On	<p>The priority is considered in each moment.</p> <p>The priority will be changed depending on priority input and running hours even with constant load.</p> <p>Notes</p> <p>This parameter is only effective if »Start stop mode« (parameter ↩ 5752) is configured to »Reserve power«.</p> <p>This feature can cause more start and stop sequences, even there is only one additional generator brought into the LDSS system.</p>
			[Off]	<p>The priority is depending on priority input and running hours but only considered, if the nominal power in the system changes. The nominal power changes when another generator is to stop or to start anyway.</p> <p>Notes</p> <p>This setting causes less generator changes and brings more calmness in the system.</p>
5759	Minimum running time	2	0 to 32000 s [180 s]	<p>If a genset has been started by the LDSS function, it continues to operate at least for this time even if it would have been stopped before.</p> <p>This timer is started with the closure of the GCB. If an emergency run is active (↩ 4.4.6 Emergency Run) and the mains return, this timer will be overridden and the load is transferred back to the mains after the mains settling time (parameter ↩ 2801) has expired.</p>

4.4.5.5.4 Islanded Parallel Operation (IOP)

General notes

In case of an islanded parallel operation (MCB open), the first genset will be connected to the de-energized busbar.



At least one genset must be in operation in islanded operation.

There are dedicated LDSS parameters for islanded parallel operation because the supply of the load is important here.

ID	Parameter	CL	Setting range [Default]	Description
5760	IOP Reserve power	2	1 to 999999 kW [100 kW]	The value configured for the reserve power determines when an additional generator will be started. The reserve power is the desired spinning reserve of a generator or generators. The reserve power is usually estimated as the largest load swing that a power plant may encounter during the time it takes to bring an additional generator online. The available generator power is calculated by adding up the generator real power ratings of all generators with closed GCBs. The reserve generator power is calculated by subtracting the power currently being produced by all generators with closed GCBs from the total available generator power. If the actual reserve power of the generators is less than the value configured in this parameter, the next generator will be started.
				Currently available total generator rated real power
			-	Currently available total generator actual real power
			=	Reserve power
				Notes This parameter is only effective if start stop mode (parameter ↩> 5752) is configured to "Reserve power". It is also possible to change the effective reserve power via interface (refer to ↩> "Remote LDSS IOP reserve power").

4 Configuration

4.4.5.5.4 Islanded Parallel Operation (IOP)

ID	Parameter	CL	Setting range [Default]	Description
5648	IOP Reserve power 2	2	1 to 999999 kW [200 kW]	<p>The value configured for the reserve power determines when an additional generator will be started. The reserve power is the desired spinning reserve of a generator or generators. The reserve power is usually estimated as the largest load swing that a power plant may encounter during the time it takes to bring an additional generator online.</p> <p>The available generator power is calculated by adding up the generator real power ratings of all generators with closed GCBs. The reserve generator power is calculated by subtracting the power currently being produced by all generators with closed GCBs from the total available generator power.</p> <p>If the actual reserve power of the generators is less than the value configured in this parameter, the next generator will be started.</p>
				Currently available total generator rated real power
			-	Currently available total generator actual real power
			=	Reserve power
				<p>Notes</p> <p>This parameter is only effective if start stop mode (parameter 5752) is configured to "Reserve power".</p>
12604	IOP Reserve power 2	2	<p>Determined by LogicsManager 86.41</p> <p>[(0 & 1) & 1]</p> <p>= 11975</p>	<p>Once the conditions of the LogicsManager have been fulfilled, the 'IOP Reserve power 2' (parameter 5648) is used instead of the 'IOP Reserve power' (parameter 5760).</p> <p>Notes</p> <p>For information on the LogicsManager and its default settings see 9.3.1 LogicsManager Overview".</p>
5761	IOP Hysteresis	2	1 to 65000 kW [20 kW]	<p>If the reserve power is sufficient to stop one genset without falling below the threshold and the hysteresis configured here, a genset will be stopped.</p> <p>Notes</p> <p>This parameter is only effective if start stop mode (parameter 5752)</p>

ID	Parameter	CL	Setting range [Default]	Description
				5752) is configured to "Reserve power".
5762	IOP Max. generator load	2	0 to 100% [70%]	<p>If the generator load exceeds the threshold configured here, the load-dependent start/stop function will start another genset.</p> <p>Notes</p> <p>This parameter is only effective if start stop mode (parameter ↩> 5752) is configured to "Generator load".</p> <p>The maximum generator load must be configured higher than the minimum generator load for proper operation.</p>
5763	IOP Min. generator load	2	0 to 100% [30%]	<p>If the generator load falls below the threshold configured here, the load-dependent start/stop function will stop a genset. If only a few gensets are operating in a multi-genset application, the IOP Dynamic (parameter ↩> 5757) will also be considered when stopping a genset.</p> <p>Notes</p> <p>This parameter is only effective if start stop mode (parameter ↩> 5752) is configured to "Generator load".</p> <p>The maximum generator load must be configured higher than the minimum generator load for proper operation.</p>
5757	IOP Dynamic	2		<p>The dynamic determines when to start or stop the next genset and shows the following behavior:</p> <p>Starting genset</p> <p>The control requests a certain amount of additional load depending on the dynamic. It may start two or more gensets to supply the required load. Also refer to the following example.</p> <p>Stopping genset</p> <p>The dynamic determines how soon a genset will be stopped. It prevents continuous start and stop if only a few gensets are in operation. In this case, the remaining gensets would not reach the maximum limit if one genset stops (if, for example, two gensets with 100 kW rated load, a minimum load of 40 % and a maximum load of 70 % are operated, the second genset will be shut down if both reach 40 kW</p>

4 Configuration

4.4.5.5.4 Islanded Parallel Operation (IOP)

ID	Parameter	CL	Setting range [Default]	Description
				and the remaining engine would operate with 80 kW and request the next engine and so on). The more gensets are running, the less the influence of this parameter. Also refer to the following example.
			[Low]	<p>Starting genset</p> <p>A larger genset is requested and it will take longer until the next change is required. The engines are operated with more reserve power. The requested load is calculated so that the gensets will be loaded with 25 % of the range between minimum and maximum generator load (parameters ↩ 5762 & ↩ 5763) after the new genset has been started.</p> <p>Stopping genset</p> <p>The genset will shut down at a lower limit and be operated longer. The number of gensets in operation will remain constant for a wider range of load. The load on the remaining gensets must not exceed 25 % of the range between minimum and maximum generator load (parameters ↩ 5762 & ↩ 5763).</p>
			Moderate	<p>Starting genset</p> <p>A medium genset is requested. The requested load is calculated so that the gensets will be loaded with 50 % of the range between minimum and maximum generator load (parameters ↩ 5762 & ↩ 5763) after the new genset has been started.</p> <p>Stopping genset</p> <p>The load on the remaining gensets must not exceed 50 % of the range between minimum and maximum generator load (parameters ↩ 5762 & ↩ 5763).</p>
			Strong	<p>Starting genset</p> <p>A smaller genset is requested to operate the engines with higher efficiency. This may lead to more frequent starts and stops. The requested load is calculated so that the gensets will be loaded with 75 % of the range between minimum and maximum generator load (parameters ↩ 5762 & ↩ 5763) after the new genset has been started.</p>

ID	Parameter	CL	Setting range [Default]	Description
				<p>Stopping genset</p> <p>The genset will be shut down earlier. This may lead to more frequent starts and stops. The load on the remaining gensets must not exceed 75 % of the range between minimum and maximum generator load (parameters ↩ 5762 & ↩ 5763).</p>
				<p>Notes</p> <p>This parameter is only effective if start stop mode (parameter ↩ 5752) is configured to "Generator load".</p>
				<p>Example (Starting genset)</p> <p>A plant made up of several gensets with a rated power of 50, 100, and 200 kW is configured to a maximum generator load of 70 % and a minimum generator load of 40 %. One genset with 200 kW is running and the actual load reaches 140 kW. This is the 70 % maximum load limit of the running genset and requires the start of the next genset.</p> <ul style="list-style-type: none"> • Low: a total generator rated power of 294.7 kW is requested and a 100 kW genset will be started. • Moderate: a total generator rated power of 254.5 kW is requested and a 100 kW genset will be started. • High: a total generator rated power of 224.0 kW is requested and a 50 kW genset will be started. <p>Refer to ↩ 9.6.2 Load Dependent Start Stop (LDSS) Formulas for details about the formulas used for calculation.</p>
				<p>Example (Stopping genset)</p> <p>Two gensets with the same rated power are configured to a maximum generator load of 70 % and a minimum generator load of 40 %.</p> <p>The following example shows the load level before stopping the second genset and the resulting load level for the first genset depending on the dynamic setting.</p> <ul style="list-style-type: none"> • Low:

4 Configuration

4.4.5.5.4 Islanded Parallel Operation (IOP)

ID	Parameter	CL	Setting range [Default]	Description
				<p>Load level before stopping: 23.75%</p> <p>Resulting load level for remaining engine: 47.5% (25% of the difference between 70 and 40%)</p> <ul style="list-style-type: none"> Moderate: <p>Load level before stopping: 27.5%</p> <p>Resulting load level for remaining engine: 55% (50% of the difference between 70 and 40%)</p> High: <p>Load level before stopping: 31.25%</p> <p>Resulting load level for remaining engine: 62.5% (75% of the difference between 70 and 40%)</p>
5764	IOP Add on delay	2	0 to 32000 s [10 s]	<p>Load swings may exceed the threshold momentarily. In order to prevent the engine from starting due to short-term load swings, a delay time may be configured.</p> <p>The LDSS criterion for adding load must be exceeded without interruption for this delay time, configured in seconds, prior to a start command being issued.</p> <p>If the LDSS criterion for adding load is fallen below before the delay time expires, the delay time is reset and a start command is not issued.</p>
5765	IOP Add on delay at rated load	2	0 to 32000 s [3 s]	<p>The command to start the next genset in case a genset exceeds rated load will be issued after the delay configured here has expired.</p> <p>Notes</p> <p>This parameter becomes only effective in case a genset exceeds rated load to achieve a faster start and overrides parameter 5764.</p>
5766	IOP Add off delay	2	0 to 32000 s [60 s]	<p>Load swings may fall below the threshold momentarily. In order to prevent the engine from stopping due to short-term load swings, a delay time may be configured.</p> <p>The load must remain below the hysteresis setpoint without interruption for the delay time,</p>

ID	Parameter	CL	Setting range [Default]	Description
				configured in seconds, prior to a stop command being issued. If the load exceeds the hysteresis setpoint before the delay time expires, the delay time is reset and a stop command is not issued.

4.4.5.5.5 Mains Parallel Operation

General notes

In case of a mains parallel operation (MCB closed), load-dependent start stop is only enabled, if the gensets participates in load sharing at the interchange point (all participating gensets must be configured to the same setpoint).



A minimum load threshold must be exceeded to start the first genset, i.e. a genset will only be started if a minimum load would be demanded from the generator.

There are dedicated LDSS parameters for mains parallel operation.

ID	Parameter	CL	Setting range [Default]	Description
5767	MOP Minimum load	2	0 to 65000 kW [10 kW]	For the mains interchange (import/export) real power control to function, a minimum generator power setpoint value is required to start the first genset. In many cases, it is desirable that the engine is prevented from starting unless the generator will operate at a specific kW level or higher to ensure a reasonable degree of efficiency. Example The mains interchange must reach a level that will permit an 80 kW generator to operate at a minimum load of 40 kW prior to the engine starting.
5769	MOP Hysteresis	2	0 to 65000 kW [10 kW]	Start stop mode configured to "Reserve power": If the reserve power is sufficient to stop one genset without falling below the reserve power threshold and the hysteresis configured here, a genset will be stopped. If the generator load falls below the minimum load threshold minus the hysteresis configured here, the last genset will be stopped.

4 Configuration

4.4.5.5.5 Mains Parallel Operation

ID	Parameter	CL	Setting range [Default]	Description
				<p>Notes</p> <p>The importance of this parameter depends on the setting of the start stop mode (parameter ↩ 5752).</p> <p>It is also possible to change the effective reserve power via interface (refer to ↩ "Remote LDSS MOP reserve power").</p>
5768	MOP Reserve power	2	0 to 999999 kW [50 kW]	<p>The minimum reserve power in mains parallel operation is configured here. This is the maximum expected load swing on the busbar, which shall be supported by the gensets.</p> <p>If the reserve power falls below this value, the load-dependent start/stop function will start another genset.</p> <p>Notes</p> <p>This parameter is only effective if start stop mode (parameter ↩ 5752) is configured to "Reserve power".</p>
5649	MOP Reserve power 2	2	0 to 999999 kW [100 kW]	<p>The minimum reserve power in mains parallel operation is configured here. This is the maximum expected load swing on the busbar, which shall be supported by the gensets.</p> <p>If the reserve power falls below this value, the load-dependent start/stop function will start another genset.</p> <p>Notes</p> <p>This parameter is only effective if start stop mode (parameter ↩ 5752) is configured to "Reserve power".</p>
12605	MOP Reserve power 2	2	Determined by LogicsManager 86.42 [(0 & 1) & 1] = 11976	<p>Once the conditions of the LogicsManager have been fulfilled, the 'MOP Reserve power 2' (parameter ↩ 5649) is used instead of the 'MOP Reserve power' (parameter ↩ 5768).</p> <p>Notes</p> <p>For information on the LogicsManager and its default settings see ↩ "9.3.1 LogicsManager Overview".</p>
5770	MOP Max. generator load	2	0 to 100% [70%]	<p>If the generator load exceeds the threshold configured here, the</p>

ID	Parameter	CL	Setting range [Default]	Description
				<p>load-dependent start/stop function will start another genset.</p> <p>Notes</p> <p>This parameter is only effective if start stop mode (parameter ↪ 5752) is configured to "Generator load".</p> <p>The maximum generator load must be configured higher than the minimum generator load for proper operation.</p>
5771	MOP Min. generator load	2	0 to 100% [30%]	<p>If the generator load falls below the threshold configured here, the load-dependent start/stop function will stop a genset.</p> <p>If only a few gensets are operating in a multi-genset application, the MOP Dynamic (parameter ↪ 5758) will also be considered when stopping a genset.</p> <p>Notes</p> <p>This parameter is only effective if start stop mode (parameter ↪ 5752) is configured to "Generator load".</p> <p>The maximum generator load must be configured higher than the minimum generator load for proper operation.</p>
5758	MOP Dynamic	2		<p>The dynamic determines when to start or stop the next genset and shows the following behavior:</p> <p>Starting genset</p> <p>The Dynamic is only considered for the start sequence if "Fit size of engines" is enabled (refer to parameter ↪ 5754).</p> <p>The control requests a certain amount of additional load depending on the dynamic. It may start two or more gensets to supply the required load.</p> <p>Stopping genset</p> <p>The dynamic determines how soon a genset will be stopped. It prevents continuous start and stop if only a few gensets are in operation.</p> <p>In this case, the remaining gensets would not reach the maximum limit if one genset stops (if, for example, two gensets with 100 kW rated load, a minimum load of 40 % and a maximum load of 70 % are operated, the second</p>

ID	Parameter	CL	Setting range [Default]	Description
				<p>genset will be shut down if both reach 40 kW and the remaining engine would operate with 80 kW and request the next engine and so on).</p> <p>The more gensets are running, the less the influence of this parameter. Also refer to the following example.</p>
			<p>[Low]</p>	<p>Starting genset</p> <p>A larger genset is requested and it will take longer until the next change is required. The engines are operated with more reserve power. The requested load is calculated so that the gensets will be loaded with 25 % of the range between minimum and maximum generator load (parameters ↩ 5762 & ↩ 5763) after the new genset has been started.</p> <p>Stopping genset</p> <p>The genset will shut down at a lower limit and be operated longer. The number of gensets in operation will remain constant for a wider range of load. The load on the remaining gensets must not exceed 25 % of the range between minimum and maximum generator load (parameters ↩ 5762 & ↩ 5763).</p>
			<p>Moderate</p>	<p>Starting genset</p> <p>A medium genset is requested. The requested load is calculated so that the gensets will be loaded with 50 % of the range between minimum and maximum generator load (parameters ↩ 5762 & ↩ 5763) after the new genset has been started.</p> <p>Stopping genset</p> <p>The load on the remaining gensets must not exceed 50 % of the range between minimum and maximum generator load (parameters ↩ 5762 & ↩ 5763).</p>
			<p>High</p>	<p>Starting genset</p> <p>A smaller genset is requested to operate the engines with higher efficiency. This may lead to more frequent starts and stops. The requested load is calculated so that the gensets will be loaded with 75 % of the range between minimum and maximum generator load (parameters ↩).</p>

ID	Parameter	CL	Setting range [Default]	Description
				<p>5762 & ↩ 5763) after the new genset has been started.</p> <p>Stopping genset</p> <p>The genset will be shut down earlier. This may lead to more frequent starts and stops. The load on the remaining gensets must not exceed 75 % of the range between minimum and maximum generator load (parameters ↩ 5762 & ↩ 5763).</p> <p>Notes</p> <p>This parameter is only effective if start stop mode (parameter ↩ 5752) is configured to "Generator load".</p> <p>Refer to parameter ↩ 5757 for examples on stating and stopping a genset depending on the dynamic setting.</p>
5772	MOP Add on delay	2	0 to 32000 s [20 s]	<p>Load swings may exceed the threshold momentarily. In order to prevent the engine from starting due to short-term load swings, a delay time may be configured.</p> <p>The LDSS criterion for adding load must be exceeded without interruption for this delay time, configured in seconds, prior to a start command being issued.</p> <p>If the LDSS criterion for adding load is fallen below before the delay time expires, the delay time is reset and a start command is not issued.</p>
5773	MOP Add on delay at rated load	2	0 to 32000 s [3 s]	<p>The command to start the next genset in case a genset exceeds rated load will be issued after the delay configured here has expired.</p> <p>This parameter becomes only effective in case a genset exceeds rated load to achieve a faster start and overrides parameter ↩ 5772.</p> <p>Notes</p> <p>This parameter becomes only effective in case a genset exceeds rated load to achieve a faster start and overrides parameter ↩ 5764.</p>
5774	MOP Add off delay	2	0 to 32000 s [60 s]	<p>Load swings may fall below the threshold momentarily. In order to prevent the engine from stopping due to short-term load swings, a delay time may be configured.</p>

ID	Parameter	CL	Setting range [Default]	Description
				<p>The load must remain below the hysteresis setpoint without interruption for the delay time, configured in seconds, prior to a stop command being issued.</p> <p>If the load exceeds the hysteresis setpoint before the delay time expires, the delay time is reset and a stop command is not issued.</p>

4.4.5.5.6 LDSS with predicted load

For further information, please refer to application examples to [↪ “6.3.17 LDSS with predicted load”](#).



In the application mode "GCB/GC" **A13** the LDSS with predicted load is not available.

Introduction

In case of a mains failure, the usual LDSS function of the easYgen starts either one or all generators. This is done so because during the mains failure the consumer load information is lost. The LDSS with predicted load (LDSS PL) can start the correct amount of generators based on the last mains power measurements (5-minutes average value).

The LDSS PL takes the 5-minutes average value as mains load into account and passes it to the LDSS function as consumer load. The LDSS function can thereby start the correct amount of gensets according to that predicted load. A prerequisite for this function is the availability of a group breaker (GGB) in the application. The GGB allows to switch the correct amount of generators onto the load.

- The LDSS PL differentiates two source modes as base for the predicted consumer load calculation:
 - 1. Internal source mode: The mains power and breaker handling is provided by the easYgenXT.
 - 2. External source mode: The mains power, the MCB and GGB control is provided by an external device (e.g. ATS), connected via CANopen with easYgen.

General

To the time the engines are not started and the mains is feeding the load the LDSS PL calculates a mains load with a 5-minute average value. This load value is passed to the LDSS function as consumer load. So the LDSS can determine the correct amount of engines which must be started if a start command becomes active. See [↪ “General”](#): Switches are in “Pos.1” and “Pos. A”.

In the moment the start request becomes active the average load calculation is frozen. See [↪ “General”](#): switches are in “Pos.2” and “Pos. A”.

If all requested engines are successful started and have closed their GCBs the LDSS PL gives the release for closing the GGB. From this time on the 5-minute average load calculation will be fed with the easYgen calculated generator load. See [General](#): switches are in "Pos.3"; "Pos. B"

The LDSS function now does not differ anymore to the original function. There will be started and stopped the correct generators according to the common LDSS parameters.

The External and Internal Source Mode

There is an "External" and an "Internal" mode available (configurable by parameter 9066 "Predicted load source"):

The external source mode is dedicated for external installed ATS controls which measure the mains power. The system allows up to 5 ATS controls at the Interchange point.

In this mode, external ATS controls send information via CANopen RPDO messages. The easYgen provides information going to the ATS control.

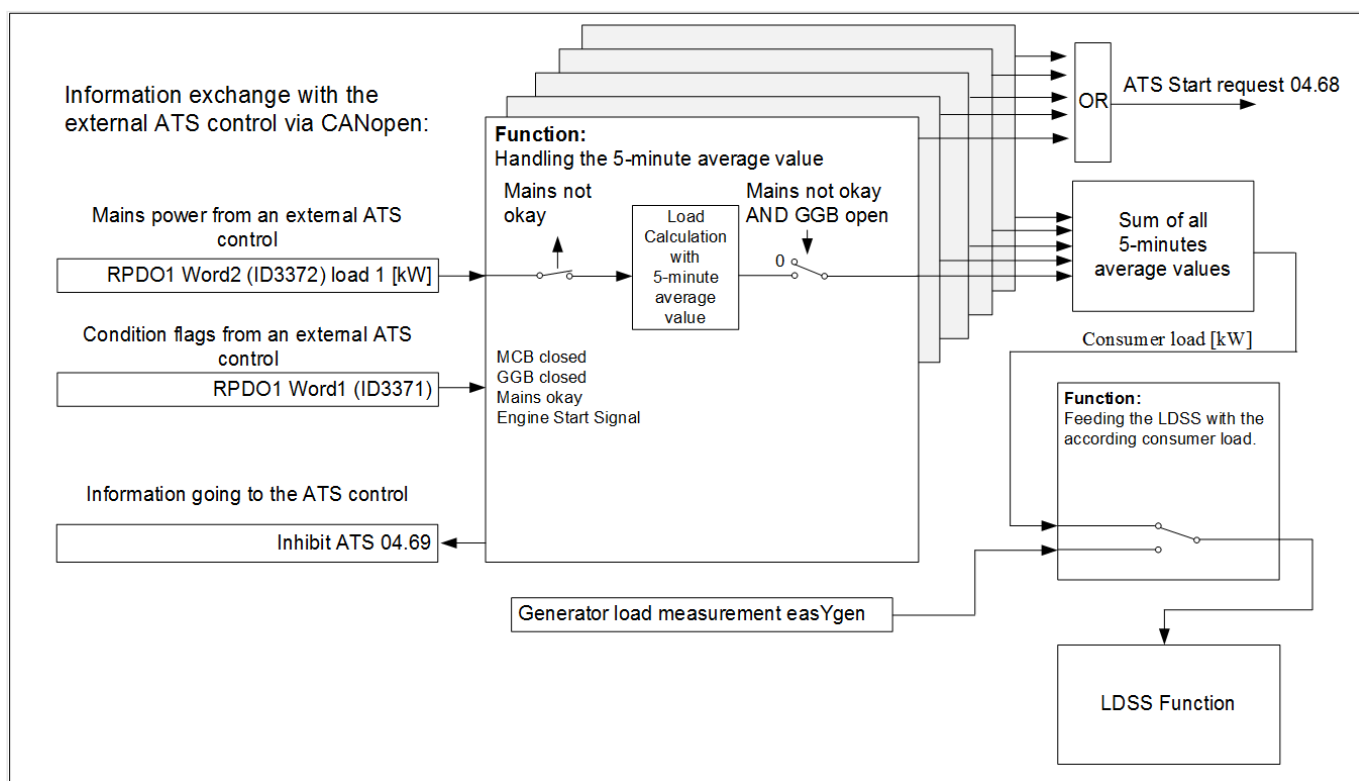

Fig. 210: External mode

The **internal source mode** is dedicated to use the own mains power measurement assigned via Analogmanager .

4 Configuration

4.4.5.5.6 LDSS with predicted load

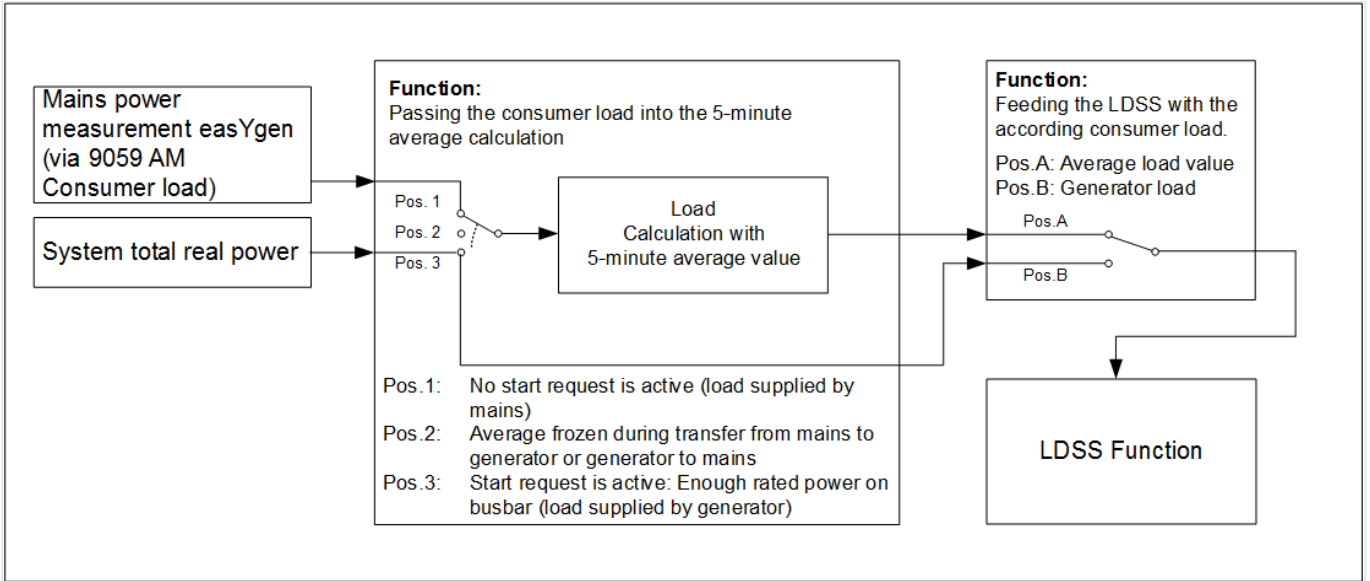

Fig. 211: **Internal mode**

The external ATS control sends information in CANopen RPDO messages. The easYgen provides information going to the ATS control.

ID	Parameter	CL	Setting range [Default]	Description
15026	LDSS with predicted load	2	Determined by LogicsManager 86.36 [(0 & 1) & 1]	If the conditions of this LogicsManager have been fulfilled LDSS is working with predicted load. Otherwise LDSS is working normally.
9066	Predicted load source	2	Internal [External]	Internal: LDSS with predicted load is using internal data. ("86.09 LM: Start req.in AUTO") and "81.30 AM Consumer load [kW]") External: LDSS with predicted load is expected data from external via RPDOs
9059	AM Consumer load [kW]	2	AnalogManager [↪ "9.4.3 Factory Settings"]	The result (81.30) of this analog manager provides the load for the load prediction in internal source mode

4.4.6 Emergency Run

General notes



The automatically start by mains trip is possible only in application mode **A04**, **A06**, **A07**, **A08**, **A09**, **A11**, **A12** and **A13** (2 power circuit breakers).

If the LogicsManager outputs 'Stop request in AUTO' or 'Inhibit emergency run' are TRUE, an emergency power operation may be prevented or interrupted from an external source.



Prerequisites

- The emergency power function can only be activated for synchronous generators with parameter [↪ 2802](#).
- Emergency power is carried out in operating mode AUTOMATIC regardless of the status of the LogicsManager output 'Start request in AUTO' (LogicsManager).

The display indicates "Emergency run" during emergency power operation.

The following principles are observed in case of an emergency power operation:

- If an emergency power operation is initiated, the engine is started automatically, unless the start sequence is interrupted via an alarm or prevented via the LogicsManager or the operating mode is changed.
- The GCB can be closed regardless of the engine delay time if the generator frequency and voltage are within the configured operating limits ([↪ "4.5.1.1 Generator Operating Ranges: Voltage / Frequency / Busbar"](#)) if the parameter "Undelay close GCB" (parameter [↪ 12210](#)) has been set accordingly (default setting).
- If the mains return during an emergency power operation (GCB is closed), the mains settling time (parameter [↪ 2801](#)) must expire before the load is transferred from the generator to mains operation.



Activation of emergency power

If the mains are not within the configured frequency and voltage operating limits ([↪ "4.5.3.3 Mains Operating Ranges"](#)) for at least the time configured in the parameter "Mains fail delay time" (parameter [↪ 2800](#)), an emergency power operation is activated.



MCB malfunction

An emergency power operation will be performed, if the control is not able to close or re-close the MCB and the alarm "Fail to close MCB" occurs.



Mains rotation field alarm

If the mains returns after a mains failure with a reversed rotation direction the generator remains in emergency power operation until the mains rotation matches the rotation of the generator set.

The generator will not start upon a mains rotation field alarm, but it will keep on running if it has already started.



The following parameters **only** apply to application mode **A04**, **A06**, **A07**, **A08**, **A09**, **A11**, **A12** and **A13**. In application mode GCB/GC **A13** some of the following parameters are ignored.



Application mode GCB/GC A13

In application mode GCB/GC **A13** the GC has the information about the conditions of the single segments in the whole Layer 3 system. The emergency start of the easYgen(s) in the group depend on the segments which are configured in the GC device. The GCs receive the measured voltages of the segments from LS-6XT. The GC monitors the configured segment(s). If at least one segment is recognized as out of the operating ranges, the generators in the own group are getting an emergency run start signal. With successful start the generator(s) close its breaker. The GGB breaker closure is to coordinate with a logic inside the GC (LogicsManager equations) or by a PLC which gives the close command.

ID	Parameter	CL	Setting range [Default]	Description
2802	Emergency run	2	[On]	If the unit is in the AUTOMATIC operating mode and a mains fault occurs according to the following parameters, the engine is started and an automatic emergency operation is carried out.
			Off	No emergency operation is carried out.
2800	Mains fail delay time (Mains failure start delay)	2	0.00 to 655.00 s [3.00 s]	To start the engine and to carry out an emergency operation the monitored mains must be failed continuously for the minimum period of time set with this parameter.
			Notes This delay time starts only if the easYgen is in AUTOMATIC operating mode and emergency power is activated. This parameter is not valid in A13 .	
3408	Emerg. start with MCB failure	2	[Yes] No	Emergency power operations may be configured with the failure of the MCB in addition to a loss of power on the mains supply.

ID	Parameter	CL	Setting range [Default]	Description
				<p>Notes</p> <p>An MCB breaker alarm is indicated if parameter "MCB monitoring" (parameter ↩ 2620) is configured "On".</p> <p>This parameter is not valid in A13.</p>
2839	Emerg. open MCB immediately	2	[No]	The MCB breaker opens after the engine is in operation and the condition for closing the GCB are active (frequency and voltage inside the configured operation ranges).
			Yes	The MCB breaker opens if the emergency power operation is active.
12200	Inhibit emerg.run (Inhibit emerg. run)	2	Determined by LogicsManager 86.11 [(0 & 1) & 1] = 10710	<p>Once the conditions of the LogicsManager have been fulfilled the emergency power operation will be terminated or blocked.</p> <p>Notes</p> <p>It is possible to interrupt an already activated emergency run.</p> <p>For information on the LogicsManager and its default settings see ↩ "9.3.1 LogicsManager Overview".</p> <p>This parameter is not valid in A13.</p>
4101	Break emerg. in critical mode (Override emergency operations in critical mode)	2	0 to 999 s [5 s]	The emergency power operations are overridden for the configured time when the critical mode starts in order to supply the complete generator power to the sprinkler pump.

In the application mode GCB/GC **A13** the configuration of the emergency start segment numbers of the easYgen are ignored. They must be configured at the GC.

ID	Parameter	CL	Setting range [Default]	Description
2805	Emergency start Seg No 1-16	2	—	In the application mode GCB/LSx the easYgen provides an emergency run according to the configured segments. If the operating range of the particular segment is lost, the easYgen starts and closes the GCB. When the easYgen has recognized being parallel to mains it ramps down and opens the breaker with cool down. The entry is bit wise. ToolKit offers therefore a more comfortable configuration. In the easYgen display must be entered

4 Configuration

4.4.6 Emergency Run

ID	Parameter	CL	Setting range [Default]	Description
				<p>a hexadecimal value related to the segment number.</p> <p>Notes</p> <p>This parameter only applies to application mode A07.</p>
2806	Emergency start Seg No 17-32	2	—	<p>In the application mode GCB/LSx the easYgen provides an emergency run according to the configured segments. If the operating range of the particular segment is lost, the easYgen starts and closes the GCB. When the easYgen has recognized being parallel to mains it ramps down and opens the breaker with cool down. The entry is bit wise. ToolKit offers therefore a more comfortable configuration. In the easYgen display must be entered a hexadecimal value related to the segment number.</p> <p>Notes</p> <p>This parameter only applies to application mode A07.</p>
2807	Emergency start Seg No 33-48	2	—	<p>In the application mode GCB/LSx the easYgen provides an emergency run according to the configured segments. If the operating range of the particular segment is lost, the easYgen starts and closes the GCB. When the easYgen has recognized being parallel to mains it ramps down and opens the breaker with cool down. The entry is bit wise. ToolKit offers therefore a more comfortable configuration. In the easYgen display must be entered a hexadecimal value related to the segment number.</p> <p>Notes</p> <p>This parameter only applies to application mode A07.</p>
2808	Emergency start Seg No 49-64	2	—	<p>In the application mode GCB/LSx the easYgen provides an emergency run according to the configured segments. If the operating range of the particular segment is lost, the easYgen starts and closes the GCB. When the easYgen has recognized being parallel to mains it ramps down and opens the breaker with cool down. The entry is bit wise. ToolKit offers therefore a more comfortable configuration. In the easYgen display must be entered a hexadecimal value related to the segment number.</p> <p>Notes</p>

ID	Parameter	CL	Setting range [Default]	Description
				This parameter only applies to application mode A07 .

4.5 Configure Monitoring



Replacement: "Delayed by engine speed" becomes "Enabled"

Formerly (non-XT easYgen) several monitoring functions could be delayed each by use of parameter "Delayed by engine speed". Exchanging it by the new parameter "Enabled" introduces the one-change-switch of all monitoring functions by LogicsManager 11459 "87.70 LM: Release eng.mon."

With software revision 1.13 or higher each monitoring LogicsManager can be enabled alternatively by one of 32 Flags.

Factory settings ensure same behavior of each affected monitoring function as of non-XT easYgen series before.

4.5.1 Configure Generator Monitoring

4.5.1.1 Generator Operating Ranges: Voltage / Frequency / Busbar



The operating voltage/frequency/busbar parameters are used to check if the values are in range when performing a dead bus closure and synchronization of the generator. Busbar 1 must be within this ranges to synchronize the generator to the busbar.

It is recommended to configure the operating limits within the monitoring limits.

ID	Parameter	CL	Setting range [Default]	Description
5800	Upper voltage limit (Generator maximum operating voltage limit)	2	100 to 150% [110%] (Hysteresis: 1%)	The maximum permissible positive deviation of the generator voltage from the generator rated voltage (parameter ↔ 1766) is configured here. This value may be used as a voltage limit switch. The conditional state of this switch may be used as a command variable for the LogicsManager (02.03).
5801	Lower voltage limit (Generator minimum operating voltage limit)	2	50 to 100% [90%] (Hysteresis: 1%)	The maximum permissible negative deviation of the generator voltage from the generator rated voltage (parameter ↔ 1766) is configured here.

ID	Parameter	CL	Setting range [Default]	Description
				This value may be used as a voltage limit switch. The conditional state of this switch may be used as a command variable for the LogicsManager (02.03).
5802	Upper frequency limit (Generator maximum operating frequency limit)	2	100.0 to 150.0% [105.0%] (Hysteresis: 0.05%)	The maximum permissible positive deviation of the generator frequency from the rated system frequency (parameter 1750) is configured here. This value may be used as a frequency limit switch. The conditional state of this switch may be used as a command variable for the LogicsManager (02.04).
5803	Lower frequency limit (Generator minimum operating frequency limit)	2	50.0 to 100.0% [95.0%] (Hysteresis: 0.05%)	The maximum permissible negative deviation of the generator frequency from the rated system frequency (parameter 1750) is configured here. This value may be used as a frequency limit switch. The conditional state of this switch may be used as a command variable for the LogicsManager (02.04).

Table 73: Parameter settings: Voltage/frequency

Busbar monitoring

Busbar monitoring compares the actual voltage and frequency of the busbar with the configured generator operating ranges. The voltage operating range is configured with the "Upper voltage Limit" and "Lower voltage limit" parameter. The frequency operating range is configured with the "Upper frequency limit" and "Lower frequency limit" parameter. If the measured busbar voltage or frequency deviates from the operating range for a time exceeding the configurable delay, an alarm will be issued.

ID	Parameter	CL	Setting range [Default]	Description
5118	Monitoring	2	On	Monitoring is enabled
			[Off]	Monitoring is disabled
5122	Delay	2	0.02 to 99.99 s [10.00 s]	If one of the monitored values exceeds the threshold value for the delay time configured here, an alarm will be issued.
5119	Alarm class	2	Class A, Class B, Class C, Class D, Class E, Class F, Control [Class B]	Each limit may be assigned an independent alarm class that specifies what action should be taken when the limit is surpassed.
				Notes

ID	Parameter	CL	Setting range [Default]	Description
				For additional information refer to 9.5.4 Alarm Classes
5120	Self acknowledge	2	Yes	The control unit automatically clears the alarm if the fault condition is no longer detected.
			[No]	The control unit does not automatically reset the alarm when the fault condition is no longer detected. The alarm must be acknowledged and reset by manually pressing the appropriate buttons or by activating the LogicsManager output "External acknowledgment" (via a discrete input or via an interface).

Table 74: Parameter settings: Busbar

4.5.1.2 Generator Voltage Monitoring

ID	Parameter	CL	Setting range [Default]	Description
1770	Generator voltage monitoring	2		The unit can either monitor the phase-neutral (wye) voltages or the phase-phase (delta) voltages. If the controller is used in a compensated or isolated network, voltage protection monitoring should be configured as phase-neutral to prevent earth-faults resulting in tripping of the voltage protections.
			[Phase - phase]	The phase-phase voltage will be monitored and all subsequent parameters concerning voltage monitoring "generator" are referred to this value (V_{L-L}).
			Phase - neutral	The phase-neutral voltage will be monitored and all subsequent parameters concerning voltage monitoring "generator" are referred to this value (V_{L-N}).
				Notes WARNING: This parameter defines how the protective functions operate.

Table 75: Settings: Generator Voltage Monitoring

4.5.1.2.1 Generator Overvoltage (Level 1 & 2) ANSI# 59

General notes

Voltage is monitored according to how the parameter "Generator voltage measuring" (parameter [↩➤ 1851](#)) is configured. This controller provides the user with two alarm levels for generator overvoltage. Both alarms are definite time alarms.

Monitoring for overvoltage faults is performed in two steps.



If this protective function is triggered, the display indicates "Gen. overvoltage 1" or "Gen. overvoltage 2" and the logical command variable "06.05" or "06.06" will be enabled.

Refer to [↩➤ "9.1.1 Triggering Characteristics"](#) for the triggering characteristic of this monitoring function. The diagrams listed there show a frequency trend and the associated pickup times and length of the alarms.



The parameter limits listed below have identical setting ranges. Each parameter may be configured with different settings to create unique trip characteristics for specific thresholds.

ID	Parameter	CL	Setting range [Default]	Description
2000 2006	Monitoring	2	[On]	Overvoltage monitoring is carried out according to the following parameters. Monitoring is performed at two levels. Both values may be configured independent from each other (prerequisite: Level 1 limit < limit 2).
			Off	Monitoring is disabled for Level 1 limit and/or Level 2 limit.
2004 2010	Limit	2	50.0 to 150.0% 2004: [108.0%] 2010: [112.0%] (Hysteresis: 0.7%) (Reset Delay: 80 ms)	The percentage values that are to be monitored for each threshold limit are defined here. If this value is reached or exceeded for at least the delay time without interruption, the action specified by the alarm class is initiated.
			Notes This value refers to the System rated frequency (parameter ↩➤ 1766).	
2005 2011	Delay	2	0.02 to 99.99 s 2005: [5.00 s] 2011: [0.30 s]	If the monitored generator voltage value exceeds the threshold value for the delay time configured here, an alarm will be issued.
			Notes If the monitored generator voltage falls below the threshold (minus	

ID	Parameter	CL	Setting range [Default]	Description
				the hysteresis) before the delay expires the time will be reset.
2001 2007	Alarm class	2	Class A, Class B, Class C, Class D, Class E, Class F , Control 2001: [Class B] 2007: [Class F]	Each limit may be assigned an independent alarm class that specifies what action should be taken when the limit is surpassed. Notes For additional information refer to 9.5.4 Alarm Classes
2002 2008	Self acknowledge	2 4	Yes [No]	The control unit automatically clears the alarm if the fault condition is no longer detected. The control unit does not automatically reset the alarm when the fault condition is no longer detected. The alarm must be acknowledged and reset by manually pressing the appropriate buttons or by activating the LogicsManager output "External acknowledgment" (via a discrete input or via an interface).
2003 2009	Enabled	2 4	[Always] 87.70 LM:Eng.mon For xx = 1 to 32: 96.{xx} LM: Flag{xx}	Monitoring for this fault condition is continuously enabled. Monitoring for fault conditions is not performed until engine monitoring is enabled. This is determined through the LogicsManager equation "Release engine monitoring". The monitoring is executed, if the LogicsManager "Flag {xx}" is TRUE. Example: 96.01 LM: Flag 1, 96.02 LM: Flag 2, ..., 96.32 LM: Flag 32

4.5.1.2.2 Generator Undervoltage (Level 1 & 2) ANSI# 27

General notes

Voltage is monitored according to how the parameter "Generator voltage measuring" (parameter [1851](#)) is configured. This controller provides the user with two alarm levels for generator undervoltage. Both alarms are definite time alarms.

Monitoring for undervoltage faults is performed in two steps.



If this protective function is triggered, the display indicates "Gen. undervoltage 1" or "Gen. undervoltage 2" and the logical command variable "06.07" or "06.08" will be enabled.

Refer to [↗](#) “9.1.1 Triggering Characteristics” for the triggering characteristic of this monitoring function. The diagrams listed there show a frequency trend and the associated pickup times and length of the alarms.

 The parameter limits listed below have identical setting ranges. Each parameter may be configured with different settings to create unique trip characteristics for specific thresholds.

 This monitoring function is disabled when the idle mode ([↗](#) “4.4.1.4 Idle Mode”) is active.

ID	Parameter	CL	Setting range [Default]	Description
2050 2056	Monitoring	2	[On] Off	Undervoltage monitoring is carried out according to the following parameters. Monitoring is performed at two levels. Both values may be configured independent from each other (prerequisite: Level 1 limit < limit 2). Monitoring is disabled for Level 1 limit and/or Level 2 limit.
2054 2060	Limit	2	50.0 to 150.0% 2054: [92.0%] 2060: [88.0%] (Hysteresis: 0.7%) (Reset Delay: 80 ms)	The percentage values that are to be monitored for each threshold limit are defined here. If this value is reached or exceeded for at least the delay time without interruption, the action specified by the alarm class is initiated. Notes This value refers to the System rated frequency (parameter ↗ 1766).
2055 2061	Delay	2	0.00 to 999.00 s 2055: [5.00 s] 2061: [0.30 s]	If the monitored generator voltage value falls below the threshold value for the delay time configured here, an alarm will be issued. Notes If the monitored generator voltage exceeds the threshold (plus the hysteresis) before the delay expires the time will be reset.
2051 2057	Alarm class	2	Class A, Class B, Class C, Class D, Class E, Class F , Control 2051: [Class B] 2057: [Class F]	Each limit may be assigned an independent alarm class that specifies what action should be taken when the limit is surpassed. Notes For additional information refer to ↗ “9.5.4 Alarm Classes”

ID	Parameter	CL	Setting range [Default]	Description
2052 2058	Self acknowledge	2	Yes	The control unit automatically clears the alarm if the fault condition is no longer detected.
		4	[No]	The control unit does not automatically reset the alarm when the fault condition is no longer detected. The alarm must be acknowledged and reset by manually pressing the appropriate buttons or by activating the LogicsManager output "External acknowledgment" (via a discrete input or via an interface).
2053 2059	Enabled	2	Always	Monitoring for this fault condition is continuously enabled.
		4	[87.70 LM:Eng.mon]	Monitoring for fault conditions is not performed until engine monitoring is enabled. This is determined through the LogicsManager equation "Release engine monitoring".
			For xx = 1 to 32: 96.{xx} LM: Flag{xx}	The monitoring is executed, if the LogicsManager "Flag {xx}" is TRUE. Example: 96.01 LM: Flag 1, 96.02 LM: Flag 2, ..., 96.32 LM: Flag 32

4.5.1.2.3 Generator Voltage Asymmetry

General notes

The voltage asymmetry monitors absolute value of all three phase-phase voltage difference: $dV_1=|V_{12}-V_{23}|$, $dV_2=|V_{23}-V_{31}|$ and $dV_3=|V_{31}-V_{12}|$. If one of measured dV_1 , dV_2 or dV_3 exceeds a configured permissible asymmetrical limit, an alarm is issued.

The percentage of permissible asymmetrical limit refers to the generator rated voltage.



If this protective function is triggered, the display indicates "Gen. volt. asymmetry" and the logical command variable "06.18" will be enabled.

Refer to "9.1.1 Triggering Characteristics" for the triggering characteristic of this monitoring function.



This monitoring function is only enabled if Generator voltage measuring (parameter 1851) is configured to "3Ph 4W" or "3Ph 3W".

4 Configuration

4.5.1.2.3 Generator Voltage Asymmetry

ID	Parameter	CL	Setting range [Default]	Description
3900	Monitoring	2	[On]	Voltage asymmetry monitoring is carried out according to the following parameters.
			Off	No monitoring is carried out.
3903	Limit	2	0.5 to 15.0% [10.0%] (Hysteresis: 0.5%) (Reset Delay: 80 ms)	The percentage values that are to be monitored for each threshold limit are defined here. If this value is reached or exceeded for at least the delay time without interruption, the action specified by the alarm class is initiated.
			Notes This value refers to the Generator rated voltage (parameter ↩ 1766).	
3904	Delay	2	0.02 to 99.99 s [5.00 s]	If the monitored generator voltage asymmetry exceeds the threshold value for the delay time configured here, an alarm will be issued.
			Notes If the monitored generator voltage asymmetry falls below the threshold (minus the hysteresis) before the delay expires the time will be reset	
3901	Alarm class	2	Class A, Class B, Class C, Class D, Class E, Class F , Control [Class F]	Each limit may be assigned an independent alarm class that specifies what action should be taken when the limit is surpassed.
			Notes For additional information refer to ↩ "9.5.4 Alarm Classes"	
3902	Self acknowledge	4	Yes	The control unit automatically clears the alarm if the fault condition is no longer detected.
			[No]	The control unit does not automatically reset the alarm when the fault condition is no longer detected. The alarm must be acknowledged and reset by manually pressing the appropriate buttons or by activating the LogicsManager output "External acknowledgment" (via a discrete input or via an interface).
3905	Enabled	2	Always	Monitoring for this fault condition is continuously enabled.
			[87.70 LM:Eng.mon]	Monitoring for fault conditions is not performed until engine monitoring is enabled. This is

ID	Parameter	CL	Setting range [Default]	Description
				determined through the LogicsManager equation "Release engine monitoring".
			For $xx = 1$ to 32 : 96.{xx} LM: Flag{xx}	The monitoring is executed, if the LogicsManager "Flag {xx}" is TRUE. Example: 96.01 LM: Flag 1, 96.02 LM: Flag 2, ..., 96.32 LM: Flag 32

4.5.1.3 Generator Frequency Monitoring

4.5.1.3.1 Plausibility Check of Voltages' AC Wiring

General Notes

The easYgen-3000XT detects the frequency out of up to six voltages (L1-N, L2-N, L3-N, L1-L2, L2-L3 and L3-L1). The frequency measurement (of all three systems) additionally checks the values on plausibility. With this monitoring the easYgen can detect wrong wiring issues.



Wrong Wiring Issue

It might occur that for example a generator frequency is measured even if the generator is not running. This can happen e.g. if PE (terminal 61) is not connected, the generator neutral connection is broken, and mains is energized with 1Ph2W connection. In this case a potential shift occurs which could lead to "ghostly" voltages at the generator (or busbar, or mains) phase-neutral system. This voltages lead to a frequency measurement even if no voltage is detected in the generator phase-phase system.

The »Plausibility AC wiring « monitoring is introduced to indicate such situations at generator, busbar, and mains measurement. These alarms are tripping if only "Phase-Phase" or only "Phase-Neutral" frequency is detected. If such an alarm ("Gen. AC wiring", "Busbar 1 AC wiring" or "Mains AC wiring" has tripped please check all "Phase-Phase" and "Phase-Neutral" voltages via HMI or ToolKit to get more information and check the AC wiring.



This »Plausibility AC wiring « monitoring function is only active if the wiring can provide "Phase-Phase" and "Phase-Neutral" values.

The plausibility monitoring offers one setting for all three measurement systems. The Monitor is placed under: [Parameter / Configuration / Configure monitoring / Miscellaneous / Other monitoring]. The alarm indications are called Gen. .../Busbar .../Mains AC wiring (see [↪ "9.5.5 Alarm Messages"](#)).

4 Configuration

4.5.1.3.2 Generator Overfrequency (Level 1 & 2) ANSI# 810

ID	Parameter	CL	Setting range [Default]	Description
1964	Monitoring	2	[On]	Enabling Plausibility AC Wiring monitoring.
			Off	Monitoring is disabled
1965	Delay	2	00.2 to 99.99 s [00.30]	If the monitored value undershoots the threshold value for the delay time configured here, an alarm will be issued.
1966	Alarm class	2	Class A, Class B, Class C, Class D, Class E, Class F , Control [Class B]	Each limit may be assigned an independent alarm class that specifies what action should be taken when the limit is surpassed.
1967	Self acknowledge	2	[Yes]	The control unit automatically clears the alarm if the fault condition is no longer detected.
			No	The control unit does not automatically reset the alarm when the fault condition is no longer detected.
1968	Enabled	2	[Always]	Monitoring for this fault condition is continuously enabled.
			87.70 LM:Eng.mon	Monitoring for fault conditions is not performed until engine monitoring is enabled. This is determined through the LogicsManager equation "Release engine monitoring".
			For xx = 1 to 32: 96.{xx} LM: Flag{xx}	The monitoring is executed, if the LogicsManager "Flag {xx}" is TRUE. Example: 96.01 LM: Flag 1, 96.02 LM: Flag 2, ..., 96.32 LM: Flag 32

4.5.1.3.2 Generator Overfrequency (Level 1 & 2) ANSI# 810

General notes

This controller provides the user with two alarm levels for generator overfrequency. Both alarms are definite time alarms.

Monitoring for overfrequency faults is performed in two steps.



If this protective function is triggered, the display indicates "Gen. overfrequency 1" or "Gen. overfrequency 2" and the logical command variable "06.01" or "06.02" will be enabled.

Refer to [9.1.1 Triggering Characteristics](#) for the triggering characteristic of this monitoring function. The diagrams listed there show a frequency trend and the associated pickup times and length of the alarms.



The parameter limits listed below have identical setting ranges. Each parameter may be configured with different settings to create unique trip characteristics for specific thresholds.

ID	Parameter	CL	Setting range [Default]	Description
1900 1906	Monitoring	2	[On]	Overfrequency monitoring is carried out according to the following parameters. Monitoring is performed at two levels. Both values may be configured independent from each other (prerequisite: Level 1 limit < limit 2).
			Off	Monitoring is disabled for Level 1 limit and/or Level 2 limit.
1904 1910	Limit	2	50.0 to 140.0% 1904: [110.0%] 1910: [115.0%] (Hysteresis: 0.05 Hz) (Reset Delay: 80 ms)	The percentage values that are to be monitored for each threshold limit are defined here. If this value is reached or exceeded for at least the delay time without interruption, the action specified by the alarm class is initiated.
				Notes This value refers to the System rated frequency (parameter 1750).
1905 1911	Delay	2	0.02 to 99.99 s 1905: [1.50 s] 1911: [0.30 s]	If the monitored generator frequency value exceeds the threshold value for the delay time configured here, an alarm will be issued.
				Notes If the monitored generator frequency falls below the threshold (minus the hysteresis) before the delay expires the time will be reset.
1901 1907	Alarm class	2	Class A, Class B, Class C, Class D, Class E, Class F , Control 1901: [Class B] 1907: [Class F]	Each limit may be assigned an independent alarm class that specifies what action should be taken when the limit is surpassed.
				Notes For additional information refer to "9.5.4 Alarm Classes"
1902 1908	Self acknowledge	2	Yes	The control unit automatically clears the alarm if the fault condition is no longer detected.
		4	[No]	The control unit does not automatically reset the alarm

4 Configuration

4.5.1.3.3 Generator Underfrequency (Level 1 & 2) ANSI# 810

ID	Parameter	CL	Setting range [Default]	Description
				when the fault condition is no longer detected. The alarm must be acknowledged and reset by manually pressing the appropriate buttons or by activating the LogicsManager output "External acknowledgment" (via a discrete input or via an interface).
1903 1909	Enabled	4	[Always]	Monitoring for this fault condition is continuously enabled.
			87.70 LM:Eng.mon	Monitoring for fault conditions is not performed until engine monitoring is enabled. This is determined through the LogicsManager equation "Release engine monitoring".
			For xx = 1 to 32: 96.{xx} LM: Flag{xx}	The monitoring is executed, if the LogicsManager "Flag {xx}" is TRUE. Example: 96.01 LM: Flag 1, 96.02 LM: Flag 2, ..., 96.32 LM: Flag 32

4.5.1.3.3 Generator Underfrequency (Level 1 & 2) ANSI# 810

General notes

This controller provides the user with two alarm levels for generator underfrequency. Both alarms are definite time alarms.

Monitoring for underfrequency faults is performed in two steps.



If this protective function is triggered, the display indicates "Gen. underfrequency 1" or "Gen. underfrequency 2" and the logical command variable "06.01" or "06.02" will be enabled.

Refer to [9.1.1 Triggering Characteristics](#) for the triggering characteristic of this monitoring function. The diagrams listed there show a frequency trend and the associated pickup times and length of the alarms.



The parameter limits listed below have identical setting ranges. Each parameter may be configured with different settings to create unique trip characteristics for specific thresholds.

ID	Parameter	CL	Setting range [Default]	Description
1950 1956	Monitoring	2	[On]	Underfrequency monitoring is carried out according to the following parameters. Monitoring

ID	Parameter	CL	Setting range [Default]	Description
				is performed at two levels. Both values may be configured independent from each other (prerequisite: Level 1 limit < limit 2).
			Off	Monitoring is disabled for Level 1 limit and/or Level 2 limit.
1954 1960	Limit	2	50.0 to 130.0% 1954: [90.0%] 1960: [84.0%] (Hysteresis: 0.05 Hz) (Reset Delay: 80 ms)	The percentage values that are to be monitored for each threshold limit are defined here. If this value is reached or lower for at least the delay time without interruption, the action specified by the alarm class is initiated. Notes This value refers to the System rated frequency (parameter ↩ 1750).
1955 1961	Delay	2	0.02 to 99.99 s 1955: [5.00 s] 1961: [0.30 s]	If the monitored generator frequency value falls below the threshold value for the delay time configured here, an alarm will be issued. Notes If the monitored generator frequency falls below the threshold (plus the hysteresis) before the delay expires the time will be reset.
1951 1957	Alarm class	2	Class A, Class B, Class C, Class D, Class E, Class F , Control 1951: [Class B] 1957: [Class F]	Each limit may be assigned an independent alarm class that specifies what action should be taken when the limit is surpassed. Notes For additional information refer to ↩ "9.5.4 Alarm Classes"
1952 1958	Self acknowledge	2 4	Yes [No]	The control unit automatically clears the alarm if the fault condition is no longer detected. The control unit does not automatically reset the alarm when the fault condition is no longer detected. The alarm must be acknowledged and reset by manually pressing the appropriate buttons or by activating the LogicsManager output "External acknowledgment" (via a discrete input or via an interface).

ID	Parameter	CL	Setting range [Default]	Description
1953	Enabled	2	Always	Monitoring for this fault condition is continuously enabled.
1959		4	[87.70 LM:Eng.mon]	Monitoring for fault conditions is not performed until engine monitoring is enabled. This is determined through the LogicsManager equation "Release engine monitoring".
			For xx = 1 to 32: 96.{xx} LM: Flag{xx}	The monitoring is executed, if the LogicsManager "Flag {xx}" is TRUE. Example: 96.01 LM: Flag 1, 96.02 LM: Flag 2, ..., 96.32 LM: Flag 32

4.5.1.4 Generator Current Monitoring

4.5.1.4.1 Generator Time-Overcurrent (Level 1, 2 & 3) ANSI# 50/51

General notes

Current is monitored according to how the parameter "Generator current measuring" (parameter [↩ 1850](#)) is configured. This controller provides the user with three definite time alarm levels for generator overcurrent faults.

Monitoring of the maximum phase current is performed in three steps. Every step can be provided with a delay time independent of the other steps.

If this protective function is triggered, the display indicates "Gen. overcurrent 1", "Gen. overcurrent 2", or "Gen. overcurrent 3" and the logical command variable "06.09", "06.10.", or "06.11" will be enabled.

Refer to [↩ 9.1.1 Triggering Characteristics](#) for the triggering characteristic of this monitoring function.

ID	Parameter	CL	Setting range [Default]	Description
2200	Monitoring	2	[On]	Overcurrent monitoring is carried out according to the following parameters. Monitoring is performed at three levels. All three values may be configured independent from each other (prerequisite: Level 1 < Level 2 < Level 3).
2206				
2212			Off	Monitoring is disabled for Level 1 limit, Level 2 limit, and/or Level 3 limit.

ID	Parameter	CL	Setting range [Default]	Description
2204 2210 2216	Limit	2	50.0 to 300.0% 2204: [110.0%] 2210: [150.0%] 2216: [250.0%] (Hysteresis: 1%) (Reset Delay: 1 s)	<p>The percentage values that are to be monitored for each threshold limit are defined here.</p> <p>If this value is reached or exceeded for at least the delay time without interruption, the action specified by the alarm class is initiated.</p> <p>Notes</p> <p>This value refers to the Generator rated current (parameter 1754).</p>
2205 2211 2217	Delay	2	0.02 to 99.99 s 2205: [30.00 s] 2211: [1.00 s] 2217: [0.40 s]	<p>If the monitored generator current exceeds the threshold value for the delay time configured here, an alarm will be issued.</p> <p>Notes</p> <p>If the monitored generator current falls below the threshold (minus the hysteresis) before the delay expires the time will be reset.</p>
2224 2225 2226	Voltage restraint monitoring	4	Yes	<p>The control provides voltage restrained overcurrent relay according to ANSI 51 V individually for each generator current monitoring function.</p> <p>For details refer to 4.5.1.4.3 Generator Voltage Restrained Overcurrent Monitoring - ANSI #51V.</p>
			[No]	Voltage restrained monitoring is disabled.
2201 2207 2213	Alarm class	2	Class A, Class B, Class C, Class D, Class E, Class F , Control 2201: [Class E] 2207: [Class F] 2213: [Class F]	<p>Each limit may be assigned an independent alarm class that specifies what action should be taken when the limit is surpassed.</p> <p>Notes</p> <p>For additional information refer to 9.5.4 Alarm Classes</p>
2202 2208 2214	Self acknowledge	2 4 4	Yes	<p>The control unit automatically clears the alarm if the fault condition is no longer detected.</p>
			[No]	<p>The control unit does not automatically reset the alarm when the fault condition is no longer detected.</p> <p>The alarm must be acknowledged and reset by manually pressing the appropriate buttons or by activating the LogicsManager output "External acknowledgment" (via a discrete input or via an interface).</p>

ID	Parameter	CL	Setting range [Default]	Description
2203	Enabled	4	[Always]	Monitoring for this fault condition is continuously enabled.
2209			87.70 LM:Eng.mon	Monitoring for fault conditions is not performed until engine monitoring is enabled. This is determined through the LogicsManager equation "Release engine monitoring".
2215			For xx = 1 to 32: 96.{xx} LM: Flag{xx}	The monitoring is executed, if the LogicsManager "Flag {xx}" is TRUE. Example: 96.01 LM: Flag 1, 96.02 LM: Flag 2, ..., 96.32 LM: Flag 32

4.5.1.4.2 Generator Inverse Time-Overcurrent ANSI# IEC 255

General notes

The current produced by the generator is monitored depending on how parameter "Generator current measuring" (parameter [1850](#)) is configured. If an overcurrent condition is detected, the fault recognition time is determined by the configured tripping characteristic curve and the measured current.

The tripping time is faster as the measured current increases in magnitude according to a defined curve. According to IEC 255 three different characteristics are available.

If this protective function is triggered, the display indicates "Inv. time overcurr." and the logical command variable "06.22" will be enabled.

- "Normal inverse" characteristic:
$$t = 0.14 / (I/I_p)^{0.02} - 1) * t_p[s]$$
- "Highly inverse" characteristic:
$$t = 13.5 / (I/I_p) - 1) * t_p[s]$$
- "Extremely inverse" characteristic:
$$t = 80 / (I/I_p)^2 - 1) * t_p[s]$$

Variables:

- t = tripping time
- t_p = setting value time
- I = measured fault current
- I_p = setting value current

Please take into account during configuration:

- for I_{start} :
 $I_{start} > I_n$ and $I_{start} > I_p$
- for I_p the smaller I_p is, the steeper is the slope of the tripping curve



The maximum tripping time is 327 s. If a tripping time greater than 327 s is configured, an overcurrent fault condition will not be recognized.

Characteristics

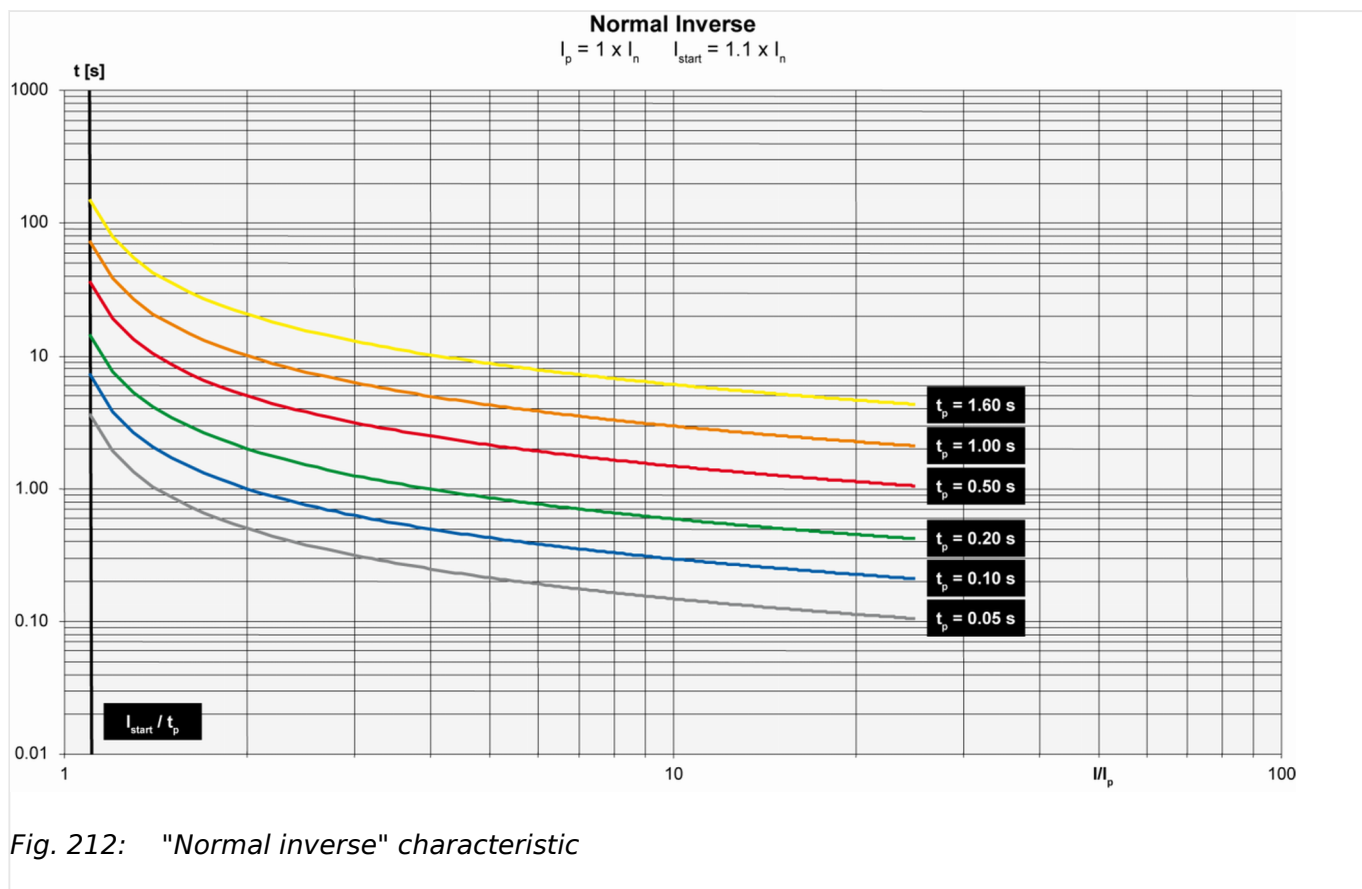

Fig. 212: "Normal inverse" characteristic

4 Configuration

4.5.1.4.2 Generator Inverse Time-Overcurrent ANSI# IEC 255

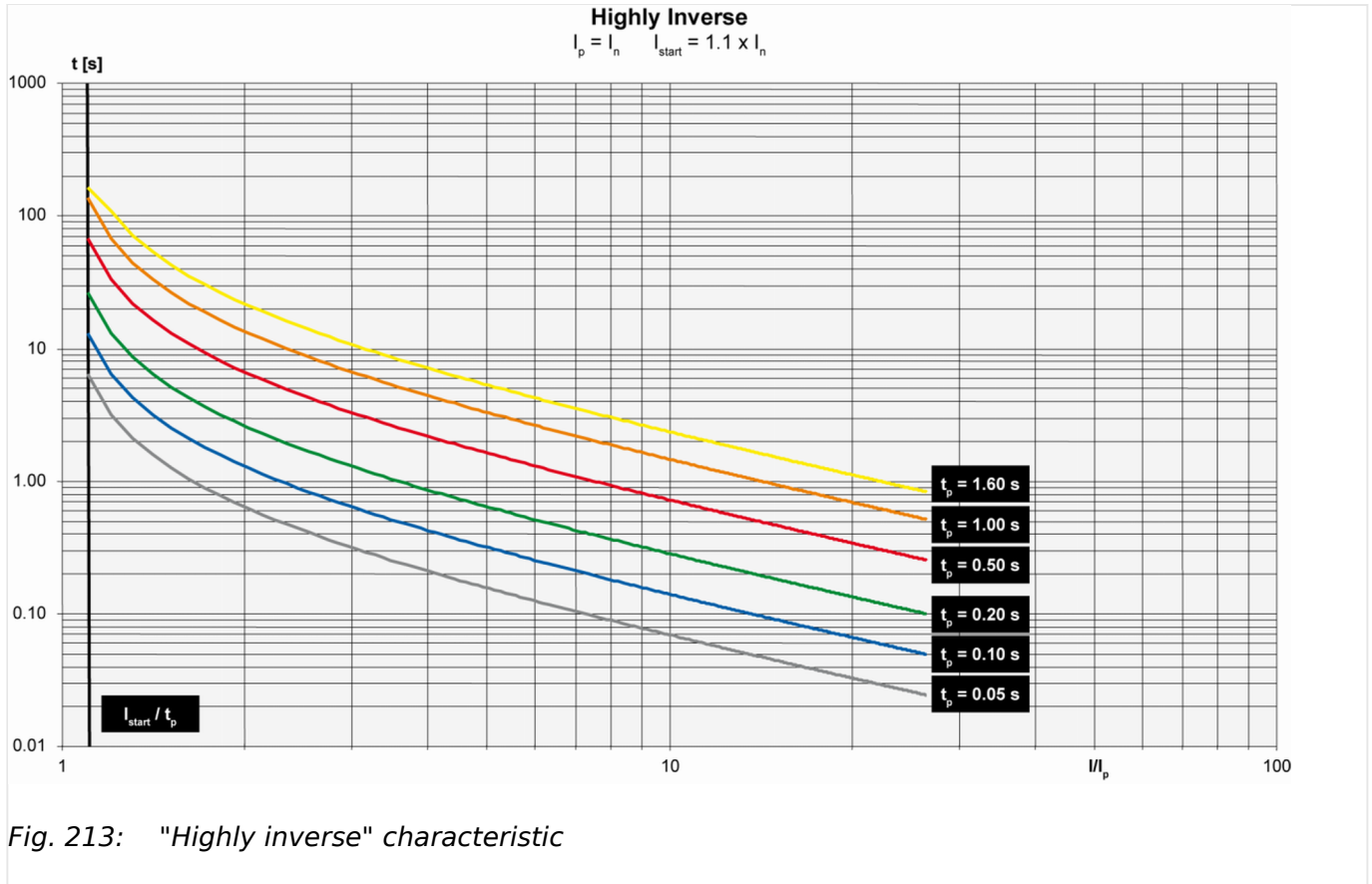

Fig. 213: "Highly inverse" characteristic

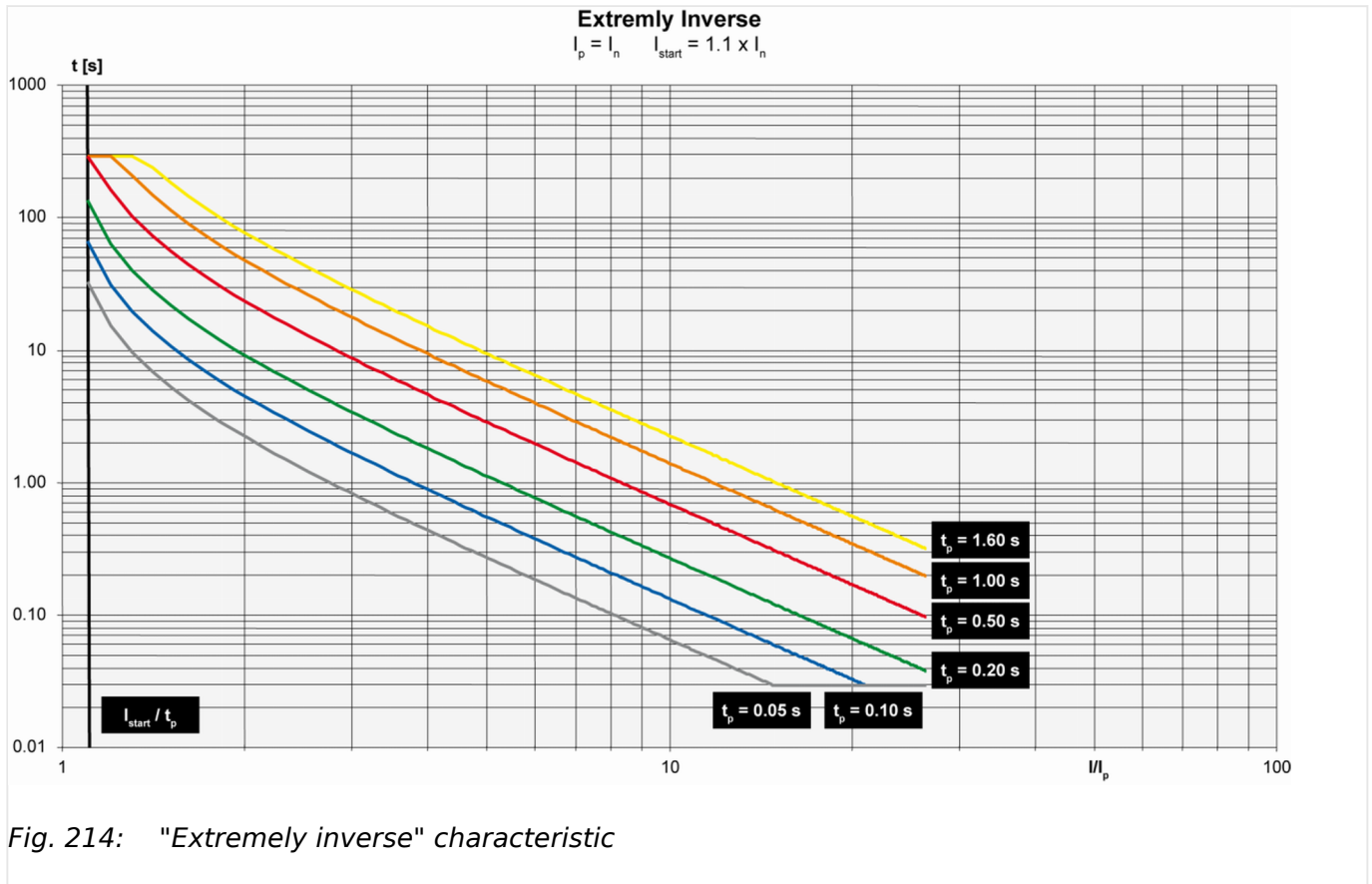

Fig. 214: "Extremely inverse" characteristic

ID	Parameter	CL	Setting range [Default]	Description
4030	Monitoring	2	[On]	Overcurrent monitoring is carried out according to the following parameters.
			Off	No monitoring is carried out.
4034	Inverse time characteristic	2		Selection of the used overcurrent characteristic.
			[Normal]	The "normal inverse" tripping curve will be used
			Strong	The "highly inverse" tripping curve will be used
			Extreme	The "extremely inverse" tripping curve will be used.
4035	Inverse time overcurrent Tp=	2	0.01 to 5.00 s [0.06 s]	Time constant T_p used to calculate the characteristics.
4036	Inverse time overcurr. Ip=	2	10.0 to 300.0% [100.0%]	Current constant I_p used to calculate the characteristics.
4037	Inv. time overcurr. I-start=	2	100.0 to 300.0% [115.0%] (Hysteresis: 1%) (Reset Delay: 1 s)	Lower tripping value for inverse time-overcurrent protection. If the monitored current is less than I_{start} , the inverse time-overcurrent protection does not trip. If I_{start} is less than I_p , I_p is used as the lower tripping value.
2227	Voltage restraint monitoring	4	Yes	The control provides voltage restrained inverse time overcurrent monitoring. For general information about voltage restrained monitoring refer to ↳ "4.5.1.4.3 Generator Voltage Restrained Overcurrent Monitoring - ANSI #51V" .
			[No]	Voltage restrained monitoring is disabled.
4031	Alarm class	2	Class A, Class B, Class C, Class D, Class E, Class F , Control [Class F]	Each limit may be assigned an independent alarm class that specifies what action should be taken when the limit is surpassed. Notes For additional information refer to ↳ "9.5.4 Alarm Classes"
4032	Self acknowledge	2	Yes	The control unit automatically clears the alarm if the fault condition is no longer detected.
			[No]	The control unit does not automatically reset the alarm when the fault condition is no longer detected. The alarm must be acknowledged and reset by manually pressing the appropriate buttons or by

4 Configuration

4.5.1.4.3 Generator Voltage Restrained Overcurrent Monitoring - ANSI #51V

ID	Parameter	CL	Setting range [Default]	Description
				activating the LogicsManager output "External acknowledgment" (via a discrete input or via an interface).
4033	Enabled	2	[Always]	Monitoring for this fault condition is continuously enabled.
			87.70 LM:Eng.mon	Monitoring for fault conditions is not performed until engine monitoring is enabled. This is determined through the LogicsManager equation "Release engine monitoring".
			For $xx = 1$ to 32: 96.{xx} LM: Flag{xx}	The monitoring is executed, if the LogicsManager "Flag {xx}" is TRUE. Example: 96.01 LM: Flag 1, 96.02 LM: Flag 2, ..., 96.32 LM: Flag 32

4.5.1.4.3 Generator Voltage Restrained Overcurrent Monitoring - ANSI #51V

General Notes

This function is an add-on to the over current monitoring and decreases the activation limit dependent on the amount of voltage dip. Especially in near to generator located over currents it can lead to situations, where the failure current remains under the generator rated current. In this case a normal over current monitoring does not trip. The voltage restraint over current monitoring considers this and decreases the configured over current limit according to a modification factor, that it comes to a trip.

The considered voltages are either the single phase-phase or phase-neutral voltages. (Refer to "Generator voltage monitoring" [↪ 1770](#)). The monitor takes always the lowest considered voltage into account for calculating the modification factor.

Voltage restraint over current monitoring can be activated individually for "Generator over current (limit 1-3)" and Generator inverse time over current, if the according parameter 2227 "Voltage restraint monitoring" is switched to "Yes".

The modification factor depends on the measured voltage in percent of rated voltage. It is defined by a characteristic which is defined by three parameters (ID 2230, 2231, 2232 cf. figure). This characteristic is taken into account for all over current monitoring functions, if enabled.

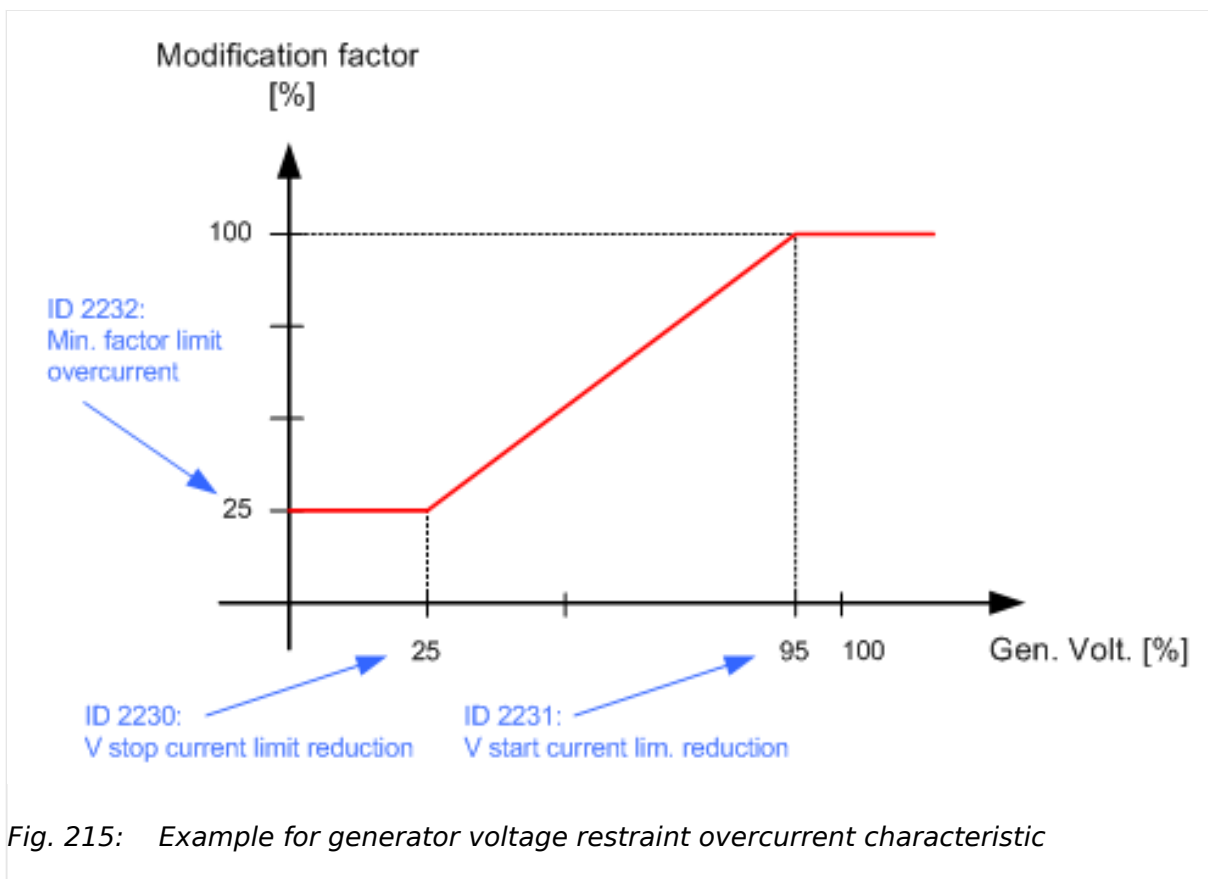

Fig. 215: Example for generator voltage restraint overcurrent characteristic

Beginning at a voltage dip of 95% rated voltage (configured by 2231), the modification factor will be linearly reduced (cf. figure 86). If the voltage reaches 25% or less (configured by 2230) the modification factor will remain at 25% (configured by 2232).

Now the effective limit is calculated as:

$$\text{Effective limit [\%]} = \text{Limit [\%]} * \text{Modification Factor [\%]} / 100[\%]$$

Supposed the configured limit of an over current monitor is 110% and the measured voltage is 25%:

$$\text{Effective limit [\%]} = 110\% * 25\% / 100\% = 27.5\%$$



The V (voltage) start value configuration must be entered higher as the V stop value configuration. Otherwise the function does not work properly!

ID	Parameter	CL	Setting range [Default]	Description
2231	V start current lim. reduction	2	5.0 ... 100.0% [95.0%]	Voltage for starting current limitation reduction
2230	V stop current limit reduction	2	5.0 ... 100.0% [25.0%]	Voltage for stopping current limitation reduction

ID	Parameter	CL	Setting range [Default]	Description
2232	Min.factor limit overcurrent	2	5.0 ... 100.0% [25.0%]	Minimum factor limit for current limitation reduction

4.5.1.5 Generator Power Monitoring

4.5.1.5.1 Generator Overload IOP (Level 1 & 2) ANSI# 32

General notes



IOP = islanded Operation in Parallel

The power produced by the generator is calculated from the voltage and current values measured in accordance with how parameters "Generator voltage measuring" (parameter [↩➤ 1851](#)) and "Generator current measuring" (parameter [↩➤ 1850](#)) are configured. The controller monitors if the system is in a mains parallel or an islanded operation.

When the controller detects that the system is operating islanded from the mains, the Generator Overload MOP (refer to [↩➤ "4.5.1.5.2 Generator Overload MOP \(Level 1 & 2\) ANSI# 32"](#)) monitoring is disabled. If the measured generator real power during an islanded operation is above the configured limit an alarm will be issued.



If this protective function is triggered, the display indicates "Gen. Overload IOP 1" or "Gen. Overload IOP 2" and the logical command variable "06.14" or "06.15" will be enabled.

Refer to [↩➤ "9.1.1 Triggering Characteristics"](#) for the triggering characteristic of this monitoring function.

ID	Parameter	CL	Setting range [Default]	Description
2300 2306	Monitoring	2	[On]	Overload monitoring is carried out according to the following parameters. Monitoring is performed at two levels. Both values may be configured independent from each other (prerequisite: Level 1 limit < Level 2 limit).
			Off	Monitoring is disabled for Level 1 limit and/or Level 2 limit.
2304 2310	Limit	2	50.0 to 300.0% 2304: [110.0%] 2310: [120.0%]	The percentage values that are to be monitored for each threshold limit are defined here.

ID	Parameter	CL	Setting range [Default]	Description
			(Hysteresis: 1%) (Reset Delay: 80 ms)	If this value is reached or exceeded for at least the delay time without interruption, the action specified by the alarm class is initiated. Notes This value refers to the Generator rated active power (parameter 1752).
2305 2311	Delay	2	0.02 to 99.99 s 2305: [11.00 s] 2311: [0.10 s]	If the monitored generator load exceeds the threshold value for the delay time configured here, an alarm will be issued. Notes If the monitored generator load falls below the threshold (minus the hysteresis) before the delay expires the time will be reset.
2301 2307	Alarm class	2	Class A, Class B, Class C, Class D, Class E, Class F , Control 2301: [Class B] 2307: [Class D]	Each limit may be assigned an independent alarm class that specifies what action should be taken when the limit is surpassed. Notes For additional information refer to "9.5.4 Alarm Classes"
2302 2308	Self acknowledge	2 4	Yes [No]	The control automatically clears the alarm if the fault condition is no longer detected. The control does not automatically reset the alarm when the fault condition is no longer detected. The alarm must be acknowledged and reset by manually pressing the appropriate buttons or by activating the LogicsManager output "External acknowledgment" (via a discrete input or via an interface).
2303 2309	Enabled	2	[Always] 87.70 LM:Eng.mon <i>For xx = 1 to 32:</i> 96.{xx} LM: Flag{xx}	Monitoring for this fault condition is continuously enabled. Monitoring for fault conditions is not performed until engine monitoring is enabled. This is determined through the LogicsManager equation "Release engine monitoring". The monitoring is executed, if the LogicsManager "Flag {xx}" is TRUE. Example:

4 Configuration

4.5.1.5.2 Generator Overload MOP (Level 1 & 2) ANSI# 32

ID	Parameter	CL	Setting range [Default]	Description
				96.01 LM: Flag 1, 96.02 LM: Flag 2, ..., 96.32 LM: Flag 32

4.5.1.5.2 Generator Overload MOP (Level 1 & 2) ANSI# 32

General notes



MOP = Mains Parallel Operation

The power produced by the generator is calculated from the voltage and current values measured in accordance with how parameters "Generator voltage measuring" (parameter [↪ 1851](#)) and "Generator current measuring" (parameter [↪ 1850](#)) are configured.

The controller monitors if the system is in a mains parallel or an islanded operation. When the controller detects that the system is operating parallel with the mains, the Generator Overload IOP (refer to [↪ "4.5.1.5.1 Generator Overload IOP \(Level 1 & 2\) ANSI# 32"](#)) monitoring is disabled. If the measured generator real power during a mains parallel operation is above the configured limit an alarm will be issued.



If this protective function is triggered, the display indicates "Gen. Overload MOP 1" or "Gen. Overload MOP 2" and the logical command variable "06.23" or "06.24" will be enabled.

Refer to [↪ "9.1.1 Triggering Characteristics"](#) for the triggering characteristic of this monitoring function.

ID	Parameter	CL	Setting range [Default]	Description
2350 2356	Monitoring	2	[On]	Overload monitoring is carried out according to the following parameters. Monitoring is performed at two levels. Both values may be configured independent from each other (prerequisite: Level 1 limit < Level 2 limit).
			Off	Monitoring is disabled for Level 1 limit and/or Level 2 limit.
2354 2360	Limit	2	50.0 to 300.0% 2354: [105.0%] 2360: [110.0%] (Hysteresis: 1%) (Reset Delay: 80 ms)	The percentage values that are to be monitored for each threshold limit are defined here. If this value is reached or exceeded for at least the delay time without interruption, the action specified by the alarm class is initiated.

ID	Parameter	CL	Setting range [Default]	Description
				<p>Notes</p> <p>This value refers to the Generator rated active power (parameter ↩> 1752).</p>
2355 2361	Delay	2	0.02 to 99.99 s 2355: [5.00 s] 2361: [0.10 s]	<p>If the monitored generator load exceeds the threshold value for the delay time configured here, an alarm will be issued.</p> <p>Notes</p> <p>If the monitored generator load falls below the threshold (minus the hysteresis) before the delay expires the time will be reset.</p>
2351 2357	Alarm class	2	Class A, Class B, Class C, Class D, Class E, Class F , Control 2351: [Class B] 2357: [Class D]	<p>Each limit may be assigned an independent alarm class that specifies what action should be taken when the limit is surpassed.</p> <p>Notes</p> <p>For additional information refer to ↩> "9.5.4 Alarm Classes"</p>
2352 2358	Self acknowledge	4	Yes [No]	<p>The control automatically clears the alarm if the fault condition is no longer detected.</p> <p>The control does not automatically reset the alarm when the fault condition is no longer detected.</p> <p>The alarm must be acknowledged and reset by manually pressing the appropriate buttons or by activating the LogicsManager output "External acknowledgment" (via a discrete input or via an interface).</p>
2353 2359	Enabled	2	[Always] 87.70 LM:Eng.mon <i>For xx = 1 to 32:</i> 96.{xx} LM: Flag{xx}	<p>Monitoring for this fault condition is continuously enabled.</p> <p>Monitoring for fault conditions is not performed until engine monitoring is enabled. This is determined through the LogicsManager equation "Release engine monitoring".</p> <p>The monitoring is executed, if the LogicsManager "Flag {xx}" is TRUE.</p> <p>Example:</p> <p>96.01 LM: Flag 1, 96.02 LM: Flag 2, ..., 96.32 LM: Flag 32</p>

4.5.1.5.3 Generator Reverse/Reduced Power (Level 1 & 2) ANSI# 32R/F

General notes

The power produced by the generator is calculated from the voltage and current values measured in accordance with how parameters "Generator voltage measuring" (parameter ↩➤ 1851) and "Generator current measuring" (parameter ↩➤ 1850) are configured.

The generator power limits may be configured for reduced power and/or reverse power depending on the threshold values entered. The note below explains how a reduced or reverse power limit is configured.

If the single-phase or three-phase measured real power is below the configured limit of the reduced load or below the configured value of the reverse power, an alarm will be issued.



If this protective function is triggered, the display indicates "Gen. rev./red. pwr.1" or "Gen. rev./red. pwr.2" and the logical command variable "06.12" or "06.13" will be enabled.

Refer to ↩➤ "9.1.1 Triggering Characteristics" for the triggering characteristic of this monitoring function.



Definition

- Reduced power Fault initiated if the monitored real power falls below the configured (positive) limit.
- Reverse power Fault initiated if the direction of the monitored real power reverses and the configured (negative) limit is exceeded.

Configuration examples

The values for reverse /reduced power monitoring can be configured as follows:

- Level 1 limit = Positive and Level 2 limit = Positive
(whereas Level 1 limit > Level 2 limit > 0 %)
- Both limits are configured for reduced power monitoring.



Example

- Rated power is 100 kW, Level 1 limit = 5 % > Level 2 limit = 3 %
- Tripping if real power falls below 5 kW (Level 1 limit) or 3 kW (Level 2 limit)
- Level 1 limit = Negative and Level 2 limit = Negative
(whereas Level 2 limit < Level 1 limit < 0%)
Both limits are configured for reverse power monitoring.

*

Example

- Rated power is 100 kW, Level 1 limit = -3 % > Level 2 limit = -5 %
- Tripping if real power falls below -3 kW (Level 1 limit) or -5 kW (Level 2 limit)
- Level 1 limit = Positive and Level 2 limit = Negative
(whereas Level 1 limit > 0 % > Level 2 limit)
- Level 1 is configured for reduced power monitoring and
- Level 2 is configured for reverse power monitoring.

*

Example

- Rated power is 100 kW, Level 1 limit = 3 % > Level 2 limit = -5 %
- Tripping if real power falls below 3 kW (Level 1 limit) or -5 kW (Level 2 limit)

ID	Parameter	CL	Setting range [Default]	Description
2250 2256	Monitoring	2	[On]	Reverse/reduced power monitoring is carried out according to the following parameters. Both values may be configured independent from each other.
			Off	Monitoring is disabled for Level 1 limit and/or Level 2 limit.
2254 2260	Limit	2	-99.9 to 99.9% 2254: [-3.0%] 2260: [-5.0%] (Hysteresis: 1%) (Reset Delay: 80 ms)	The percentage values that are to be monitored for each threshold limit are defined here. If this value is reached or fallen below for at least the delay time without interruption, the action specified by the alarm class is initiated.
			Notes This value refers to the Generator rated active power (parameter ↩ 1752).	
2255 2261	Delay	2	0.02 to 99.99 s 2255: [5.00 s] 2261: [5.00 s]	If the monitored generator power falls below the threshold value for the delay time configured here, an alarm will be issued.
			Notes If the monitored generator power exceeds or falls below the threshold (plus/minus the hysteresis) again before the delay expires the time will be reset.	

4 Configuration

4.5.1.5.4 Generator Unbalanced Load (Level 1 & 2) ANSI# 46

ID	Parameter	CL	Setting range [Default]	Description
2251 2257	Alarm class	2	Class A, Class B, Class C, Class D, Class E, Class F , Control 2251: [Class B] 2257: [Class F]	Each limit may be assigned an independent alarm class that specifies what action should be taken when the limit is surpassed. Notes For additional information refer to "9.5.4 Alarm Classes"
2252 2258		4	[No]	The control unit automatically clears the alarm if the fault condition is no longer detected. The control unit does not automatically reset the alarm when the fault condition is no longer detected. The alarm must be acknowledged and reset by manually pressing the appropriate buttons or by activating the LogicsManager output "External acknowledgment" (via a discrete input or via an interface).
2253 2259	Enabled	2	[Always]	Monitoring for this fault condition is continuously enabled.
			87.70 LM:Eng.mon	Monitoring for fault conditions is not performed until engine monitoring is enabled. This is determined through the LogicsManager equation "Release engine monitoring".
			For xx = 1 to 32: 96.{xx} LM: Flag{xx}	The monitoring is executed, if the LogicsManager "Flag {xx}" is TRUE. Example: 96.01 LM: Flag 1, 96.02 LM: Flag 2, ..., 96.32 LM: Flag 32

4.5.1.5.4 Generator Unbalanced Load (Level 1 & 2) ANSI# 46

General notes

Unbalanced load is monitored according to how the parameters "Generator voltage measuring" (parameter [1851](#)) and "Generator current measuring" (parameter [1850](#)) are configured. The unbalanced load alarm monitors the individual phase currents of the generator. The percentage threshold value is the permissible variation of one phase from the average measured current of all three phases.



If this protective function is triggered, the display indicates "Unbalanced load 1" or "Unbalanced load 2" and the logical command variable "06.16" or "06.17" will be enabled.

Refer to [9.1.1 Triggering Characteristics](#) for the triggering characteristic of this monitoring function.



This monitoring function is only enabled when Generator voltage measuring (parameter [1851](#)) is configured to "3Ph 4W", "3Ph 4W OD", or "3Ph 3W" and Generator current measuring (parameter [1850](#)) is configured to "L1 L2 L3".

Formulas

	Phase L1	Phase L2	Phase L3
Exceeding	$I_{L1} \geq (3 * I_N * P_A + I_{L2} + I_{L3}) / 2$	$I_{L2} \geq (3 * I_N * P_A + I_{L1} + I_{L3}) / 2$	$I_{L3} \geq (3 * I_N * P_A + I_{L1} + I_{L2}) / 2$
Falling below	$I_{L1} \leq (I_{L2} + I_{L3} - 3 * I_N * P_A) / 2$	$I_{L2} \leq (I_{L1} + I_{L3} - 3 * I_N * P_A) / 2$	$I_{L3} \leq (I_{L1} + I_{L2} - 3 * I_N * P_A) / 2$

Examples

* Exceeding a limit value

- Current in phase L1 = current in phase L3
- Current in phase L2 has been exceeded
- P_A = tripping value percentage (example 10 %)
- I_N = rated current (example 300 A)

Tripping value for phase L2:

- $I_{L2} \geq (3 * I_N * P_A + I_{L1} + I_{L3}) / 2$
 $= (3 * 300 \text{ A} * 10\% + 300 \text{ A} + 300 \text{ A}) / 2$
 $= ((3 * 300 \text{ A} * 10) / 100 + 300 \text{ A} + 300 \text{ A}) / 2$
 $= 345 \text{ A}$

* Falling below a limit value

- Current in phase L2 = current in phase L3
- Current in phase L1 has been undershot
- P_A = tripping value percentage (example 10 %)
- I_N = rated current (example 300 A)

Tripping value for phase L1:

- $I_{L1} \leq (I_{L2} + I_{L3} - 3 * I_N * P_A) / 2$
 $= (300 \text{ A} + 300 \text{ A} - 3 * 300 \text{ A} * 10\%) / 2$
 $= (300 \text{ A} + 300 \text{ A} - (3 * 300 \text{ A} * 10) / 100) / 2$
 $= 255 \text{ A}$

ID	Parameter	CL	Setting range [Default]	Description
2400	Monitoring	2	[On]	Unbalanced load monitoring is carried out according to the

4 Configuration

4.5.1.5.4 Generator Unbalanced Load (Level 1 & 2) ANSI# 46

ID	Parameter	CL	Setting range [Default]	Description
2406				<p>following parameters. Monitoring is performed at two levels.</p> <p>Both values may be configured independent from each other (condition: Level 1 < Level 2).</p>
			Off	No monitoring is carried out for either Level 1 limit or Level 2 limit.
2404 2410	Limit	2	0.0 to 100.0% 2404: [10.0%] 2410: [15.0%] (Hysteresis: 0.5%) (Reset Delay: 80 ms)	<p>The percentage values that are to be monitored for each threshold limit are defined here.</p> <p>If this value is reached or exceeded for at least the delay time without interruption, the action specified by the alarm class is initiated.</p> <p>Notes</p> <p>This value refers to the "Generator rated current" (parameter ↩➤ 1754)</p>
2405 2411	Delay	2	0.02 to 99.99 s 2405: [5.00 s] 2411: [1.00 s]	<p>If the monitored current exceeds the threshold value for the delay time configured here, an alarm will be issued.</p> <p>Notes</p> <p>If the monitored current falls below the threshold (minus the hysteresis) before the delay expires the time will be reset.</p>
2401 2407	Alarm class	2	Class A, Class B, Class C, Class D, Class E, Class F , Control 2401: [Class B] 2407: [Class E]	<p>Each limit may be assigned an independent alarm class that specifies what action should be taken when the limit is surpassed.</p> <p>Notes</p> <p>For additional information refer to ↩➤ "9.5.4 Alarm Classes"</p>
2402 2408	Self acknowledge	2 4	Yes [No]	<p>The control unit automatically clears the alarm if the fault condition is no longer detected.</p> <p>The control unit does not automatically reset the alarm when the fault condition is no longer detected.</p> <p>The alarm must be acknowledged and reset by manually pressing the appropriate buttons or by activating the LogicsManager output "External acknowledgment" (via a discrete input or via an interface).</p>
2403	Enabled	2	[Always]	Monitoring for this fault condition is continuously enabled.

ID	Parameter	CL	Setting range [Default]	Description
2409			87.70 LM:Eng.mon	Monitoring for fault conditions is not performed until engine monitoring is enabled. This is determined through the LogicsManager equation "Release engine monitoring".
			For xx = 1 to 32: 96.{xx} LM: Flag{xx}	The monitoring is executed, if the LogicsManager "Flag {xx}" is TRUE. Example: 96.01 LM: Flag 1, 96.02 LM: Flag 2, ..., 96.32 LM: Flag 32

4.5.1.5.5 Load sharing

Active power load sharing mismatch

ID	Parameter	CL	Setting range [Default]	Description
5100	Monitoring	2	On	Load share monitoring is carried out according to the following parameters.
			[Off]	Monitoring is disabled.
4841	Limit	2	1.0 to 100.0% [30.0%]	The percentage value that is to be monitored for the threshold limit is defined here. If this value is reached or exceeded for at least the delay time without interruption, the action specified by the alarm class is initiated.
			Notes This value is rated to the absolute difference between generator rated power (parameter 1752) and the percent average power of the other devices. The generator rated power is modified by the derating factor if derating is activated.	
5104	Delay	2	1.0 to 999.9 s [10.0 s]	If the monitored generator power value exceeds the threshold value for the delay time configured here, an alarm will be issued.
			Notes If the monitored generator power falls below the threshold (minus the hysteresis) before the delay expires the time will be reset.	
5101	Alarm class	2	Class A, Class B, Class C, Class D, Class E, Class F , Control	Each limit may be assigned an independent alarm class that

ID	Parameter	CL	Setting range [Default]	Description
			[Class B]	specifies what action should be taken when the limit is surpassed. Notes For additional information refer to "9.5.4 Alarm Classes"
5102	Self acknowledge	2	Yes	The control unit automatically clears the alarm if the fault condition is no longer detected.
			[No]	The control unit does not automatically reset the alarm when the fault condition is no longer detected. The alarm must be acknowledged and reset by manually pressing the appropriate buttons or by activating the LogicsManager output "External acknowledgment" (via a discrete input or via an interface).
5103	Enabled	2	[Always]	Monitoring for this fault condition is continuously enabled.
			87.70 LM:Eng.mon	Monitoring for fault conditions is not performed until engine monitoring is enabled. This is determined through the LogicsManager equation "Release engine monitoring".
			For $xx = 1$ to 32 : 96.{xx} LM: Flag{xx}	The monitoring is executed, if the LogicsManager "Flag {xx}" is TRUE. Example: 96.01 LM: Flag 1, 96.02 LM: Flag 2, ..., 96.32 LM: Flag 32

Reactive power load sharing mismatch

ID	Parameter	CL	Setting range [Default]	Description
5106	Monitoring	2	On	Load share monitoring is carried out according to the following parameters.
			[Off]	Monitoring is disabled.
4842	Limit	2	1.0 to 100.0% [30.0%]	The percentage value that is to be monitored for the threshold limit is defined here. If this value is reached or exceeded for at least the delay time without interruption, the action specified by the alarm class is initiated. Notes

ID	Parameter	CL	Setting range [Default]	Description
				This value is rated to the absolute difference between generator rated reactive power (parameter 1758) and the percent average reactive power of the other devices. The generator rated reactive power is modified by the derating factor if derating is activated.
5110	Delay	2	1.0 to 999.9 s [10.0 s]	<p>If the monitored generator power value exceeds the threshold value for the delay time configured here, an alarm will be issued.</p> <p>Notes</p> <p>If the monitored generator power falls below the threshold (minus the hysteresis) before the delay expires the time will be reset.</p>
5107	Alarm class	2	Class A, Class B, Class C, Class D, Class E, Class F , Control [Class B]	<p>Each limit may be assigned an independent alarm class that specifies what action should be taken when the limit is surpassed.</p> <p>Notes</p> <p>For additional information refer to "9.5.4 Alarm Classes"</p>
5108	Self acknowledge	2	Yes [No]	<p>The control unit automatically clears the alarm if the fault condition is no longer detected.</p> <p>The control unit does not automatically reset the alarm when the fault condition is no longer detected.</p> <p>The alarm must be acknowledged and reset by manually pressing the appropriate buttons or by activating the LogicsManager output "External acknowledgment" (via a discrete input or via an interface).</p>
5109	Enabled	2	<p>[Always]</p> <p>87.70 LM:Eng.mon</p> <p>For xx = 1 to 32: 96.{xx} LM: Flag{xx}</p>	<p>Monitoring for this fault condition is continuously enabled.</p> <p>Monitoring for fault conditions is not performed until engine monitoring is enabled. This is determined through the LogicsManager equation "Release engine monitoring".</p> <p>The monitoring is executed, if the LogicsManager "Flag {xx}" is TRUE.</p> <p>Example:</p>

4 Configuration

4.5.1.5.6 Engine/Generator Active Power Mismatch

ID	Parameter	CL	Setting range [Default]	Description
				96.01 LM: Flag 1, 96.02 LM: Flag 2, ..., 96.32 LM: Flag 32

4.5.1.5.6 Engine/Generator Active Power Mismatch

General notes

If enabled, this monitoring function becomes only active if generator power control is enabled (refer to [4.4.4.5 Load Control](#)). If the measured generator power deviates from the power setpoint by a value exceeding the limit configured in parameter [2925](#) for a time exceeding the delay configured in parameter [2923](#), an alarm will be issued.



If this protective function is triggered, the display indicates "Gen act.pwr mismatch" and the logical command variable "06.29" will be enabled.

ID	Parameter	CL	Setting range [Default]	Description
2920	Monitoring	2	[On]	Monitoring of the generator active power mismatch is carried out according to the following parameters.
			Off	Monitoring is disabled.
2925	Limit	2	1.0 to 30.0% [5.0%]	If the difference between the measured generator power and the power setpoint exceeds this value for at least the delay time (parameter 2923) without interruption, the action specified by the alarm class is initiated.
				Notes This value refers to the generator rated active power (parameter 1752).
2923	Delay	2	3 to 9999 s [30 s]	If the monitored active power mismatch exceeds the threshold value configured in parameter 2925 for the delay time configured here, an alarm will be issued.
				Notes If the monitored active power mismatch falls below the threshold (minus the hysteresis) before the delay expires the time will be reset.
2921	Alarm class	2	Class A, Class B, Class C, Class D, Class E, Class F , Control	Each limit may be assigned an independent alarm class that specifies what action should be taken when the limit is surpassed.

ID	Parameter	CL	Setting range [Default]	Description
			[Class B]	
				Notes For additional information refer to 9.5.4 Alarm Classes
2922	Self acknowledge	2	Yes	The control unit automatically clears the alarm if the fault condition is no longer detected.
			[No]	The control unit does not automatically reset the alarm when the fault condition is no longer detected. The alarm must be acknowledged and reset by manually pressing the appropriate buttons or by activating the LogicsManager output "External acknowledgment" (via a discrete input or via an interface).

4.5.1.5.7 Engine/Generator Unloading Mismatch

General notes

This monitoring function is always enabled and becomes active when a stop command is issued. Following a stop command, the controller tries to reduce the power before opening the GCB. If the power falls below the unload limit (parameter [3125](#)) before the delay (parameter [3123](#)) expires, a "GCB open" command will be issued. If the controller fails to reduce the power to fall below the unload limit (parameter [3125](#)) before the delay (parameter [3123](#)) expires, a "GCB open" command will be issued together with an alarm.



If this protective function is triggered, the display indicates "Gen. unloading fault" and the logical command variable "06.30" will be enabled.

ID	Parameter	CL	Setting range [Default]	Description
3120	Monitoring	2	[On]	Monitoring of engine unloading is carried out according to the following parameters.
			Off	Monitoring is disabled.
3125	Unload limit	2	0.5 to 99.9% [3.0%]	If the monitored generator power falls below this value, a "GCB open" command will be issued.
				Notes This value refers to the generator rated active power (parameter 1752).

ID	Parameter	CL	Setting range [Default]	Description
3123	Delay	2	3 to 999 s [60 s]	If the monitored generator power does not fall below the limit configured in parameter 3125 before the time configured here expires, a "GCB open" command will be issued together with an alarm. The GCB will be opened after this time even if 3120 is configured to OFF.
3121	Alarm class	2	Class A, Class B, Class C, Class D, Class E, Class F , Control [Class B]	Each limit may be assigned an independent alarm class that specifies what action should be taken when the limit is surpassed.
				Notes For additional information refer to "9.5.4 Alarm Classes"
3122	Self acknowledge	2	Yes	The control unit automatically clears the alarm if the fault condition is no longer detected.
			[No]	The control unit does not automatically reset the alarm when the fault condition is no longer detected. The alarm must be acknowledged and reset by manually pressing the appropriate buttons or by activating the LogicsManager output "External acknowledgment" (via a discrete input or via an interface).

4.5.1.6 Other Monitoring

4.5.1.6.1 Power Factor - configure generator power factor monitoring

4.5.1.6.1.1 Generator Lagging Power Factor (Level 1 & 2)

General notes

The power factor is monitored for becoming more lagging (i.e. inductive) than an adjustable limit. This limit may be a lagging or leading power factor limit. There are two lagging power factor alarm levels available in the control. This monitoring function may be used for monitoring an overexcitation with a warning and a shutdown alarm level. Both alarms are definite time alarms.



The power factor monitoring

- is activated,
if the generator current expires 5% rated Generator current and
- is blocked,
if the generator current underrun 3% rated Generator current.

↳ Fig. 216 shows an example of a leading and a lagging power factor limit and the power factor range, for which the lagging power factor monitoring issues an alarm.



If this protective function is triggered, the display indicates "Gen. PF lagging 1" or "Gen. PF lagging 2" and the logical command variable "06.25" or "06.26" will be enabled.

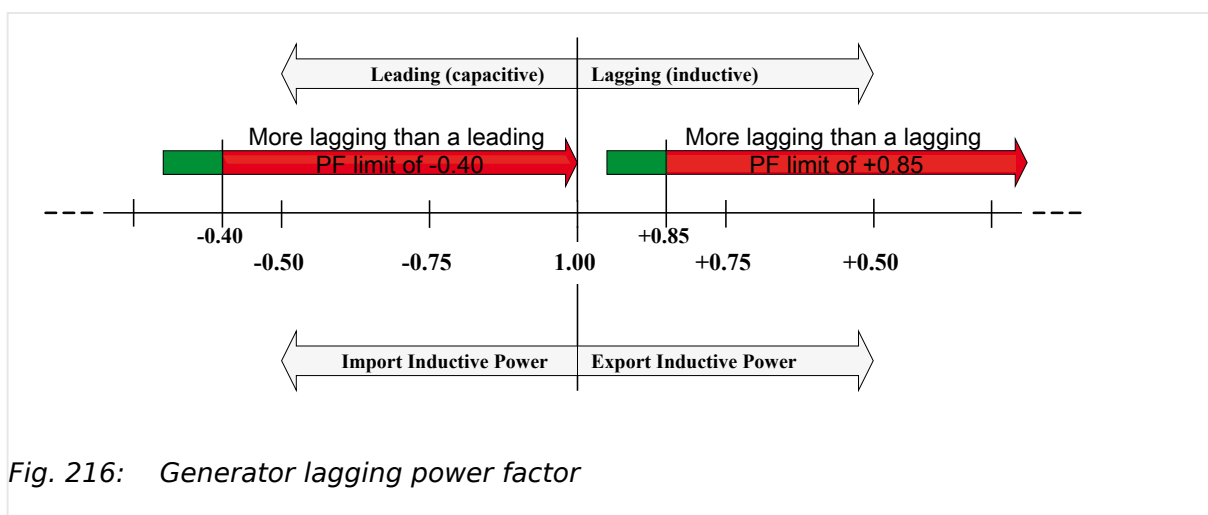

Fig. 216: Generator lagging power factor

ID	Parameter	CL	Setting range [Default]	Description
2325 2331	Monitoring	2	[On]	Generator lagging power factor monitoring is carried out according to the following parameters. Monitoring is performed at two levels. Both values may be configured independent from each other.
			Off	Monitoring is disabled for Level 1 limit and/or Level 2 limit.
2329 2335	Limit	2	-0.999 to 1.000 2329 [+ 0.900] 2335: [+ 0.700] (Hysteresis: 0.02%) (Reset Delay: 80 ms)	The values that are to be monitored for each threshold limit are defined here.
				Notes If the power factor becomes more lagging (i.e. inductive, ↳ Fig. 216) than a lagging PF value (positive) or a leading PF value (negative) for at least the delay time (parameters ↳ 2330 or ↳ 2336) without interruption,

4 Configuration

4.5.1.6.1.1 Generator Lagging Power Factor (Level 1 & 2)

ID	Parameter	CL	Setting range [Default]	Description
				the action specified by the alarm class is initiated.
2330 2336	Delay	2	0.02 to 99.99 s 2330: [30.00 s] 2336: [10.00 s]	<p>If the monitored generator power factor is more lagging than the configured limit for the delay time configured here, an alarm will be issued.</p> <p>Notes</p> <p>If the monitored generator power factor returns within the limit before the delay expires the time will be reset.</p>
2326 2332	Alarm class	2	Class A, Class B, Class C, Class D, Class E, Class F , Control 2326: [Class B] 2332: [Class B]	<p>Each limit may be assigned an independent alarm class that specifies what action should be taken when the limit is surpassed.</p> <p>Notes</p> <p>For additional information refer to ↪ "9.5.4 Alarm Classes"</p>
2327 2333	Self acknowledge	2 4	Yes [No]	<p>The control unit automatically clears the alarm if the fault condition is no longer detected.</p> <p>The control unit does not automatically reset the alarm when the fault condition is no longer detected.</p> <p>The alarm must be acknowledged and reset by manually pressing the appropriate buttons or by activating the LogicsManager output "External acknowledgment" (via a discrete input or via an interface).</p>
2328 2334	Enabled	2	Always [87.70 LM:Eng.mon] <i>For xx = 1 to 32:</i> 96.{xx} LM: Flag{xx}	<p>Monitoring for this fault condition is continuously enabled.</p> <p>Monitoring for fault conditions is not performed until engine monitoring is enabled. This is determined through the LogicsManager equation "Release engine monitoring".</p> <p>The monitoring is executed, if the LogicsManager "Flag {xx}" is TRUE.</p> <p>Example:</p> <p>96.01 LM: Flag 1, 96.02 LM: Flag 2, ..., 96.32 LM: Flag 32</p>

4.5.1.6.1.2 Generator Leading Power Factor (Level 1 & 2)

General notes

The power factor is monitored for becoming more leading (i.e. capacitive) than an adjustable limit. This limit may be a leading or lagging power factor limit. There are two leading power factor alarm levels available in the control. This monitoring function may be used for monitoring an under excitation with a warning and a shutdown alarm level. Both alarms are definite time alarms.

Refer to [6.3.1 Generator Excitation Protection](#) for a detailed description of this monitoring function.



The power factor monitoring

- is activated,
if the generator current expires 5% rated Generator current and
- is blocked,
if the generator current underruns 3% rated Generator current.

[Fig. 217](#) shows an example of a leading and a lagging power factor limit and the power factor range, for which the leading power factor monitoring issues an alarm.



If this protective function is triggered, the display indicates "Gen. PF leading 1" or "Gen. PF leading 2" and the logical command variable "06.27" or "06.28" will be enabled.

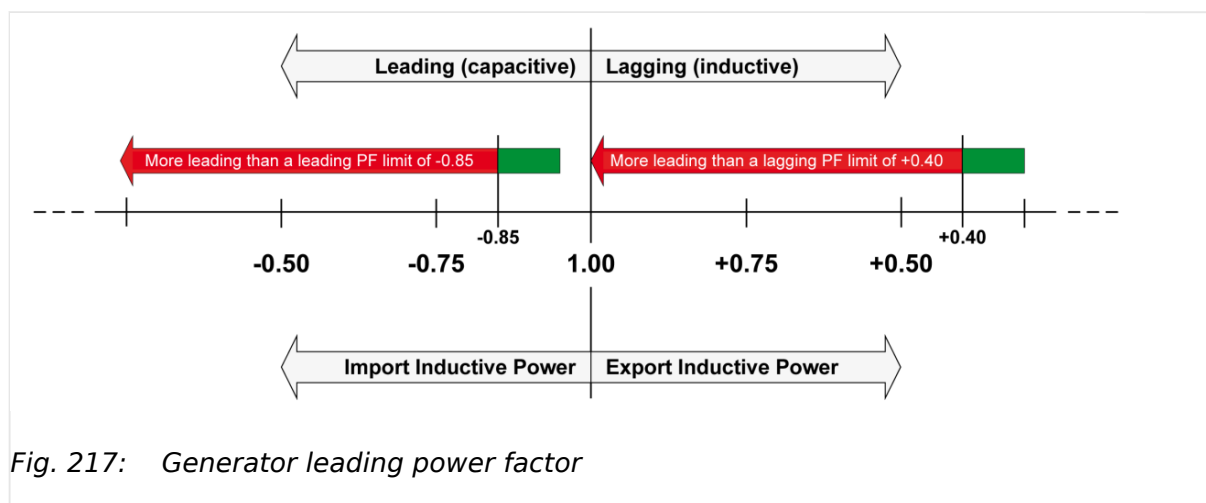

Fig. 217: Generator leading power factor

ID	Parameter	CL	Setting range [Default]	Description
2375 2381	Monitoring	2	[On]	Generator leading power factor monitoring is carried out according to the following parameters. Monitoring is performed at two levels. Both values may be configured independent from each other.

4 Configuration

4.5.1.6.1.2 Generator Leading Power Factor (Level 1 & 2)

ID	Parameter	CL	Setting range [Default]	Description
			Off	Monitoring is disabled for Level 1 limit and/or Level 2 limit.
2379 2385	Limit	2	-0.999 to 1.000 2379: [- 0.900] 2385: [- 0.700] (Hysteresis: 0.02%) (Reset Delay: 80 ms)	The values that are to be monitored for each threshold limit are defined here. Notes If the power factor becomes more leading (i.e. capacitive, ↩ Fig. 217) than a leading PF value (negative) or a lagging PF value (positive) for at least the delay time (parameters ↩ 2380 or ↩ 2386) without interruption, the action specified by the alarm class is initiated.
2380 2386	Delay	2	0.02 to 99.99 s 2380: [30.00 s] 2386: [10.00 s]	If the monitored generator power factor is more leading than the configured limit for the delay time configured here, an alarm will be issued. Notes If the monitored generator power factor returns within the limit before the delay expires the time will be reset.
2376 2382	Alarm class	2	Class A, Class B, Class C, Class D, Class E, Class F , Control 2376: [Class B] 2382: [Class B]	Each limit may be assigned an independent alarm class that specifies what action should be taken when the limit is surpassed. Notes For additional information refer to ↩ "9.5.4 Alarm Classes"
2377 2383	Self acknowledge	2 4	Yes [No]	The control unit automatically clears the alarm if the fault condition is no longer detected. The control unit does not automatically reset the alarm when the fault condition is no longer detected. The alarm must be acknowledged and reset by manually pressing the appropriate buttons or by activating the LogicsManager output "External acknowledgment" (via a discrete input or via an interface).
2378 2384	Enabled	2	Always [87.70 LM:Eng.mon]	Monitoring for this fault condition is continuously enabled. Monitoring for fault conditions is not performed until engine monitoring is enabled. This is determined through the LogicsManager equation "Release engine monitoring".

ID	Parameter	CL	Setting range [Default]	Description
			For $xx = 1$ to 32 : 96.{xx} LM: Flag{xx}	The monitoring is executed, if the LogicsManager "Flag {xx}" is TRUE. Example: 96.01 LM: Flag 1, 96.02 LM: Flag 2, ..., 96.32 LM: Flag 32

4.5.1.6.2 Miscellaneous

4.5.1.6.2.1 Generator Ground Fault (Level 1 & 2)

General notes



The generator ground fault is determined differently depending on the following configuration options:

- Mains current input is configured for mains current
(calculated ground fault)
- Mains current input is configured for ground current
(measured ground fault)

Refer to parameter 1854.

Calculated ground fault

The current produced by the generator is monitored depending on how parameter "Generator current measuring" (parameter 1850) is configured. The measured three conductor currents IGen-L1, IGen-L2 and IGen-L3 are vectorially totaled ($I_S = I_{Gen-L1} + I_{Gen-L2} + I_{Gen-L3}$) and compared with the configured fault limit (the calculated actual value is indicated in the display). If the measured value exceeds the fault threshold limit, a ground fault is present, and an alarm is issued.

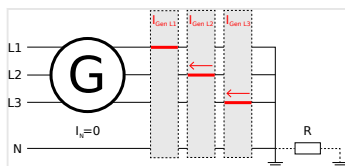



Fig. 218: Generator ground fault - schematic



If this protective function is triggered, the display indicates "Ground fault 1" or "Ground fault 2" and the logical command variable "06.19" or "06.20" will be enabled.

 The ground fault protection zone is determined by the location where the generator current transformer are physically installed.

-  **Test**
1. ▷ Short-circuit one of the three generator current transformers while the generator is at full load.
 - ▶ The measured current should read 100% of rated on the two phases that do not have their current transformers short-circuited.

The ground current calculation does not take current on the neutral conductor into consideration. In order for the controller to be able to perform calculated ground fault current protection accurately, the neutral conductor must not conduct current.

The fault threshold value is configured as a percentage. This percentage threshold refers to the generator rated current (parameter \hookrightarrow 1754). Due to unavoidable load asymmetries, the minimum value for this parameter should be 10% or greater.

Calculation

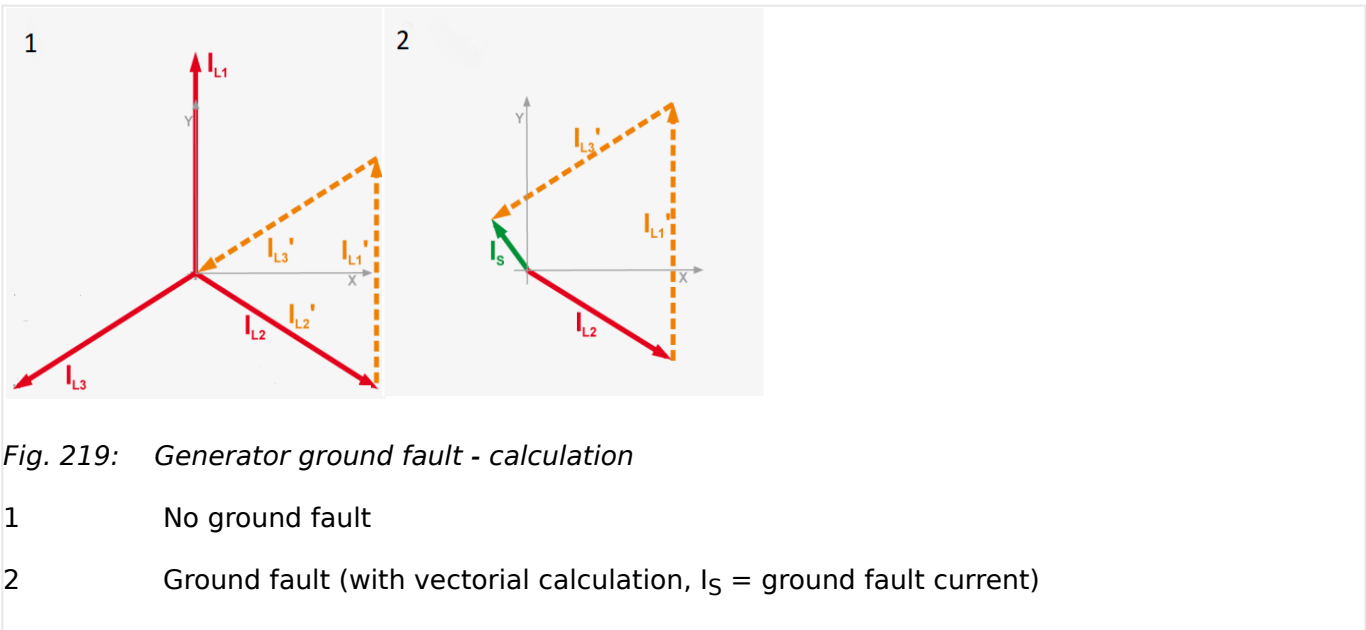

The ground current I_S is calculated geometrically/vectorially. For that the three vectors for the three currents are summed (chained) together as shown in (\hookrightarrow Fig. 219).

The vector between the neutral point and the result of the sum is then the ground current I_S as shown in (\hookrightarrow Fig. 219/2).

If the three currents are in 120° phase relation to each other, the ground fault current can be approximately calculated using the following formula:

- $((I_{L1rated} + I_{L2rated} + I_{L3rated}) - (I_{L1measured} + I_{L2measured} + I_{L3measured})) / 1.732 = I_S$

Calculation example:

- Phase current $I_{L1} = I_{Rated} = 7 \text{ A}$

- Phase current $I_{L2} = 6.5 \text{ A}$
- Phase current $I_{L3} = 6 \text{ A}$
- this results in ground fault current = $(7 \text{ A} + 7 \text{ A} + 7 \text{ A}) - (7 \text{ A} + 6.5 \text{ A} + 6 \text{ A}) / 1.732 = 0.866 \text{ A}$

Measured ground fault

Ground fault current is actively measured when the mains current input is configured to monitor for ground current. The ground fault threshold is configured as a percentage of the value entered for parameter "Generator rated current" (parameter [↩ 1754](#)).



The ground fault protection zone is determined by the physical installation location of the generator current transformer.

ID	Parameter	CL	Setting range [Default]	Description
3250 3256	Monitoring	2	On	Ground current monitoring is carried out according to the following parameters. Monitoring is performed at two levels. Both values may be configured independent from each other (prerequisite: Level 1 < Level 2).
[Off]			Monitoring is disabled for Level 1 limit and/or Level 2 limit.	
3254 3260	Limit	2	0 to 300% 3254: [10%] 3260: [30%] (Hysteresis: 1%) (Reset Delay: 80 ms)	The percentage values that are to be monitored for each threshold limit are defined here. If this value is reached or exceeded for at least the delay time without interruption, the action specified by the alarm class is initiated.
Notes			This value refers to the Generator rated current of the generator (parameter ↩ 1754), if the ground current is calculated from the generator current values. It refers to the parameter "Generator rated current" (parameter ↩ 1754), if the ground current is measured directly. The ground fault threshold must not exceed the mains/ground current measuring range (approx. $1.5 \times I_{rated}$; ↩ "8.1 Technical Data").	
3255 3261	Delay	2	0.02 to 99.99 s 3255: [0.20 s]	If the monitored ground fault exceeds the threshold value for the delay time configured here, an alarm will be issued.

4 Configuration

4.5.1.6.2.1 Generator Ground Fault (Level 1 & 2)

ID	Parameter	CL	Setting range [Default]	Description
			3261: [0.10 s]	<p>Notes</p> <p>If the monitored ground fault falls below the threshold (minus the hysteresis) before the delay expires the time will be reset.</p>
3251 3257	Alarm class	2	Class A, Class B, Class C, Class D, Class E, Class F , Control 3251: [Class B] 3257: [Class F]	<p>Each limit may be assigned an independent alarm class that specifies what action should be taken when the limit is surpassed.</p> <p>Notes</p> <p>For additional information refer to “9.5.4 Alarm Classes”</p>
3252 3258	Self acknowledge	2 4	Yes [No]	<p>The control unit automatically clears the alarm if the fault condition is no longer detected.</p> <p>The control unit does not automatically reset the alarm when the fault condition is no longer detected.</p> <p>The alarm must be acknowledged and reset by manually pressing the appropriate buttons or by activating the LogicsManager output "External acknowledgment" (via a discrete input or via an interface).</p>
3253 3259	Enabled	4	[Always] 87.70 LM:Eng.mon <i>For xx = 1 to 32:</i> 96.{xx} LM: Flag{xx}	<p>Monitoring for this fault condition is continuously enabled.</p> <p>Monitoring for fault conditions is not performed until engine monitoring is enabled. This is determined through the LogicsManager equation "Release engine monitoring".</p> <p>The monitoring is executed, if the LogicsManager "Flag {xx}" is TRUE.</p> <p>Example:</p> <p>96.01 LM: Flag 1, 96.02 LM: Flag 2, ..., 96.32 LM: Flag 32</p>

4.5.1.6.2.2 Generator Phase Rotation

General notes

NOTICE!



Damage to the control unit and/or generation equipment

- Ensure that the control unit is properly connected to phase voltages on both sides of the circuit breaker(s) during installation.

Failure to do so may result in damage to the control unit and/or generation equipment due to the breaker closing asynchronously or with mismatched phase rotations. Also ensure that phase rotation monitoring is enabled at all connected components (engine, generator, breakers, cable, busbars, etc.).

This function will block a connection of systems with mismatched phases only under the following conditions:

- The voltages being measured are wired correctly with respect to the phase rotation at the measuring points (i.e. the potential transformers in on both sides of the circuit breaker)
- The voltages being measured are wired so that angular phase shifts or any interruptions from the measuring point to the control unit do not exist
- The voltages being measured are wired to the correct terminals of the control unit (i.e. L1 phase of the generator is connected with the terminal of the control unit which is intended for the generator L1 phase)
- The configured alarm class is of class C, D, E, or F (shutdown alarm).





Correct phase rotation of the phase voltages ensures that damage will not occur during a breaker closure to either the mains or the generator. The voltage phase rotation alarm checks the phase rotation of the measured voltages and the configured phase rotation to ensure they are identical.

The directions of rotation are differentiated as "clockwise" and "counter clockwise". With a clockwise field the direction of rotation is "L1-L2-L3"; with a counter clockwise field the direction of rotation is "L1-L3-L2". If the control is configured for a clockwise rotation and the measured voltages are monitored as counterclockwise, the alarm will be initiated.



The direction of configured rotation being monitored by the control unit is displayed on the screen.

If this protective function is triggered, the display indicates "Gen.ph.rot. mismatch" and the logical command variable "06.21" will be enabled.

This monitoring function is only enabled if Generator voltage measuring (parameter  1851) is configured to "3Ph 4W", "3Ph 3W", or "3Ph 4W OD" and the measured voltage exceeds 50 % of the rated voltage (parameter  1766) or if Generator voltage measuring (parameter  1851) is configured to "1Ph 2W" (in this case, the phase rotation is not evaluated, but defined by the 1Ph2W phase rotation (parameter  1859)).

4 Configuration

4.5.1.6.2.2 Generator Phase Rotation

ID	Parameter	CL	Setting range [Default]	Description
3950	Monitoring	2	[On]	Phase rotation monitoring is carried out according to the following parameters. Notes The phase rotation monitor is internally configured with a two seconds delay, so that the expected response time is less than three seconds.
			Off	No monitoring is carried out.
3954	Generator phase rotation	2	[CW]	The three-phase measured generator voltage is rotating CW (clock-wise; that means the voltage rotates in L1-L2-L3 direction; standard setting).
			CCW	The three-phase measured generator voltage is rotating CCW (counter clock-wise; that means the voltage rotates in L1-L3-L2 direction).
3951	Alarm class	2	Class A, Class B, Class C, Class D, Class E, Class F , Control [Class F]	Each limit may be assigned an independent alarm class that specifies what action should be taken when the limit is surpassed. Notes For additional information refer to "9.5.4 Alarm Classes"
3952	Self acknowledge	4	Yes	The control unit automatically clears the alarm if the fault condition is no longer detected.
			[No]	The control unit does not automatically reset the alarm when the fault condition is no longer detected. The alarm must be acknowledged and reset by manually pressing the appropriate buttons or by activating the LogicsManager output "External acknowledgment" (via a discrete input or via an interface).
3953	Enabled	2	[Always]	Monitoring for this fault condition is continuously enabled.
			87.70 LM:Eng.mon	Monitoring for fault conditions is not performed until engine monitoring is enabled. This is determined through the LogicsManager equation "Release engine monitoring".
			For xx = 1 to 32: 96.{xx} LM: Flag{xx}	The monitoring is executed, if the LogicsManager "Flag {xx}" is TRUE. Example:

ID	Parameter	CL	Setting range [Default]	Description
				96.01 LM: Flag 1, 96.02 LM: Flag 2, ..., 96.32 LM: Flag 32

4.5.1.6.2.3 Busbar Phase Rotation

General notes**NOTICE!****Damage to the control unit and/or generation equipment**

- Ensure that the control unit is properly connected to phase voltages on both sides of the circuit breaker(s) during installation.

Failure to do so may result in damage to the control unit and/or generation equipment due to the breaker closing asynchronously or with mismatched phase rotations. Also ensure that phase rotation monitoring is enabled at all connected components (engine, generator, breakers, cable, busbars, etc.).

This function will block a connection of systems with mismatched phases only under the following conditions:

- The voltages being measured are wired correctly with respect to the phase rotation at the measuring points (i.e. the potential transformers in on both sides of the circuit breaker)
- The voltages being measured are wired so that angular phase shifts or any interruptions from the measuring point to the control unit do not exist
- The voltages being measured are wired to the correct terminals of the control unit (i.e. L1 phase of the generator is connected with the terminal of the control unit which is intended for the generator L1 phase)
- The configured alarm class is of class C, D, E, or F (shutdown alarm).

Correct phase rotation of the phase voltages ensures that damage will not occur during a breaker closure to either the mains or the generator. The voltage phase rotation alarm checks the phase rotation of the measured voltages and the configured phase rotation to ensure they are identical.

The directions of rotation are differentiated as "clockwise" and "counter clockwise". With a clockwise field the direction of rotation is "L1-L2-L3"; with a counter clockwise field the direction of rotation is "L1-L3-L2". If the control is configured for a clockwise rotation and the measured voltages are monitored as counterclockwise, the alarm will be initiated.



The direction of configured rotation being monitored by the control unit is displayed on the screen.

If this protective function is triggered, the display indicates "Gen.ph.rot. mismatch" and the logical command variable "06.21" will be enabled.

This monitoring function is only enabled if Generator voltage measuring (parameter [1851](#)) is configured to "3Ph 4W", "3Ph 3W", or "3Ph 4W OD" and the measured voltage exceeds 50 % of the rated voltage (parameter [1766](#)) or if Generator voltage measuring (parameter [1851](#)) is configured to "1Ph 2W" (in this case, the phase rotation is not evaluated, but defined by the 1Ph2W phase rotation (parameter [1859](#))).

ID	Parameter	CL	Setting range [Default]	Description
1924	Monitoring	2	[On]	Phase rotation monitoring is carried out according to the following parameters. Notes The phase rotation monitor is internally configured with a two seconds delay, so that the expected response time is less than three seconds.
			Off	No monitoring is carried out.
1925	Busbar phase rotation	2	[CW]	The three-phase measured generator voltage is rotating CW (clock-wise; that means the voltage rotates in L1-L2-L3 direction; standard setting).
			CCW	The three-phase measured generator voltage is rotating CCW (counter clock-wise; that means the voltage rotates in L1-L3-L2 direction).
1926	Alarm class	2	Class A, Class B, Class C, Class D, Class E, Class F , Control [Class F]	Each limit may be assigned an independent alarm class that specifies what action should be taken when the limit is surpassed. Notes For additional information refer to "9.5.4 Alarm Classes"
1927	Self acknowledge	4	Yes	The control unit automatically clears the alarm if the fault condition is no longer detected.
			[No]	The control unit does not automatically reset the alarm when the fault condition is no longer detected. The alarm must be acknowledged and reset by manually pressing the appropriate buttons or by activating the LogicsManager output "External"

ID	Parameter	CL	Setting range [Default]	Description
				acknowledgment" (via a discrete input or via an interface).
1928	Enabled	2	[Always]	Monitoring for this fault condition is continuously enabled.
			87.70 LM:Eng.mon	Monitoring for fault conditions is not performed until engine monitoring is enabled. This is determined through the LogicsManager equation "Release engine monitoring".
			For xx = 1 to 32: 96.{xx} LM: Flag{xx}	The monitoring is executed, if the LogicsManager "Flag {xx}" is TRUE. Example: 96.01 LM: Flag 1, 96.02 LM: Flag 2, ..., 96.32 LM: Flag 32

4.5.1.6.3 Pole Slip Monitoring

General notes

There are different circumstances possible to bring a synchronous generator into a pole slip situation. This monitor here is established for pole slip cases, when the genset is running parallel to grid. Because in mains instability situations in conjunction with being longer parallel to grid (VDE-AR-N 4105/4110) it can lead to situations that the synchronous generator goes through pole-slips. These pole slips stress the genset mechanically very hard and must be monitored. Finally the generator is to decouple from mains, if the pole-slip rate reaches a scale which damages the genset.

Because the easYgenXT is connected on measurement CTs the device follows a monitoring method based on power measurement in conjunction with other circumstances.

Function

A pole slip situation is detected through observing the power output of the generator in a special moment (refer to release pole slip). In this moment when the power changes from positive to negative and back to positive one pole slip event is detected.

Release pole slip

(Prerequisites to observe a pole slip situation)

- The monitoring is enabled (ON)
- The mains parallel operation is detected (GCB closed, MCB closed and GGB closed)
- The Generator active power is higher than a configurable "Min. active power threshold"
- The difference between active power and active power set point is higher than the threshold. If the active power controller is not active (external active power control), the threshold must be set to 0%.

Trigger condition for a pole slip event

(Trigger the pole slip event counter +1)

- The active power has changed from positive to negative and back to positive.

AND (If Pole slip with current limit is enabled)

- The generator current has surpassed a configurable limit

AND (If Pole slip with pickup is enabled)

- A configurable difference is detected between pickup speed and the measured generator frequency.

Trigger pole slip alarm

If the number of pole slip events are equal or higher than the configurable limit.

Reset pole slip event counter

If, during released pole slip monitoring, no pole slip event is encountered anymore for a configurable time, the event counter is reset.

ID	Parameter	CL	Setting range [Default]	Description
2416	Monitoring	2	On	Enabling the pole slip monitoring. On: Monitoring is enabled
			[Off]	Off: Monitoring is disabled
2417	Minimum active power	2	0 to 150%	With reaching once this minimum active power in parallel operation the pole slip monitoring is released. The entry is related to generator rated power.
			[10%]	
2418	Limit active power difference	2	0 to 150%	This difference between real power and set point triggers the monitoring. If the difference is higher than the configured threshold the pole slip events are taken into account.
			[10%]	
2426	Pole slip with current limit	2	On	Use additional the generator current limit for detecting pole slip events. On: Current limit is additional used for pole slip detection
			[Off]	Off: Current limit is not used
2427	Generator current limit	2	50 to 200%	If the generator current is higher than the threshold during active power decreasing the current condition for pole slip events is matched.
			[110%]	
2428	Pole slip with pickup	2	On	Use additional the difference between pickup and generator frequency for detecting pole slip events

ID	Parameter	CL	Setting range [Default]	Description
				On: Use the difference between pickup and frequency
			[Off]	Off: Difference between pickup and frequency is not used
2429	Speed/frequency difference	2	0.5 to 9.9 Hz [2.0 Hz]	If the difference between speed and frequency is higher than the threshold the pickup condition for pole slip events is matched. The pickup speed is calculated to frequency for the compare with the generator frequency from the AC measurement.
2419	Number of pole slip events	2	1 to 10 [2]	This is the maximum allowed number of pole slips to trigger the alarm.
2420	Reset time pole slip events	2	10 to 999 s [60 s]	During released pole slip monitoring and with a pole slip counter which is not increased anymore for this time, the pole slip counter will be reset.
2421	Alarm class	2	Class A, Class B, Class C, Class D, Class E, Class F , Control [Class D]	Pole slip alarm class. Default alarm class D opens the GCB and stops the engine after cooldown timer.
2422	Self acknowledge	2	Yes [No]	Self-acknowledge pole slip alarm
2423	Mains decoupling by pole slip	2	On [Off]	Use pole slip monitoring for mains decoupling

Alarm

The device indicates and stores the text "Pole slip" (ID2424).

Visualization

The device indicates "Pole slip events" in ToolKit (ID2425).

LogicsManager

The device provides the LM command variable "06.36 Pole slip" (10674).

AnalogManager

The device provides the AM variable "01.86 Number of pole slips" (9765).

4.5.2 Configure Engine Monitor

4.5.2.1 Engine Overspeed (Level 1 & 2) ANSI# 12

General notes

The speed measured by the magnetic pickup unit (MPU) is monitored for overspeed. If the MPU is disabled, the speed may only be monitored using the generator overfrequency monitoring. If the MPU speed exceeds the overspeed limits the configured alarms will be initiated.



If this protective function is triggered, the display indicates "Overspeed 1" or "Overspeed 2" and the logical command variable "05.01" or "05.02" will be enabled.

Refer to [↪ "9.1.1 Triggering Characteristics"](#) for the triggering characteristic of this monitoring function.

ID	Parameter	CL	Setting range [Default]	Description
2100 2106	Monitoring	2	[On] Off	Overspeed monitoring is carried out according to the following parameters. Monitoring is performed at two levels. Both values may be configured independent from each other (prerequisite: Level 1 > Level 2). Monitoring is disabled for Level 1 limit and/or Level 2 limit.
2104 2110	Limit	2	0 to 9,999 rpm 2104: [1,850 rpm] 2110: [1,900 rpm] (Hysteresis: 50 rpm) (Reset Delay: 1 s)	The revolutions per minute (rpm) values that are to be monitored for each threshold limit are defined here. If this value is reached or exceeded for at least the delay time without interruption, the action specified by the alarm class is initiated.
2105 2111	Delay	2	0.02 to 99.99 s 2105: [1.00 s] 2111: [0.10 s]	If the monitored engine speed exceeds the threshold value for the delay time configured here, an alarm will be issued. Notes If the monitored engine speed falls below the threshold (minus the hysteresis) before the delay expires the time will be reset.
2101 2107	Alarm class	2	Class A, Class B, Class C, Class D, Class E, Class F , Control 2101: [Class B] 2107: [Class F]	Each limit may be assigned an independent alarm class that specifies what action should be taken when the limit is surpassed. Notes For additional information refer to ↪ "9.5.4 Alarm Classes"

ID	Parameter	CL	Setting range [Default]	Description
2102 2108	Self acknowledge	2	Yes	The control unit automatically clears the alarm if the fault condition is no longer detected.
		4	[No]	The control unit does not automatically reset the alarm when the fault condition is no longer detected. The alarm must be acknowledged and reset by manually pressing the appropriate buttons or by activating the LogicsManager output "External acknowledgment" (via a discrete input or via an interface).
2103 2109	Enabled	2	[Always]	Monitoring for this fault condition is continuously enabled.
		4	87.70 LM:Eng.mon	Monitoring for fault conditions is not performed until engine monitoring is enabled. This is determined through the LogicsManager equation "Release engine monitoring".
			For xx = 1 to 32: 96.{xx} LM: Flag{xx}	The monitoring is executed, if the LogicsManager "Flag {xx}" is TRUE. Example: 96.01 LM: Flag 1, 96.02 LM: Flag 2, ..., 96.32 LM: Flag 32

4.5.2.2 Engine Underspeed (Level 1 & 2)

General notes

The speed measured by the magnetic pickup unit (MPU) is monitored for underspeed. If the MPU is disabled or not available, the speed may only be monitored using the generator underfrequency monitoring. If the MPU speed falls below the underspeed limits the configured alarms will be initiated.



If this protective function is triggered, the display indicates "Underspeed 1" or "Underspeed 2" and the logical command variable "05.03" or "05.04" will be enabled.

Refer to [9.1.1 Triggering Characteristics](#) for the triggering characteristic of this monitoring function.

ID	Parameter	CL	Setting range [Default]	Description
2150 2156	Monitoring	2	[On]	Underspeed monitoring is carried out according to the following parameters. Monitoring is performed at two levels. Both values may be configured

4 Configuration

4.5.2.2 Engine Underspeed (Level 1 & 2)

ID	Parameter	CL	Setting range [Default]	Description
				independent from each other (prerequisite: Level 1 > Level 2).
			Off	Monitoring is disabled for Level 1 limit and/or Level 2 limit.
2154 2160	Limit	2	0 to 9999 rpm 2154: [1,300 rpm] 2160: [1,250 rpm] (Hysteresis: 50 rpm) (Reset Delay: 1 s)	The percentage values that are to be monitored for each threshold limit are defined here. If this value is reached or exceeded for at least the delay time without interruption, the action specified by the alarm class is initiated.
2155 2161	Delay	2	0.02 to 99.99 s 2155: [1.00 s] 2161: [0.10 s]	If the monitored engine speed falls below the threshold value for the delay time configured here, an alarm will be issued. Notes If the monitored engine speed exceeds the threshold (plus the hysteresis) again before the delay expires the time will be reset.
2151 2157	Alarm class	2	Class A, Class B, Class C, Class D, Class E, Class F , Control 2151: [Class B] 2157: [Class F]	Each limit may be assigned an independent alarm class that specifies what action should be taken when the limit is surpassed. Notes For additional information refer to 9.5.4 Alarm Classes
2152 2158	Self acknowledge	2 4	Yes [No]	The control unit automatically clears the alarm if the fault condition is no longer detected. The control unit does not automatically reset the alarm when the fault condition is no longer detected. The alarm must be acknowledged and reset by manually pressing the appropriate buttons or by activating the LogicsManager output "External acknowledgment" (via a discrete input or via an interface).
2153 2159	Enabled	2 4	Always [87.70 LM:Eng.mon] <i>For xx = 1 to 32:</i> 96.{xx}	Monitoring for this fault condition is continuously enabled. Monitoring for fault conditions is not performed until engine monitoring is enabled. This is determined through the LogicsManager equation "Release engine monitoring". The monitoring is executed, if the LogicsManager "Flag {xx}" is TRUE.

ID	Parameter	CL	Setting range [Default]	Description
			LM: Flag{xx}	Example: 96.01 LM: Flag 1, 96.02 LM: Flag 2, ..., 96.32 LM: Flag 32

4.5.2.3 Engine/Generator Speed Detection

General notes

Speed detection checks if the generator voltage frequency f (determined from the measured generator voltage) differs from the measured engine speed n (determined from the Pickup signal or the speed measured via ECU/J1939) and determines a difference ($\Delta f - n$).

If the two frequencies are not identical ($\Delta f - n \neq 0$) and the monitored frequency mismatch reaches or exceeds the threshold, an alarm is output. Additionally the LogicsManager output "Firing speed" is checked upon its logical status with respect to the measuring values "generator frequency" and "Pickup speed".



If this protective function is triggered, the display indicates "Speed/freq. mismatch" and the logical command variable "05.07" will be enabled.



Speed/frequency mismatch (n/f mismatch) is carried out if:

1. A MPU is connected to the control and parameter "Speed pickup" (parameter ) 1600), is configured On.
2. The speed is measured via ECU/J1939.

The following is valid:

The measurement via Pickup is enabled (On):

Mismatch monitoring is carried out using the engine speed from the Pickup and the generator frequency. If the speed/frequency mismatch or the LogicsManager is enabled and the frequency is outside of the configured limit, an alarm will be issued.

The measurement via Pickup is disabled (Off):

Mismatch monitoring is carried out using the generator frequency and the LogicsManager. If the LogicsManager output is enabled and the frequency is outside of the configured limit, an alarm will be issued.

ID	Parameter	CL	Setting range [Default]	Description
2450	Monitoring	2	[On]	Monitoring of the speed/frequency/LogicsManager mismatch ($n/f/LM$ mismatch) is carried out according to the following parameters.

ID	Parameter	CL	Setting range [Default]	Description
			Off	Monitoring is disabled.
2454	Speed/frequency mismatch limit	2	1.5 to 8.5 Hz [5.0 Hz]	The frequency mismatch that is to be monitored is defined here. If the monitored frequency mismatch reaches or exceeds this value for at least the delay time without interruption, the action specified by the alarm class is initiated.
				Notes The LogicsManager is monitored with respect to his status.
2455	Delay	2	1 to 99 s [1 s]	If the monitored frequency mismatch exceeds the threshold value for the delay time configured here, an alarm will be issued.
				Notes If the monitored frequency mismatch falls below the threshold (minus the hysteresis) before the delay expires the time will be reset.
2453	Activation frequency	2	15 to 85 Hz [20 Hz]	The speed/frequency mismatch monitoring is enabled at this generator frequency.
2451	Alarm class	2	Class A, Class B, Class C, Class D, Class E, Class F , Control [Class E]	Each limit may be assigned an independent alarm class that specifies what action should be taken when the limit is surpassed.
				Notes For additional information refer to "9.5.4 Alarm Classes"
2452	Self acknowledge	4	Yes	The control unit automatically clears the alarm if the fault condition is no longer detected.
			[No]	The control unit does not automatically reset the alarm when the fault condition is no longer detected. The alarm must be acknowledged and reset by manually pressing the appropriate buttons or by activating the LogicsManager output "External acknowledgment" (via a discrete input or via an interface).
2458	Enabled	4	Always	Monitoring for this fault condition is continuously enabled.
			[87.70 LM:Eng.mon]	Monitoring for fault conditions is not performed until engine monitoring is enabled. This is

ID	Parameter	CL	Setting range [Default]	Description
				determined through the LogicsManager equation "Release engine monitoring".
			For xx = 1 to 32: 96.{xx} LM: Flag{xx}	The monitoring is executed, if the LogicsManager "Flag {xx}" is TRUE. Example: 96.01 LM: Flag 1, 96.02 LM: Flag 2, ..., 96.32 LM: Flag 32

4.5.2.4 Engine Start Failure

General notes

If it is not possible to start the engine within a configured number of start attempts (refer to [4.4.1.2 Engine Start/Stop](#)), an alarm will be initiated.



If this protective function is triggered, the display indicates "Start fail" and the logical command variable "05.08" will be enabled.

ID	Parameter	CL	Setting range [Default]	Description
3303	Monitoring	4	[On]	Monitoring of the start sequence is carried out according to the following parameters.
			Off	Monitoring is disabled.
3304	Alarm class	2	Class A, Class B, Class C, Class D, Class E, Class F , Control [Class F]	Each limit may be assigned an independent alarm class that specifies what action should be taken when the limit is surpassed.
				Notes For additional information refer to 9.5.4 Alarm Classes
3305	Self acknowledge	4	Yes	The control unit automatically clears the alarm if the fault condition is no longer detected.
			[No]	The control unit does not automatically reset the alarm when the fault condition is no longer detected. The alarm must be acknowledged and reset by manually pressing the appropriate buttons or by activating the LogicsManager output "External"

ID	Parameter	CL	Setting range [Default]	Description
				acknowledgment" (via a discrete input or via an interface).

4.5.2.5 Engine Shutdown Malfunction

General notes

If it is not possible to stop the engine within a configured time, an alarm will be initiated.



If this protective function is triggered, the display indicates "Eng. stop malfuncn." and the logical command variable "05.06" will be enabled.



We recommend to assign this monitoring function to a discrete output to be able to shutdown the engine with an external device to provide a shutdown redundancy.

ID	Parameter	CL	Setting range [Default]	Description
2500	Monitoring	2	[On]	Monitoring of the stop sequence is carried out according to the following parameters.
			Off	Monitoring is disabled.
2503	Maximum stop delay	2	3 to 999 s [30 s]	The maximum permissible time between the output of a stop command and the reply that the engine is stopped successfully is defined here.
				Notes If the engine cannot be stopped within this time (this means speed via the Pickup, frequency via the generator voltage, or the LogicsManager is detected) the action specified by the alarm class is initiated.
2501	Alarm class	2	Class A, Class B, Class C, Class D, Class E, Class F , Control [Class F]	Each limit may be assigned an independent alarm class that specifies what action should be taken when the limit is surpassed.
				Notes For additional information refer to 9.5.4 Alarm Classes
2502	Self acknowledge	4	Yes	The control unit automatically clears the alarm if the fault condition is no longer detected.
			[No]	The control unit does not automatically reset the alarm

ID	Parameter	CL	Setting range [Default]	Description
				when the fault condition is no longer detected. The alarm must be acknowledged and reset by manually pressing the appropriate buttons or by activating the LogicsManager output "External acknowledgment" (via a discrete input or via an interface).

4.5.2.6 Engine Unintended Stop

General notes

If an engine stop has been detected without a stop command being issued, an alarm will be initiated.



If this protective function is triggered, the display indicates "Unintended stop" and the logical command variable "05.05" will be enabled.

ID	Parameter	CL	Setting range [Default]	Description
2650	Monitoring	2	[On]	Monitoring of an unintended stop is carried out according to the following parameters.
			Off	Monitoring is disabled.
2651	Alarm class	2	Class A, Class B, Class C, Class D, Class E, Class F , Control [Class F]	Each limit may be assigned an independent alarm class that specifies what action should be taken when the limit is surpassed.
				Notes For additional information refer to 9.5.4 Alarm Classes
2657	Self acknowledge	2	Yes	The control unit automatically clears the alarm if the fault condition is no longer detected.
			[No]	The control unit does not automatically reset the alarm when the fault condition is no longer detected. The alarm must be acknowledged and reset by manually pressing the appropriate buttons or by activating the LogicsManager output "External acknowledgment" (via a discrete input or via an interface).

4.5.2.7 Engine Charge Alternator (D+)

General notes

The charge alternator monitoring issues an alarm if the voltage measured at the auxiliary excitation input D+ (terminal 65) falls below a fix limit.

The fix limit depends on the power supply voltage. If a power supply voltage exceeding 15 V is detected, the unit assumes a 24 V system and uses a limit of 20 V. If a power supply voltage below 15 V is detected, the unit assumes a 12 V system and uses a limit of 9 V.



If this protective function is triggered, the display indicates "Charge alt. low volt" and the logical command variable "05.11" will be enabled.

ID	Parameter	CL	Setting range [Default]	Description
4050	Monitoring	2	On	Monitoring of the charge alternator is carried out according to the following parameters.
			[Off]	Monitoring is disabled.
4055	Delay	2	2 to 9999 s [10 s]	If the voltage measured at the auxiliary excitation input D+ falls below a fixed limit for the time defined here, an alarm will be issued. If the voltage returns within the limit before the delay time expires, the delay time will be reset.
4051	Alarm class	2	Class A, Class B, Class C, Class D, Class E, Class F , Control [Class B]	Each limit may be assigned an independent alarm class that specifies what action should be taken when the limit is surpassed.
				Notes For additional information refer to 9.5.4 Alarm Classes
4052	Self acknowledge	2	Yes	The control unit automatically clears the alarm if the fault condition is no longer detected.
			[No]	The control unit does not automatically reset the alarm when the fault condition is no longer detected. The alarm must be acknowledged and reset by manually pressing the appropriate buttons or by activating the LogicsManager output "External acknowledgment" (via a discrete input or via an interface).
4053	Enabled	2	Always	Monitoring for this fault condition is continuously enabled.

ID	Parameter	CL	Setting range [Default]	Description
			[87.70 LM:Eng.mon]	Monitoring for fault conditions is not performed until engine monitoring is enabled. This is determined through the LogicsManager equation "Release engine monitoring".
			For xx = 1 to 32: 96.{xx} LM: Flag{xx}	The monitoring is executed, if the LogicsManager "Flag {xx}" is TRUE. Example: 96.01 LM: Flag 1, 96.02 LM: Flag 2, ..., 96.32 LM: Flag 32

4.5.2.8 Cylinder Temperature

General Notes



Up to 20 temperatures monitored!

Gas engines needs to be monitored for equal exhaust or cylinder head temperatures. If one cylinder temperature deviates too much from the others, something must be wrong. This could be for example a failed spark plug or a too hot combustion.

The easYgen-3000XT series provides a monitor which supervises the deviation of a single temperature to the average temperature of a group. Whereby either one average temperature exists (inline engine) or two average temperatures are available (V-engine with two banks).

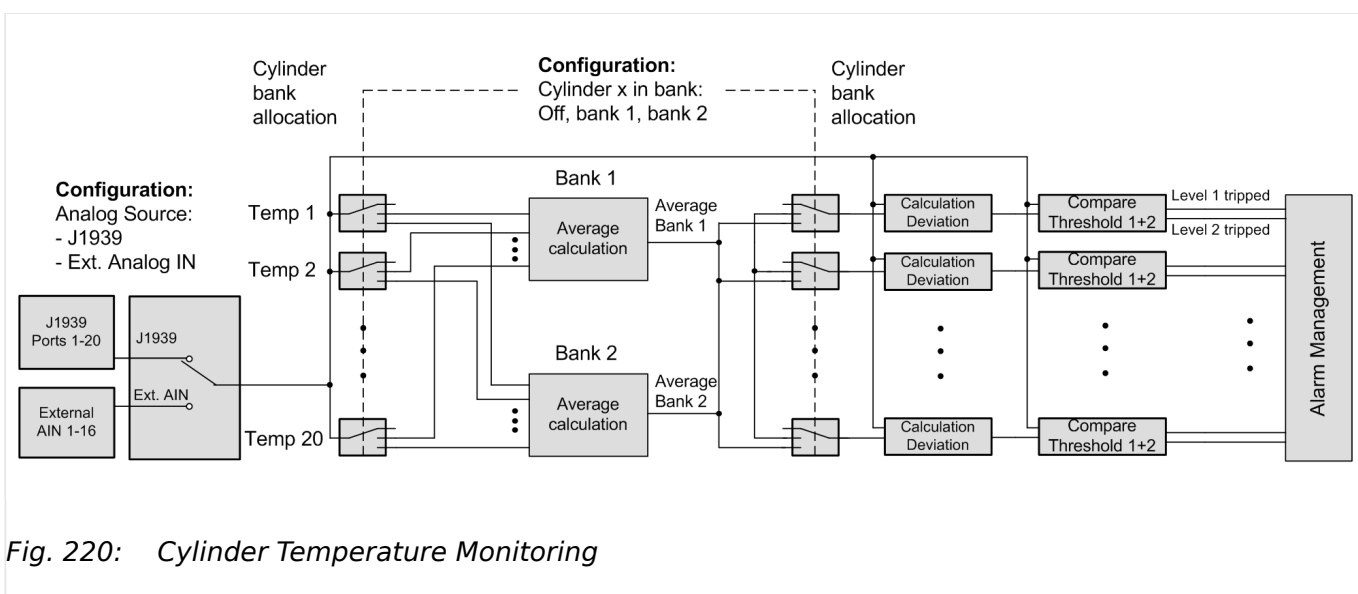

Fig. 220: Cylinder Temperature Monitoring

The monitor is configurable for:

- Overrun,

- Underrun
- or Both.
- Two monitoring levels per temperature measurement.
 - The both levels can be individually activated by different power limits.

The temperatures could be provided by CAN J1939 (SPN 1137 - 1156, 20 ports) for example with Woodward module *LECM Aux 24 Thermocouple* or *Axiomatic Thermocouple Scanner*

Another possibility is to use External Analog Inputs (AI1 - AI16, 16 ports) for example *Phoenix Temperature Modules* or *Wago Temperature Modules*.

Monitoring Function

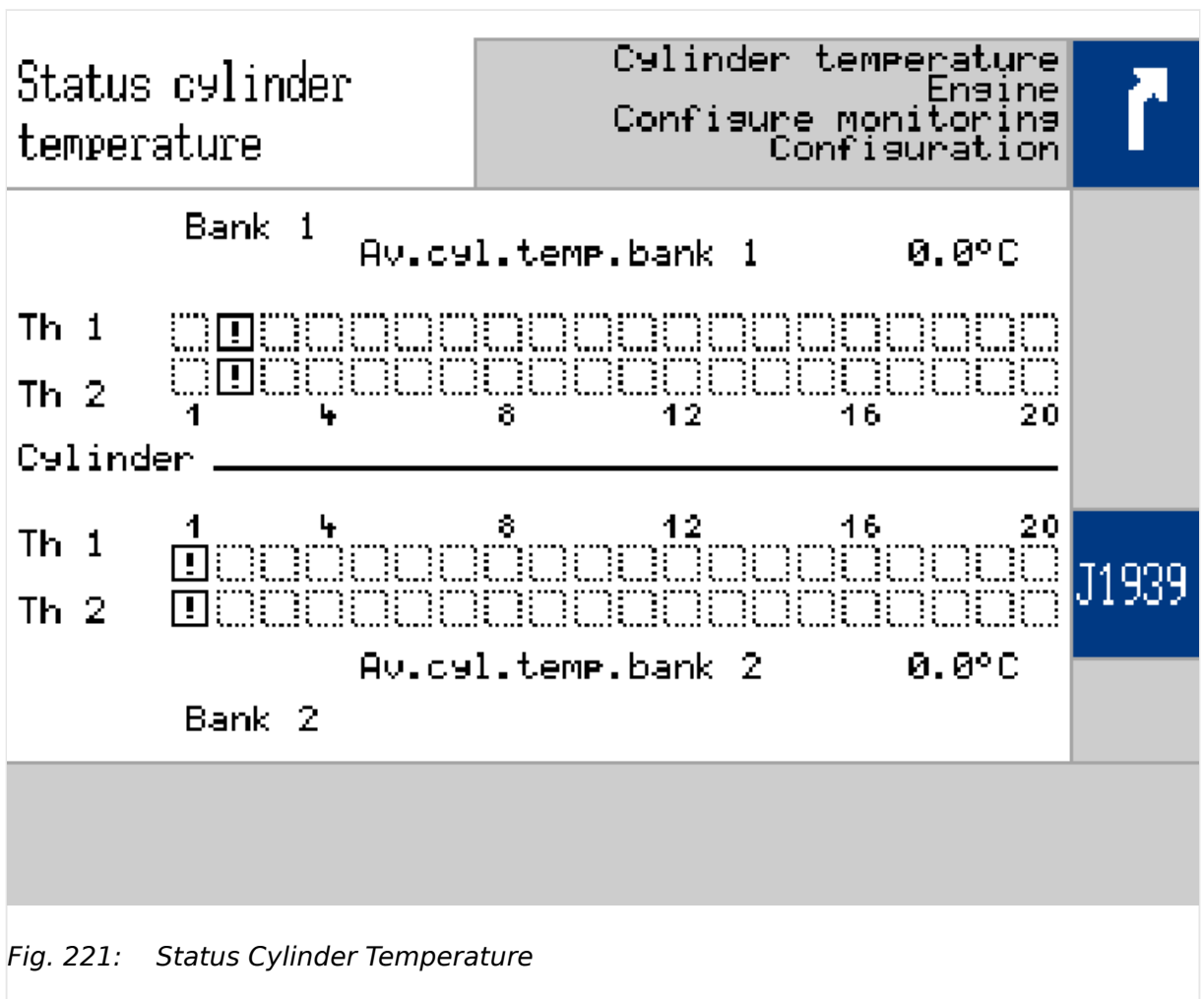

Fig. 221: Status Cylinder Temperature

The monitor compares the single temperature deviations from the average temperature of the according bank. An inline engine has only one group (one bank), so all temperatures are usually allocated to bank 1. A V-engine has two groups (two banks), so the single temperatures are distributed to bank 1 and bank 2. The monitoring mode is valid for all temperatures. The monitoring mode can be 'Off', 'Overrun', 'Underrun' or 'Overrun and Underrun'. The mode is valid for all banks.

The monitoring generally is released by a LogicsManager equation. Each monitoring level (level 1 or 2) can be separately released by a configurable generator power.



A cylinder with sensor defect is removed from the average temperature calculation and trips an independent alarm!

Alarm System / Eventlogger

The alarm system provides three alarm messages:

- Cylinder temperature level 1
- Cylinder temperature level 2
- Wire break

Command Variables

The easYgen provides LogicsManager command variables:

- 87.71 LM: Release cyl.temp.
- 05.18 Cyl.tmp.lev.1
- 05.19 Cyl.tmp.lev.2
- 05.20 Cyl.tmp.wire brk.

Analog Variables

The easYgen provides AnalogManager variables::

- 11.56 Cyl.temp.bank 1 [°C]
- 11.57 Cyl.temp.bank 2 [°C]



- The hysteresis for the temperature limit is 2°C.
- The hysteresis for the power limit is 1% rated generator power.

Alarm Screen

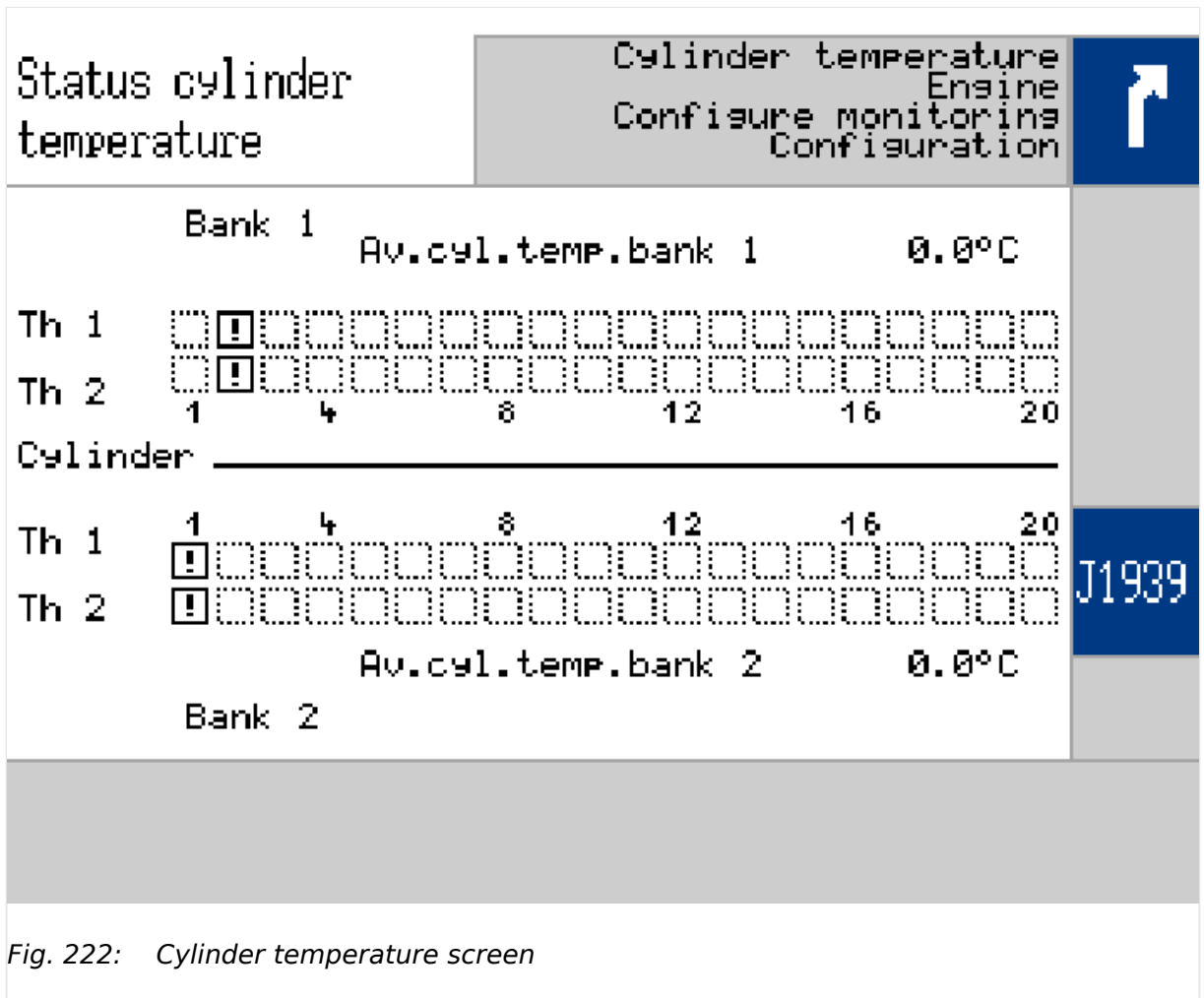

Fig. 222: Cylinder temperature screen

- The square is dotted, if the according cylinder is not configured
- The square contains an arrow-up, if the limit is exceeded
- The square contains an arrow-down, if limit is below target
- The square contains a '!' exclamation point sign, if the sensor is missing (wire break) or error was detected
- If an alarm occurs and the monitor is still active, the new alarm is linked by logic 'OR' to the others
- The monitor ignores values of cylinders with wire break or sensor defect
- The alarm trip displaying is removed, if the alarm of the according level was successful acknowledged
- The wire break trip has a higher priority as the limit monitoring. That means: with up-coming wire break only the according trip bits are RESET. Other cylinders not touched.

General monitoring

ID	Parameter	CL	Setting range [Default]	Description
15158	Release cyl.temp.	2	Determined by LogicsManager 87.71	True: The temperature deviation monitoring is released.
			[(0 & 1) & 1; t_{ON} = 0.00; t_{OFF} = 0.00] = 11460	False: The temperature deviation monitoring is blocked.
8876	Monitoring at	2	[Off]	The monitoring is deactivated. The alarm screen is not displayed.
			Overrun	The single temperatures are monitored on maximum deviation in direction of higher temperatures.
			Underrun	The single temperatures are monitored on maximum deviation in direction of lower temperatures.
			Both	The single temperatures are monitored on maximum deviation in direction of lower and higher temperatures.
8877	Source cylinder temperature	2	Ext. AI	The temperatures are taken from external temperature module (Phoenix, AI1 - AI16, 16 ports).
			[J1939]	The temperatures are taken from the J1939 protocol. (SPN 1137 - 1156, 20 ports).
			Notes Parameter available only if external sources for cylinder temperature are connected.	

Level 1

ID	Parameter	CL	Setting range [Default]	Description
8878	Minimum generator power	2	000.0 ... 150.0%	When the generator power exceeds this value the level 1 monitoring is activated.
			[30.0%]	Respectively the level 1 is deactivated, if the power level is undershoot.
8879	Limit	2	0000 ... 9999° C	Threshold level 1
			[100° C]	
8880	Delay	2	0000 ... 9999 s	Time between exceeding the limit and alarm triggering.
			[60 s]	
8881	Alarm class	2	Class A, Class B, Class C, Class D, Class E, Class F , Control	Each limit may be assigned to an independent alarm class that

ID	Parameter	CL	Setting range [Default]	Description
				specifies what action should be taken when the limit is surpassed.
			[Class B]	For additional information refer to. ↪ "9.5.4 Alarm Classes" .
8882	Self acknowledge	2	Yes	The control unit automatically clears the alarm if the fault condition is no longer detected.
			[No]	The control unit does not automatically reset the alarm when the fault condition is no longer detected. The alarm must be acknowledged and reset by manually pressing the appropriate buttons or by activating the LogicsManager output "External acknowledgment" (via a discrete input or via an interface).

Level 2

ID	Parameter	CL	Setting range [Default]	Description
8883	Minimum generator power	2	000.0 ... 150.0%	When the generator power exceeds this value the level 2 monitoring is activated.
			[30.0%]	Respectively the level 2 is deactivated, if the power level is undershoot.
8884	Limit	2	0000 ... 9999° C	Threshold level 2
			[150° C]	
8886	Alarm class	2	Class A, Class B, Class C, Class D, Class E, Class F , Control	Each limit may be assigned to an independent alarm class that specifies what action should be taken when the limit is surpassed.
			[Class B]	For additional information refer to. ↪ "9.5.4 Alarm Classes" .
8885	Delay	2	0000 ... 9999 s	Time between exceeding the limit and alarm triggering.
			[60 s]	
8887	Self acknowledge	2	Yes	The control unit automatically clears the alarm if the fault condition is no longer detected.
			[No]	The control unit does not automatically reset the alarm when the fault condition is no longer detected. The alarm must be acknowledged and reset by manually pressing the appropriate buttons or by activating the LogicsManager output "External

ID	Parameter	CL	Setting range [Default]	Description
				acknowledgment" (via a discrete input or via an interface).

Wirebreak Cylinder Temperature

ID	Parameter	CL	Setting range [Default]	Description
8890	Delay	2	0000 ... 9999 s [2 s]	Time between *** exceeds limits and *** is activated.
8888	Alarm class	2	Class A, Class B, Class C, Class D, Class E, Class F , Control [Class B]	Each limit may be assigned to an independent alarm class that specifies what action should be taken when the limit is surpassed. For additional information refer to. ↪ "9.5.4 Alarm Classes" .
8889	Self acknowledge	2	Yes [No]	The control unit automatically clears the alarm if the fault condition is no longer detected. The control unit does not automatically reset the alarm when the fault condition is no longer detected. The alarm must be acknowledged and reset by manually pressing the appropriate buttons or by activating the LogicsManager output "External acknowledgment" (via a discrete input or via an interface).

Temperature X Bank

ID	Parameter	CL	Setting range [Default]	Description
8856 to 8875	Bank selection cylinder 1	2	[Off] Bank 1 Bank 2	The temperature does not exist. The temperature exists and is located in cylinder bank 1. The temperature exists and is located in cylinder bank 2.

Cylinder status

Each cylinder is represented by a 2-bit combination that has the following meanings:

- 00 - OK
- 01 - Overrun
- 10 - Underrun

- 11 - Error/missing

These two bits are carried by parameters ID 3352 ..3354 for the cylinders of bank 1 and ID 3355..3357 for the cylinders of bank 2:

Bank	Cylinder	ID	Bits	Bank	Cylinder	ID	Bits
1	1	3352	0..1	2	1	3355	0..1
	2		2..3		2		2..3

	8		14..15		8		14..15
	9	3353	0..1		9	3356	0..1
	10		2..3		10		2..3

	16		14..15		16		14..15
	17	3354	0..1		17	3357	0..1
	18		2..3		18		2..3
	19		4..5		19		4..5
	20		6..7		20		6..7
	(not in use)		8..15		(not in use)		8..15

4.5.3 Mains

4.5.3.1 General Mains Monitoring

ID	Parameter	CL	Setting range [Default]	Description
1771	Mains voltage monitoring	2		The unit can either monitor the wye voltages (phase-neutral) or the delta voltages (phase-phase). The monitoring of the wye voltage is above all necessary to avoid earth-faults in a compensated or isolated network resulting in the tripping of the voltage protection.
			[Phase - phase]	The phase-phase voltage will be monitored and all subsequent parameters concerning voltage monitoring "mains" are referred to this value (VL-L).
			Phase - neutral	The phase-neutral voltage will be monitored and all subsequent parameters concerning voltage monitoring "mains" are referred to this value (VL-N).
			All	The phase-phase and phase-neutral voltage will be monitored and all subsequent parameters concerning voltage monitoring

ID	Parameter	CL	Setting range [Default]	Description
				<p>"mains" are referred to this value (VL-L & VL-N).</p> <p>This setting is only effective if "Mains voltage measuring" (parameter ↩> 1853) is configured to "3Ph 4W".</p>
				<p>Notes</p> <p>WARNING: This parameter influences the protective functions.</p> <p>Please be aware that if "Mains voltage monitoring" (parameter ↩> 1771) is configured to "All" and the function ↩> "4.5.1.2.2 Generator Undervoltage (Level 1 & 2) ANSI# 27" is used, that this function only monitors "Phase - neutral".</p>
2801	Mains settling time	2	0 to 9999 s [20 s]	<p>To end the emergency operation, the monitored mains must be within the configured operating parameters without interruption for the minimum period of time set with this parameter without interruption.</p> <p>This parameter permits delaying the switching of the load from the generator to the mains.</p> <p>The remaining time is displayed. During this time the display indicates "Mains settling".</p>

4.5.3.2 Blocking of Mains Protection

General notes

The operator can deactivate the mains monitoring features and the decoupling function. A dedicated LogicsManager is installed to disable all mains monitoring and the decoupling function.



Already latched alarms (self acknowledge = No) are not removed from the alarm list by this function.

Following functions are blocked:

- Mains decoupling
- Mains over frequency 1&2
- Mains under frequency 1&2
- Mains over voltage 1&2

- Mains under voltage 1&2
- Mains voltage increase (10 minutes average value)
- Mains Time-dependent Voltage (FRT)
- Mains Q(V) Monitoring
- Mains phase shift
- Mains df/dt

ID	Parameter	CL	Setting range [Default]	Description
15159	Disable mns.mon.	2	Determined by LogicsManager 87.72 [(0 & 1) & 1] t_{ON} = 0.00; t_{OFF} = 0.00] = 11461	Switch to disable <ul style="list-style-type: none"> • all mains monitoring functions and • the mains decoupling function.

4.5.3.3 Mains Operating Ranges

4.5.3.3.1 General Mains Operating Range

General notes



The mains operating voltage/frequency parameters are used to trigger mains failure conditions and activate an emergency run.

The mains values must be within this ranges to synchronize the mains circuit breaker. It is recommended to configure the operating limits within the monitoring limits.

Example

If the mains rated voltage is 400 V, the upper voltage limit is 110 % (of the mains rated voltage, i.e. 440 V), and the hysteresis for the upper voltage limit is 5 % (of the mains rated voltage, i.e. 20 V), the mains voltage will be considered as being out of the operating limits as soon as it exceeds 440 V and will be considered as being within the operating limits again as soon as it falls below 420 V (440 V – 20 V).

If the rated system frequency is 50 Hz, the lower frequency limit is 90 % (of the rated system frequency, i.e. 45 Hz), and the hysteresis for the lower frequency limit is 5 % (of the rated system frequency, i.e. 2.5 Hz), the mains frequency will be considered as being out of the operating limits as soon as it falls below 45 Hz and will be considered as being within the operating limits again as soon as it exceeds 47.5 Hz (45 Hz + 2.5 Hz).

ID	Parameter	CL	Setting range [Default]	Description
5810	Upper voltage limit	2	100 to 150% [110%]	The maximum permissible positive deviation of the mains voltage from the mains rated

ID	Parameter	CL	Setting range [Default]	Description
				<p>voltage (parameter ↔ 1768) is configured here.</p> <p>This value may be used as a voltage limit switch. The conditional state of this switch may be used as a command variable for the LogicsManager (02.09).</p>
5814	Hysteresis upper voltage limit	2	0 to 50% [2%]	If the mains voltage has exceeded the limit configured in parameter ↔ 5810 , the voltage must fall below the limit and the value configured here, to be considered as being within the operating limits again.
5811	Lower voltage limit	2	50 to 100% [90%]	<p>The maximum permissible negative deviation of the mains voltage from the mains rated voltage (parameter ↔ 1768) is configured here.</p> <p>This value may be used as a voltage limit switch. The conditional state of this switch may be used as a command variable for the LogicsManager (02.09).</p>
5815	Hysteresis lower voltage limit	2	0 to 50% [2%]	If the mains voltage has fallen below the limit configured in parameter ↔ 5811 , the voltage must exceed the limit and the value configured here, to be considered as being within the operating limits again.
5812	Upper frequency limit	2	66.7 ¹ to 150.0% [110.0%]	<p>The maximum permissible positive deviation of the mains frequency from the rated system frequency (parameter ↔ 1750) is configured here.</p> <p>This value may be used as a frequency limit switch. The conditional state of this switch may be used as a command variable for the LogicsManager (02.10).</p>
				<p>Notes</p> <p>¹ The lowest measurable frequency is 40 Hz. 66.7 % of 60 Hz is 40 Hz. Equivalent for 50 Hz don't go below 80 %.</p>
5816	Hyst. upper frequency limit	2	0.0 to 50.0% [0.5%]	If the mains frequency has exceeded the limit configured in parameter ↔ 5812 , the frequency must fall below the limit and the value configured here, to be considered as being within the operating limits again.
5813	Lower frequency limit	2	66.7 ¹ to 100.0%	The maximum permissible negative deviation of the mains

4 Configuration

4.5.3.3.2 Reconnecting Mains Operating Range

ID	Parameter	CL	Setting range [Default]	Description
			[90.0%]	frequency from the rated system frequency (parameter ↪ 1750) is configured here. This value may be used as a frequency limit switch. The conditional state of this switch may be used as a command variable for the LogicsManager (02.10). Notes ¹ The lowest measurable frequency is 40 Hz. 66.7 % of 60 Hz is 40 Hz. Equivalent for 50 Hz don't go below 80 %.
5817	Hyst. lower frequency limit	2	0.0 to 50.0% [0.5%]	If the mains frequency has exceeded the limit configured in parameter ↪ 5813 , the frequency must raise above the limit and the value configured here, to be considered as being within the operating limits again.

4.5.3.3.2 Reconnecting Mains Operating Range

Introduction

After mains decoupling from the power generation device, with under-/over frequency or under-/over voltage, the automatic reconnection to the grid after the mains settling time is only possible, if the mains is within the following operation ranges.

The operation ranges for mains reconnecting uses the voltages according to the configured mains voltage monitoring (ID 1771 Mains voltage monitoring, phase-phase/phase-neutral/All). Only if all considered voltages are back in band the synchronization to mains will be executed.

ID	Parameter	CL	Setting range [Default]	Description
5818	Upper voltage limit	2	100 to 150% [105%]	The maximum permissible positive deviation of the mains voltage from the mains rated voltage after mains decoupling.
5819	Lower voltage limit	2	50 to 100% [95%]	The maximum permissible negative deviation of the mains voltage from the mains rated voltage after mains decoupling.
5821	Upper frequency limit	2	66.7 to 150.0% [100.2%]	The maximum permissible positive deviation of the mains voltage from the mains rated voltage after mains decoupling.
5822	Lower frequency limit	2	66.7 to 100.0%	The maximum permissible negative deviation of the mains

ID	Parameter	CL	Setting range [Default]	Description
			[99.8%]	voltage from the mains rated voltage after mains decoupling.

4.5.3.4 Mains Decoupling

General notes

The mains decoupling function is intended for use in a mains parallel operation and monitors a series of subordinate mains protection thresholds. If a threshold is exceeded, the genset control initiates a breaker opening and separates the generator(s) from the mains at the defined breaker.

The following thresholds are monitored:

- Overfrequency level 2 (↳ “4.5.1.3.2 Generator Overfrequency (Level 1 & 2) ANSI# 81O”)
- Underfrequency level 2 (↳ “4.5.3.6 Mains Underfrequency (Level 1 & 2) ANSI# 81U”)
- Overvoltage level 2 (↳ “4.5.1.2.1 Generator Overvoltage (Level 1 & 2) ANSI# 59”)
- Undervoltage level 2 (↳ “4.5.1.2.2 Generator Undervoltage (Level 1 & 2) ANSI# 27”)
- Mains phase shift / df/dt (ROCOF) (↳ “4.5.3.12 Change Of Frequency”)

If one of these protective functions is triggered, the display indicates "Mains decoupling" (the logical command variable "07.25" will be enabled) and the active level 2 alarm.



The mains decoupling function is optimized on the both relay outputs "GCB open" and "MCB open". In case of using a free relay output in conjunction with the command variable 07.25 an additional delay time of up to 20 ms is to consider.

Managing Breaker Open alarm

When the mains decoupling function detects a breaker open failure, the according breaker alarm will be triggered as long the monitoring function is activated. Additionally in cases where the decoupling mode has to change over to the other breaker, (GCB@MCB, MCB@GCB), the alarm text “Decoupling GCB«MCB” is indicated. The breaker open alarm already occurs after the mains decoupling feedback delay (refer to ID ↳ 3113).

ID	Parameter	CL	Setting range [Default]	Description
12922	Ext. mns.decoupl. (External mains decoupling)	2	Determined by LogicsManager 86.27 [(0 & 1) & 1]	The unit may be configured to decouple from the mains when commanded by an external device.

ID	Parameter	CL	Setting range [Default]	Description
				Once the conditions of the LogicsManager have been fulfilled, an external mains failure is issued.
				Notes For information on the LogicsManager and its default settings see ↩ "9.3.1 LogicsManager Overview".
12942	Enable mains decoupl. (Enable mains decoupling)	2	Determined by LogicsManager 87.31 [(02.02 & 1) & 1]	Once the conditions of the LogicsManager have been fulfilled, the mains decoupling function is enabled.
				Notes For information on the LogicsManager and its default settings see ↩ "9.3.1 LogicsManager Overview".
3110	Mains decoupling	2	Off	Mains decoupling monitoring is disabled.
			[GCB]	Mains decoupling is carried out according to the following parameters. If one of the subordinate monitoring functions is triggered, the GCB will be opened. If the unit is operated in parallel with the mains and the MCB opens, the GCB will be closed again.
			GCB->MCB	Mains decoupling is carried out according to the following parameters. If one of the subordinate monitoring functions is triggered, the GCB will be opened. If the reply "GCB open" is not present within the delay configured in parameter ↩ 3113, the MCB will be opened as well.
			MCB	Mains decoupling is carried out according to the following parameters. If one of the subordinate monitoring functions is triggered, the MCB will be opened.
			MCB->GCB	Mains decoupling is carried out according to the following parameters. If one of the subordinate monitoring functions is triggered, the MCB will be opened. If the reply "MCB open" is not present within the delay configured in parameter ↩ 3113, the GCB will be opened as well.
			GCB/MCB by LM	Mains decoupling is carried out. If one of the subordinate monitoring functions is triggered, a breaker will be opened, which is determined by the LogicsManager

ID	Parameter	CL	Setting range [Default]	Description
				equation " ↪ 15160 LM mains decoupling MCB". If it's status is TRUE, the MCB will be opened. If it's status is FALSE, the GCB will be opened.
15160	Mains decoupl.MCB	2	Determined by LogicsManager 87.73 [(0 & 1) & 1]	FALSE: If the decoupling is triggered, the GCB will be opened. TRUE: If the decoupling is triggered, the MCB will be opened. Only available in Mains decoupling mode "GCB/MCB by LM".
3113	Mns. decoupling feedback delay	2	0.2 to 99.9 s [0.4 s]	If the open signal from the respective circuit breaker cannot be detected within the time configured here, the mains decoupling function performs the action as configured in parameter ↪ 3110.
3111	Alarm class	2	Class A, Class B, Class C, Class D, Class E, Class F , Control [Class B]	Each limit may be assigned an independent alarm class that specifies what action should be taken when the limit is surpassed.
				Notes For additional information refer to ↪ "9.5.4 Alarm Classes".
3112	Self acknowledge	2	Yes	The control automatically clears the alarm if the fault condition is no longer detected.
			[No]	The control does not automatically reset the alarm when the fault condition is no longer detected. The alarm must be acknowledged and reset by manually pressing the appropriate buttons or by activating the LogicsManager output "External acknowledgment" (via a discrete input or via an interface).
8848	Mns.decoupling by overfreq.1	2		The mains overvoltage 1 alarm can be linked to the mains decoupling function, if required.
			On	The mains overvoltage 1 trip is linked to the mains decoupling function with all its consequences.
			[Off]	The mains overvoltage 1 trip is ignored in the mains decoupling function.
				Notes It is recommended to configure the operating limits (parameter ↪ 5810 to ↪ 5817) within the monitoring limits.

ID	Parameter	CL	Setting range [Default]	Description
8845	Mns.decoupling by overvolt.1	2		The mains overvoltage 1 alarm can be linked to the mains decoupling function, if required.
			On	The mains overvoltage 1 trip is linked to the mains decoupling function with all its consequences.
			[Off]	The mains overvoltage 1 trip is ignored in the mains decoupling function.
				Notes It is recommended to configure the operating limits (parameter ↩> 5810 to ↩> 5817) within the monitoring limits.
2423	Mains decoupling by pole slip	2	On	The QV monitoring function is linked to the mains decoupling function with all its consequences and is assigned to "Delay step 1" (parameter ↩> 3283).
			[Off]	The QV monitoring function is ignored in the mains decoupling function.
3296	Mains decoupling by QV	2	On	The QV monitoring function is linked to the mains decoupling function with all its consequences and is assigned to "Delay step 1" (parameter ↩> 3283).
			[Off]	The QV monitoring function is ignored in the mains decoupling function.
4989	Mns.decoupl.by time-dep.volt.	2	On	Time-dependent voltage monitoring does cause a decoupling.
			[Off]	Time-dependent voltage monitoring does not cause a decoupling.
8847	Mns.decoupling by underfreq.1	2		The mains undervoltage 1 alarm can be linked to the mains decoupling function, if required.
			On	The mains undervoltage 1 trip is linked to the mains decoupling function with all its consequences.
			[Off]	The mains undervoltage 1 trip is ignored in the mains decoupling function.
				Notes It is recommended to configure the operating limits (parameter ↩> 5810 to ↩> 5817) within the monitoring limits.
8844	Mns.decoupling by undervolt.1	2		The mains undervoltage 1 alarm can be linked to the mains decoupling function, if required.

ID	Parameter	CL	Setting range [Default]	Description
			On	The mains undervoltage 1 trip is linked to the mains decoupling function with all its consequences.
			[Off]	The mains undervoltage 1 trip is ignored in the mains decoupling function.
				Notes It is recommended to configure the operating limits (parameter ↩ 5810 to ↩ 5817) within the monitoring limits.
8808	Mains decoupling volt.incr.	2	On	Voltage increase monitoring does cause a decoupling.
			[Off]	Voltage increase monitoring does not cause a decoupling.
1733	Test	2	On	Activates a test mode which allows a comfortable mains decoupling test.
			[Off]	Deactivates the test mode. Mains decoupling is working normal.
				Notes When the test mode is activated a mains decoupling according to the parametrization is triggered, once a mains failure is detected. Thereby the states of things of the breaker reply are irrelevant. A retriggering of the mains decoupling can be performed after 0.5 s + "Mns. decoupling feedback delay" (parameter ↩ 3113) without leaving the test mode. As long as the codelevel is ≥ 2 it is possible to switch-off the test mode manually. The test mode switches off automatically after one hour since having turned on or after switching on the operation magnet (engine should start).

4.5.3.4.1 Setup Grid Code AR--4105

General notes

The German Grid Code VDE-AR-N 4105 instructs the handling of electrical energy sources running parallel to the low voltage grid. This rule has an impact with some items on the genset control. A more detailed description relating to that VDE rule is done through the separated application note "easYgen-3000_VDE-AR-N 4105".

Here are some functions which have to be covered according to the 4105 rule:

- The mains decoupling is executed through following monitors:
 - Mains under voltage $V <$

- Mains over voltage $V >$
- Mains under frequency $f <$
- Mains over frequency $f >$
- Recognizing isolation operation (other decoupling argument)
 - Phase shift OR
 - df/dt
- Button for Testing the Decoupling Facility
- Single-failure-security including self-monitoring

The VDE-AR-N 4105 demands a Single-failure-proof of the mains decoupling function. That means that the decoupling of the generator from the mains must be always ensured, even if a single element in the system fails. So the system must contain two circuit breakers with two independent monitoring functions acting individually on each breaker. From the perspective of the network provider that rule pursues the mains protection but not the availability of the electrical source, so in case of doubt the generator should be decoupled from mains.

Woodward solves this requirement with the use of a minimum of two units acting as a system (for example two easYgens or an easYgen and an LS-5 with 4105 functionality). The system allows incorporating more units, so that the availability of the generator can still be increased.

The demanded two breakers in series are realized through the use of a GCB and a MCB. If only a GCB is available, the customer must install another circuit breaker in addition.

An important item of the VDE-AR-N 4105 is the Single-Failure-Diagnostic, at which a minimum of two units exchange their measurement data and settings over communication interface (usually CANbus). This allows determining, if the Single-Failure-Proof is lost and the unit can issue an alarm.



Using Ethernet?

To use Ethernet communication interface for Single-failure-proof it is mandatory that load-share is using Ethernet, too. For interface selection refer to [↳ "4.4.4.3.5 Load-Share Interface"](#).

Enable 4105 monitoring

Monitoring according VDE AR-N 4105 per default is [Off]. It can be enabled via ToolKit [Configure monitoring / Mains / Other monitoring / Setup VDE-AR-N 4105] or via Menu (see screen [↳ Fig. 223](#)).

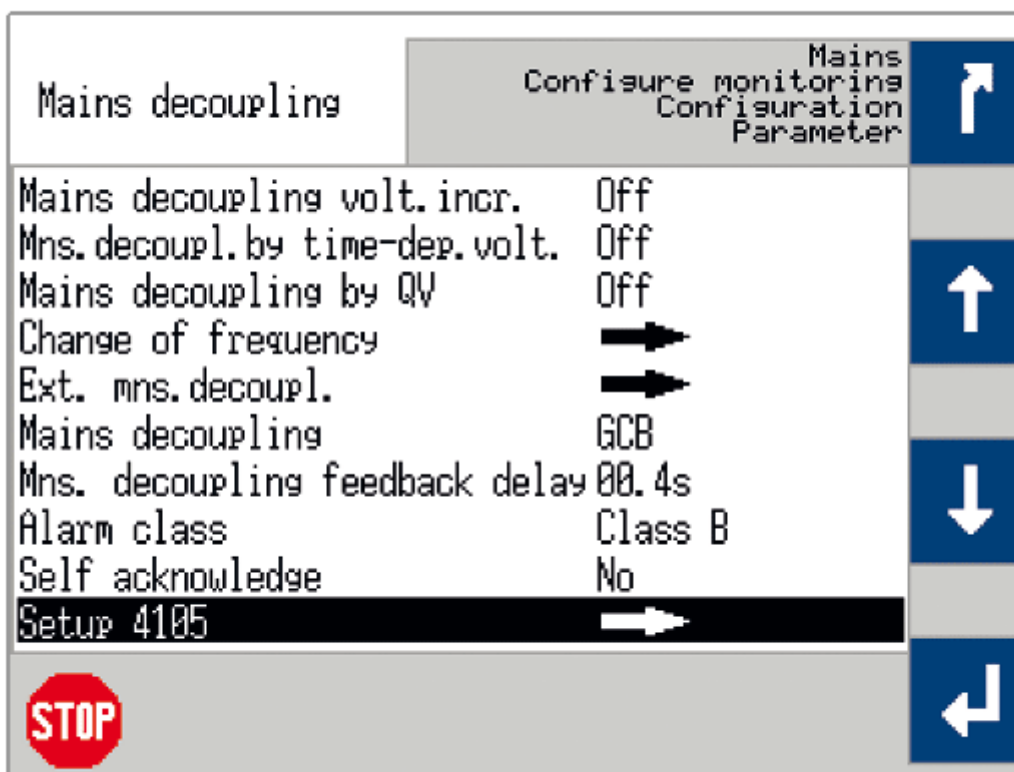

Fig. 223: Select mains decoupling 4105

Monitoring according AR--4105

ID	Parameter	CL	Setting range [Default]	Description
3297	Monitoring	2	[Off]	The diagnostic function is disabled, no related monitoring is executed.
			CAN #1, CAN #3, Ethernet	If the diagnostic function is enabled, the related messages can be received via CAN 1, CAN 3 or Ethernet. Notes The following alarms can be triggered: <ul style="list-style-type: none"> • Missing member 4105 • Para. alignment 4105 • Meas.difference 4105
3298	Monitoring mode	2	Single	The diagnostic function is related to one partner unit.
			[Multi]	The diagnostic function is executed with according partner units.

ID	Parameter	CL	Setting range [Default]	Description
3299	Device number partner	2	[01] 01 to 64	The device ID of the expected partner unit. This configuration is only valid, if the mode 'single' is enabled.
1828	Voltage difference	2	[4.0%] 2.0 to 9.9%	This is the voltage measurement tolerance for all participating 4105 partners relating to the mains rated voltage measurement (refer to ID 1768). This is a part within the 4105 diagnostic.
1836	Frequency difference	2	[1.0%] 0.5 to 9.9%	This is the frequency measurement tolerance for all participating 4105 partners relating to the system rated frequency measurement. (refer to ID 1750). This is a part within the 4105 diagnostic.

Monitoring Missing Member AR--4105

ID	Parameter	CL	Setting range [Default]	Description
5125	Alarm class	2	Class A, Class B, Class C, Class D, Class E, Class F , Control [Class C]	The alarm class specifies what action should be taken in case of missing communication with devices(s) being member(s) of the AR--4105 system.
			Notes For additional information refer to "9.5.4 Alarm Classes" .	
5126	Self acknowledge	2	Yes	The control automatically clears the alarm if the fault condition is no longer detected.
			[No]	The control unit does not automatically reset the alarm when the fault condition is no longer detected. The alarm must be acknowledged and reset by manually pressing the appropriate buttons or by activating the LogicsManager output "External acknowledgment" (via a discrete input or via an interface).

Monitoring Parameter Alignment VDE AR--4105

The following parameters are compared for monitoring its alignment:

Control	Parameter ID	Parameter
Mains Decoupling	3110	Mains Decoupling
Overfrequency level 2	2856	Monitoring
	2860	Limit

Control	Parameter ID	Parameter
	2861	Delay
Underfrequency level 2	2906	Monitoring
	2910	Limit
	2911	Delay
Overvoltage level 2	2956	Monitoring
	2960	Limit
	2961	Delay
Undervoltage level 2	3006	Monitoring
	3010	Limit
	3011	Delay
Mains voltage increase	8806	Monitoring
	8808	Mains decoupling volt.incr.
	8807	Limit
Change of frequency	3058	Change of frequency
	3054	Phase shift: Limit 1-phase
	3055	Phase shift: Limit 3-phase
	3104	Limit (df/dt)
	3105	Delay (df/dt)
Disable mains monitoring	15159	Set TRUE
		Notes In applications with LS-5, this LogicsManager must be permanent FALSE. Otherwise the LS-5 parameter alignment alarm will remain.

Table 76: VDE 4105 alignment: Supervised parameters

ID	Parameter	CL	Setting range [Default]	Description
5131	Alarm class	2	Class A, Class B, Class C, Class D, Class E, Class F , Control	The alarm class specifies what action should be taken if the parameter alignment between the communication devices(s) of the AR--4105 system is active.
			[Class C]	
5132	Self acknowledge	2	Yes	The control automatically clears the alarm if the fault condition is no longer detected.
			[No]	

4 Configuration

4.5.3.4.2 Setup Grid Code BDEW (medium voltage guideline)

ID	Parameter	CL	Setting range [Default]	Description
				The alarm must be acknowledged and reset by manually pressing the appropriate buttons or by activating the LogicsManager output "External acknowledgment" (via a discrete input or via an interface).

Table 77: VDE 4105 alignment: Monitoring

Monitoring Measurement Difference AR--4105

ID	Parameter	CL	Setting range [Default]	Description
5137	Alarm class	2	Class A, Class B, Class C, Class D, Class E, Class F , Control [Class C]	<p>The alarm class specifies what action should be taken if the measurement difference (frequency, \hookrightarrow 1836 or voltage, \hookrightarrow 1828) between the communication devices(s) of the AR--4105 system differ more than allowed.</p> <p>Notes</p> <p>For additional information refer to \hookrightarrow "9.5.4 Alarm Classes".</p>
5138	Self acknowledge	2	Yes [No]	<p>The control automatically clears the alarm if the fault condition is no longer detected.</p> <p>The control unit does not automatically reset the alarm when the fault condition is no longer detected.</p> <p>The alarm must be acknowledged and reset by manually pressing the appropriate buttons or by activating the LogicsManager output "External acknowledgment" (via a discrete input or via an interface).</p>

4.5.3.4.2 Setup Grid Code BDEW (medium voltage guideline)

The BDEW Grid Code instructs the handling of electrical energy sources running parallel to the medium voltage grid. This rule has an impact with some items on the genset control. A more detailed description relating to that BDEW technical guideline can be ordered directly by the BDEW Germany. With easYgen-3000... genset control series functions which have to be covered according to this BDEW rule are supported.

The mains decoupling is executed through following monitors:

- Mains under voltage V<
- Mains under voltage V<<

- Mains over voltage $V >$
- Mains over voltage $V >>$
- Mains under frequency $f <$
- Mains over frequency $f >$
- Q(V) Monitoring
- Mains Time-Dependent Voltage (FRT)

The Change of frequency monitors (vector/phase shift or df/dt) is not directly required by BDEW. These monitors are depending on the according network providers.

Other functions related to the BDEW guideline:

- Frequency Depending Derating Of Power. Refer to [↗](#) "4.4.4.5.5 Active Power - Frequency Function $P(f)$ " for details.
- Reactive Power Control, alternatively:
 - Power Factor Control. Refer to [↗](#) "4.4.4.2 Power Factor Control" for details.
 - Power Factor Characteristic. Refer to [↗](#) "4.4.4.2 Power Factor Control" for details.

4.5.3.5 Mains Overfrequency (Level 1 & 2) ANSI# 810

General notes

There are two overfrequency alarm levels available in the control. Both alarms are definite time alarms and are illustrated in the figure below. The figure diagrams a frequency trend and the associated pickup times and length of the alarms. Monitoring of the frequency is accomplished in two steps.



If this protective function is triggered, the display indicates "Mains overfreq. 1" or "Mains overfreq. 2" and the logical command variable "07.06" or "07.07" will be enabled.

Refer to [↗](#) "9.1.1 Triggering Characteristics" for the triggering characteristic of this monitoring function.

ID	Parameter	CL	Setting range [Default]	Description
2850 2856	Monitoring	2	[On]	Overfrequency monitoring is carried out according to the following parameters. Monitoring is performed at two levels. Both values may be configured independent from each other (prerequisite: limit 1 < Level 2 limit).
			Off	Monitoring is disabled for Level 1 limit and/or Level 2 limit.

4 Configuration

4.5.3.5 Mains Overfrequency (Level 1 & 2) ANSI# 810

ID	Parameter	CL	Setting range [Default]	Description
2854 2860	Limit	2	100.0 to 140.0% 2854: [100.4%] 2860: [102.0%] (Reset Delay: 80 ms)	<p>The percentage values that are to be monitored for each threshold limit are defined here.</p> <p>If this value is reached or exceeded for at least the delay time without interruption, the action specified by the alarm class is initiated.</p> <p>Notes</p> <p>This value refers to the System rated frequency (parameter 1750).</p>
2965 3016	Hysteresis	2	0.00 to 10.00% 2965: [0.10%] 3016: [0.10%]	<p>If the mains frequency has exceeded the configured limit , the frequency must fall below the limit and the value configured here, to reset the alarm.</p> <p>Notes</p> <p>This value refers to the System rated frequency (parameter 1750).</p>
2855 2861	Delay	2	0.00 to 99.99 s [0.06 s]	<p>If the monitored mains frequency value exceeds the threshold value for the delay time configured here, an alarm will be issued.</p> <p>Notes</p> <p>If the monitored mains frequency falls below the threshold (minus the hysteresis) before the delay expires the time will be reset.</p>
2851 2857	Alarm class	2	Class A, Class B, Class C, Class D, Class E, Class F , Control 2851: [Class A] 2857: [Class B]	<p>Each limit may be assigned an independent alarm class that specifies what action should be taken when the limit is surpassed.</p> <p>Notes</p> <p>For additional information refer to "9.5.4 Alarm Classes"</p>
2852 2858	Self acknowledge	2	[Yes] No	<p>The control unit automatically clears the alarm if the fault condition is no longer detected.</p> <p>The control unit does not automatically reset the alarm when the fault condition is no longer detected.</p> <p>The alarm must be acknowledged and reset by manually pressing the appropriate buttons or by activating the LogicsManager output "External acknowledgment" (via a discrete input or via an interface).</p>

ID	Parameter	CL	Setting range [Default]	Description
2853 2859	Enabled	4	[Always]	Monitoring for this fault condition is continuously enabled.
87.70 LM:Eng.mon			Monitoring for fault conditions is not performed until engine monitoring is enabled. This is determined through the LogicsManager equation "Release engine monitoring".	
For xx = 1 to 32: 96.{xx} LM: Flag{xx}			The monitoring is executed, if the LogicsManager "Flag {xx}" is TRUE. Example: 96.01 LM: Flag 1, 96.02 LM: Flag 2, ..., 96.32 LM: Flag 32	

4.5.3.6 Mains Underfrequency (Level 1 & 2) ANSI# 81U

General notes

There are two underfrequency alarm levels available in the control. Both alarms are definite time alarms and are illustrated in the figure below. The figure diagrams a frequency trend and the associated pickup times and length of the alarms. Monitoring of the frequency is performed in two steps.



If this protective function is triggered, the display indicates "Mains underfreq. 1" or "Mains underfreq. 2" and the logical command variable "07.08" or "07.09" will be enabled.

Refer to [9.1.1 Triggering Characteristics](#) for the triggering characteristic of this monitoring function.

ID	Parameter	CL	Setting range [Default]	Description
2900 2906	Monitoring	2	[On]	Underfrequency monitoring is carried out according to the following parameters. Monitoring is performed at two levels. Both values may be configured independent from each other (prerequisite: Level 1 > Level 2).
Off			Monitoring is disabled for limit 1 and/or Level 2 limit.	
2904 2910	Limit	2	50.0 to 140.0% 2904: [99.6%] 2910: [98.0%] (Reset Delay: 80 ms)	The percentage values that are to be monitored for each threshold limit are defined here. If this value is reached or fallen below for at least the delay time without interruption, the action

4 Configuration

4.5.3.6 Mains Underfrequency (Level 1 & 2) ANSI# 81U

ID	Parameter	CL	Setting range [Default]	Description
				<p>specified by the alarm class is initiated.</p> <p>Notes</p> <p>This value refers to the System rated frequency (parameter 1750).</p>
2998 3017	Hysteresis	2	0.00 to 10.00% 2998: [0.10%] 3017: [0.10%]	<p>If the mains frequency has fallen below the configured limit, the frequency must exceed the limit and the value configured here, to reset the alarm.</p> <p>Notes</p> <p>This value refers to the System rated frequency (parameter 1750).</p>
2905 2911	Delay	2	0.00 to 99.99 s 2905: [1.50 s] 2911: [0.06 s]	<p>If the monitored mains frequency value falls below the threshold value for the delay time configured here, an alarm will be issued.</p> <p>Notes</p> <p>If the monitored mains frequency exceeds the threshold (plus the hysteresis) again before the delay expires the time will be reset.</p>
2901 2907	Alarm class	2	Class A, Class B, Class C, Class D, Class E, Class F , Control 2901: [Class A] 2907: [Class B]	<p>Each limit may be assigned an independent alarm class that specifies what action should be taken when the limit is surpassed.</p> <p>Notes</p> <p>For additional information refer to "9.5.4 Alarm Classes"</p>
2902 2908	Self acknowledge	2	[Yes] No	<p>The control unit automatically clears the alarm if the fault condition is no longer detected.</p> <p>The control unit does not automatically reset the alarm when the fault condition is no longer detected.</p> <p>The alarm must be acknowledged and reset by manually pressing the appropriate buttons or by activating the LogicsManager output "External acknowledgment" (via a discrete input or via an interface).</p>
2903 2909	Enabled	4	[Always] 87.70 LM:Eng.mon	<p>Monitoring for this fault condition is continuously enabled.</p> <p>Monitoring for fault conditions is not performed until engine monitoring is enabled. This is</p>

ID	Parameter	CL	Setting range [Default]	Description
				determined through the LogicsManager equation "Release engine monitoring".
			For $xx = 1$ to 32: 96.{xx} LM: Flag{xx}	The monitoring is executed, if the LogicsManager "Flag {xx}" is TRUE. Example: 96.01 LM: Flag 1, 96.02 LM: Flag 2, ..., 96.32 LM: Flag 32

4.5.3.7 Mains Overvoltage (Level 1 & 2) ANSI# 59

General notes

Voltage is monitored depending on parameter "Mains voltage measuring" (parameter [1853](#)). There are two overvoltage alarm levels available in the control. Both alarms are definite time alarms and are illustrated in the figure below. The figure diagrams a frequency trend and the associated pickup times and length of the alarms. Monitoring of the voltage is done in two steps.



If this protective function is triggered, the display indicates "Mains overvoltage 1" or "Mains overvoltage 2" and the logical command variable "07.10" or "07.11" will be enabled.

Refer to [9.1.1 Triggering Characteristics](#) for the triggering characteristic of this monitoring function.

ID	Parameter	CL	Setting range [Default]	Description
2950 2956	Monitoring	2	[On]	Overvoltage monitoring is carried out according to the following parameters. Monitoring is performed at two levels. Both values may be configured independent from each other (prerequisite: limit 1 < Level 2 limit).
			Off	Monitoring is disabled for Level 1 limit and/or Level 2 limit.
2954 2960	Limit	2	50.0 to 150.0% 2954: [108.0%] 2960: [110.0%] (Reset Delay: 80 ms)	The percentage values that are to be monitored for each threshold limit are defined here. If this value is reached or exceeded for at least the delay time without interruption, the action specified by the alarm class is initiated.
				Notes

4 Configuration

4.5.3.7 Mains Overvoltage (Level 1 & 2) ANSI# 59

ID	Parameter	CL	Setting range [Default]	Description
				This value refers to the Mains rated voltage (parameter ↩➤ 1768).
2964 3014	Hysteresis	2	00.00 to 20.00 % 2964: [1.50 %] 3014: [1.50 %]	<p>If the mains voltage has exceeded the configured limit , the voltage must fall below the limit and the value configured here, to reset the alarm.</p> <p>Notes</p> <p>This value refers to the Mains rated voltage (parameter ↩➤ 1768).</p>
2955 2961	Delay	2	0.00 to 999.00 s 2955: [1.50 s] 2961: [0.06 s]	<p>If the monitored mains voltage exceeds the threshold value for the delay time configured here, an alarm will be issued.</p> <p>Notes</p> <p>If the monitored mains voltage falls below the threshold (minus the hysteresis) before the delay expires the time will be reset.</p>
2951 2957	Alarm class	2	Class A, Class B, Class C, Class D, Class E, Class F , Control 2951: [Class A] 2957: [Class B]	<p>Each limit may be assigned an independent alarm class that specifies what action should be taken when the limit is surpassed.</p> <p>Notes</p> <p>For additional information refer to ↩➤ "9.5.4 Alarm Classes"</p>
2952 2958	Self acknowledge	2	[Yes] No	<p>The control unit automatically clears the alarm if the fault condition is no longer detected.</p> <p>The control unit does not automatically reset the alarm when the fault condition is no longer detected.</p> <p>The alarm must be acknowledged and reset by manually pressing the appropriate buttons or by activating the LogicsManager output "External acknowledgment" (via a discrete input or via an interface).</p>
2953 2959	Enabled	4	[Always] 87.70 LM:Eng.mon <i>For xx = 1 to 32:</i> 96.{xx}	<p>Monitoring for this fault condition is continuously enabled.</p> <p>Monitoring for fault conditions is not performed until engine monitoring is enabled. This is determined through the LogicsManager equation "Release engine monitoring".</p> <p>The monitoring is executed, if the LogicsManager "Flag {xx}" is TRUE.</p>

ID	Parameter	CL	Setting range [Default]	Description
			LM: Flag{xx}	Example: 96.01 LM: Flag 1, 96.02 LM: Flag 2, ..., 96.32 LM: Flag 32
8845	Mns.decoupling by overvolt.1	2		The mains overvoltage 1 alarm can be linked to the mains decoupling function, if required.
			On	The mains overvoltage 1 trip is linked to the mains decoupling function with all its consequences.
			[Off]	The mains overvoltage 1 trip is ignored in the mains decoupling function.
				Notes It is recommended to configure the operating limits (parameter ↩ 5810 to ↩ 5817) within the monitoring limits.

4.5.3.8 Mains Undervoltage (Level 1 & 2) ANSI# 27

General notes

Voltage is monitored depending on parameter "Mains voltage measuring" (parameter [↩ 1853](#)). There are two undervoltage alarm levels available in the control. Both alarms are definite time alarms and are illustrated in the figure below. The figure diagrams a frequency trend and the associated pickup times and length of the alarms. Monitoring of the voltage is done in two steps.



If this protective function is triggered, the display indicates "Mains undervoltage 1" or "Mains undervoltage 2" and the logical command variable "07.12" or "07.13" will be enabled.

Refer [↩ 9.1.1 Triggering Characteristics](#) for the triggering characteristic of this monitoring function.

ID	Parameter	CL	Setting range [Default]	Description
3000 3006	Monitoring	2	[On]	Undervoltage monitoring is carried out according to the following parameters. Monitoring is performed at two levels. Both values may be configured independent from each other (prerequisite: Level 1 limit < Level 2 limit).
			Off	Monitoring is disabled for Level 1 limit and/or Level 2 limit.
3004 3010	Limit	2	10.0 to 150.0% 3004: [92.0%]	The percentage values that are to be monitored for each threshold limit are defined here.

4 Configuration

4.5.3.8 Mains Undervoltage (Level 1 & 2) ANSI# 27

ID	Parameter	CL	Setting range [Default]	Description
			3010: [90.0%] (Reset Delay: 80 ms)	<p>If this value is reached or exceeded for at least the delay time without interruption, the action specified by the alarm class is initiated.</p> <p>Notes</p> <p>This value refers to the "Mains rated voltage" (parameter ↩➤ 1768).</p> <p>Minimum value follows BDEW requirement.</p>
2997 3015	Hysteresis	2	00.00 to 20.00% 2997: [1.50%] 3015: [1.50%]	<p>If the mains voltage has fallen below the configured limit, the voltage must exceed the limit and the value configured here, to reset the alarm.</p> <p>Notes</p> <p>This value refers to the "Mains rated voltage" (parameter ↩➤ 1768).</p>
3005 3011	Delay	1	0.00 to 99.99 s 3005: [1.50 s] 3011: [0.06 s]	<p>If the monitored mains voltage falls below the threshold value for the delay time configured here, an alarm will be issued.</p> <p>Notes</p> <p>If the monitored mains voltage exceeds the threshold (plus the hysteresis) again before the delay expires the time will be reset.</p>
3001 3007	Alarm class	2	Class A, Class B, Class C, Class D, Class E, Class F , Control 3001: [Class A] 3007: [Class B]	<p>Each limit may be assigned an independent alarm class that specifies what action should be taken when the limit is surpassed.</p> <p>Notes</p> <p>For additional information refer to ↩➤ "9.5.4 Alarm Classes"</p>
3002 3008	Self acknowledge	2	[Yes] No	<p>The control unit automatically clears the alarm if the fault condition is no longer detected.</p> <p>The control unit does not automatically reset the alarm when the fault condition is no longer detected.</p> <p>The alarm must be acknowledged and reset by manually pressing the appropriate buttons or by activating the LogicsManager output "External acknowledgment" (via a discrete input or via an interface).</p>
3003	Enabled	4	[Always]	Monitoring for this fault condition is continuously enabled.

ID	Parameter	CL	Setting range [Default]	Description
3009			87.70 LM:Eng.mon	Monitoring for fault conditions is not performed until engine monitoring is enabled. This is determined through the LogicsManager equation "Release engine monitoring".
			For xx = 1 to 32: 96.{xx} LM: Flag{xx}	The monitoring is executed, if the LogicsManager "Flag {xx}" is TRUE. Example: 96.01 LM: Flag 1, 96.02 LM: Flag 2, ..., 96.32 LM: Flag 32
8844	Mns.decoupling by undervolt.1	2		The mains undervoltage 1 alarm can be linked to the mains decoupling function, if required.
			On	The mains undervoltage 1 trip is linked to the mains decoupling function with all its consequences.
			[Off]	The mains undervoltage 1 trip is ignored in the mains decoupling function.
				Notes It is recommended to configure the operating limits (parameter ↩ 5810 to ↩ 5817) within the monitoring limits.

4.5.3.9 Mains Voltage Increase

General notes

Voltage is monitored depending on parameter "Monitoring" (parameter [↩ 8806](#)). This function allows the monitoring of the voltage quality over a longer time period. It is realized as a 10 minute moving average. The function is only active, if mains is within the operating range. If "Mains voltage measuring" (parameter [↩ 1853](#)) is configured to a three-phase measurement, the slow voltage increase alarm is monitoring the individual three-phase voltages of the mains according to parameter "AND characteristics" (parameter [↩ 8849](#)). The parameter "Mains decoupling volt. incr." (parameter [↩ 8808](#)) determines if a voltage increase shall trigger a mains decoupling or not.



If this protective function is triggered, the display indicates "Mains volt. increase". The alarm can be incorporated into the mains decoupling function.



The average is set to "Mains rated voltage" (parameter [↩ 1768](#)) if:

- Frequency is not in the operating range OR
- Monitoring (parameter [↩ 8806](#)) is "Off" OR
- Monitoring is "Delayed by engine speed" (parameter [↩ 8833](#)) OR
- Monitoring is tripped AND the measured voltage is again in the operating range

Back synchronization is only possible if:

- The 10 minute average value is smaller than the defined limit AND
- The actual measured value is inside the operating range AND
- The mains settling time is over

ID	Parameter	CL	Setting range [Default]	Description
8806	Monitoring	2	On	Voltage increase monitoring is carried out according to the following parameters.
			[Off]	No monitoring is carried out.
8807	Limit	1	100 to 150% [110%]	The percentage voltage value that is to be monitored is defined here. If the average voltage over 10 minutes is higher, the action specified by the alarm class is initiated.
				Notes This value refers to the "Mains rated voltage" (parameter ↩ 1768).
8849	AND characteristics	2	On	If the 10 minute voltage averages of all phases exceed the limit, the monitoring is tripping.
			[Off]	If the 10 minute voltage average of at least one phase exceeds the limit, the monitoring is tripping.
8831	Alarm class	2	Class A, Class B, Class C, Class D, Class E, Class F , Control [Class B]	Each limit may be assigned an independent alarm class that specifies what action should be taken when the limit is surpassed.
				Notes For additional information refer to ↩ "9.5.4 Alarm Classes"
8832	Self acknowledge	4	[Yes]	The control unit automatically clears the alarm if the fault condition is no longer detected.
			No	The control unit does not automatically reset the alarm when the fault condition is no longer detected.

ID	Parameter	CL	Setting range [Default]	Description
				The alarm must be acknowledged and reset by manually pressing the appropriate buttons or by activating the LogicsManager output "External acknowledgment" (via a discrete input or via an interface).
8833	Enabled	4	[Always]	Monitoring for this fault condition is continuously enabled.
			87.70 LM:Eng.mon	Monitoring for fault conditions is not performed until engine monitoring is enabled. This is determined through the LogicsManager equation "Release engine monitoring".
			For xx = 1 to 32: 96.{xx} LM: Flag{xx}	The monitoring is executed, if the LogicsManager "Flag {xx}" is TRUE. Example: 96.01 LM: Flag 1, 96.02 LM: Flag 2, ..., 96.32 LM: Flag 32
8808	Mains decoupling volt.incr.	2	On	Voltage increase monitoring does cause a decoupling.
			[Off]	Voltage increase monitoring does not cause a decoupling.
8850	Volt.incr.average	0	—	This visualization value shows the current 10 minute average voltage. Notes If 8849 is configured to AND, this value is the minimum value otherwise the maximum value of the averages. If "Mains voltage monitoring" (parameter ↔ 1771) is configured to ALL, this value is derived from the "Phase - Phase" values.

4.5.3.10 Mains Time-Dependent Voltage

General notes



Two Time Dependent Mains Voltage Monitors Available

Both monitors behave similar but each with a separate Fault-Ride-Through (FRT) curve.



Example of a Time Dependent Mains Voltage Curve

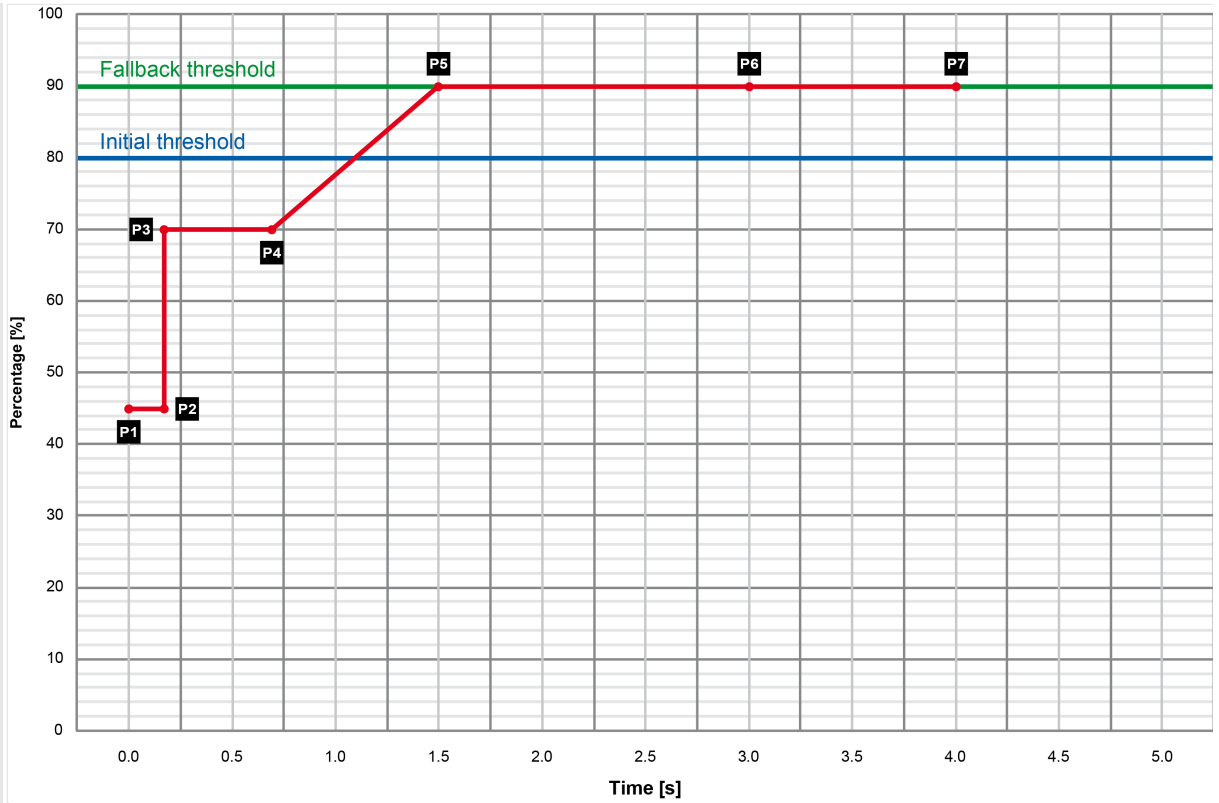

Fig. 224: Time-dependent voltage monitoring curve

P1	0.00 s → 45.0%
P2	0.15 s → 45.0%
P3	0.15 s → 70.0%
P4	0.70 s → 70.0%
P5	1.50 s → 90.0%
P6	3.00 s → 90.0%
P7	4.00 s → 90.0%
Fallback threshold	90.0%
Initial threshold	80.0%
Fallback time	1.00 s

General settings for Mains decoupling and Monitoring Voltage 1 - 3



Find parameters ...

Find parameters in two menus:

- [Configuration / Configure monitoring / Mains decoupling / General mains decoupling]
- [Configuration / Configure monitoring / Mains / Frequency / Voltage / Mains time-dependent voltage]

ID	Parameter	CL	Setting range [Default]	Description
4989	Mns.decoupl.by time-dep.volt.	2	[Default]	Mains decoupling by FRT monitoring.
			On	Time-dependent voltage monitoring does cause a decoupling.
			[Off]	Time-dependent voltage monitoring does not cause a decoupling.
4951	Alarm class	2	Class A, Class B, Class C, Class D, Class E, Class F , Control [Class B]	Each limit may be assigned an independent alarm class that specifies what action should be taken when the limit is surpassed.
				Notes For additional information refer to ↳ "9.5.4 Alarm Classes"
4959	Self acknowledge	2	[Yes]	The control unit automatically clears the alarm if the fault condition is no longer detected.
			No	The control unit does not automatically reset the alarm when the fault condition is no longer detected. The alarm must be acknowledged and reset by manually pressing the appropriate buttons or by activating the LogicsManager output "External acknowledgment" (via a discrete input or via an interface).

Table 78: Time Dependent Voltage Monitoring settings

4.5.3.10.1 Time Dependent Mains Voltage Monitor 1

This monitoring function is supporting a dynamic stabilization of mains. To maintain the VDE-AR-N 4105 and VDE-AR-N 4110 grid code (2019) up to 3 FRT (Fault-Ride-Through) curves can be defined.

The voltage is monitored depending on parameter "Mains voltage measuring" (parameter [↳ 1853](#)).



Furthermore it can be configured either as undervoltage or overvoltage monitoring («underrun» or «overrun» selected with parameter "Monitoring at [↳ 4953](#)). If the measured voltage of at least N phase (N is defined with parameter 4960) falls below/exceeds the configured "Initial threshold" (parameter [↳ 4970](#)), the time-dependent voltage monitoring sequence starts and the voltage threshold will change in time according to the configured threshold curve points (see [↳ Fig. 224](#)).

If the measured voltage falls below/exceeds this curve, the monitoring function triggers and LogicsManager command variable "07.28 Time-dep. voltage 1" becomes TRUE. The mains decoupling function is incorporated, if configured. If the measured voltage falls below/exceeds the configured "Fallback threshold" (parameter [↳ 4978](#)) for at least the configured "Fallback time" (parameter [↳ 4968](#)), the time-dependent voltage monitoring sequence will be reset.

The threshold curve results from seven configurable points and a linear interpolation between these points.  Fig. 224 shows an example of a Low-Voltage-Ride-Through (LVRT) curve for time-dependent voltage monitoring. The curve is configured by default according to a typical grid code requirement.



Rules for configuration

The time points should always have an ascending order. The fallback threshold (parameter  4978) should always be configured to a value higher/lower than the initial threshold (parameter  4970).

The monitoring on undervoltage over the undervoltage curve (or overvoltage or overvoltage curve) is always active, if the »Monitoring« (parameter  4950) is enabled. A mains decoupling is only executed, if the generator runs parallel to mains.

The monitor behaves according to the configured »AND characteristic« (parameter 4960). When the AND characteristic is configured to "On", all 3 phases are taken into account. Only if **all** phases are below/above the configurable curve, the monitor will trip. When the AND characteristic is configured to "Off", the single phases are taken into account. Even if only one phase runs below/above the configurable curve, the monitor will trip.

The monitoring starts with passing the initial threshold. The tripping time is determined by the voltage deviation and its according curve location. The monitoring is disabled, if the voltage value (values) have crossed the fallback threshold. The monitor trips the LogicsManager command variable 10877 "07.28 Time-dep. voltage 1".

FRT Monitoring Characteristic

The monitoring type influences the FRT:

Parameter "Mains voltage monitoring"  1771 determines, if the Ph-Ph, Ph-N, or all measurements are used.

If type "All" is available and configured, and **3Ph4W** is configured, "Time dependent Voltage Monitoring" is calculated with phase-phase and phase-neutral voltages. If **All and 1Ph3W** is configured, only PH-N values are used.

The mains time-dependent monitoring works with configurable FRT characteristics. In conjunction with mains voltage measuring (ID1853) and mains voltage monitoring (see section before) different monitoring procedures take place.

Blocking ROCOF Monitor During Dynamic Mains Stabilization

Due the higher prioritization of the Dynamic Mains Stabilization (FRT) as the ROCOF monitor, the ROCOF monitor must be disabled for longest 5 seconds when any FRT curve was initiated. Therefore each FRT (=Time-dependent voltage monitoring) function provides a flag. The flag is set, if the particular initiation threshold is passed. The flag is reset if all monitored voltages are back in band (parameter  4978).

The 3 flags are OR'ed and results in one "FRT initiated" flag. This flag will be kept TRUE for maximal 5 seconds. Finally this ROCOF blocking flag will be inverted and entered as LM Command Variable "07.34 FRT ROCOF enable".

Time-dep. voltage 1

ID	Parameter	CL	Setting range [Default]	Description
4950	Monitoring	2	On	Time-dependent voltage monitoring is carried out according to the following parameters.
			[Off]	No monitoring is carried out.
4960	Characteristic	2		The mains time-dependent monitoring works with different characteristics.
			[1-phase]	Uses the lowest/highest phase for triggering the alarm. If "1771 Mains voltage monitoring" is configured to "All", the alarm will be triggered if at least one phase L-L or at least one phases L-N is out of range and will be reset if all phases of L-L and all phases of L-N are in range.
			2-phase	Uses the two lowest/highest phases for triggering the alarm. If "1771 Mains voltage monitoring" is configured to "All", the alarm will be triggered if at least two phases L-L or at least two phases L-N are out of range and will be reset if at least two phases of L-L and at least two phases of L-N are in range.
			3-phase	Uses all three phases (symmetric condition) for triggering the alarm. If "1771 Mains voltage monitoring" is configured to "All", the alarm will be triggered if all phases L-L or all phases L-N are out of range and will be reset if at least one phase of L-L and at least one phase of L-N is in range.
4953	Monitoring at	2		Selects whether the system shall do over- or undervoltage monitoring.
			[Underrun]	The undervoltage monitoring is carried out (The monitoring function triggers if the measured voltage is below the curve).
			Overrun	The overvoltage monitoring is carried out (The monitoring function triggers if the measured voltage exceeds the curve).
4970	Init threshold	2	0.0 to 150.0% [80.0%]	The time-dependent voltage monitoring initial threshold is configured here. If the measured voltage falls below/exceeds this threshold, the monitoring sequence starts and the voltage threshold will change in time according to the configured threshold curve points. If the measured voltage falls below/exceeds this curve, the

4 Configuration

4.5.3.10.1 Time Dependent Mains Voltage Monitor 1

ID	Parameter	CL	Setting range [Default]	Description
				monitoring function triggers and the configured relay will energize.
4978	Fallback threshold	2	0.0 to 150.0% [90.0%]	<p>The time-dependent voltage monitoring fallback voltage is configured here. If the measured voltage falls below/exceeds the voltage configured here for at least the configured "Fallback time", the monitoring sequence will be reset.</p> <p>Notes</p> <p>This parameter should always be configured to a value higher/lower than the "Init threshold" (parameter ↩ 4970) for proper operation.</p> <p>The parameter "Point 7 voltage" (parameter ↩ 4977) is used as fallback threshold if it is configured to a value higher/lower than the parameter "Fallback threshold" (parameter ↩ 4978).</p>
4968	Fallback time	2	0.00 to 320.00 s [1.00 s]	The time-dependent voltage monitoring fallback time is configured here. If the measured voltage falls below/exceeds the configured "Fallback threshold" (parameter ↩ 4978) for at least the time configured here, the monitoring sequence will be reset.
4971	Point 1 voltage [x = 1 to 7]	2	0.0 to 150.0%	The voltage values of time-dependent voltage monitoring voltage points are configured here.
4972			4971: [45.0%]	
4973			4972: [45.0%]	
4974			4973: [70.0%]	
4975			4974: [70.0%]	
4976			4975: [90.0%]	
4977			4976: [90.0%] 4977: [90.0%]	
				Notes Please avoid a setting between 0.1% and 5.0%.
4961	Point 1 time [x = 1 to 7]	2	0.00 to 320.00 s	The time values of time-dependent voltage monitoring time points are configured here.
4962			4961: [0.00 s]	
4963			4962: [0.15 s]	
4964			4963: [0.15 s]	
4965			4964: [0.70 s]	
4966			4965: [1.50 s] 4966: [3.00 s]	

ID	Parameter	CL	Setting range [Default]	Description
4967			4967: [4.00 s]	

4.5.3.10.2 Time Dependent Mains Voltage Monitor 2

The Time dependent voltage monitoring 2 is an additional independent FRT monitoring, which behaves like the Time dependent voltage monitoring 1 described in the previous chapter.

It serves a LogicsManager command variable 11750 "07.31 Time-dep. voltage 2" to trip a relay or to incorporate the monitoring into the mains decoupling feature of the device.

The alarm class and the self-acknowledge feature is taken from the original time dependent voltage monitoring (see [↳ "General settings for Mains decoupling and Monitoring Voltage 1 - 3"](#)).

Time-dep. voltage 2

ID	Parameter	CL	Setting range [Default]	Description
4954	Monitoring	2	On	Time-dependent voltage 2 monitoring is carried out according to the following parameters.
			[Off]	No monitoring is carried out.
				Notes. It is an additional independent FRT monitoring. It serves a LogicsManager command variable to trip a relay or to incorporate the monitoring into the mains decoupling function of the device. The alarm class and the self-acknowledge setting is shared with the other time dependent voltage monitoring. (Id 4951 and Id 4959)
4957	Monitoring at	2		Selects whether the system shall do over- or undervoltage monitoring.
			[Underrun]	The undervoltage monitoring is carried out (The monitoring function triggers if the measured voltage is below the curve).
			Overrun	The overvoltage monitoring is carried out (The monitoring function triggers if the measured voltage exceeds the curve).
4969	Characteristic	2		The mains time-dependent monitoring works with different characteristics.
			[1-phase]	Uses the lowest/highest phase for triggering the alarm. If "1771 Mains voltage monitoring" is configured to "All", the alarm will be triggered if at least one phase L-L or at least one phases L-N is

4 Configuration

4.5.3.10.2 Time Dependent Mains Voltage Monitor 2

ID	Parameter	CL	Setting range [Default]	Description
				out of range and will be reset if all phases of L-L and all phases of L-N are in range.
			2-phase	Uses the two lowest/highest phases for triggering the alarm. If "1771 Mains voltage monitoring" is configured to "All", the alarm will be triggered if at least two phases L-L or at least two phases L-N are out of range and will be reset if at least two phases of L-L and at least two phases of L-N are in range.
			3-phase	Uses all three phases (symmetric condition) for triggering the alarm. If "1771 Mains voltage monitoring" is configured to "All", the alarm will be triggered if all phases L-L or all phases L-N are out of range and will be reset if at least one phase of L-L and at least one phase of L-N is in range.
4990	Init threshold	2	0.0 to 200.0% [80.0%]	<p>The time-dependent voltage 2 monitoring initial threshold is configured here. If the measured voltage falls below/exceeds this threshold, the monitoring sequence starts and the voltage threshold will change in time according to the configured threshold curve points.</p> <p>If the measured voltage 2 falls below/exceeds this curve, the monitoring function triggers and the configured relay will energize.</p>
4998	Fallback threshold	2	0.0 to 200.0% [90.0%]	<p>The time-dependent voltage 2 monitoring fallback voltage is configured here. If the measured voltage falls below/exceeds the voltage configured here for at least the configured "Fallback time" (parameter ↩ 4988), the monitoring sequence will be reset.</p> <p>Notes</p> <p>This parameter should always be configured to a value higher/lower than the "Init threshold" (parameter ↩ 4990) for proper operation.</p> <p>The parameter "Point 7 voltage" (parameter ↩ 4997) is used as fallback threshold if it is configured to a value higher/lower than the parameter "Fallback threshold" (parameter ↩ 4998).</p>
4988	Fallback time	2	0.00 to 320.00 s [1.00 s]	The time-dependent voltage 2 monitoring fallback time is configured here. If the measured voltage falls below/exceeds the configured "Fallback threshold" (parameter ↩ 4998) for at least

ID	Parameter	CL	Setting range [Default]	Description
				the time configured here, the monitoring sequence will be reset.
4991	Point 1 voltage [x = 1 to 7]	2	0.0 to 200.0%	The voltage values of time-dependent voltage 2 monitoring voltage points are configured here.
4992			4991: [10.0%]	
4993			4992: [10.0%]	
4994			4993: [90.0%]	
4995			4994: [90.0%]	
4996			4995: [90.0%]	
4997			4996: [90.0%] 4997: [90.0%]	
				Notes Please avoid a setting between 0.1% and 5.0%.
4981	Point 1 time [x = 1 to 7]	2	0.00 to 320.00 s	The time values of time-dependent voltage 2 monitoring time points are configured here.
4982			4981: [0.00 s]	
4983			4982: [0.15 s]	
4984			4983: [1.50 s]	
4985			4984: [10.00 s]	
4986			4985: [20.00 s]	
4987			4986: [30.00 s] 4987: [40.00 s]	

4.5.3.10.3 Time Dependent Mains Voltage Monitor 3

The Time dependent voltage monitoring 3 is an additional independent FRT monitoring, which behaves like the Time dependent voltage monitoring 1 described in the previous chapter.

It serves a LogicsManager command variable 11750 "07.33 Time-dep. voltage 3" to trip a relay or to incorporate the monitoring into the mains decoupling feature of the device.

The alarm class and the self-acknowledge feature is taken from the original time dependent voltage monitoring (see [↳ "General settings for Mains decoupling and Monitoring Voltage 1 - 3"](#)).

Time-dep. voltage 3

ID	Parameter	CL	Setting range [Default]	Description
9130	Monitoring	2	On	Enabling the time-dependent voltage monitoring 3. It is an additional independent FRT monitoring. It serves a

4 Configuration

4.5.3.10.3 Time Dependent Mains Voltage Monitor 3

ID	Parameter	CL	Setting range [Default]	Description
				LogicsManager command variable to trip a relay or to incorporate the monitoring into the mains decoupling function of the device. The alarm class and the self-acknowledge setting is shared with the other time dependent voltage monitoring. (Id 4951 and Id 4959)
			[Off]	No monitoring is carried out.
				Notes. It is an additional independent FRT monitoring. It serves a LogicsManager command variable to trip a relay or to incorporate the monitoring into the mains decoupling function of the device. The alarm class and the self-acknowledge setting is shared with the other time dependent voltage monitoring. (Id 4951 and Id 4959)
4979	Characteristic	2		The mains time-dependent monitoring works with different characteristics.
			[1-phase]	Uses the lowest/highest phase for triggering the alarm. If "1771 Mains voltage monitoring" is configured to "All", the alarm will be triggered if at least one phase L-L or at least one phases L-N is out of range and will be reset if all phases of L-L and all phases of L-N are in range.
			2-phase	Uses the two lowest/highest phases for triggering the alarm. If "1771 Mains voltage monitoring" is configured to "All", the alarm will be triggered if at least two phases L-L or at least two phases L-N are out of range and will be reset if at least two phases of L-L and at least two phases of L-N are in range.
			3-phase	Uses all three phases (symmetric condition) for triggering the alarm. If "1771 Mains voltage monitoring" is configured to "All", the alarm will be triggered if all phases L-L or all phases L-N are out of range and will be reset if at least one phase of L-L and at least one phase of L-N is in range.
9133	Monitoring at	2		Selects whether the system shall do over- or undervoltage monitoring.
			Underrun	The undervoltage monitoring is carried out (The monitoring function triggers if the measured voltage is below the curve).
			[Overrun]	The overvoltage monitoring is carried out (The monitoring

ID	Parameter	CL	Setting range [Default]	Description
				function triggers if the measured voltage exceeds the curve).
9148	Init threshold	2	0.0 to 200.0% [115.0%]	The time-dependent voltage monitoring initial threshold is configured here. If the measured voltage falls below/exceeds this threshold, the monitoring sequence starts and the voltage threshold will change in time according to the configured threshold curve points. If the measured voltage falls below/exceeds this curve, the monitoring function triggers and the configured alarm / decoupling will be initiated.
	Fallback threshold	2	0.0 to 200.0% [110.0%]	The time-dependent voltage monitoring fallback voltage is configured here. If the measured voltage falls below/exceeds the voltage configured here for at least the configured "Fallback time" (parameter ↩ 9147), the monitoring sequence will be reset.
				<p>Notes</p> <p>This parameter should always be configured to a value higher/lower than the "Init threshold" (parameter ↩ 9148) for proper operation.</p> <p>The parameter "Point 7 voltage" (parameter ↩ 9155) is used as fallback threshold if it is configured to a value higher/lower than the parameter "Fallback threshold" (parameter ↩).</p>
9147	Fallback time	2	0.00 to 320.00 s [1.00 s]	The time-dependent voltage monitoring fallback time is configured here. If the measured voltage falls below/exceeds the configured "Fallback threshold" (parameter ↩) for at least the time configured here, the monitoring sequence will be reset.
9149	Point 1 voltage	2	0.0 to 150.0%	The voltage values of time-dependent voltage monitoring voltage points are configured here.
9150	[x = 1 to 7]		9149: [125.0%]	
9151			9150: [125.0%]	
9152			9151: [120.0%]	
9153			9152: [120.0%]	
9154			9153: [115.0%]	
9155			9154: [115.0%] 9155: [110.0%]	
				Notes

4 Configuration

4.5.3.10.4 Time dependent voltage monitoring - Decoupling Function

ID	Parameter	CL	Setting range [Default]	Description
				Avoid a setting between 0.1% and 5.0%.
9140	Point 1 time	2	0.00 to 320.00 s	The time values of time-dependent voltage monitoring time points are configured here.
9141	[x = 1 to 7]		9140: [0.00 s]	
9142			9141: [0.10 s]	
9143			9142: [1.10 s]	
9144			9143: [5.00 s]	
9145			9144: [5.00 s]	
9146			9145: [60.00 s] 9146: [60.00 s]	

4.5.3.10.4 Time dependent voltage monitoring - Decoupling Function

The 3 Time dependent voltage monitorings can be allocated to the mains decoupling function. With a configuration general all 3 FRT monitors are included.

ID	Parameter	CL	Setting range [Default]	Description
4989	Mns.decoupl.by time-dep.volt.	2		Mains decoupling by FRT monitoring.
			On	Time-dependent voltage monitoring does cause a decoupling.
			[Off]	Time-dependent voltage monitoring does not cause a decoupling.

Table 79: Time Dependent Voltage Monitoring 1

Alarm flags (latched)

Time dependent voltage 1 (FRT1) is LM flag 07.28, ID10877

Time dependent voltage 2 (FRT2) is LM flag 07.31, ID11750

Time dependent voltage 3 (FRT3) is LM flag 07.33, ID11751

4.5.3.11 QV Monitoring

General notes

In case of mains undervoltage some grid codes require a special monitoring function to avoid the import of inductive reactive power at the mains interchange point. The monitoring function measures close to the generator. For this reason the QV monitoring is a function of generator voltage and generator reactive power.

QV monitoring is triggered if the following conditions are fulfilled: (Refer to [Fig. 225](#) for details)

- QV monitoring is configured to "On" (parameter [3292](#))
- Measured reactive power is higher than the configured "Reactive power threshold" (parameter [3291](#))
- Measured voltages are below the configured "Limit undervoltage" (parameter [3285](#))

As a result Timer 1 and Timer 2 are starting. If the delay time "Delay step 1" (parameter [3283](#)) has exceeded, the LogicsManager command variable "07.29 QV monitoring 1" becomes TRUE and the corresponding alarm message "QV monitoring 1" is indicated. If the delay time "Delay step 2" (parameter [3284](#)) has exceeded, the LogicsManager command variable "07.30 QV monitoring 2" becomes TRUE and the corresponding alarm message "QV monitoring 2" is indicated.

If parameter "Mains decoupling by QV" (parameter [3296](#)) is configured to "On" the decoupling function is assigned to "Delay step 1" (parameter [3283](#)).



- The LogicsManager command flags 07.29 and 07.30 can be additionally used to cause other actions according to the corresponding regulations of the grid.
- The QV Monitoring function according the German grid code VDE-AR-N 4105 depends on the parameter [1770](#) "phase-phase/phase-neutral monitoring".

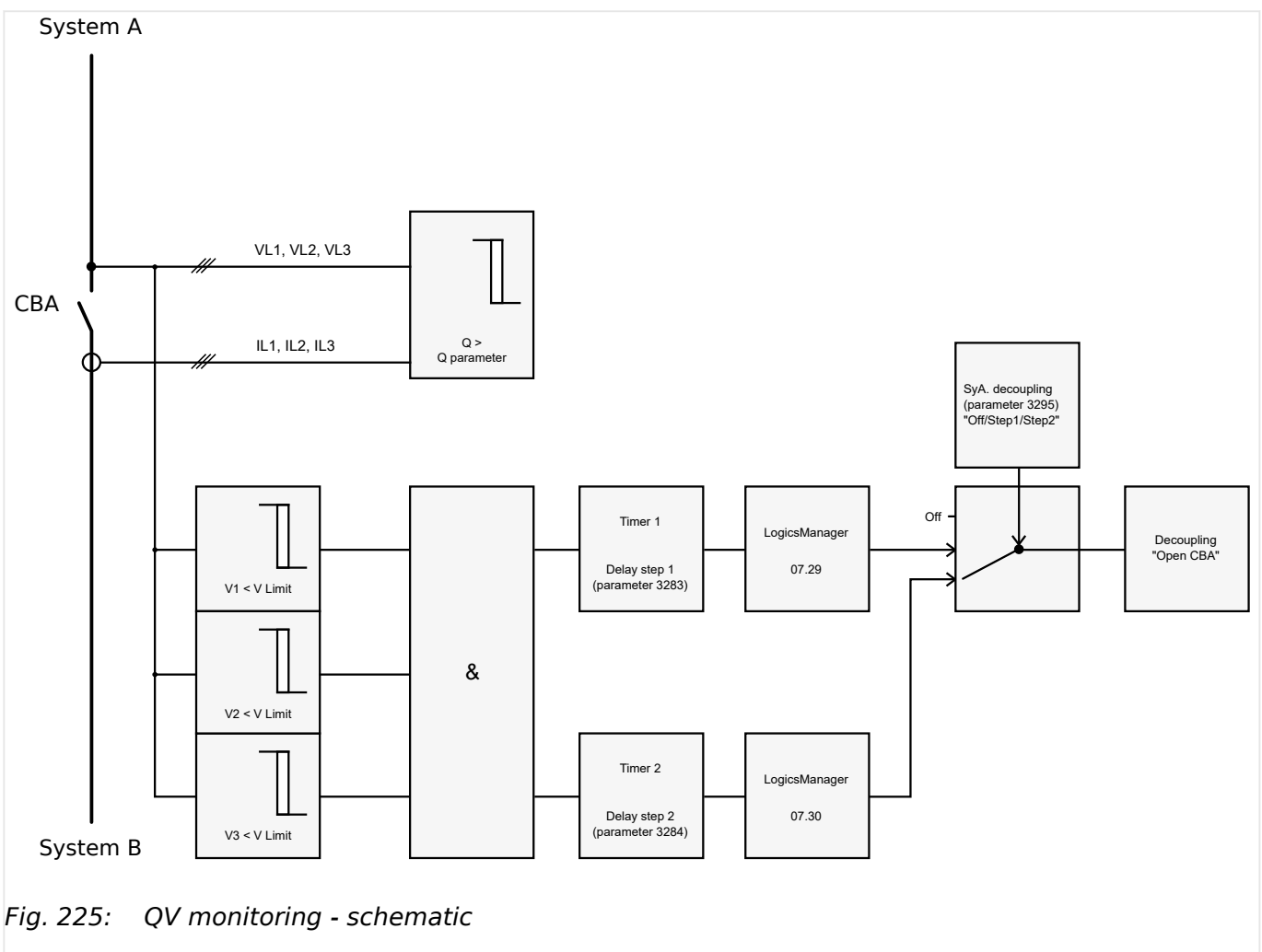

Fig. 225: QV monitoring - schematic

ID	Parameter	CL	Setting range [Default]	Description
3292	Monitoring	2	On	QV monitoring is carried out according to the following parameters.
			[Off]	No monitoring is carried out.
3285	Limit undervoltage	2	45 to 150% [85%]	The percentage voltage value that is to be monitored is defined here. If the voltages of all phases (one phase in 1Ph 2W system) are below this limit, the voltage condition for tripping the monitoring function is TRUE.
				Notes This value refers to the "Generator rated voltage" (parameter ↩ 1766).
3291	Reactive power threshold	2	2 to 100% [5%]	The percentage reactive value that is to be monitored is defined here. If the absolute value of reactive power Q is higher than this threshold, the reactive power condition for tripping the monitoring function is TRUE.
				Notes This value refers to the "Gen. rated react. power [kvar]" (parameter ↩ 1758).
3283	Delay step 1	2	0.10 to 99.99 s [0.50 s]	If the QV monitoring conditions are met, for the delay time configured here, an alarm "QV monitoring 1" will be issued and the LogicsManager command variable "07.29 QV monitoring 1" becomes TRUE.
				Notes The decoupling function is only activated if "Mains decoupling by QV" (parameter ↩ 3296) is configured to "On".
3284	Delay step 2	2	0.10 to 99.99 s [1.50 s]	If the QV monitoring conditions are met, for the delay time configured here, an alarm "QV monitoring 2" will be issued and the LogicsManager command variable "07.29 QV monitoring 1" becomes TRUE.
3280	Alarm class	2	Class A, Class B, Class C, Class D, Class E, Class F , Control [Class B]	The alarm class specifies what action should be taken when at least one delay has been exceeded.
				Notes

ID	Parameter	CL	Setting range [Default]	Description
				The alarm class is valid for parameter ↩ 3283 and ↩ 3284 . For additional information refer to ↩ "9.5.4 Alarm Classes"
3293	Self acknowledge	2	[Yes]	The control unit automatically clears the alarm if the fault condition is no longer detected.
			No	The control unit does not automatically reset the alarm when the fault condition is no longer detected. The alarm must be acknowledged and reset by manually pressing the appropriate buttons or by activating the LogicsManager output "External acknowledgment" (via a discrete input or via an interface).
				Notes The self acknowledge is valid for parameter ↩ 3283 and ↩ 3284 .
3296	Mains decoupling by QV	2	On	The QV monitoring function is linked to the mains decoupling function with all its consequences and is assigned to "Delay step 1" (parameter ↩ 3283).
			[Off]	The QV monitoring function is ignored in the mains decoupling function.

4.5.3.12 Change Of Frequency

Phase shift

A vector/phase shift is defined as the sudden variation of the voltage curve which may be caused by a major generator load change. It usually occurs, if the utility opens the MCB, which causes a load change for the genset.

The genset control measures the duration of a cycle, where a new measurement is started with each voltage passing through zero. The measured cycle duration will be compared with an internal quartz-calibrated reference time to determine the cycle duration difference of the voltage signal.



The phase shift monitoring is a very sensitive functionality and reacts according to the settings on each sinus wave constellation.

Please be aware that under special circumstances it may come to a phase shift trip, when switching elements are taken into the mains measurement lines because mains voltage sensing lines are switched nearby the genset control.

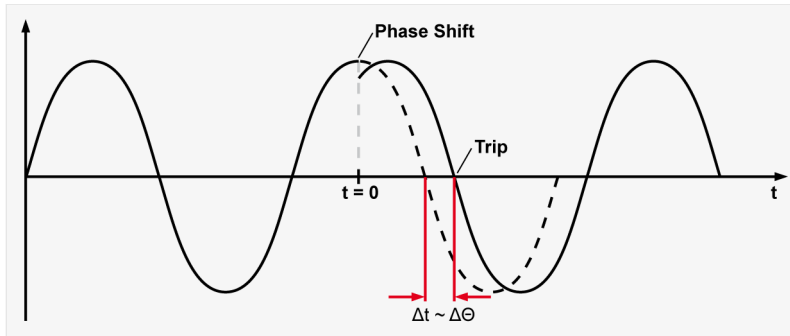

Fig. 226: Phase shift

A vector/phase shift as shown in [Fig. 226](#) causes a premature or delayed zero passage. The determined cycle duration difference corresponds with the occurring phase shift angle.

The monitoring may be carried out three-phased or one/three-phased. Different limits may be configured for one-phase and three-phase monitoring. The vector/phase shift monitor can also be used as an additional method to decouple from the mains. Vector/phase shift monitoring is only enabled after the monitored voltage exceeds 50% of the PT secondary rated voltage.



Function "Voltage cycle duration not within the permissible range"

The voltage cycle duration exceeds the configured limit value for the phase/vector shift. The result is, that the power circuit breaker that disconnects from the mains, is opened, the message "Mains phase shift" is displayed, and the logical command variable "07.14" is enabled.

The prerequisite for phase/vector shift monitoring is that the generator is operating in a mains parallel operation (the MCB and GCB are both closed).

df/dt (ROCOF)

df/dt (rate of change of frequency) monitoring measures the stability of the frequency. The frequency of a source will vary due to changing loads and other effects. The rate of these frequency changes due to the load variances is relatively high compared to those of a large network.



Function "Rate of change of frequency not within permissible limits"

The control unit calculates the unit of measure per unit of time. The df/dt is measured over 4 sine waves to ensure that it is differentiated from a phase shift. This results in a minimum response time of approximately 100 ms (at 50 Hz).

ID	Parameter	CL	Setting range [Default]	Description
3058	Change of frequency	2	Off	Monitoring is disabled.
			[Phase shift]	Phase shift monitoring is carried out according to the parameters described in "Phase shift" .

ID	Parameter	CL	Setting range [Default]	Description
			df/dtdf/dt	df/dt monitoring is carried out according to the parameters described in ↩> "df/dt (ROCOF)" .
			Ph-shift,df/dt	Phase shift monitoring and df/dt monitoring is carried out. Tripping occurs if phase shift or df/dt is triggered.
3053	Monitoring	2	[1- and 3-phase]	During single-phase voltage phase/vector shift monitoring, tripping occurs if the phase/vector shift exceeds the configured threshold value (parameter ↩> 3054) in at least one of the three phases.
			3-phase	During three-phase voltage phase/vector shift monitoring, tripping occurs only if the phase/vector shift exceeds the specified threshold value (parameter ↩> 3055) in all three phases within 2 cycles.
				<p>Notes</p> <p>If a phase/vector shift occurs in one or two phases, the single-phase threshold value (parameter ↩> 3054) is taken into consideration; if a phase/vector shift occurs in all three phases, the three-phase threshold value (parameter ↩> 3055) is taken into consideration. Single phase monitoring is very sensitive and may lead to nuisance tripping if the selected phase angle settings are too small.</p> <p>3 phase mains phase shift monitoring is only enabled if Mains voltage measuring (parameter ↩> 1853) is configured to "3Ph 4W" or "3Ph 3W".</p>
3054	Limit 1-phase	2	3 to 30° [20°]	<p>If the electrical angle of the mains voltage shifts more than this configured value in any single phase, an alarm with the class configured in parameter ↩> 3051 is initiated.</p> <p>Depending on the configured mains decoupling procedure (parameter ↩> 3110), the GCB, MCB, or an external CB will be opened.</p>
3055	Limit 3-phase	2	3 to 30° [8°]	<p>If the electrical angle of the mains voltage shifts more than this configured value in all three phases, an alarm with the class configured in parameter ↩> 3051 is initiated.</p> <p>Depending on the configured mains decoupling procedure</p>

4 Configuration

4.5.3.12 Change Of Frequency

ID	Parameter	CL	Setting range [Default]	Description
				(parameter ↩ 3110), the GCB, MCB, or an external CB will be opened.
3051	Alarm class	2	Class A, Class B, Class C, Class D, Class E, Class F , Control [Class B]	Each limit may be assigned an independent alarm class that specifies what action should be taken when the limit is surpassed. Notes For additional information refer to ↩ "9.5.4 Alarm Classes" .
3052	Self acknowledge	2	[Yes]	The control automatically clears the alarm if the fault condition is no longer detected.
			No	The control does not automatically reset the alarm when the fault condition is no longer detected. The alarm must be acknowledged and reset by manually pressing the appropriate buttons or by activating the LogicsManager output "External acknowledgment" (via a discrete input or via an interface).
3056	Enabled	4	[Always]	Monitoring for this fault condition is continuously enabled.
			87.70 LM:Eng.mon	Monitoring for fault conditions is not performed until engine monitoring is enabled. This is determined through the LogicsManager equation "Release engine monitoring".
			For xx = 1 to 32: 96.{xx} LM: Flag{xx}	Defining of an own release flag through Logicsmanager equations.
			FRT ROCOF enable	The dynamic mains stabilization according to VDE-AR-N 4110/4105 requires a temporary blocking of the ROCOF monitor. Please refer to the according VDE-AR-N rule.
3104	Limit	2	0.1 to 9.9 Hz/s [2.6 Hz/s] (Hysteresis: 0.1 Hz/s) (Reset Delay: 80 ms)	The df/dt threshold is defined here. If this value is reached or exceeded for at least the delay time without interruption, an alarm with the class configured in parameter ↩ 3101 is initiated. Depending on the configured mains decoupling procedure (parameter ↩ 3110), the GCB, MCB, or an external CB will be opened.
3105	Delay	2	0.10 to 2.00 s [0.10 s]	If the monitored rate of df/dt exceeds the threshold value for the delay time configured here, an alarm will be issued.

ID	Parameter	CL	Setting range [Default]	Description
				If the monitored df/dt exceeds the threshold (plus the hysteresis) again before the delay expires the time will be reset.
3101	Alarm class	2	Class A, Class B, Class C, Class D, Class E, Class F , Control [Class B]	Each limit may be assigned an independent alarm class that specifies what action should be taken when the limit is surpassed. Notes For additional information refer to "9.5.4 Alarm Classes" .
3102	Self acknowledge	2	Yes [No]	The control automatically clears the alarm if the fault condition is no longer detected. The control does not automatically reset the alarm when the fault condition is no longer detected. The alarm must be acknowledged and reset by manually pressing the appropriate buttons or by activating the LogicsManager output "External acknowledgment" (via a discrete input or via an interface).
3103	Enabled	4	[Always] 87.70 LM:Eng.mon <i>For xx = 1 to 32:</i> 96.{xx} LM: Flag{xx} FRT ROCOF enable	Monitoring for this fault condition is continuously enabled. Monitoring for fault conditions is not performed until engine monitoring is enabled. This is determined through the LogicsManager equation "Release engine monitoring". Defining of an own release flag through Logicsmanager equations. The dynamic mains stabilization according to VDE-AR-N 4110/4105 requires a temporary blocking of the ROCOF monitor. Please refer to the according VDE-AR-N rule.

4.5.3.13 Mains Voltage Phase Rotation

General notes

NOTICE!



Damage to the control unit and/or generation equipment

- Please ensure during installation that all voltages applied to this unit are wired correctly to both sides of the circuit breaker.

Failure to do so may result in damage to the control unit and/or generation equipment due to closing the breaker asynchronous or with mismatched phase rotations and phase rotation monitoring enabled at all connected components (engine, generator, breakers, cable, busbars, etc.).

This function will block a connection of systems with mismatched phases only under the following conditions:

- The voltages being measured are wired correctly with respect to the phase rotation at the measuring points (i.e. the voltage transformer in front and behind the circuit breaker)
- The measuring voltages are wired without angular phase shift or interruption from the measuring point to the control unit
- The measuring voltages are wired to the correct terminals of the control unit (i.e. L1 of the generator is connected with the terminal of the control unit which is intended for the L1 of the generator)
- The LogicsManager function "Enable MCB" (refer to parameter  12923) is false in case of a incorrect rotation field

Correct phase rotation of the phase voltages ensures that damage will not occur during a breaker closure to either the mains or the generator. The voltage phase rotation alarm checks the phase rotation of the voltages and the configured phase rotation to ensure they are identical.





The directions of rotation are differentiated as "clockwise" and "counter clockwise". With a clockwise field the direction of rotation is "L1-L2-L3"; with a counter clockwise field the direction of rotation is "L1-L3-L2".

If the control is configured for a clockwise rotation and the voltages into the unit are calculated as counterclockwise the alarm will be initiated. The direction of configured rotation being monitored by the control unit is displayed on the screen.



If this protective function is triggered, the display indicates "Mns.ph.rot. mismatch" and the logical command variable "07.05" will be enabled.



This monitoring function is only enabled if Mains voltage measuring (parameter  1853) is configured to "3Ph 4W" or "3Ph 3W" and the measured voltage exceeds 50 % of the rated voltage (parameter  1768) or if Mains voltage measuring (parameter  1853) is configured to "1Ph 2W" (in this case, the phase rotation is not evaluated, but defined by the 1Ph2W phase rotation (parameter  1859)).

ID	Parameter	CL	Setting range [Default]	Description
3970	Monitoring	2	[On]	Phase rotation monitoring is carried out according to the following parameters.
			Off	No monitoring is carried out.
3974	Mains phase rotation	2	[CW]	The three-phase measured mains voltage is rotating CW (clock-wise; that means the voltage rotates in L1-L2-L3 direction; standard setting).
			CCW	The three-phase measured mains voltage is rotating CCW (counter clock-wise; that means the voltage rotates in L1-L3-L2 direction).
3971	Alarm class	2	Class A, Class B, Class C, Class D, Class E, Class F , Control [Class B]	Each limit may be assigned an independent alarm class that specifies what action should be taken when the limit is surpassed.
				<p>Notes</p> <p>CAUTION: If an alarm class that leads to an engine shutdown (alarm class C or higher) is configured into this parameter, a main phase rotation alarm may lead to a genset shutdown due to an alarm of class C or higher.</p> <p>For additional information refer to 9.5.4 Alarm Classes</p>
3972	Self acknowledge	2	Yes	The control unit automatically clears the alarm if the fault condition is no longer detected.
			[No]	<p>The control unit does not automatically reset the alarm when the fault condition is no longer detected.</p> <p>The alarm must be acknowledged and reset by manually pressing the appropriate buttons or by activating the LogicsManager output "External acknowledgment" (via a discrete input or via an interface).</p>
3973	Enabled	2	[Always]	Monitoring for this fault condition is continuously enabled.
			87.70 LM:Eng.mon	Monitoring for fault conditions is not performed until engine monitoring is enabled. This is determined through the LogicsManager equation "Release engine monitoring".
			<p>For xx = 1 to 32:</p> <p>96.{xx}</p> <p>LM: Flag{xx}</p>	<p>The monitoring is executed, if the LogicsManager "Flag {xx}" is TRUE.</p> <p>Example:</p>

ID	Parameter	CL	Setting range [Default]	Description
				96.01 LM: Flag 1, 96.02 LM: Flag 2, ..., 96.32 LM: Flag 32

4.5.3.14 Mains Import Power (Level 1 & 2)

General notes

It is possible to monitor two independently configurable mains import power limit values. This function makes it possible to initiate external load shedding.



If this protective function is triggered, the display indicates "Mains import power 1" or "Mains import power 2" and the logical command variable "07.21" or "07.22" will be enabled.

ID	Parameter	CL	Setting range [Default]	Description
3200 3206	Monitoring	2	On	Mains import power monitoring is carried out according to the following parameters. Monitoring is performed at two levels. Both values may be configured independent from each other (prerequisite: Level 1 limit < Level 2 limit).
			[Off]	Monitoring is disabled for Level 1 limit and/or Level 2 limit.
3215 3216	Monitoring at	2	[Overrun]	The monitored value must exceed the limit to be considered as out of limits.
			Underrun	The monitored value must fall below the limit to be considered as out of limits.
3204 3210	Limit	2	0.00 to +150.00% 3204: [80.00%] 3210: [100.00%]	If this threshold value has been exceeded or fallen below (depending on the setting of parameter ↔ 3215 or ↔ 3216) for at least the delay time (parameter ↔ 3205 or ↔ 3211), the action specified by the alarm class is initiated.
			Notes This value refers to the Mains rated active power (parameter ↔ 1748).	
3213 3214	Hysteresis	2	0.00 to 99.99% [0.01%] (Reset Delay: 80 ms)	The monitored mains power level must return within the limits configured in parameter ↔ 3204 or ↔ 3210 plus or minus (depending on the setting of parameter ↔ 3215 or ↔ 3216) the value configured here, to reset the alarm.

ID	Parameter	CL	Setting range [Default]	Description
3205 3211	Delay	2	0.02 to 99.99 s [1.00 s]	<p>If the monitored mains import power falls below or exceeds (depending on the setting of parameter ↩ 3215 or ↩ 3216) the threshold value for the delay time configured here, an alarm will be issued.</p> <p>Notes</p> <p>If the monitored mains import power exceeds or falls below the threshold (plus or minus the hysteresis configured in parameter ↩ 3213 or ↩ 3214) before the delay expires the time will be reset.</p>
3201 3207	Alarm class	2	Class A, Class B, Class C, Class D, Class E, Class F , Control 3201: [Class A] 3207: [Class B]	<p>Each limit may be assigned an independent alarm class that specifies what action should be taken when the limit is surpassed.</p> <p>Notes</p> <p>For additional information refer to ↩ "9.5.4 Alarm Classes"</p>
3202 3208	Self acknowledge	2	3202: [Yes] 3208: [No]	<p>The control unit automatically clears the alarm if the fault condition is no longer detected.</p> <p>The control unit does not automatically reset the alarm when the fault condition is no longer detected.</p> <p>The alarm must be acknowledged and reset by manually pressing the appropriate buttons or by activating the LogicsManager output "External acknowledgment" (via a discrete input or via an interface).</p>
3203 3209	Enabled	2	[Always] 87.70 LM:Eng.mon <i>For xx = 1 to 32:</i> 96.{xx} LM: Flag{xx}	<p>Monitoring for this fault condition is continuously enabled.</p> <p>Monitoring for fault conditions is not performed until engine monitoring is enabled. This is determined through the LogicsManager equation "Release engine monitoring".</p> <p>The monitoring is executed, if the LogicsManager "Flag {xx}" is TRUE.</p> <p>Example:</p> <p>96.01 LM: Flag 1, 96.02 LM: Flag 2, ..., 96.32 LM: Flag 32</p>

4.5.3.15 Mains Export Power (Level 1 & 2)

General notes

It is possible to monitor two independently configurable mains export power limit values. This function makes it possible to initiate external load shedding.



If this protective function is triggered, the display indicates "Mains export power 1" or "Mains export power 2" and the logical command variable "07.23" or "07.24" will be enabled.

ID	Parameter	CL	Setting range [Default]	Description
3225 3233	Monitoring	2	On [Off]	Mains export power monitoring is carried out according to the following parameters. Monitoring is performed at two levels. Both values may be configured independent from each other (prerequisite: Level 1 limit < Level 2 limit). Monitoring is disabled for Level 1 limit and/or Level 2 limit.
3232 3240	Monitoring at	2	[Overrun] Underrun	The monitored value must exceed the limit to be considered as out of limits. The monitored value must fall below the limit to be considered as out of limits.
3229 3237	Limit	2	0 to +150.00% 3229: [80.00%] 3237: [100.00%]	If this threshold value has been exceeded or fallen below (depending on the setting of parameter ↩ 3232 or ↩ 3240) for at least the delay time (parameter ↩ 3230 or ↩ 3238), the action specified by the alarm class is initiated. Notes This value refers to the Mains rated active power (parameter ↩ 1748).
3231 3239	Hysteresis	2	0 to 99.99% [0.01%] (Reset Delay: 80 ms)	The monitored mains power level must return within the limits configured in parameter ↩ 3229 or ↩ 3237 plus or minus (depending on the setting of parameter ↩ 3232 or ↩ 3240) the value configured here, to reset the alarm.
3230 3238	Delay	2	0.02 to 99.99 s [1.00 s]	If the monitored mains export power falls below or exceeds (depending on the setting of ns export power falls below or exceeds (depending on the setting of parameter ↩ 3232 or ↩ 3240) the threshold value for the delay time configured here, an alarm will be issued.

ID	Parameter	CL	Setting range [Default]	Description
				<p>Notes</p> <p>If the monitored mains import power exceeds or falls below the threshold (plus or minus the hysteresis configured in parameter 3231 or 3239) before the delay expires the time will be reset.</p>
3226 3234	Alarm class	2	Class A, Class B, Class C, Class D, Class E, Class F , Control 3226: [Class A] 3234: [Class B]	<p>Each limit may be assigned an independent alarm class that specifies what action should be taken when the limit is surpassed.</p> <p>Notes</p> <p>For additional information refer to 9.5.4 Alarm Classes</p>
3227 3235	Self acknowledge	2	3227: [Yes] 3235: [No]	<p>The control unit automatically clears the alarm if the fault condition is no longer detected.</p> <p>The control unit does not automatically reset the alarm when the fault condition is no longer detected.</p> <p>The alarm must be acknowledged and reset by manually pressing the appropriate buttons or by activating the LogicsManager output "External acknowledgment" (via a discrete input or via an interface).</p>
3228 3236	Enabled	2	[Always] 87.70 LM:Eng.mon For xx = 1 to 32: 96.{xx} LM: Flag{xx}	<p>Monitoring for this fault condition is continuously enabled.</p> <p>Monitoring for fault conditions is not performed until engine monitoring is enabled. This is determined through the LogicsManager equation "Release engine monitoring".</p> <p>The monitoring is executed, if the LogicsManager "Flag {xx}" is TRUE.</p> <p>Example:</p> <p>96.01 LM: Flag 1, 96.02 LM: Flag 2, ..., 96.32 LM: Flag 32</p>

4.5.3.16 Engine/Mains Active Power Mismatch

General notes

If enabled, this monitoring function becomes only active if generator power control is enabled and the active power setpoint is configured to "Import" or "Export" (refer to [4.4.4.5 Load Control](#)). If the measured import or export power deviates from the power

setpoint by a value exceeding the limit configured in parameter [↩️ 2935](#) for a time exceeding the delay configured in parameter [↩️ 2933](#), an alarm will be issued.



If this protective function is triggered, the display indicates "Mns act.pwr mismatch" and the logical command variable "07.16" will be enabled.

ID	Parameter	CL	Setting range [Default]	Description
2930	Monitoring	2	[On]	On Monitoring of the mains active power mismatch is carried out according to the following parameters.
			Off	Monitoring is disabled.
2935	Limit	2	1.0 to 99.9% [5.0%]	If the difference between the measured import or export power and the power setpoint exceeds this value for at least the delay time (parameter ↩️ 2933) without interruption, the action specified by the alarm class is initiated.
				Notes This value refers to the mains rated active power (parameter ↩️ 1748).
2933	Delay	2	3 to 9999 s [30 s]	If the monitored active power mismatch exceeds the threshold value configured in parameter ↩️ 2935 for the delay time configured here, an alarm will be issued.
				Notes If the monitored active power mismatch falls below the threshold (minus the hysteresis) before the delay expires the time will be reset.
2931	Alarm class	2	Class A, Class B, Class C, Class D, Class E, Class F , Control [Class B]	Each limit may be assigned an independent alarm class that specifies what action should be taken when the limit is surpassed.
				Notes For additional information refer to ↩️ "9.5.4 Alarm Classes"
2932	Self acknowledge	2	Yes	The control unit automatically clears the alarm if the fault condition is no longer detected.
			[No]	The control unit does not automatically reset the alarm when the fault condition is no longer detected. The alarm must be acknowledged and reset by manually pressing the appropriate buttons or by

ID	Parameter	CL	Setting range [Default]	Description
				activating the LogicsManager output "External acknowledgment" (via a discrete input or via an interface).
2936	Enabled	2	[Always]	Monitoring for this fault condition is continuously enabled.
			87.70 LM:Eng.mon	Monitoring for fault conditions is not performed until engine monitoring is enabled. This is determined through the LogicsManager equation "Release engine monitoring".
			For xx = 1 to 32: 96.{xx} LM: Flag{xx}	The monitoring is executed, if the LogicsManager "Flag {xx}" is TRUE. Example: 96.01 LM: Flag 1, 96.02 LM: Flag 2, ..., 96.32 LM: Flag 32

4.5.3.17 Mains Lagging Power Factor (Level 1 & 2)

General notes

The power factor is monitored for becoming more lagging (i.e. inductive) than an adjustable limit. This limit may be a lagging or leading power factor limit. There are two lagging power factor alarm levels available in the control. This monitoring function may be used for monitoring or controlling the power factor compensation. Both alarms are definite time alarms.

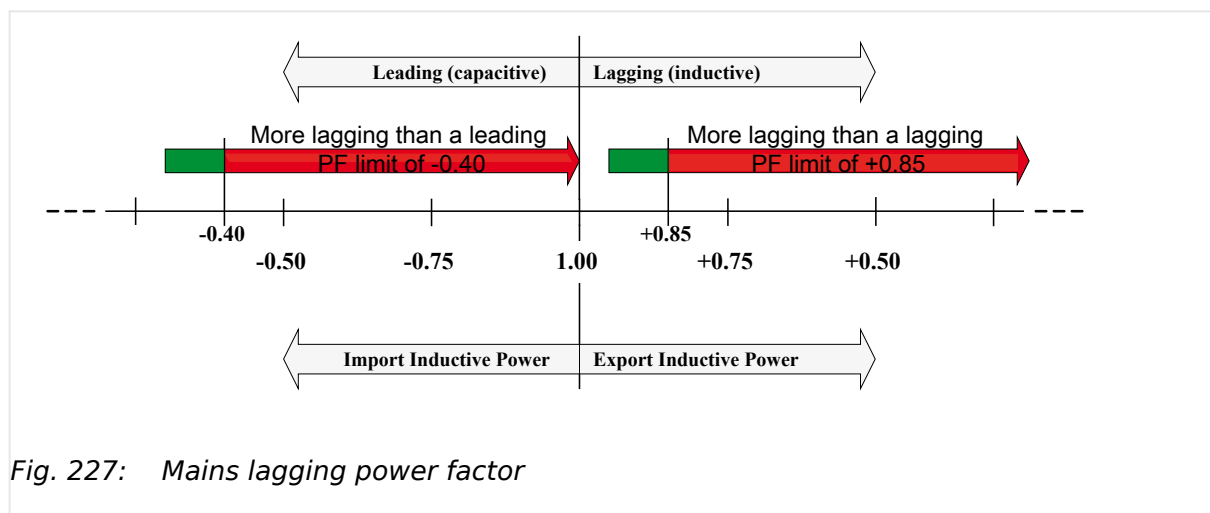

Fig. 227: Mains lagging power factor

Fig. 227 shows an example of a leading and a lagging power factor limit and the power factor range, for which the lagging power factor monitoring issues an alarm.



If this protective function is triggered, the display indicates "Mains PF lagging 1" or "Mains PF lagging 2" and the logical command variable "07.17" or "07.18" will be enabled.

4 Configuration

4.5.3.17 Mains Lagging Power Factor (Level 1 & 2)

ID	Parameter	CL	Setting range [Default]	Description
2975 2980	Monitoring	2	On	Mains lagging power factor monitoring is carried out according to the following parameters. Monitoring is performed at two levels. Both values may be configured independent from each other.
			[Off]	Monitoring is disabled for Level 1 limit and/or Level 2 limit.
2978 2983	Limit	2	-0.999 to 1.000 2978: [+ 0.900] 2983: [+ 0.800]	The values that are to be monitored for each threshold limit are defined here. Notes If the power factor becomes more lagging (i.e. inductive, ↗ Fig. 227) than a lagging PF value (pos.) or a leading PF value (neg.) for at least the delay time (parameters ↗ 2979 or ↗ 2984) without interruption, the logical command variables 07.17 (level 1) or 07.18 (level 2) are enabled and the action specified by the alarm class is initiated.
2989 2990			Hysteresis	2
2979 2984	Delay	2	0.02 to 99.99 s 2979: [30.00 s] 2984: [1.00 s]	If the monitored generator power factor is more lagging than the configured limit for the delay time configured here, an alarm will be issued. Notes If the monitored generator power factor returns within the limit (minus the Hysteresis configured in parameter ↗ 2989 or ↗ 2990) before the delay expires the time will be reset.
2987 2988			Alarm class	2
2976 2981	Self acknowledge	2	Yes	The control unit automatically clears the alarm if the fault condition is no longer detected.
		4	[No]	The control unit does not automatically reset the alarm when the fault condition is no longer detected.

ID	Parameter	CL	Setting range [Default]	Description
				The alarm must be acknowledged and reset by manually pressing the appropriate buttons or by activating the LogicsManager output "External acknowledgment" (via a discrete input or via an interface).
2977	Enabled	2	[Always]	Monitoring for this fault condition is continuously enabled.
2982			87.70 LM:Eng.mon	Monitoring for fault conditions is not performed until engine monitoring is enabled. This is determined through the LogicsManager equation "Release engine monitoring".
			For xx = 1 to 32: 96.{xx} LM: Flag{xx}	The monitoring is executed, if the LogicsManager "Flag {xx}" is TRUE. Example: 96.01 LM: Flag 1, 96.02 LM: Flag 2, ..., 96.32 LM: Flag 32

4.5.3.18 Mains Leading Power Factor (Level 1 & 2)

General notes

The power factor is monitored for becoming more leading (i.e. capacitive) than an adjustable limit. This limit may be a leading or lagging power factor limit. There are two leading power factor alarm levels available in the control. This monitoring function may be used for monitoring or controlling the power factor compensation. Both alarms are definite time alarms.

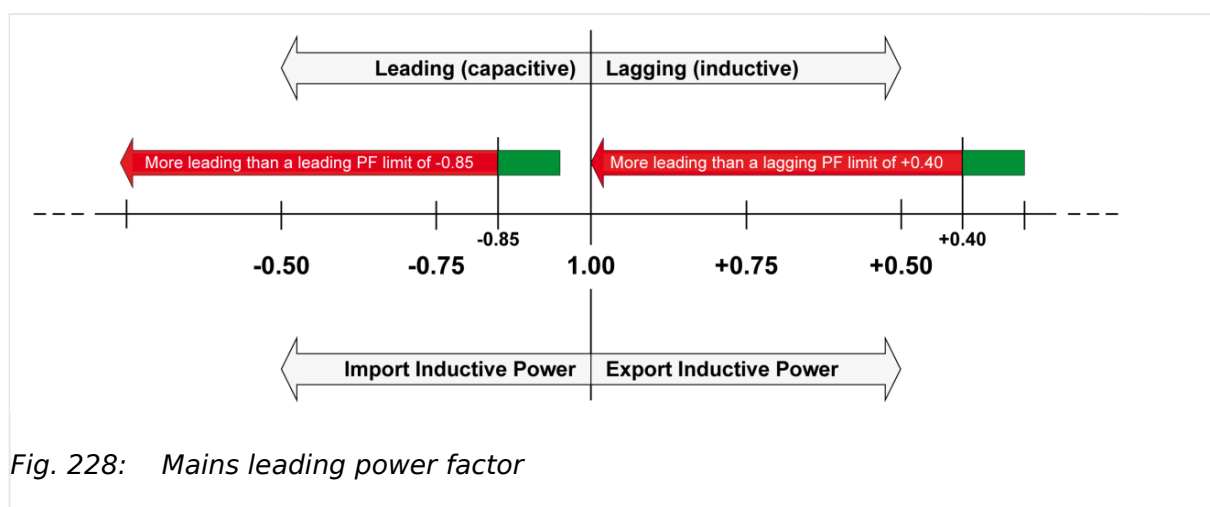

Fig. 228: Mains leading power factor

Fig. 228 shows an example of a leading and a lagging power factor limit and the power factor range, for which the leading power factor monitoring issues an alarm.



If this protective function is triggered, the display indicates "Mains PF leading 1" or "Mains PF leading 2" and the logical command variable "07.19" or "07.20" will be enabled.

ID	Parameter	CL	Setting range [Default]	Description
3025 3030	Monitoring	2	On	Mains leading power factor monitoring is carried out according to the following parameters. Monitoring is performed at two levels. Both values may be configured independent from each other.
			[Off]	Monitoring is disabled for Level 1 limit and/or Level 2 limit.
3028 3033	Limit	2	-0.999 to 01.000 3028: [- 0.900] 3033: [- 0.800]	The values that are to be monitored for each threshold limit are defined here. Notes If the power factor becomes more leading (i.e. inductive, ↩ Fig. 228) than a leading PF value (pos.) or a leading PF value (neg.) for at least the delay time (parameters ↩ 3029 or ↩ 3034) without interruption, the logical command variables 07.17 (level 1) or 07.18 (level 2) are enabled and the action specified by the alarm class is initiated.
3039 3040			Hysteresis	2
3029 3034	Delay	2	0.02 to 99.99 s 3029: [10.00 s] 3034: [1.00 s]	If the monitored generator power factor is more leading than the configured limit for the delay time configured here, an alarm will be issued. Notes If the monitored generator power factor returns within the limit (minus the Hysteresis configured in parameter ↩ 3039 or ↩ 3033) before the delay expires the time will be reset.
3037 3038			Alarm class	2

ID	Parameter	CL	Setting range [Default]	Description
3026 3031	Self acknowledge	2	Yes	The control unit automatically clears the alarm if the fault condition is no longer detected.
		4	[No]	The control unit does not automatically reset the alarm when the fault condition is no longer detected. The alarm must be acknowledged and reset by manually pressing the appropriate buttons or by activating the LogicsManager output "External acknowledgment" (via a discrete input or via an interface).
3027 3032	Enabled	2	[Always]	Monitoring for this fault condition is continuously enabled.
			87.70 LM:Eng.mon	Monitoring for fault conditions is not performed until engine monitoring is enabled. This is determined through the LogicsManager equation "Release engine monitoring".
			For xx = 1 to 32: 96.{xx} LM: Flag{xx}	The monitoring is executed, if the LogicsManager "Flag {xx}" is TRUE. Example: 96.01 LM: Flag 1, 96.02 LM: Flag 2, ..., 96.32 LM: Flag 32

4.5.4 Breaker

4.5.4.1 Configure GCB

General notes

Circuit breaker monitoring contains two alarms: A "breaker reclose" alarm and a "breaker open" alarm.

"Breaker reclose alarm"

If the control initiates a close of the breaker and the breaker fails to close after the configured number of attempts the monitoring CB alarm will be initiated (refer to parameter "GCB maximum closing attempts", parameter ↩️ 3418).



If this protective function is triggered, the display indicates "GCB fail to close" and the logical command variable "08.05" will be enabled.

"Breaker open alarm"

If the control is attempting to open the circuit breaker and it fails to see that the CB is open within the configured time in seconds after issuing the breaker open command then the monitoring CB alarm will be initiated (refer to parameter "GCB open monitoring", parameter [↩➤ 3420](#)).

NOTICE!



If load-dependent start/stop (refer to [↩➤ "4.4.5.5 Load Dependent Start/Stop \(LDSS\)"](#)) is enabled, this monitoring function must be configured with a shutdown alarm class C, D, E, or F) or disable load-dependent start/stop if triggered to ensure that the next engine will be started.



If this protective function is triggered, the display indicates "GCB fail to open" and the logical command variable "08.06" will be enabled.

ID	Parameter	CL	Setting range [Default]	Description
2600	GCB monitoring	2	[On]	Monitoring of the GCB is carried out according to the following parameters.
			Off	Monitoring is disabled.
2601	GCB alarm class	2	Class A, Class B, Class C, Class D, Class E, Class F , Control [Class B]	Each limit may be assigned an independent alarm class that specifies what action should be taken when the limit is surpassed.
				Notes For additional information refer to ↩➤ "9.5.4 Alarm Classes"
3418	GCB maximum closing attempts	2	1 to 10 [5]	The maximum number of breaker closing attempts is configured in this parameter (relay output "Command: close GCB"). When the breaker reaches the configured number of attempts, a "GCB fail to close" alarm is issued. The counter for the closure attempts will be reset as soon as the "Reply GCB" is de-energized for at least 5 seconds to signal a closed GCB.
3420	GCB open monitoring	2	0.10 to 5.00 s [2.00 s]	If the "Reply GCB" is not detected as energized once this timer expires, a "GCB fail to open" alarm is issued. This timer initiates as soon as the "open breaker" sequence begins. The alarm configured in parameter ↩➤ 2601 is issued.

4.5.4.2 Configure GCB 50BF

General notes

50BF is a breaker monitoring function which is tripping if the breaker reply is indicating an open breaker but there is still a current measured which is exceeding a configurable threshold. It is a kind of plausibility check between breaker reply and measurement.



This monitoring function is only working if the measured current is below 320% of rated current.

ID	Parameter	CL	Setting range [Default]	Description
1929	Monitoring	2	[On]	Monitoring of the GCB 50BF is carried out according to the following parameters.
			Off	Monitoring is disabled.
1930	Limit	2	2 to 100% [2%]	If the average generator current has reached or exceeded this limit for at least the delay time without interruption and the breaker reply indicates open, the action specified by the alarm class is initiated.
1931	Delay	2	0.02 to 99.90 s [0.20 s]	If the conditions are fulfilled for the time configured here, an alarm will be issued. The message "GCB failure 50BF" is issued and the logical command variable "08.46" will be enabled.
1932	Alarm class	2	Class A, Class B, Class C, Class D, Class E, Class F , Control [Class B]	Each limit may be assigned an independent alarm class that specifies what action should be taken when the limit is surpassed.
				Notes For additional information refer to ↳ "9.5.4 Alarm Classes"
1933	Self acknowledge	2	Yes	The control unit automatically clears the alarm if the fault condition is no longer detected.
			[No]	The control unit does not automatically reset the alarm when the fault condition is no longer detected. The alarm must be acknowledged and reset by manually pressing the appropriate buttons or by activating the LogicsManager output "External acknowledgment" (via a discrete input or via an interface).
1939	Enabled	2	[Always]	Monitoring for this fault condition is continuously enabled.

ID	Parameter	CL	Setting range [Default]	Description
			87.70LM:Eng.mon	Monitoring for fault conditions is not performed until engine monitoring is enabled. This is determined through the LogicsManager equation "Release engine monitoring".
			For xx = 1 to 32:96.{xx}LM: Flag{xx}	The monitoring is executed, if the LogicsManager "Flag {xx}" is TRUE. Example: 96.01 LM: Flag 1, 96.02 LM: Flag 2, ..., 96.32 LM: Flag 32

4.5.4.3 Synchronization GCB

General notes

NOTICE!



If load-dependent start/stop (refer to [4.4.5.5 Load Dependent Start/Stop \(LDSS\)](#)) is enabled, this monitoring function must be configured with a shutdown alarm class C, D, E, or F) or disable load-dependent start/stop if triggered to ensure that the next engine will be started.

ID	Parameter	CL	Setting range [Default]	Description
3060	Monitoring	2	[On]	Monitoring of the GCB synchronization is carried out according to the following parameters.
			Off	Monitoring is disabled.
3063	Delay	2	3 to 999 s [60 s]	If it was not possible to synchronize the GCB within the time configured here, an alarm will be issued. The message "GCB syn. timeout" is issued and the logical command variable "08.30" will be enabled.
3061	Alarm class	2	Class A, Class B, Class C, Class D, Class E, Class F, Control [Class B]	Each limit may be assigned an independent alarm class that specifies what action should be taken when the limit is surpassed.
				Notes For additional information refer to 9.5.4 Alarm Classes
3062	Self acknowledge	2	Yes	The control unit automatically clears the alarm if the fault condition is no longer detected.
			[No]	The control unit does not automatically reset the alarm when the fault condition is no longer detected.

ID	Parameter	CL	Setting range [Default]	Description
				The alarm must be acknowledged and reset by manually pressing the appropriate buttons or by activating the LogicsManager output "External acknowledgment" (via a discrete input or via an interface).

4.5.4.4 Configure GGB

General notes



All parameters listed below only apply to application mode **A05**, **A06**, **A09**, **A10**, **A11** and **A12**.

Circuit breaker monitoring contains two alarms: A breaker reclose alarm and a breaker open alarm.

"Breaker reclose alarm"

If the control unit initiates a close of the breaker and the breaker fails to close after the configured number of attempts the monitoring CB alarm will be initiated.

- Refer to parameter "GGB maximum closing attempts", parameter [↩ 3087](#).



If this protective function is triggered, the display indicates "GGB fail to close" and the logical command variable "08.34" will be enabled.

"Breaker open alarm"

If the control unit is attempting to open the circuit breaker and it fails to see that the CB is open within the configured time in seconds after issuing the breaker open command then the monitoring CB alarm will be initiated.

- Refer to parameter "GGB open monitoring", parameter [↩ 3088](#).



If this protective function is triggered, the display indicates "GGB fail to open" and the logical command variable "08.35" will be enabled.

ID	Parameter	CL	Setting range [Default]	Description
3085	GGB monitoring	2	[On]	Monitoring of the GGB is carried out according to the following parameters.
			Off	Monitoring is disabled.

4 Configuration

4.5.4.5 Synchronization GGB

ID	Parameter	CL	Setting range [Default]	Description
3086	GGB alarm class	2	Class A, Class B, Class C, Class D, Class E, Class F , Control [Class B]	Each limit may be assigned an independent alarm class that specifies what action should be taken when the limit is surpassed.
				Notes For additional information refer to ↳ "9.5.4 Alarm Classes"
3087	GGB maximum closing attempts	2	1 to 10 [5]	<p>The maximum number of breaker closing attempts is configured in this parameter (relay output "Command: close GGB").</p> <p>When the breaker reaches the configured number of attempts, an "GGB fail to close" alarm is issued.</p> <p>The counter for the closure attempts will be reset as soon as the "Reply GGB" is de-energized for at least 5 seconds to signal a closed GGB.</p>
3088	GGB open monitoring	2	0.10 to 5.00 s [2.00 s]	<p>If the "Reply GGB" is not detected as energized once this timer expires, an "GGB fail to open" alarm is issued.</p> <p>This timer initiates as soon as the "open breaker" sequence begins. The alarm configured in parameter ↳ 3086 is issued.</p>

4.5.4.5 Synchronization GGB

ID	Parameter	CL	Setting range [Default]	Description
3080	Monitoring	2	On	Monitoring of the GGB synchronization is carried out according to the following parameters.
			[Off]	Monitoring is disabled.
3083	Delay	2	3 to 999 s [30 s]	<p>If it was not possible to synchronize the GGB within the time configured here, an alarm will be issued.</p> <p>The message "GGB syn. timeout" is issued and the logical command variable "08.32" will be enabled.</p>
3081	Alarm class	2	Class A, Class B, Class C, Class D, Class E, Class F , Control [Class B]	Each limit may be assigned an independent alarm class that specifies what action should be taken when the limit is surpassed.
				Notes

ID	Parameter	CL	Setting range [Default]	Description
				For additional information refer to ↩> "9.5.4 Alarm Classes"
3082	Self acknowledge	2	Yes	The control unit automatically clears the alarm if the fault condition is no longer detected.
			[No]	The control unit does not automatically reset the alarm when the fault condition is no longer detected. The alarm must be acknowledged and reset by manually pressing the appropriate buttons or by activating the LogicsManager output "External acknowledgment" (via a discrete input or via an interface).

4.5.4.6 Configure MCB

General notes



If an alarm is detected when attempting to close the MCB, an emergency power operation will be carried out if the "Emergency start with MCB failure" is "On".

If an alarm class higher than 'B' class has been selected it will not be possible to start the engine with the setting "Emergency start with MCB failure" (parameter [↩> 3408](#)) = configured as "On" in an emergency power condition.



All parameters listed below only apply to application mode **A04**, **A06**, **A08**, **A09**, and **A11**.

Circuit breaker monitoring contains two alarms: A breaker reclose alarm and a breaker open alarm.

"Breaker reclose alarm"

If the control unit initiates a close of the breaker and the breaker fails to close after the configured number of attempts the monitoring CB alarm will be initiated.

- Refer to parameter "MCB maximum closing attempts", parameter [↩> 3419](#).



If this protective function is triggered, the display indicates "MCB fail to close" and the logical command variable "08.07" will be enabled.

"Breaker open alarm"

If the control unit is attempting to open the circuit breaker and it fails to see that the CB is open within the configured time in seconds after issuing the breaker open command then the monitoring CB alarm will be initiated.

- Refer to parameter "MCB open monitoring", parameter [↩➤ 3421](#).



If this protective function is triggered, the display indicates "MCB fail to open" and the logical command variable "08.08" will be enabled.

Fault at 'closing the MCB'

Alarm classes A & B

- Parameter [↩➤ 2802](#) "Emergency run" = Off;

If the MCB cannot be closed, the busbar remains without voltage, until the MCB breaker fault is acknowledged.

The control continues attempting to close the MCB.

- Parameter [↩➤ 2802](#) "Emergency run" = On, parameter [↩➤ 3408](#) "Emergency start with MCB failure" = Off;

If the MCB cannot be closed, the busbar remains without voltage, until the MCB breaker fault is acknowledged.

The control continues attempting to close the MCB.

- Parameter [↩➤ 2802](#) "Emergency run" = On, parameter [↩➤ 3408](#) "Emergency start with MCB failure" = On;

If the MCB cannot be closed, an emergency power operation is initiated (the engine is started and the GCB is closed; the busbar is supplied by the generator).

If the alarm is acknowledged and if the MCB can be closed, the load is switched to mains supply and the emergency power operation terminates.

Fault at 'opening the MCB'

This alarm class has the following influence to the function of the unit:

- This fault is processed according to the action described within the alarm classes. As long as the reply is present that the MCB is still closed, the GCB cannot be closed.

ID	Parameter	CL	Setting range [Default]	Description
2620	MCB monitoring	2	[On]	Monitoring of the MCB is carried out according to the following parameters.
			Off	Monitoring is disabled.
2621	MCB alarm class	2	Class A, Class B, Class C, Class D, Class E, Class F , Control [Class B]	Each limit may be assigned an independent alarm class that specifies what action should be taken when the limit is surpassed.
				Notes

ID	Parameter	CL	Setting range [Default]	Description
				For additional information refer to ↗ "9.5.4 Alarm Classes"
3419	MCB maximum closing attempts	2	1 to 10 [5]	<p>The maximum number of breaker closing attempts is configured in this parameter (relay output "Command: close MCB").</p> <p>When the breaker reaches the configured number of attempts, an "MCB fail to close" alarm is issued.</p> <p>The counter for the closure attempts will be reset as soon as the "Reply MCB" is de-energized for at least 5 seconds to signal a closed MCB.</p>
3421	MCB open monitoring	2	0.10 to 5.00 s [2.00 s]	<p>If the "Reply MCB" is not detected as energized once this timer expires, an "MCB fail to open" alarm is issued.</p> <p>This timer initiates as soon as the "open breaker" sequence begins. The alarm configured in parameter ↗ 2621 is issued.</p>

4.5.4.7 Synchronization MCB

ID	Parameter	CL	Setting range [Default]	Description
3070	Monitoring	2	[On]	Monitoring of the MCB synchronization is carried out according to the following parameters.
			Off	Monitoring is disabled.
3073	Delay	2	3 to 999 s [60 s]	<p>If it was not possible to synchronize the MCB within the time configured here, an alarm will be issued.</p> <p>The message "MCB syn. timeout" is issued and the logical command variable "08.31" will be enabled.</p>
3071	Alarm class	2	Class A, Class B, Class C, Class D, Class E, Class F, Control [Class B]	Each limit may be assigned an independent alarm class that specifies what action should be taken when the limit is surpassed.
				<p>Notes</p> <p>For additional information refer to ↗ "9.5.4 Alarm Classes"</p>
3072	Self acknowledge	2	Yes	The control unit automatically clears the alarm if the fault condition is no longer detected.

ID	Parameter	CL	Setting range [Default]	Description
			[No]	<p>The control unit does not automatically reset the alarm when the fault condition is no longer detected.</p> <p>The alarm must be acknowledged and reset by manually pressing the appropriate buttons or by activating the LogicsManager output "External acknowledgment" (via a discrete input or via an interface).</p>

4.5.4.8 Configure MCB 50BF

50BF is a breaker monitoring function which is tripping if the breaker reply is indicating an open breaker but there is still a current measured which is exceeding a configurable threshold. It is a kind of plausibility check between a breaker reply and a measurement.



This monitoring function is only working if the measured current is below 320% of rated current!

ID	Parameter	CL	Setting range [Default]	Description
1934	Monitoring	2	[Off]	Monitoring is disabled.
			On	Monitoring of the MCB 50BF is carried out according to the following parameters.
1935	Limit	2	2 to 100% [2%]	If the mains current has reached or exceeded this limit for at least the delay time without interruption and the breaker reply indicates open, the action specified by the alarm class is initiated.
1936	Delay	2	3 to 999 s [60 s]	<p>If the conditions are fulfilled for the time configured here, an alarm will be issued.</p> <p>The message "MCB failure 50BF" is issued and the logical command variable "08.47" will be enabled.</p>
1937	Alarm class	2	Class A, Class B, Class C, Class D, Class E, Class F, Control [Class B]	Each limit may be assigned an independent alarm class that specifies what action should be taken when the limit is surpassed.
				<p>Notes</p> <p>For additional information refer to "9.5.4 Alarm Classes"</p>

ID	Parameter	CL	Setting range [Default]	Description
1938	Self acknowledge	2	Yes	The control unit automatically clears the alarm if the fault condition is no longer detected.
			[No]	The control unit does not automatically reset the alarm when the fault condition is no longer detected. The alarm must be acknowledged and reset by manually pressing the appropriate buttons or by activating the LogicsManager output "External acknowledgment" (via a discrete input or via an interface).
1940	Enabled	2	[Always]	Monitoring for this fault condition is continuously enabled.
			87.70LM:Eng.mon	Monitoring for fault conditions is not performed until engine monitoring is enabled. This is determined through the LogicsManager equation "Release engine monitoring".
			For xx = 1 to 32: 96.{xx} LM: Flag{xx}	The monitoring is executed, if the LogicsManager "Flag {xx}" is TRUE. Example: 96.01 LM: Flag 1, 96.02 LM: Flag 2, ..., 96.32 LM: Flag 32

4.5.4.9 MCB plausibility



If breaker mode GCB/MCB is configured, this alarm trips (according to the monitor settings) if the number of closed MCBs is different to the number of easYgen devices in the same segment.

ID	Parameter	CL	Setting range [Default]	Description
1941	Monitoring	2	[Off]	Monitoring is disabled.
			On	Monitoring of the MCB plausibility is carried out according to the following parameters.
1942	Delay	2	0.02 to 99.90 s [0.20 s]	If the conditions are fulfilled for this time the alarm "MCB plausibility" will trip and the command variable 08.48 becomes active.
1943	Alarm class	2	Class A, Class B, Class C, Class D, Class E, Class F , Control [Class B]	An alarm can be assigned that specifies what action should be taken when the conditions are fulfilled.
				Notes

ID	Parameter	CL	Setting range [Default]	Description
				For additional information refer to ↳ "9.5.4 Alarm Classes"
1944	Self acknowledge	2	Yes	The control unit automatically clears the alarm if the fault condition is no longer detected.
			[No]	The control unit does not automatically reset the alarm when the fault condition is no longer detected. The alarm must be acknowledged and reset by manually pressing the appropriate buttons or by activating the LogicsManager output "External acknowledgment" (via a discrete input or via an interface).
1945	Enabled	2	[Always]	Monitoring for this fault condition is continuously enabled.
			87.70 LM:Eng.mon	Monitoring for fault conditions is not performed until engine monitoring is enabled. This is determined through the LogicsManager equation "Release engine monitoring".
			For xx = 1 to 32: 96.{xx} LM: Flag{xx}	The monitoring is executed, if the LogicsManager "Flag {xx}" is TRUE. Example: 96.01 LM: Flag 1, 96.02 LM: Flag 2, ..., 96.32 LM: Flag 32

4.5.4.10 Configure Neutral Contactor

General notes

The monitoring of the Neutral Contactor (NC) feedback "17.09 N-cont. reply mism." is performed always, if the Neutral Interlocking (parameter [↳ 1840](#)) and the Monitoring function are enabled (parameter [↳ 5148](#)). The monitor checks, if the feedback behaves according to the NC command. With a configurable delay time, the alarm is activated with a general alarm text. Open failure or closure failure are not differentiated.

Please refer to [↳ "6.3.15 Neutral Interlocking"](#) for more details.



This function is not usable in the application mode "GCB/GC" **A15**.

ID	Parameter	CL	Setting range [Default]	Description
5148	Monitoring	2	On	Monitoring of the Neutral Contactor is carried out according to the following parameters, if the Neutral Interlocking function (parameter ↳ 1840) is enabled .

ID	Parameter	CL	Setting range [Default]	Description
			[Off]	Monitoring is disabled.
5152	Delay	2	0.10 to 5.00 s [2.00 s]	Period of continuous failure signal before tripping a failure.
5149	Alarm class	2	Class A, Class B, Class C, Class D, Class E, Class F , Control [Class B]	This function may be assigned an independent alarm class that specifies what action should be taken when this function triggers an alarm. Notes For additional information refer to 9.5.4 Alarm Classes .
5150	Self acknowledge	2	Yes	The control automatically clears the alarm if the fault condition is no longer detected.
			[No]	The control does not automatically reset the alarm when the fault condition is no longer detected. The alarm must be acknowledged and reset by manually pressing the appropriate buttons or by activating the LogicsManager output "External acknowledgment" (via a discrete input or via an interface).
5153	N-cont. reply mism.	-	[N-cont. reply mism.]	Text is visible in display during alarm is detected.

4.5.5 Flexible Limits

General notes

CAUTION!



Hazards due to improper configuration of protective functions

Flexible Limits must not be used for protective functions, because the monitoring function is not guaranteed beyond an exceeding of 320 %.



It is not possible to monitor temperature values in Degree Fahrenheit and pressure values in psi. Although parameters [3631](#) or [3630](#) are configured to a value display in °F or psi, flexible limit monitoring always refers to the value in Degree Celsius or bar (J1939 protocol: kPa).

This control unit offers 40 flexible limits. They may be used for "limit switch" functions of all measured analog values. It is possible to choose between alarm (warning and shutdown) and control operation via the LogicsManager.

If an alarm class is triggered, the display indicates "Flexible limit {x}", where {x} indicates the flexible limit 1 to 40, or the text configured using ToolKit and the logical command variable "15.{x}" will be enabled.



The flexible limits 25 through 32 are configurable additionally with a 'Fallback time' e.g., for load shedding.



The flexible limits 33 through 40 are disabled during idle mode operation (refer to [4.4.1.4 Idle Mode](#) ).

The following parameter description refers to flexible limit 1. The flexible limits 2 through 40 are configured accordingly. The parameter IDs of the flexible limits 2 through 40 are listed below.

ID	Parameter	CL	Setting range [Default]	Description
4208	Description	2	user defined (up to 39 characters)	 <p>A description for the respective flexible limit may be entered here. The description may have 4 through 20 characters and is displayed instead of the default text if this limit is exceeded.</p> <p>Notes</p> <p>This parameter may only be configured using ToolKit. 19 characters are best for HMI readability - text strings with 20 and more characters but without a blank in between are NOT visible as headline on detail screen. Selection screen on HMI/display works fine with up to 30 characters; others are overwritten by mandatory screen symbols.</p> <p>The max. number of characters depends on the numbers of Bytes for each character.</p> <p>Please verify the length on the display for best view.</p>
			[Flex. limit {x}]	
4200	Monitoring	2	On	Monitoring of the limit {x} is carried out according to the following parameters.
			[Off]	Monitoring is disabled.
4204	Monitoring at	2	[Overrun]	The monitored value must exceed the threshold limit for a fault to be recognized.
			Underrun	The monitored value must fall below the threshold limit for a fault to be recognized.
4205	Limit	2	-21000000.00 to 21000000.00	The threshold limit of the value to be monitored is defined by this

ID	Parameter	CL	Setting range [Default]	Description
			[100.00]	<p>parameter. If this value is reached or exceeded / fallen below (dependent on parameter ↪ 4204) for at least the delay time configured in parameter ↪ 4207 the action specified by the alarm class is initiated after the configured delay expires.</p> <p>The entry format of the threshold depends on the respective analog value.</p> <p>If the monitored analog value has a reference value, the threshold is expressed as a percentage of this reference value.</p> <p>Notes</p> <p>Refer to ↪ “Examples” for examples on how to configure the limit.</p>
4216	Hysteresis	2	0.00 to 21000000.00 [1.00]	<p>During monitoring, the actual value must exceed or fall below one of the limits defined in parameter ↪ 4205 to be recognized as out of permissible limits. For a value to register as having returned to the permissible limits, the monitored value must rise above or fall below this value for the hysteresis.</p> <p>The format for entering the hysteresis depends on the monitored analog input and corresponds with the one of the threshold listed in parameter ↪ 4205.</p>
4207	Delay	2	0.02 to 99999.99 s [1.00 s]	<p>If the monitored value exceeds or falls below the threshold value for the delay time configured here, an alarm will be issued. If the monitored value falls below the threshold (plus/minus the hysteresis, dependent on parameter ↪ 4204) before the delay expires the time will be reset.</p>
<i>Beginning: For flexible limit 25 ... 32 only; sample refers to flexible limit #25.</i>				
6646	Fallback time	2	00.02 to 99999.99 s [1.00 s]	<p>If the monitored value exceeds or falls below the threshold value, a counter will start and finally disable the alarm. If the monitored value comes back into the threshold value (plus/minus the hysteresis) before the fallback time expires the time will be reset.</p>
<i>End: For flexible limit 25 ... 32 only; sample referred to flexible limit #25.</i>				
4201	Alarm class	2	Class A, Class B, Class C, Class D, Class E, Class F , Control	<p>Each limit may be assigned an independent alarm class that specifies what action should be taken when the limit is surpassed.</p>

ID	Parameter	CL	Setting range [Default]	Description
			[Class B]	
				Notes For additional information refer to ↪ "9.5.4 Alarm Classes"
4202	Self acknowledge	2	Yes	The control unit automatically clears the alarm if the fault condition is no longer detected.
			[No]	The control unit does not automatically reset the alarm when the fault condition is no longer detected. The alarm must be acknowledged and reset by manually pressing the appropriate buttons or by activating the LogicsManager output "External acknowledgment" (via a discrete input or via an interface).
4203	Enabled	2	[Always]	Monitoring for this fault condition is continuously enabled.
			87.70 LM:Eng.mon	Monitoring for fault conditions is not performed until engine monitoring is enabled. This is determined through the LogicsManager equation "Release engine monitoring".
			For xx = 1 to 32: 96.{xx} LM: Flag{xx}	The monitoring is executed, if the LogicsManager "Flag {xx}" is TRUE. Example: 96.01 LM: Flag 1, 96.02 LM: Flag 2, ..., 96.32 LM: Flag 32
4206	AM FlexLim 1 source	2	Determined by AnalogManager 82.01 [A1 = 10.01 ZERO]	Any possible data sources may be selected. Analog and digital OUT value/signal are available as sources for AnalogManager and LogicsManager. Refer to ↪ "9.4.2 Data Sources AM" for a list of all data sources.

Parameter IDs

Flexible limit #	Description	Monitoring	Monitor- ed analog value	Monitor- ing at	Limit	Hyster- esis	Delay	Alarm class	Self acknow- ledge	Enabled
							Fallback			
1	4208	4200	4206	4204	4205	4216	4207	4201	4202	4203
2	4225	4217	4223	4221	4222	4233	4224	4218	4219	4220
3	4242	4234	4240	4238	4239	4250	4241	4235	4236	4237
4	4259	4251	4257	4255	4256	4267	4258	4252	4253	4254

Flexible limit #	Description	Monitoring	Monitored analog value	Monitoring at	Limit	Hysteresis	Delay	Alarm class	Self acknowledge	Enabled
							Fallback			
5	7108	4270	4276	4274	4275	4278	4277	4271	4272	4273
6	7116	4280	4286	4284	4285	4288	4287	4281	4282	4283
7	7124	4290	4296	4294	4295	4298	4297	4291	4292	4293
8	7132	6000	6006	6004	6005	6008	6007	6001	6002	6003
9	7140	6010	6016	6014	6015	6018	6017	6011	6012	6013
10	7148	6020	6026	6024	6025	6028	6027	6021	6022	6023
11	7156	6030	6036	6034	6035	6038	6037	6031	6032	6033
12	7164	6040	6046	6044	6045	6048	6047	6041	6042	6043
13	7172	6050	6056	6054	6055	6058	6057	6051	6052	6053
14	7180	6060	6066	6064	6065	6068	6067	6061	6062	6062
15	7188	6070	6076	6074	6075	6078	6077	6071	6072	6073
16	7196	6080	6086	6084	6085	6088	6087	6081	6082	6083
17	7204	6090	6096	6094	6095	6098	6097	6091	6092	6093
18	7212	6100	6106	6104	6105	6108	6107	6101	6102	6103
19	7220	6110	6116	6114	6115	6118	6117	6111	6112	6113
20	7228	6120	6126	6124	6125	6128	6127	6121	6122	6123
21	7236	6130	6136	6134	6135	6138	6137	6131	6132	6133
22	7244	6140	6146	6144	6145	6148	6147	6141	6142	6143
23	7252	6150	6156	6154	6155	6158	6157	6151	6152	6153
24	7260	6160	6166	6164	6165	6168	6167	6161	6162	6163
25	7268	6170	6176	6174	6175	6178	6177	6171	6172	6173
							6646			
26	7276	6180	6186	6184	6185	6188	6187	6181	6182	6183
							6647			
27	7284	6190	6196	6194	6195	6108	6197	6191	6192	6193
							6648			
28	7292	6200	6206	6204	6205	6208	6207	6201	6202	6203
							6649			
29	7300	6210	6216	6214	6215	6218	6217	6211	6212	6213
							6650			
30	7308	6220	6226	6224	6225	6228	6227	6221	6222	6223
							6651			
31	7316	6230	6236	6234	6235	6238	6237	6231	6232	6233
							6652			
32	7324	6240	6246	6244	6245	6248	6247	6241	6242	6243
							6653			

Flexible limit #	Description	Monitoring	Monitored analog value	Monitoring at	Limit	Hysteresis	Delay	Alarm class	Self acknowledge	Enabled
							Fallback			
33	7332	6250	6256	6254	6255	6258	6257	6251	6252	6253
34	7340	6260	6266	6264	6265	6268	6267	6261	6262	6263
35	7348	6270	6276	6274	6275	6278	6277	6271	6272	6273
36	7356	6280	6286	6284	6285	6288	6287	6281	6282	6283
37	7364	6290	6296	6294	6295	6298	6297	6291	6292	6293
38	7372	6300	6306	6304	6305	6308	6307	6301	6302	6303
39	7380	6310	6316	6314	6315	6318	6317	6311	6312	6313
40	7388	6320	6326	6324	6325	6328	6327	6321	6322	6323

Table 80: Flexible limits - parameter IDs

Examples

Example value	Desired limit	Reference value / display value	Limit entry format
01.24 Gen.act.power [%]	160 kW	Gen. rated active power [kW] (parameter ↩ 1752) = 200 kW	80.00
01.09 Gen.frequency [%]	51.5 Hz	System rated frequency (parameter ↩ 1750) = 50Hz	103.00
11.01 Engine speed [%]	1256 rpm	Engine rated speed (parameter ↩ 1601) = 1500 rpm	83.73
06.03 Analog input 3 (configured to VDO 5bar)	4.25 bar	Display in 0.01 bar	4.25
06.02 Analog input 2 (configured to VDO 150°C)	123 °C	Display in 0.01°C	123.00
06.03 Analog input 3 (configured to "Linear" e.g. for tank level 0 - 100 %, "User defined min display value" = 0, "User defined max display value" = 100)	20 %	Display in 0.00 %	20.00

Table 81: Flexible limits - analog value examples

The flexible limits must be used to monitor analog inputs like oil pressure or coolant temperature for example. We recommend to change the flexible limit description accordingly.

The table below gives some configuration examples. The analog inputs must be configured accordingly.

Parameter (Examples using "Flexible limit 1" and "Flexible limit 2 ")	Example for low oil pressure monitoring	Example for high coolant temperature monitoring
Description	Oil pressure	Coolant temperature
Monitoring	On	On

Parameter (Examples using "Flexible limit 1" and "Flexible limit 2 ")	Example for low oil pressure monitoring	Example for high coolant temperature monitoring
AM FlexLim 1 source / AM FlexLim 2 source	A1 = 06.01 Analog input 1 Type = Pass through	A1 = 06.02 Analog input 2 Type = Pass through
Monitoring at	Underrun	Overrun
Limit	2.00 (2.00 bar)	80.00 (80 °C)
Hysteresis	0.10 (0.10 bar)	2.00 (2 °C)
Delay	0.50 s	3 s
Alarm class	F	B
Self acknowledge	No	No
Enabled	Yes	No

Table 82: Flexible limits - configuration examples

4.5.6 Miscellaneous

4.5.6.1 General monitoring settings

ID	Parameter	CL	Setting range [Default]	Description
1756	Time until horn reset	0	0 to 1,000 s [180 s]	<p>After each alarm of alarm class B through F occurs, the alarm LED flashes and the horn (command variable 03.05) is enabled. After the delay time "time until horn reset" has expired, the horn (command variable 03.05) is disabled. The alarm LED flashes until the alarm has been acknowledged either via the push button, the LogicsManager, or the interface.</p> <p>Notes</p> <p>If this parameter is configured to 0, the horn will remain active until it will be acknowledged.</p>
12490	Ext. acknowledge (External acknowledgment of alarms)	2	Determined by LogicsManager 86.15 [(09.05 Discrete input 5 & 1) OR 04.14 Remote acknowledge] = 10714	<p>It is possible to acknowledge all alarms simultaneously from remote, e.g. with a discrete input. The logical output of the LogicsManager has to become TRUE twice.</p> <p>The first time is for acknowledging the horn, the second for all alarm messages. The On-delay time is the minimum time the input signals have to be "1". The Off-delay time is the time how long the input conditions have to be "0" before the next high signal is accepted.</p>

4 Configuration

4.5.6.1 General monitoring settings

ID	Parameter	CL	Setting range [Default]	Description
				<p>Once the conditions of the LogicsManager have been fulfilled the alarms will be acknowledged.</p> <p>The first high signal into the discrete input acknowledges the command variable 03.05 (horn).</p> <p>The second high signal acknowledges all inactive alarm messages.</p> <p>Notes</p> <p>For information on the LogicsManager and its default settings see ↩ “9.3.1 LogicsManager Overview”.</p>
1849	Stop mode with stopping alarm	2	<p>If operating mode is not fixed via LogicsManager (see chapter ↩ “6.3.5 Performing Remote Start/Stop And Acknowledgment” for details) with this parameter it can be decided if the operation mode changes to STOP mode when a shutdown alarm of class C, D, E, F occurs.</p>	<p>No</p> <p>A shut down alarm does not cause an operating mode change.</p> <p>This can be useful in applications with remote control, where the operator wants to acknowledge alarms and restart the engine without the need to change operating mode in the easYgen.</p> <p>Notes</p> <p>If the shut down alarm disappears, generator can start automatically!</p> <p>[Yes]</p> <p>Each shut down alarm (class C, D, E, F) will change operating mode to STOP.</p> <p>Notes</p> <p>LM ↩ 12510, ↩ 12520, ↩ 12530 do have priority.</p>
5775	IOP Delayed unload. Alarm C,E	2	<p>0 to 9999 s</p> <p>[0 s]</p>	<p>This parameter gives a load sharing participant the opportunity to delay the unload if an shutdown alarm of alarm class C or E occurs. The time gained gives another generator the chance to participate in the load sharing network.</p> <p>The time configured here delays the triggering of alarm class C and E. A setting of 0 s deactivates this function.</p> <p>Notes</p> <p>For additional information refer to ↩ “9.5.4 Alarm Classes”</p>

ID	Parameter	CL	Setting range [Default]	Description
2645	Shutdown execution delay	2	0.0 to 0.99 s [0.0 s]	<p>This parameter will delay the execution after an shutdown alarm (C, D, E or F) occurred.</p> <p>The shutdown alarms and the according LogicsManager flags are not delayed. That way it is possible to do load shedding before the GCB opens, for example.</p> <p>A setting of 0.0 s deactivates this function.</p> <p>Notes</p> <p>For additional information refer to “9.5.4 Alarm Classes”</p>

4.5.6.2 Free Configurable Alarms

General Notes

The easYgen-XT provides 16 freely configurable alarms.

Each alarm is configurable by:

- A LogicsManager equation
- Alarm text/description (configurable with ToolKit only)
- Delay time
- Alarm class
- Self acknowledgment
- Being enabled depending on Engine Monitoring LM 87.70 (selectable)

Free Alarm 1 for example

ID	Parameter	CL	Setting range [Default]	Description
8120	Free alarm 1	2	Determined by LogicsManager 88.01 [02.01 LM FALSE & 1 & 1] = 11550	<p>This LogicsManager is used to select the source of monitoring.</p> <p>Notes</p> <p>For information on the LogicsManager and its default settings see “9.3.1 LogicsManager Overview”.</p>
8121	Alarm class	2	Class A, Class B, Class C, Class D, Class E, Class F , Control [Class B]	The assigned independent alarm class specifies what action should be taken when the alarm becomes TRUE.

4 Configuration

4.5.6.2 Free Configurable Alarms

ID	Parameter	CL	Setting range [Default]	Description
8122	Self acknowledge	2	Yes / No	The control automatically clears the alarm if the fault condition is no longer detected.
			[No]	The control does not automatically clear the alarm if the fault condition is no longer detected. The alarm must be acknowledged and reset by manually pressing the appropriate buttons or by activating the LogicsManager output "External acknowledgment" (via a discrete input or via an interface).
8123	Enabled	2	[Always]	Monitoring for this fault condition is continuously enabled.
			87.70 LM:Eng.mon	Monitoring for fault conditions is not performed until engine monitoring is enabled. This is determined through the LogicsManager equation "Release engine monitoring".
			For xx = 1 to 32: 96.{xx} LM: Flag{xx}	The monitoring is executed, if the LogicsManager "Flag {xx}" is TRUE. Example: 96.01 LM: Flag 1, 96.02 LM: Flag 2, ..., 96.32 LM: Flag 32
8236	Delay	2	0.02 to 99999.99 s	Period before alarm becomes TRUE.
			[1.00 s]	
6680	Description	2	[Free alarm 1]	Text is configurable by ToolKit.
			...((30 characters))*	Notes *) The max. number of characters is 48 but 30 characters can be read on easYgen HMI without restrictions.

Parameter IDs

Free alarm #	Description	Logics-Manager	Alarm class	Self acknowledge	Enabled	Delay
1	6680	8120	8121	8122	8123	8236
2	6681	8124	8125	8126	8127	8237
3	6682	8128	8129	8130	8131	8238
4	6683	8132	8133	8134	8135	8239
5	6688	8136	8137	8138	8139	8240
6	6689	8140	8141	8142	8143	8241
7	6690	8144	8145	8146	8147	8242
8	6691	8148	8149	8152	8153	8243

Free alarm #	Description	Logics-Manager	Alarm class	Self acknowledge	Enabled	Delay
9	6692	8154	8155	8156	8157	8244
10	6693	8158	8159	8161	8163	8245
11	6694	8165	8167	8168	8169	8246
12	6695	8170	8171	8172	8173	8247
13	6696	8174	8175	8176	8177	8248
14	6697	8178	8179	8180	8181	8249
15	6698	8182	8183	8184	8185	8250
16	6699	8186	8187	8188	8189	8251
17	1401	1402	1403	1404	1405	1406
18	1411	1412	1413	1414	1415	1416
19	1421	1422	1423	1424	1425	1426
20	1431	1432	1433	1434	1435	1436
21	1441	1442	1443	1444	1445	1446
22	1451	1452	1453	1454	1455	1456
23	1461	1462	1463	1464	1465	1466
24	1471	1472	1473	1474	1475	1476
25	8103	8104	8105	8106	8107	8108
26	8111	8112	8113	8114	8115	8116
27	8190	8191	8192	8193	8194	8195
28	8216	8217	8218	8219	8220	8221
29	8224	8225	8226	8227	8228	8229
30	8278	8279	8280	8281	8282	8283
31	8286	8287	8288	8289	8290	8291
32	8380	8381	8382	8383	8384	8385

Table 83: Free alarms - parameter IDs

4.5.6.3 CAN Interfaces

- CAN Interface 1: See [↪](#) “4.5.6.4 CAN Interface 1”.
- CAN Interface 2: See [↪](#) “4.5.6.5 CAN Interface 2”.

4.5.6.4 CAN Interface 1

General notes

The CANopen interface 1 is monitored. If the interface does not receive a Receive Process Data Object (RPDO) before the delay expires, an alarm will be initiated.



If this protective function is triggered, the display indicates "CANopen interface 1" and the logical command variable "08.18" will be enabled.

ID	Parameter	CL	Setting range [Default]	Description
3150	Monitoring	2	On	CANopen interface 1 monitoring is carried out according to the following parameters.
			[Off]	Monitoring is disabled.
3154	Delay	2	0.01 to 650.00 s [0.20 s]	The maximum receiving break is configured with this parameter. If the interface does not receive an RPDO within this time, the action specified by the alarm class is initiated. The delay timer is re-initialized after every message is received.
3151	Alarm class	2	Class A, Class B, Class C, Class D, Class E, Class F , Control [Class B]	Each limit may be assigned an independent alarm class that specifies what action should be taken when the limit is surpassed.
				Notes For additional information refer to ↗ "9.5.4 Alarm Classes"
3152	Self acknowledge	2	[Yes]	The control unit automatically clears the alarm if the fault condition is no longer detected.
			No	The control unit does not automatically reset the alarm when the fault condition is no longer detected. The alarm must be acknowledged and reset by manually pressing the appropriate buttons or by activating the LogicsManager output "External acknowledgment" (via a discrete input or via an interface).
3153	Enabled	2	[Always]	Monitoring for this fault condition is continuously enabled.
			87.70 LM:Eng.mon	Monitoring for fault conditions is not performed until engine monitoring is enabled. This is determined through the LogicsManager equation "Release engine monitoring".
			For xx = 1 to 32: 96.{xx} LM: Flag{xx}	The monitoring is executed, if the LogicsManager "Flag {xx}" is TRUE. Example:

ID	Parameter	CL	Setting range [Default]	Description
				96.01 LM: Flag 1, 96.02 LM: Flag 2, ..., 96.32 LM: Flag 32

4.5.6.5 CAN Interface 2

General notes

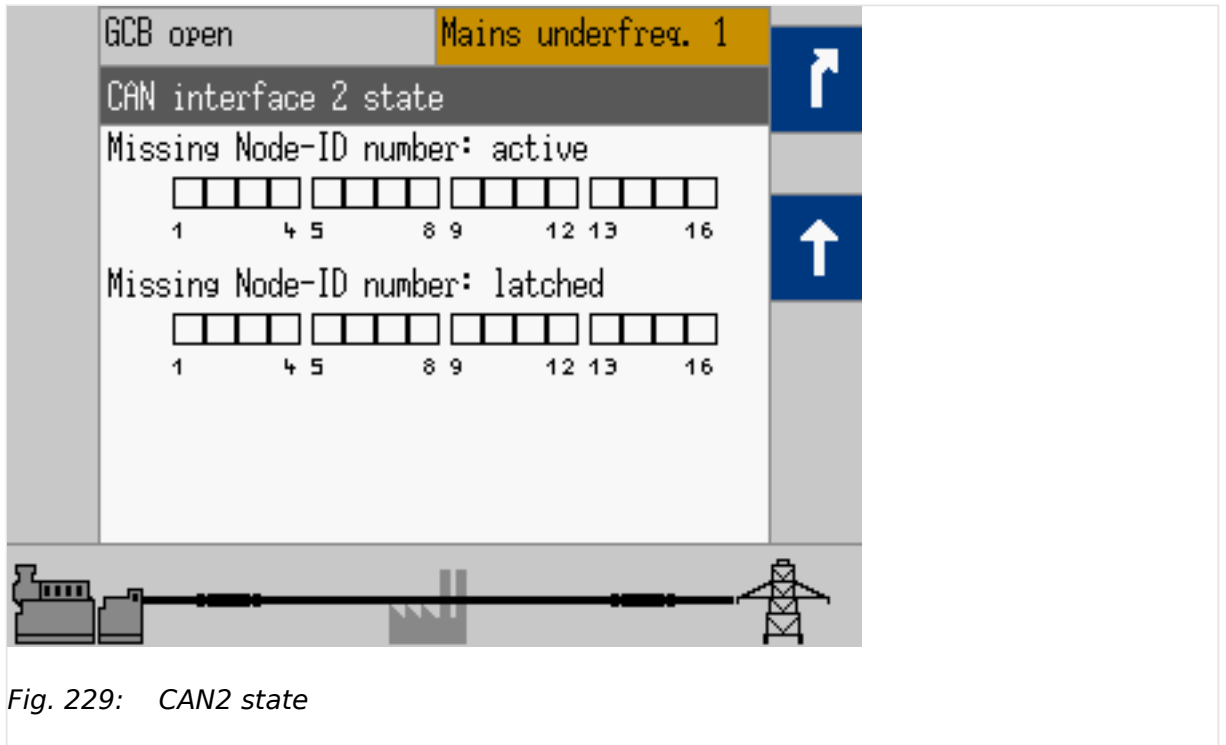

Fig. 229: CAN2 state

The CANopen interface 2 is monitored. If the interface does not receive a message from the external expansion board (Node-ID) before the delay expires, an alarm will be initiated.

This is indicated in the following menus:

HMI: [Next Page / Diagnostic / Interfaces / CAN / CAN 2 state]

ToolKit: [STATUS MENU / Diagnostic / Interfaces / CAN / CAN 2 state]



If this protective function is triggered, the display indicates "CANopen interface 2" and the logical command variable "08.19" will be enabled.



If you are not using the exact amount of external I/O modules you have defined, the monitoring function does not work correctly.

ID	Parameter	CL	Setting range [Default]	Description
16187	Monitoring	2	On	CANopen interface 2 monitoring is carried out according to the following parameters.
			[Off]	Monitoring is disabled.
16186	Delay	2	0.01 to 650.00 s [0.20 s]	The maximum receiving break is configured with this parameter. If the interface does not receive message from the external expansion board (Node-ID) within this time, the action specified by the alarm class is initiated. The delay timer is re-initialized after every message is received.
16188	Alarm class	2	Class A, Class B, Class C, Class D, Class E, Class F , Control [Class B]	Each limit may be assigned an independent alarm class that specifies what action should be taken when the limit is surpassed.
				Notes For additional information refer to ↪ "9.5.4 Alarm Classes"
16190	Self acknowledge	2	[Yes]	The control unit automatically clears the alarm if the fault condition is no longer detected.
			No	The control unit does not automatically reset the alarm when the fault condition is no longer detected. The alarm must be acknowledged and reset by manually pressing the appropriate buttons or by activating the LogicsManager output "External acknowledgment" (via a discrete input or via an interface).
16189	Enabled	2	[Always]	Monitoring for this fault condition is continuously enabled.
			87.70 LM:Eng.mon	Monitoring for fault conditions is not performed until engine monitoring is enabled. This is determined through the LogicsManager equation "Release engine monitoring".
			For xx = 1 to 32: 96.{xx} LM: Flag{xx}	The monitoring is executed, if the LogicsManager "Flag {xx}" is TRUE. Example: 96.01 LM: Flag 1, 96.02 LM: Flag 2, ..., 96.32 LM: Flag 32
16206	Monitoring IKD-OUT-16	2	[Off]	Monitoring IKD-OUT-16 is off.
			Channels 1-16	Monitoring IKD-OUT-16 for channels 1-16 is switched on. (If there is a timeout for more than the time configured at 16186

ID	Parameter	CL	Setting range [Default]	Description
				Alarm class), alarm CANopen Interface 2 will trip.
			Channels 1-32	Monitoring IKD-OUT-16 for channels 1-16 and IKD-OUT-16 for channels 17-32 is switched on. (If there is a timeout for more than the time configured at 16186 Alarm class), alarm CANopen Interface 2" will trip.
			Channels 17-32	Monitoring IKD-OUT-16 for channels 17-32 is switched on. (If there is a timeout for more than the time configured at 16186 Alarm class) alarm, CANopen Interface 2 will trip.
				Note: The IKD with 8 channels has 8 input and 8 output channels. The IKD-16 have only input or output channels each. For this reason the IKD-OUT-16 must be monitored separately for timeout.
16207	Monitoring IKD-IN	2	Off	Monitoring IKD-IN is off.
			Channels 1-16	Monitoring IKD-IN for channels 1-16 is switched on. (If there is a timeout for more than the time configured at 16186 Alarm class), alarm CANopen Interface 2 will trip.
			[Channels 1-32]	Monitoring IKD-IN for channels 1-16 and IKD-OUT-16 for channels 17-32 is switched on. (If there is a timeout for more than the time configured at 16186 Alarm class), alarm CANopen Interface 2" will trip.
			Channels 17-32	Monitoring IKD-IN for channels 17-32 is switched on. (If there is a timeout for more than the time configured at 16186 Alarm class) alarm, CANopen Interface 2 will trip.
				Note: If IKDs are configured (with parameter 15320 Select external terminals) it could be the case, that only IKD-OUT-16 and no IKD-IN are available. But the easYgen is expecting messages from IKD-IN too. Therefore, the monitoring can be switched on and off separately.

4.5.6.6 CAN Interface 3

General notes

The CANopen interface 3 is monitored. If the interface does not receive a Receive Process Data Object (RPDO) before the delay expires, an alarm will be initiated.



If this protective function is triggered, the display indicates "CANopen interface 3" and the logical command variable "08.29" will be enabled.

ID	Parameter	CL	Setting range [Default]	Description
3165	Monitoring	2	On	CANopen interface 3 monitoring is carried out according to the following parameters.
			[Off]	Monitoring is disabled.
3169	Delay	2	0.01 to 650.00 s [0.20 s]	The maximum receiving break is configured with this parameter. If the interface does not receive an RPDO within this time, the action specified by the alarm class is initiated. The delay timer is re-initialized after every message is received.
3166	Alarm class	2	Class A, Class B, Class C, Class D, Class E, Class F , Control [Class B]	Each limit may be assigned an independent alarm class that specifies what action should be taken when the limit is surpassed.
			Notes For additional information refer to "9.5.4 Alarm Classes"	
3167	Self acknowledge	2	[Yes]	The control unit automatically clears the alarm if the fault condition is no longer detected.
			No	The control unit does not automatically reset the alarm when the fault condition is no longer detected. The alarm must be acknowledged and reset by manually pressing the appropriate buttons or by activating the LogicsManager output "External acknowledgment" (via a discrete input or via an interface).
3168	Enabled	2	[Always]	Monitoring for this fault condition is continuously enabled.
			87.70 LM:Eng.mon	Monitoring for fault conditions is not performed until engine monitoring is enabled. This is determined through the LogicsManager equation "Release engine monitoring".
			For $xx = 1$ to 32 : 96.{xx} LM: Flag{xx}	The monitoring is executed, if the LogicsManager "Flag {xx}" is TRUE. Example:

ID	Parameter	CL	Setting range [Default]	Description
				96.01 LM: Flag 1, 96.02 LM: Flag 2, ..., 96.32 LM: Flag 32

4.5.6.7 CAN Interface 2 - J1939 Interface

General notes

This monitor function can monitor messages of up to 5 different J1939 devices separately by their source addresses.

If the easYgen doesn't receive any message from the corresponding device within the configured time the command variable "08.10 CAN fault J1939" becomes active. Additionally a specific alarm "08.37 J1939 ECU timeout", "08.38 J1939 dev. 1 timeout", "08.39 J1939 dev. 2 timeout", "08.40 J1939 dev. 3 timeout or "08.77 J1939 AVR timeout will be triggered.

ECU settings

ID	Parameter	CL	Setting range [Default]	Description
15172	Monitoring	2	On	Monitoring of the ECU's CAN messages is carried out according to the following parameters. The address of the ECU is taken from parameter "Engine control address" (↪ 15107)
			[Off]	Monitoring is disabled.
15176	Delay	2	0.02 to 999.00 s [1.00 s]	The delay is configured with this parameter. If the interface does not receive a CAN message from the ECU within this delay time, the action specified by the alarm class is initiated. The delay timer is re-initialized if any message from the ECU is received.
15173	Alarm class	2	Class A, Class B, Class C, Class D, Class E, Class F, Control [Class B]	Each limit may be assigned to an independent alarm class that specifies what action should be taken when the limit is surpassed.
				Notes For additional information refer to ↪ "9.5.4 Alarm Classes"
15174	Self acknowledge	2	[Yes]	The control unit automatically clears the alarm if the fault condition is no longer detected.
			No	The control unit does not automatically reset the alarm when the fault condition is no longer detected.

ID	Parameter	CL	Setting range [Default]	Description
				The alarm must be acknowledged and reset by manually pressing the appropriate buttons or by activating the LogicsManager output "External acknowledgment" (via a discrete input or via an interface).
15175	Enabled	2	[Always]	Monitoring for this fault condition is continuously enabled.
			87.70 LM:Eng.mon	Monitoring for fault conditions is not performed until engine monitoring is enabled. This is determined through the LogicsManager equation "Release engine monitoring".
			For xx = 1 to 32: 96.{xx} LM: Flag{xx}	The monitoring is executed, if the LogicsManager "Flag {xx}" is TRUE. Example: 96.01 LM: Flag 1, 96.02 LM: Flag 2, ..., 96.32 LM: Flag 32

Table 84: J1939 Monitoring

Device 1 settings

ID	Parameter	CL	Setting range [Default]	Description
15177	Monitoring	2	On	Monitoring of the CAN messages of device 1 is carried out according to the following parameters.
			[Off]	Monitoring is disabled.
15178	Address	2	0 to 255 [1]	This device address is monitored.
15182	Delay	2	0.02 to 999.00 s [1.00 s]	The delay is configured with this parameter. If the interface does not receive a CAN message from device 1 within this delay time, the action specified by the alarm class is initiated. The delay timer is re-initialized if any message from the device 1 is received.
15179	Alarm class	2	Class A, Class B, Class C, Class D, Class E, Class F , Control [Class B]	Each limit may be assigned to an independent alarm class that specifies what action should be taken when the limit is surpassed. Notes For additional information refer to 9.5.4 Alarm Classes

ID	Parameter	CL	Setting range [Default]	Description
15180	Self acknowledge	2	[Yes]	The control unit automatically clears the alarm if the fault condition is no longer detected.
			No	The control unit does not automatically reset the alarm when the fault condition is no longer detected. The alarm must be acknowledged and reset by manually pressing the appropriate buttons or by activating the LogicsManager output "External acknowledgment" (via a discrete input or via an interface).
15181	Enabled	2	[Always]	Monitoring for this fault condition is continuously enabled.
			87.70 LM:Eng.mon	Monitoring for fault conditions is not performed until engine monitoring is enabled. This is determined through the LogicsManager equation "Release engine monitoring".
			For xx = 1 to 32: 96.{xx} LM: Flag{xx}	The monitoring is executed, if the LogicsManager "Flag {xx}" is TRUE. Example: 96.01 LM: Flag 1, 96.02 LM: Flag 2, ..., 96.32 LM: Flag 32

Table 85: J1939 Monitoring: Device 1

Device 2 settings

ID	Parameter	CL	Setting range [Default]	Description
15183	Monitoring	2	On	Monitoring of the CAN messages of device 2 is carried out according to the following parameters.
			[Off]	Monitoring is disabled.
15184	Address	2	0-255 [1]	This device address is monitored.
15188	Delay	2	0.02 to 999.00 s [1.00 s]	The delay is configured with this parameter. If the interface does not receive a CAN message from device 2 within this delay time, the action specified by the alarm class is initiated. The delay timer is re-initialized if any message from the device 2 is received.

ID	Parameter	CL	Setting range [Default]	Description
15185	Alarm class	2	Class A, Class B, Class C, Class D, Class E, Class F , Control [Class B]	Each limit may be assigned to an independent alarm class that specifies what action should be taken when the limit is surpassed.
			Notes For additional information refer to "9.5.4 Alarm Classes"	
15186	Self acknowledge	2	[Yes]	The control unit automatically clears the alarm if the fault condition is no longer detected.
			No	The control unit does not automatically reset the alarm when the fault condition is no longer detected. The alarm must be acknowledged and reset by manually pressing the appropriate buttons or by activating the LogicsManager output "External acknowledgment" (via a discrete input or via an interface).
15187	Enabled	2	[Always]	Monitoring for this fault condition is continuously enabled.
			87.70 LM:Eng.mon	Monitoring for fault conditions is not performed until engine monitoring is enabled. This is determined through the LogicsManager equation "Release engine monitoring".
			For $xx = 1$ to 32 : 96.{xx} LM: Flag{xx}	The monitoring is executed, if the LogicsManager "Flag {xx}" is TRUE. Example: 96.01 LM: Flag 1, 96.02 LM: Flag 2, ..., 96.32 LM: Flag 32

Table 86: J1939 Monitoring: Device 2

Device 3 settings

ID	Parameter	CL	Setting range [Default]	Description
15189	Monitoring	2	On	Monitoring of the CAN messages of device 3 is carried out according to the following parameters.
			[Off]	Monitoring is disabled.
15190	Address	2	0 to 255 [1]	This device address is monitored.

ID	Parameter	CL	Setting range [Default]	Description
15194	Delay	2	0.02 to 999.00 s [1.00 s]	<p>The delay is configured with this parameter. If the interface does not receive a CAN message from device 3 within this delay time, the action specified by the alarm class is initiated.</p> <p>The delay timer is re-initialized if any message from the device 3 is received.</p>
15191	Alarm class	2	Class A, Class B, Class C, Class D, Class E, Class F , Control [Class B]	<p>Each limit may be assigned to an independent alarm class that specifies what action should be taken when the limit is surpassed.</p> <p>Notes</p> <p>For additional information refer to "9.5.4 Alarm Classes"</p>
15192	Self acknowledge	2	[Yes]	The control unit automatically clears the alarm if the fault condition is no longer detected.
			No	<p>The control unit does not automatically reset the alarm when the fault condition is no longer detected.</p> <p>The alarm must be acknowledged and reset by manually pressing the appropriate buttons or by activating the LogicsManager output "External acknowledgment" (via a discrete input or via an interface).</p>
15193	Enabled	2	[Always]	Monitoring for this fault condition is continuously enabled.
			87.70 LM:Eng.mon	Monitoring for fault conditions is not performed until engine monitoring is enabled. This is determined through the LogicsManager equation "Release engine monitoring".
			<p>For xx = 1 to 32:</p> <p>96.{xx}</p> <p>LM: Flag{xx}</p>	<p>The monitoring is executed, if the LogicsManager "Flag {xx}" is TRUE.</p> <p>Example:</p> <p>96.01 LM: Flag 1, 96.02 LM: Flag 2, ..., 96.32 LM: Flag 32</p>

Table 87: J1939 Monitoring: Device 3

Device AVR settings

ID	Parameter	CL	Setting range [Default]	Description
14792	Monitoring	2	On	Monitoring of the CAN messages of AVR is carried out according to the following parameters.
			[Off]	Monitoring is disabled.
14797	Address	2	0 to 255 [144]	This device address is monitored.
14796	Delay	2	0.02 to 999.00 s [1.00 s]	<p>The delay is configured with this parameter. If the interface does not receive a CAN message from AVR within this delay time, the action specified by the alarm class is initiated.</p> <p>The delay timer is re-initialized if any message from the device 3 is received.</p>
14793	Alarm class	2	Class A, Class B, Class C, Class D, Class E, Class F , Control [Class B]	Each limit may be assigned to an independent alarm class that specifies what action should be taken when the limit is surpassed.
				<p>Notes</p> <p>For additional information refer to 9.5.4 Alarm Classes</p>
14794	Self acknowledge	2	[Yes]	The control unit automatically clears the alarm if the fault condition is no longer detected.
			No	<p>The control unit does not automatically reset the alarm when the fault condition is no longer detected.</p> <p>The alarm must be acknowledged and reset by manually pressing the appropriate buttons or by activating the LogicsManager output "External acknowledgment" (via a discrete input or via an interface).</p>
14795	Enabled	2	[Always]	Monitoring for this fault condition is continuously enabled.
			87.70 LM:Eng.mon	Monitoring for fault conditions is not performed until engine monitoring is enabled. This is determined through the LogicsManager equation "Release engine monitoring".
			<p>For xx = 1 to 32:</p> <p>96.{xx}</p> <p>LM: Flag{xx}</p>	<p>The monitoring is executed, if the LogicsManager "Flag {xx}" is TRUE.</p> <p>Example:</p>

ID	Parameter	CL	Setting range [Default]	Description
				96.01 LM: Flag 1, 96.02 LM: Flag 2, ..., 96.32 LM: Flag 32

Table 88: J1939 Monitoring: AVR (only if Exciter-10-P2 is configured)

4.5.6.8 J1939 Interface - Red (Stop) Alarm

General notes

This monitor monitors, whether a specific alarm bit is received from the CAN J1939 interface. This enables to configure the easYgen in a way that a reaction is caused by this bit (e.g. warning, shutdown).



If this protective function is triggered, the display indicates "Red stop lamp" and the logical command variable "05.13" will be enabled.

ID	Parameter	CL	Setting range [Default]	Description
15115	Monitoring	2	On	Monitoring of the Red Stop Lamp message from the ECU is carried out according to the following parameters.
			[Off]	Monitoring is disabled.
15119	Delay	2	0 to 999 s [2 s]	The red stop lamp delay is configured with this parameter. If the ECU sends the Red Stop Lamp On message, the action specified by the alarm class is initiated after the delay configured here expires.
15116	Alarm class	2	Class A, Class B, Class C, Class D, Class E, Class F, Control [Class A]	Each limit may be assigned an independent alarm class that specifies what action should be taken when the limit is surpassed.
				Notes For additional information refer to "9.5.4 Alarm Classes"
15117	Self acknowledge	2	[Yes]	The control unit automatically clears the alarm if the fault condition is no longer detected.
			No	The control unit does not automatically reset the alarm when the fault condition is no longer detected. The alarm must be acknowledged and reset by manually pressing the appropriate buttons or by activating the LogicsManager output "External"

ID	Parameter	CL	Setting range [Default]	Description
				acknowledgment" (via a discrete input or via an interface).
15118	Enabled	2	[Always]	Monitoring for this fault condition is continuously enabled.
			87.70 LM:Eng.mon	Monitoring for fault conditions is not performed until engine monitoring is enabled. This is determined through the LogicsManager equation "Release engine monitoring".
			For xx = 1 to 32: 96.{xx} LM: Flag{xx}	The monitoring is executed, if the LogicsManager "Flag {xx}" is TRUE. Example: 96.01 LM: Flag 1, 96.02 LM: Flag 2, ..., 96.32 LM: Flag 32

4.5.6.9 J1939 Interface - Amber Warning Alarm

General notes

This monitor monitors, whether a specific alarm bit is received from the CAN J1939 interface. This enables to configure the easYgen in a way that a reaction is caused by this bit (e.g. warning, shutdown).



If this protective function is triggered, the display indicates "Amber warning lamp" and the logical command variable "05.14" will be enabled.

ID	Parameter	CL	Setting range [Default]	Description
15120	Monitoring	2	On	Monitoring of the Amber Warning Lamp message from the ECU is carried out according to the following parameters.
			[Off]	Monitoring is disabled.
15124	Delay	2	0 to 999 s [2 s]	The amber warning lamp delay is configured with this parameter. If the ECU sends the Amber Warning Lamp On message, the action specified by the alarm class is initiated after the delay configured here expires.
15121	Alarm class	2	Class A, Class B, Class C, Class D, Class E, Class F , Control [Class A]	Each limit may be assigned an independent alarm class that specifies what action should be taken when the limit is surpassed.
				Notes

ID	Parameter	CL	Setting range [Default]	Description
				For additional information refer to 9.5.4 Alarm Classes
15122	Self acknowledge	2	[Yes]	The control unit automatically clears the alarm if the fault condition is no longer detected.
			No	The control unit does not automatically reset the alarm when the fault condition is no longer detected. The alarm must be acknowledged and reset by manually pressing the appropriate buttons or by activating the LogicsManager output "External acknowledgment" (via a discrete input or via an interface).
15123	Enabled	2	[Always]	Monitoring for this fault condition is continuously enabled.
			87.70 LM:Eng.mon	Monitoring for fault conditions is not performed until engine monitoring is enabled. This is determined through the LogicsManager equation "Release engine monitoring".
			For $xx = 1$ to 32 : 96.{xx} LM: Flag{xx}	The monitoring is executed, if the LogicsManager "Flag {xx}" is TRUE. Example: 96.01 LM: Flag 1, 96.02 LM: Flag 2, ..., 96.32 LM: Flag 32

4.5.6.10 J1939 Interface - Protect Alarm

General notes

This monitor monitors, whether a specific alarm bit is received from the CAN J1939 interface. This enables to configure the easYgen in a way that a reaction is caused by this bit (e.g. warning, shutdown).



If this protective function is triggered, the display indicates "Protection lamp DM1" and the logical command variable "03.44" will be enabled.

ID	Parameter	CL	Setting range [Default]	Description
1914	Monitoring	2	On	Monitoring of the protection Lamp message from the ECU is carried out according to the following parameters.
			[Off]	Monitoring is disabled.

ID	Parameter	CL	Setting range [Default]	Description
1915	Delay	2	0 to 999 s [2 s]	The protection lamp delay is configured with this parameter. If the ECU sends the Protection Lamp On message, the action specified by the alarm class is initiated after the delay configured here expires.
1916	Alarm class	2	Class A, Class B, Class C, Class D, Class E, Class F , Control [Class A]	An alarm can be assigned, that specifies what action should be taken when the conditions are fulfilled.
				Notes For additional information refer to "9.5.4 Alarm Classes"
1917	Self acknowledge	2	[Yes]	The control unit automatically clears the alarm if the fault condition is no longer detected.
			No	The control unit does not automatically reset the alarm when the fault condition is no longer detected. The alarm must be acknowledged and reset by manually pressing the appropriate buttons or by activating the LogicsManager output "External acknowledgment" (via a discrete input or via an interface).
1918	Enabled	2	[Always]	Monitoring for this fault condition is continuously enabled.
			87.70 LM:Eng.mon	Monitoring for fault conditions is not performed until engine monitoring is enabled. This is determined through the LogicsManager equation "Release engine monitoring".
			For xx = 1 to 32: 96.{xx} LM: Flag{xx}	The monitoring is executed, if the LogicsManager "Flag {xx}" is TRUE. Example: 96.01 LM: Flag 1, 96.02 LM: Flag 2, ..., 96.32 LM: Flag 32

4.5.6.11 J1939 Interface - Emission/Malfunction Alarm

General notes

This monitor monitors, whether a specific alarm bit is received from the CAN J1939 interface. This enables to configure the easYgen in a way that a reaction is caused by this bit (e.g. warning, shutdown).



If this protective function is triggered, the display indicates "Emission lamp DM1" and the logical command variable "03.45" will be enabled.

ID	Parameter	CL	Setting range [Default]	Description
1919	Monitoring	2	On	Monitoring of the Emission Warning Lamp message from the ECU is carried out according to the following parameters.
			[Off]	Monitoring is disabled.
1920	Delay	2	0 to 999 s [2 s]	The Emission warning lamp delay is configured with this parameter. If the ECU sends the Emission Warning Lamp On message, the action specified by the alarm class is initiated after the delay configured here expires.
1921	Alarm class	2	Class A, Class B, Class C, Class D, Class E, Class F , Control [Class A]	An alarm can be assigned, that specifies what action should be taken when the conditions are fulfilled.
				Notes For additional information refer to ↩> "9.5.4 Alarm Classes"
1922	Self acknowledge	2	[Yes]	The control unit automatically clears the alarm if the fault condition is no longer detected.
			No	The control unit does not automatically reset the alarm when the fault condition is no longer detected. The alarm must be acknowledged and reset by manually pressing the appropriate buttons or by activating the LogicsManager output "External acknowledgment" (via a discrete input or via an interface).
1923	Enabled	2	[Always]	Monitoring for this fault condition is continuously enabled.
			87.70 LM:Eng.mon	Monitoring for fault conditions is not performed until engine monitoring is enabled. This is determined through the LogicsManager equation "Release engine monitoring".
			For xx = 1 to 32: 96.{xx} LM: Flag{xx}	The monitoring is executed, if the LogicsManager "Flag {xx}" is TRUE. Example:

ID	Parameter	CL	Setting range [Default]	Description
				96.01 LM: Flag 1, 96.02 LM: Flag 2, ..., 96.32 LM: Flag 32

4.5.6.12 J1939 Interface - DM1 Alarms

This monitor is a switch to transfer the content of the DM1 alarm message onto the alarm screen of the easYgen. The event log is as well considered.

ID	Parameter	CL	Setting range [Default]	Description
15156	Monitoring	2		Most of the J1939 devices release a standardized DM1 message as an error message on the CAN bus. These messages can be entered into the alarm list of the easYgen. The alarm class is fixed to alarm class A. A J1939 device CAN monitor the states of his inputs. When a error occurs a DM1 message is released.
			[On]	DM1 messages will be recorded in the alarm list.
			Off	DM1 messages will be not recorded in the alarm list.
				Notes Only known SPNs can be recorded in the alarm list. These are J1939 Standard SPNs which also can be visualized. Manufacturer specific SPNs will be ignored.
9947	Self acknowledge	2	[Yes]	The control unit automatically clears the alarm if the fault condition is no longer detected.
			No	The control unit does not automatically reset the alarm when the fault condition is no longer detected. The alarm must be acknowledged and reset by manually pressing the appropriate buttons or by activating the LogicsManager output "External acknowledgment" (via a discrete input or via an interface).

4.5.6.13 Ethernet interfaces

General notes

The devices reacts on an abnormal rate of Ethernet UDP-messages per time scale e.g. "broadcast storm". If a maximal allowed number of messages is received, the device closes all Ethernet ports to give the own device more calculation time. After about 100ms the Ethernet ports are opened again to recheck the UDP message traffic. As long the traffic is still high the device remains in this protection state.



If this protective function is triggered, after the configured delay time the display indicates the alarm "Ethernet issue" and the logical command variable "08.62 Ethernet issue" will be enabled.

ID	Parameter	CL	Setting range [Default]	Description
3174	Monitoring	2	[On]	Ethernet UDP message monitoring is enabled.
			Off	Monitoring is disabled.
3175	Delay	2	0.02 to 99.00 s [2.00 s]	If the issue contiunoes for the time configured here, an alarm will be issued.
3176	Alarm class	2	Class A, Class B, Class C, Class D, Class E, Class F , Control [Class B]	Each limit may be assigned an independent alarm class that specifies what action should be taken when the limit is surpassed.
				Notes For additional information refer to "9.5.4 Alarm Classes"
3177	Self acknowledge	2	[Yes]	The control unit automatically clears the alarm if the fault condition is no longer detected.
			No	The control unit does not automatically reset the alarm when the fault condition is no longer detected. The alarm must be acknowledged and reset by manually pressing the appropriate buttons or by activating the LogicsManager output "External acknowledgment" (via a discrete input or via an interface).
3178	Enabled	2	[Always]	Monitoring for this fault condition is continuously enabled.
			87.70 LM:Eng.mon	Monitoring for fault conditions is not performed until engine monitoring is enabled. This is determined through the LogicsManager equation "Release engine monitoring".
			For xx = 1 to 32: 96.{xx}	The monitoring is executed, if the LogicsManager "Flag {xx}" is TRUE.

ID	Parameter	CL	Setting range [Default]	Description
			LM: Flag{xx}	Example: 96.01 LM: Flag 1, 96.02 LM: Flag 2, ..., 96.32 LM: Flag 32

4.5.6.14 Battery Overvoltage (Level 1 & 2)

General notes

There are two battery overvoltage alarm levels available in the control. Both alarms are definite time alarms and. Monitoring of the voltage is done in two steps.



If this protective function is triggered, the display indicates "Bat. overvoltage 1" or "Bat. overvoltage 2" and the logical command variable "08.01" or "08.02" will be enabled.

Refer to [9.1.1 Triggering Characteristics](#) for the triggering characteristic of this monitoring function.

ID	Parameter	CL	Setting range [Default]	Description
3450 3456	Monitoring	2	3450: [On] 3456: [Off] (Hysteresis: 0.1 V) (Reset Delay: 1s)	Overvoltage monitoring of the battery voltage is carried out according to the following parameters. Both values may be configured independent from each other (prerequisite: Level 1 > Level 2). Monitoring is disabled for Level 1 limit and/or Level 2 limit.
3454 3460	Limit	2	8.0 to 42.0 V 3454: [32.0 V] 3460: [35.0 V]	The threshold values that are to be monitored are defined here. If the monitored battery voltage reaches or exceeds this value for at least the delay time without interruption, the action specified by the alarm class is initiated.
3455 3461	Delay	2	0.02 to 99.99 s 3455: [5.00 s] 3461: [1.00 s]	If the monitored battery voltage exceeds the threshold value for the delay time configured here, an alarm will be issued. Notes If the monitored battery voltage falls below the threshold (minus the hysteresis) before the delay expires the time will be reset.
3451 3457	Alarm class	2	Class A, Class B, Class C, Class D, Class E, Class F, Control [Class B]	Each limit may be assigned an independent alarm class that specifies what action should be taken when the limit is surpassed.

ID	Parameter	CL	Setting range [Default]	Description
				Notes For additional information refer to ↗ "9.5.4 Alarm Classes"
3452 3458	Self acknowledge	2	Yes	The control unit automatically clears the alarm if the fault condition is no longer detected.
		4	[No]	The control unit does not automatically reset the alarm when the fault condition is no longer detected. The alarm must be acknowledged and reset by manually pressing the appropriate buttons or by activating the LogicsManager output "External acknowledgment" (via a discrete input or via an interface).
3453 3459	Enabled	2	[Always]	Monitoring for this fault condition is continuously enabled.
		4	87.70 LM:Eng.mon	Monitoring for fault conditions is not performed until engine monitoring is enabled. This is determined through the LogicsManager equation "Release engine monitoring".
			For $xx = 1$ to 32 : 96.{xx} LM: Flag{xx}	The monitoring is executed, if the LogicsManager "Flag {xx}" is TRUE. Example: 96.01 LM: Flag 1, 96.02 LM: Flag 2, ..., 96.32 LM: Flag 32

4.5.6.15 Battery Undervoltage (Level 1 & 2)

General notes

There are two battery undervoltage alarm levels available in the control. Both alarms are definite time alarms. Monitoring of the voltage is done in two steps.



If this protective function is triggered, the display indicates "Bat. undervoltage 1" or "Bat. undervoltage 2" and the logical command variable "08.03" or "08.04" will be enabled.

Refer to [↗ "9.1.1 Triggering Characteristics"](#) for the triggering characteristic of this monitoring function.

ID	Parameter	CL	Setting range [Default]	Description
3500	Monitoring	2	[On]	Undervoltage monitoring of the battery voltage is carried out

4 Configuration

4.5.6.15 Battery Undervoltage (Level 1 & 2)

ID	Parameter	CL	Setting range [Default]	Description
3506				according to the following parameters. Both values may be configured independent from each other (prerequisite: Level 1 > Level 2).
			Off	Monitoring is disabled for Level 1 limit and/or Level 2 limit.
3504 3510	Limit	2	8.0 to 42.0 V 3504: [24.0 V] 3510: [20.0 V] (Hysteresis: 0.1 V) (Reset Delay: 1s)	<p>The threshold values that are to be monitored are defined here.</p> <p>If the monitored battery voltage reaches or falls below this value for at least the delay time without interruption, the action specified by the alarm class is initiated.</p> <p>Notes</p> <p>The default monitoring limit for battery undervoltage is 24 Vdc after 60 seconds.</p> <p>This is because in normal operation the terminal voltage is approximately 26 Vdc (alternator charged battery).</p>
3505 3511	Delay	2	0.02 to 99.99 s 3505: [60.00 s] 3511: [10.00 s]	<p>If the battery voltage falls below the threshold value for the delay time configured here, an alarm will be issued.</p> <p>Notes</p> <p>If the battery voltage exceeds the threshold (plus the hysteresis) again before the delay expires the time will be reset.</p>
3501 3507	Alarm class	2	Class A, Class B, Class C, Class D, Class E, Class F , Control [Class B]	<p>Each limit may be assigned an independent alarm class that specifies what action should be taken when the limit is surpassed.</p> <p>Notes</p> <p>For additional information refer to 9.5.4 Alarm Classes</p>
3502 3508	Self acknowledge	2 4	Yes [No]	<p>The control unit automatically clears the alarm if the fault condition is no longer detected.</p> <p>The control unit does not automatically reset the alarm when the fault condition is no longer detected.</p> <p>The alarm must be acknowledged and reset by manually pressing the appropriate buttons or by activating the LogicsManager output "External acknowledgment" (via a discrete input or via an interface).</p>

ID	Parameter	CL	Setting range [Default]	Description
3503	Enabled	2	[Always]	Monitoring for this fault condition is continuously enabled.
3509		4	87.70 LM:Eng.mon	Monitoring for fault conditions is not performed until engine monitoring is enabled. This is determined through the LogicsManager equation "Release engine monitoring".
			For xx = 1 to 32: 96.{xx} LM: Flag{xx}	The monitoring is executed, if the LogicsManager "Flag {xx}" is TRUE. Example: 96.01 LM: Flag 1, 96.02 LM: Flag 2, ..., 96.32 LM: Flag 32

4.5.6.16 Monitoring PV load reference

General notes

The PV load reference function contains a monitor for generator reverse power. It is enabled if parameter [8911](#) is configured to "Regulated". The monitor observes the system generator load and trips the alarm "08.71 PV disconnect" if the real generator load underruns the configured disconnect level e.g. in case of reverse power. Then the PV power can be cut. This can be maintained if the LogicsManager "08.71 PV disconnect" is assigned to a relay output.

Parameter

Navigate to [Parameter / Configuration / Configure monitoring / Miscellaneous / Other monitoring / PV load reference].

ID	Parameter	CL	Setting range [Default]	Description
8923	PV disconnect level	2	-20.0 to 20.0% [-2.0%]	This is the system generator load level on which the PV is immediately to cut. (Hysteresis is 0.5%.)
8924	Delay	2	0.1 to 99.0 s [5.0 s]	If the system generator load level underruns the disconnect level for the delay time the alarm is tripped. (The delay off time is 0.08s.)
8925	Alarm class	2	Class A, Class B, Class C, Class D, Class E, Class F , Control [Class B]	Each limit may be assigned an independent alarm class that specifies what action should be taken when the limit is surpassed.
				Notes For additional information refer to 9.5.4 Alarm Classes

ID	Parameter	CL	Setting range [Default]	Description
8926	Self acknowledge	2	Yes	The control unit automatically clears the alarm if the fault condition is no longer detected.
			[No]	The control unit does not automatically reset the alarm when the fault condition is no longer detected. The alarm must be acknowledged and reset by manually pressing the appropriate buttons or by activating the LogicsManager output "External acknowledgment" (via a discrete input or via an interface).

4.5.6.17 Multi-Unit Parameter Alignment

General notes

The multi-unit parameter alignment functionality requires that the relevant parameters are all configured identically at all participating units. In GCB/GC mode **A13** the parameter alignment is performed in the Group Controller.



If at least one of these parameters is configured different in at least one of the units, the display indicates "Parameter alignment" on all units and the logical command variable "08.16" will be enabled. To identify different configured units, please use the diagnostic screen "Genset parameter alignment":

HMI: [Next Page / Multi-unit / Genset parameter alignment]

ToolKit: [STATUS MENU / Multi-unit / Genset parameter alignment]

This alarm is always self-acknowledging, i.e. the control automatically clears the alarm if it is no longer valid.

The setting of the following parameters will be monitored:

Parameter	ID
Start stop mode	↳ 5752
Dead busbar start mode	↳ 5753
Fit size of engine	↳ 5754
Fit service hours	↳ 5755
Changes of engines	↳ 5756
IOP Reserve power or IOP Reserve power 2 if enabled 3	↳ 5760 or ↳ 5648
IOP Hysteresis	↳ 5761
IOP Max. generator load	↳ 5762
IOP Min. generator load	↳ 5763
IOP Dynamic	↳ 5757

Parameter	ID
IOP Add on delay	↪ 5764
IOP Add on delay at rated load	↪ 5765
IOP Add off delay	↪ 5766
MOP Minimum load	↪ 5767
MOP Reserve power or MOP Reserve power 2 if enabled	↪ 5768 or ↪ 5649
MOP Hysteresis	↪ 5769
MOP Max. generator load	↪ 5770
MOP Min. generator load	↪ 5771
MOP Dynamic	↪ 5758
MOP Add on delay	↪ 5772
MOP Add on delay at rated load	↪ 5773
MOP Add off delay	↪ 5774
LDSS sort priority always	↪ 5777
Transfer rate LS fast message	↪ 9921

Table 89: Multi-unit parameter alignment - monitored parameters

ID	Parameter	CL	Setting range [Default]	Description
4070	Monitoring	2	[On]	Multi-unit parameter alignment monitoring is carried out.
			Off	Monitoring is disabled.
4071	Alarm class	2	Alarm class Class A, Class B, Class C, Class D, Class E, Class F , Control [Class B]	This function may be assigned an independent alarm class that specifies what action should be taken when this function triggers an alarm.
				Notes For additional information refer to ↪ "9.5.4 Alarm Classes".
4076	Delay	2	Yes	The control automatically clears the alarm if the fault condition is no longer detected.
			[No]	The control does not automatically reset the alarm when the fault condition is no longer detected. The alarm must be acknowledged and reset by manually pressing the appropriate buttons or by activating the LogicsManager output "External acknowledgment" (via a discrete input or via an interface).
4078	Enabled	2	[Always]	Monitoring for this fault condition is continuously enabled.

ID	Parameter	CL	Setting range [Default]	Description
			87.70 LM:Eng.mon	Monitoring for fault conditions is not performed until engine monitoring is enabled. This is determined through the LogicsManager equation "Release engine monitoring". For xx = 1 to 32: 96.{xx}, LM: Flag{xx} The monitoring is executed, if the LogicsManager "Flag {xx}" is TRUE. Example: 96.01 LM: Flag 1, 96.02 LM: Flag 2, ..., 96.32 LM: Flag 32
4077	Self acknowledge	2	0.02 to 999.99 s 3.00 s	Parameter alignment monitoring delay If a parameter alignment error occurs, the alarm will be delayed by a basic delay time (depending on the communication method) plus the delay time defined here.

4.5.6.18 Multi-Unit Missing easYgen

General notes

The multi-unit missing easYgen monitoring function checks whether all participating units are available and have valid data (all taught-in members have valid data on the load share line).

If the number of available units is less than the number of displayed "Monitored easYgen" [↪ 9925](#) (initiated by parameter [↪ 13356](#) System update) for at least the delay time^{1.)}, the display indicates "Missing easYgen" and the logical command variables "08.17" and "08.27" will be enabled.

1.) In case of load sharing with Ethernet UDP messages: The delay time of missing member depends on the valid data and will be determined through the 7489 "Timeout cycles" and the 7497 "Timeout cycles data". Refer to parameter [↪ 7497](#) for better understanding.



After energizing the easYgen, a delay is started, which allows a possible "Missing easYgen" alarm to become active.

When using **only CAN**, the delay for the first 140 seconds after booting depends on the Device Number (parameter [↔ 1702](#)): Delay = (Device number + 11) seconds

This delay serves for detecting the Master of the CAN bus connection. Approximately two minutes after energizing the easYgen, the alarm delay will be set to a fix time, which depends on the setting of parameter [↔ 9921](#) (Transfer rate LS fast message) and is in the range between 3 to 12 seconds.

If load share is with **any Ethernet**, after energizing the easYgen the delay is 12 s.

After 12 seconds the delay time is approximately 1 s.

During »System update« the alarm is disabled.

For more information see [↔ "6.2.2 Communication Management"](#)



If the easYgen is configured to the application modes **A07** to **A13**, the monitoring function also checks the participating LSx units.

ID	Parameter	CL	Setting range [Default]	Description
4060	Monitoring	2	On	Multi-unit missing members monitoring is carried out.
			[Off]	Monitoring is disabled.
4061	Alarm class	2	Class A, Class B, Class C, Class D, Class E, Class F , Control [Class B]	This function may be assigned an independent alarm class that specifies what action should be taken when this function triggers an alarm.
				Notes For additional information refer to ↔ "9.5.4 Alarm Classes" .
4062	Self acknowledge	2	Yes	The control automatically clears the alarm if the fault condition is no longer detected.
			[No]	The control does not automatically reset the alarm when the fault condition is no longer detected. The alarm must be acknowledged and reset by manually pressing the appropriate buttons or by activating the LogicsManager output "External acknowledgment" (via a discrete input or via an interface).

4.5.6.19 Multi-Unit Missing LSx

General notes

i

If the easYgen is configured to the application modes **A07** to **A13**, the monitoring function also checks the participating LS-x units.

The multi-unit missing LS-x monitoring function works as described above for "Missing easYgen".

If the number of available units is less than the number of displayed "Monitored LSx" [↪ 9926](#) (initiated by parameter [↪ 13356](#) System update) for at least the delay time^{1.)}, the display indicates "Missing LSx" and the logical command variables "08.17" and "08.28" will be enabled.

1.) In case of load sharing with Ethernet UDP messages: The delay time of missing member depends on the valid data and will be determined through the 7489 "Timeout cycles" and the 7497 "Timeout cycles data". Refer to parameter [↪ 7497](#) for better understanding.

i

After energizing the easYgen, a delay is started, which allows a possible "Missing easYgen" alarm to become active.

When using **only CAN**, the delay for the first 140 seconds after booting depends on the Device Number (parameter [↪ 1702](#)): Delay = (Device number + 11) seconds

This delay serves for detecting the Master of the CAN bus connection. Approximately two minutes after energizing the easYgen, the alarm delay will be set to a fix time, which depends on the setting of parameter [↪ 9921](#) (Transfer rate LS fast message) and is in the range between 3 to 12 seconds.

If load share is with **any Ethernet**, after energizing the easYgen the delay is 12 s.

After 12 seconds the delay time is approximately 1 s.

During »System update« the alarm is disabled.

For more information see [↪ "6.2.2 Communication Management"](#)

ID	Parameter	CL	Setting range [Default]	Description
4066	Monitoring	2	On	Multi-unit missing members monitoring is carried out.
			[Off]	Monitoring is disabled.
4067	Alarm class	2	Class A, Class B, Class C, Class D, Class E, Class F , Control [Class B]	This function may be assigned an independent alarm class that specifies what action should be taken when this function triggers an alarm.
				Notes For additional information refer to ↪ "9.5.4 Alarm Classes" .

ID	Parameter	CL	Setting range [Default]	Description
4068	Self acknowledge	2	Yes	The control automatically clears the alarm if the fault condition is no longer detected.
			[No]	The control does not automatically reset the alarm when the fault condition is no longer detected. The alarm must be acknowledged and reset by manually pressing the appropriate buttons or by activating the LogicsManager output "External acknowledgment" (via a discrete input or via an interface).

4.5.6.20 Multi-Unit System Update

General notes

The multi-unit system update monitoring function checks whether only the participating units are available (sending data on the load share line).

If the number of available easYgen units is more than the number of displayed "Monitored easYgen" [↪ 9925](#) (initiated by parameter [↪ 13356](#) System update), the display indicates "System Update easYgen" and the logical command variables "08.43" and "08.65" will be enabled.

If the easYgen is configured to the application modes **A07** to **A15** and the number of available LS-x units is more than the number of displayed "Monitored LS-x" [↪ 9926](#) (initiated by parameter [↪ 13356](#) System update), the display indicates "System Update LS-x" and the logical command variables "08.44" and "08.65" will be enabled.

For more information see [↪ "6.2.2 Communication Management"](#)

ID	Parameter	CL	Setting range [Default]	Description
7832	Monitoring	2	[On]	Enabling to monitor the system if there are more devices against latest updated system configuration.
				Notes To detect less easYgen devices against latest updated system configuration use missing member monitor ↪ 4060 . To detect less LS-5 devices against latest updated system configuration use missing member monitor ↪ 4066 .
			Off	Monitoring is disabled.
7833	Alarm class	2	Class A, Class B, Class C, Class D, Class E, Class F , Control [Class B]	Each limit may be assigned an independent alarm class that specifies what action should be taken when the limit is surpassed.

ID	Parameter	CL	Setting range [Default]	Description
				Notes For additional information refer to ↩️ "9.5.4 Alarm Classes"
7834	Self acknowledge	-/-	Yes	The control unit automatically clears the alarm if the fault condition is no longer detected.
			[No]	The control unit does not automatically reset the alarm when the fault condition is no longer detected. The alarm must be acknowledged and reset by manually pressing the appropriate buttons or by activating the LogicsManager output "External acknowledgment" (via a discrete input or via an interface).

Table 90: Parameter setting: Monitoring system update

4.5.6.21 Operating Range Failure





General notes

The operating range failure monitoring issues an Operating Range Failure Alarm "Oper.range failed XX" (where XX is the number of Check 01 to 12) if one of the following conditions is fulfilled. Example: Check 4 **failed** causes »Oper.range failed 4«.

 Only the first incoming operation range failure will tripp an alarm. Because in most cases this will be the root cause for eventually incoming further operating range alarms. Any other operating range alarm can only be tripped if there is no active or latched operating range alarm.

 If there are more than one failures only the first incoming failure will be indicated and is available at protocol 5014.
If there is no alarm this number is 0.

- **Check 1:** The easYgen tries to close the GCB, but the generator is not within its operating range (parameters ↩️ 5800, ↩️ 5801, ↩️ 5802, or ↩️ 5803).
- **Check 2:** The easYgen tries to synchronize the GCB, but the busbar is not within the generator operating range (parameters ↩️ 5800, ↩️ 5801, ↩️ 5802, or ↩️ 5803).
- **Check 3:** The easYgen tries close the GCB in breaker transition mode "Open transition" with GCB and MCB open status. In this condition the busbar is expected as dead, but the busbar voltage is NOT below the dead busbar detection limit (parameter ↩️ 5820).

- **Check 4:** The easYgen wants to close the GCB onto a dead busbar, but the device cannot close the breaker because there is at least one neighbor device recognized with a closed GCB.
- **Check 5:** The easYgen tries to synchronize the GCB, the MCB is closed, but mains and/or busbar are not within its operating range (parameters  5810,  5811,  5812, or  5813).
- **Check 6:** The easYgen wants close the GGB, but the generator minimum power is not reached and 'LM 12936 Bypass min.Pgen.' is FALSE.
- **Check 7:** The easYgen wants close the GGB in the Open Transition Mode, but the generator minimum power is not reached and 'LM 12936 Bypass min.Pgen.' is FALSE.
- **Check 8:** The easYgen wants synchronize the GGB , but the generator minimum power is not reached.
- **Check 9:** (GGB control mode) The MCB or the GGB is closed with min. one neighbor GCB is closed to the busbar. There is a conflict, the external voltage monitoring of the Load Busbar signals a "Dead load busbar", which cannot be the case.
- **Check 10:** The easYgen wants synchronize the GGB, the MCB is closed, but the mains is not in operating range
- **Check 11:** The easYgen checks the plausibility of generator and busbar, if GCB is closed and the engine runs without run-up synchronization, but the operating range of generator OR busbar is not matched.
- **Check 12:** The easYgen checks the phase rotation of generator, busbar, and mains and a synchronisation shall be executed, but the phase rotation of all systems does not match. (Synchronisation is blocked.)



Regarding Check 9 and 10: The GGB application mode GCB/GGB/L-MCB is tapping the Load busbar via the internal mains measurement. Therefore the check 10 is made via the load busbar condition. So the "load busbar" -OK flag is created out of the mains operation ranges.

No alarm will be issued in idle mode. This monitoring function is disabled below firing speed.

NOTICE!



If load-dependent start/stop (refer to  "4.4.5.5 Load Dependent Start/Stop (LDSS)") is enabled, this monitoring function must be configured with a shutdown alarm class C, D, E, or F) or disable load-dependent start/stop if triggered to ensure that the next engine will be started.



If this protective function is triggered, the display indicates "Operat. range failed" / ("Operating Range failed") and the logical command variable "06.31" will be enabled.

ID	Parameter	CL	Setting range [Default]	Description
2660	Monitoring	2	[On]	Monitoring of the operating range is carried out according to the following parameters.
			Off	Monitoring is disabled.
2663	Delay	2	1 to 999 s [30 s]	If one of the above mentioned conditions for an operating range failure is fulfilled, an alarm will be issued. If the respective condition is not fulfilled anymore before the delay time expires, the delay time will be reset.
2661	Alarm class	2	Class A, Class B, Class C, Class D, Class E, Class F , Control [Class B]	Each limit may be assigned an independent alarm class that specifies what action should be taken when the limit is surpassed.
				Notes For additional information refer to "9.5.4 Alarm Classes"
2662	Self acknowledge	2	Yes	The control unit automatically clears the alarm if the fault condition is no longer detected.
			[No]	The control unit does not automatically reset the alarm when the fault condition is no longer detected. The alarm must be acknowledged and reset by manually pressing the appropriate buttons or by activating the LogicsManager output "External acknowledgment" (via a discrete input or via an interface).

Table 91: Operating Range Failure settings

4.5.6.22 Load Share Interface Redundancy is Lost

General

Beside the automatic handling of redundant load share line messages the easYgen can inform the operator if a redundant load share communication line get lost. Preassumption for that is an enabled redundant load share line like CAN/Ethernet A or Ethernet B/C in conjunction with a successful system update procedure.

If the according alarm has occurred the operator usually checks the "Diagnostic devices" screen. Available on device display or over ToolKit. There he will be informed which channel is affected. Refer to system update for more information.

Function

If the parameter "9924 Load share interface" is configured to "Ethernet B/C" or "CAN/Ethernet A" and the system update was executed, the monitoring becomes active.

The devices observes if the both load share messages are correctly received. If a channel fails the alarm "LS interf. redundancy" is triggered.

ID	Parameter	CL	Setting range [Default]	Description
5017	Monitoring	2		The monitoring of the load share communication line redundancy can be enabled here.
			On	On: Monitoring is enabled
			[Off]	Off: Monitoring is disabled
5018	Alarm class	2	Class A, Class B, Class C, Class D, Class E, Class F , Control [Class B]	Each limit may be assigned an independent alarm class that specifies what action should be taken when the limit is surpassed.
5019	Delay	2	0.2 to 999.9 s [3.0 s]	The redundancy lost error can be delayed according to the application.
5020	Self acknowledge	2	No	No: The control unit does not automatically reset the alarm when the fault condition is no longer detected.
			[Yes]	Yes The control unit automatically clears the alarm if the fault condition is no longer detected.
5021	Enabled	2	[Always]	Always: Monitoring for this fault condition is continuously enabled.
			87.70 LM:Eng.mon	Monitoring for fault conditions is not performed until engine monitoring is enabled. This is determined through the LogicsManager equation "Release engine monitoring".
			For xx = 1 to 32: 96.{xx} LM: Flag{xx}	The monitoring is executed, if the LogicsManager "Flag {xx}" is TRUE. Example: 96.01 LM: Flag 1, 96.02 LM: Flag 2, ..., 96.32 LM: Flag 32

Table 92: Parameter: Monitoring

4.6 Configure Measurement

General notes



If the genset control is intended to operate a genset in parallel to the mains, the mains voltage measuring inputs must be connected.

Dependencies

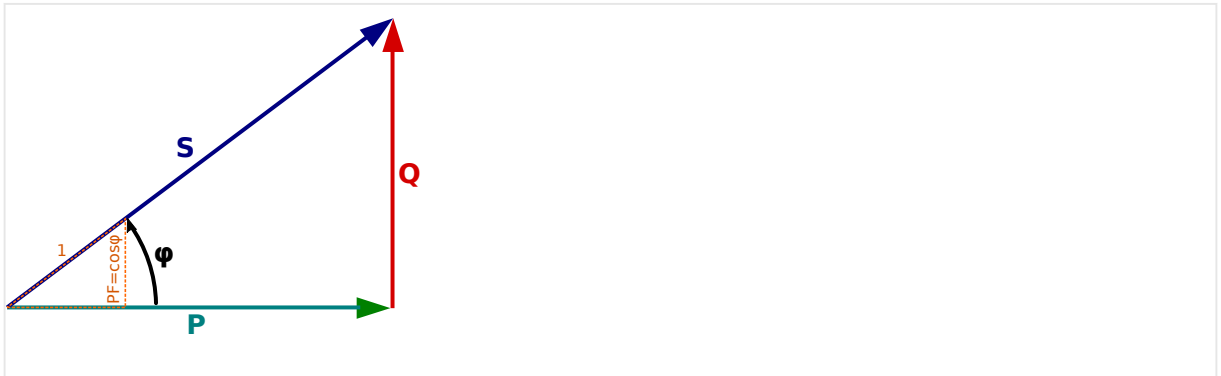

Fig. 230: AC power triangle

- PF Power Factor
- P Active Power [kW]
- S Apparent power [kVA]
- Q Reactive Power [kvar]

The AC power triangle illustrates the dependencies between active power, apparent power, reactive power and power factor.

- $PF = P/S = \cos \phi$
- $Q = \sqrt{S^2 - P^2}$
- $S = \sqrt{P^2 + Q^2}$
- $P = S * PF$

4.6.1 General measurement settings

ID	Parameter	CL	Setting range [Default]	Description
1750	System rated frequency	2	50Hz / 60Hz [50Hz]	The rated frequency of the system is used as a reference figure for all frequency related functions, which use a percentage value, like frequency monitoring, breaker operation windows or the AnalogManager.
1825	System rated active power[kW]	2	0.5 to 99999.9 kW [200.0 kW]	This value specifies 100% of the system rated power, which is used for system related indications and calculations. The AnalogManager "10.11 System nominal P [%]" and "10.12 System real P [%]" are related to this value or setting.
1858	1Ph2W voltage measuring	3	[Phase - phase]	The unit is configured for measuring phase-phase voltages if 1Ph 2W measuring is selected.

ID	Parameter	CL	Setting range [Default]	Description
			Phase - neutral	The unit is configured for measuring phase-neutral voltages if 1Ph 2W measuring is selected.
				<p>Notes</p> <p>For information on measuring principles refer to ↪ "3.3.5.1 Generator Voltage".</p> <p>Never configure the busbar measurement for phase-neutral, if the other systems like mains and generator are configured as 3ph 3W or 3ph 4W without being the neutral in the middle of the triangle. The phase angle for synchronization would be not correct.</p>
1859	1Ph2W phase rotation	3	[CW]	A clockwise rotation field is considered for 1Ph 2W measuring .
			CCW	A counter-clockwise rotation field is considered for 1Ph 2W measuring.
				<p>Notes</p> <p>For information on measuring principles refer to ↪ "3.3.5.1 Generator Voltage".</p>
1854	Additional CT input	2	[Mains current] Ground current Off	This parameter configures whether ground or mains current is measured on terminals ½ or the input is disabled.
1835	Ground current range	2	1A [5A]	Application specific ground current range must be selected e.g. for rated values.
1810	Gnd. CT primary rated current	2	[500 A/x] 1..3200 A/x	CT ground current measuring primary rated value.
				<p>Notes</p> <p>Available if parameter »1854 Additional CT input «is set to »Ground current«.</p> <p>»A/x«: "/x" shows the relation to the current range which can be selected (1 A or 5 A).</p>

4.6.2 Generator

ID	Parameter	CL	Setting range [Default]	Description
235	Generator type	2		<p>The genset control supports two types of generators:</p> <ul style="list-style-type: none"> • synchronous generators • asynchronous generators (induction generators)
			[Synchron]	<p>The unit provides all functions which are needed for synchronous generator applications. islanded and mains parallel operation is supported.</p>
			Asynchron	<p>The unit provides the special function of the asynchronous generator with:</p> <ul style="list-style-type: none"> • The speed is regulated with the speed signal from the MPU or J1939/CAN input (as long as the GCB is open). • The closing of the GCB is executed, if the speed is within the corresponding frequency range of the generator operating window. The voltage and phase angle is ignored in this case. • The generator monitoring (under/over frequency and under/overvoltage/ asymmetry) is switched off, until the generator breaker is closed. • After opening the GCB, under/over frequency and under/overvoltage and asymmetry monitoring is switched on again. • The Frequency/MPU speed plausibility monitoring is only active, if the GCB is closed. • The synchroscope is not displayed in the asynchronous modus.
				<p>Notes</p> <p>The asynchronous mode is used in slip synchronization only (Synchronization GCB (parameter ↩> 5729) = Slip frequency.</p>
			<p>Recommended settings</p> <p>The asynchronous modus is normally used in mains parallel operation. Please consider the following settings:</p> <ul style="list-style-type: none"> • Application mode (parameter ↩> 3444) = GCB 	

ID	Parameter	CL	Setting range [Default]	Description
				<ul style="list-style-type: none"> Mains decoupling (parameter ↗ 3110) = GCB MPU input (parameter ↗ 1600) = On Generator operating frequency (parameter ↗ 5802, ↗ 5803)
				<p>Notes</p> <p>The asynchron mode is not recommended for emergency power applications.</p>
1766	Generator rated voltage	2	50 to 650000 V [400 V]	<p>This value refers to the rated voltage of the generator (generator voltage on data plate) and is the voltage measured on the potential transformer primary.</p> <p>The generator rated voltage is used as a reference figure for all generator voltage related functions, which use a percentage value, like generator voltage monitoring, breaker operation windows or the AnalogManager.</p>
1752	Gen. rated active power [kW]	2	0.5 to 99999.9 kW [200.0 kW]	<p>This value specifies the generator real power rating, which is used as a reference figure for related functions. The generator rated active power is the generator apparent power multiplied by the generator power factor (typically ~0.8). These values are indicated in the generator data plate (↗ "Dependencies").</p>
1758	Gen. rated react. power [kvar]	2	0.5 to 99999.9 kvar [200.0 kvar]	<p>This value specifies the generator reactive power rating, which is used as a reference figure for related functions. The generator rated reactive power also depends on the generator values (↗ "Dependencies").</p>
1754	Generator rated current	2	1 to 32000 A [300 A]	<p>This value specifies the generator rated current, which is used as a reference figure for related functions.</p>
1851	Generator voltage measuring	2	3Ph 4W OD	<p>Measurement is performed Line-Neutral (Open Delta connected system). The voltage is connected via transformer with 3 Wire.</p> <p>Phase voltages and the neutral must be connected for proper calculation.</p> <p>Measurement, display and protection are adjusted according to the rules for Open Delta connected systems.</p> <p>Monitoring refers to the following voltages:</p>

ID	Parameter	CL	Setting range [Default]	Description
				<ul style="list-style-type: none"> VL12, VL23 and VL31
			1Ph 3W	<p>Measurement is performed Line-Neutral (WYE connected system) and Line-Line (Delta connected system). The protection depends on the setting of parameter ↩➤ 1770.</p> <p>Measurement, display, and protection are adjusted according to the rules for single-phase systems.</p> <p>Monitoring refers to the following voltages:</p> <ul style="list-style-type: none"> VL13 (parameter ↩➤ 1770 configured to "Phase-phase") VL1N, VL3N (parameter ↩➤ 1770 configured to "Phase-neutral")
			1Ph 2W	<p>Measurement is performed Line-Neutral (WYE connected system) if parameter ↩➤ 1858 is configured to "Phase - neutral" and Line-Line (Delta connected system) if parameter ↩➤ 1858 is configured to "Phase - phase".</p> <p>Measurement, display and protection are adjusted according to the rules for phase-phase systems.</p> <p>Monitoring refers to the following voltages:</p> <ul style="list-style-type: none"> VL1N, VL12
			3Ph 3W	<p>Measurement is performed Line-Line (Delta connected system). Phase voltages must be connected for proper calculation.</p> <p>Measurement, display and protection are adjusted according to the rules for Delta connected systems.</p> <p>Monitoring refers to the following voltages:</p> <ul style="list-style-type: none"> VL12, VL23, VL31
			[3Ph 4W]	<p>Measurement is performed Line-Neutral (WYE connected system) and Line-Line (Delta connected system). The protection depends on the setting of parameter ↩➤ 1770.</p> <p>Phase voltages and the neutral must be connected for proper calculation. Measurement, display and protection are adjusted</p>

ID	Parameter	CL	Setting range [Default]	Description
				<p>according to the rules for WYE connected systems.</p> <p>Monitoring refers to the following voltages:</p> <ul style="list-style-type: none"> VL12, VL23 and VL31 (parameter ↩ 1770 configured to "Phase-phase") VL1N, VL2N and VL3N (parameter ↩ 1770 configured to "Phase-neutral")
				<p>Notes</p> <p>If this parameter is configured to 1Ph 3W, the generator and mains rated voltages (parameters ↩ 1766 and ↩ 1768) must be entered as Line-Line (Delta) and the busbar 1 rated voltage (parameter ↩ 1781) must be entered as Line-Neutral (WYE).</p> <p>For information on measuring principles refer to ↩ "3.3.5.1 Generator Voltage".</p>
1850	Generator current measuring	2	[L1 L2 L3]	<p>All three phases are monitored. Measurement, display and protection are adjusted according to the rules for 3-phase measurement. Monitoring refers to the following currents: IL1, IL2, IL3</p>
			Phase L1 Phase L2 Phase L3	<p>Only one phase is monitored. Measurement, display and protection are adjusted according to the rules for single-phase measurement.</p> <p>Monitoring refers to the selected phase.</p>
				<p>Notes</p> <p>This parameter is only effective if generator voltage measuring (parameter ↩ 1851) is configured to "3Ph 4W" or "3Ph 3W".</p> <p>For information on measuring principles refer to ↩ "3.3.6.1 Generator Current".</p>

4.6.2.1 Configure transformer

General notes

The setpoints for specific parameters will differ depending upon the setting of parameter »Generator current range« [↩ 1830](#).

- 1830 = "1A": Current transformer with ../1 A rated current

- 1830 = "5A": Current transformer with ..5 A rated current

ID	Parameter	CL	Setting range [Default]	Description
1801	Gen. PT primary rated voltage (Generator potential transformer primary voltage rating)	2	50 to 650000 V [400 V]	Some generator applications may require the use of potential transformers to facilitate measuring the voltages produced by the generator. The rating of the primary side of the potential transformer must be entered into this parameter. If the application does not require potential transformers (i.e. the measured voltage is 690 V or less), then the measured voltage will be entered into this parameter.
1800	Gen. PT secondary rated volt. (Generator potential transformer secondary voltage rating)	2	50 to 690 V [400 V]	Some generator applications may require the use of potential transformers to facilitate measuring the voltages produced by the generator. The rating of the secondary side of the potential transformer must be entered into this parameter. If the application does not require potential transformers (i.e. the measured voltage is 690 V or less), then the measured voltage will be entered into this parameter.
1806	Gen. CT primary rated current (Generator current transformer primary rating)	2	1 to 32000 A/x [500 A/x]	The input of the current transformer ratio is necessary for the indication and control of the actual monitored value. Notes The current transformers ratio should be selected so that at least 60% of the secondary current rating can be measured when the monitored system is at 100% of operating capacity (i.e. at 100% of system capacity a 5 A CT should output 3 A). If the current transformers are sized so that the percentage of the output is lower, the loss of resolution may cause inaccuracies in the monitoring and control functions and affect the functionality of the control. »A/x«: "/x" shows the relation to the current range which can be selected (1 A or 5 A).
1830	Generator current range	2	1A	The input range of the current transformer must be selected/ defined.

ID	Parameter	CL	Setting range [Default]	Description
			[5A]	

4.6.3 Busbar



The busbar parameters in the device are often named with the affix "1". This preparation is done to avoid confusion e.g., if a model with a second busbar measurement is introduced.

ID	Parameter	CL	Setting range [Default]	Description
1781	Busbar 1 rated voltage	2	50 to 650000 V [400 V]	<p>This value refers to the rated voltage of busbar 1 and is the voltage measured on the potential transformer primary.</p> <p>If voltage measuring is configured to 1Ph 3W, the WYE voltage (VL1N) must be entered here.</p> <p>The busbar 1 potential transformer primary voltage is entered in this parameter. The busbar rated voltage is used as a reference figure for all busbar voltage related functions, which use a percentage value, like synchronization.</p>
1856	Busbar 1 voltage measuring	2	[3Ph 4W]	<p>Busbar 1 measurement allows 1 phase or 3 phases to be measured with 2, 3, or 4 wires connected.</p> <p>Measurement is performed Line-Neutral (WYE connected system) and Line-Line (Delta connected system). The protection depends on the setting of parameter 1770.</p> <p>Phase voltages and the neutral must be connected for proper calculation. Measurement, display, and protection are adjusted according to the rules for WYE connected systems.</p> <p>Monitoring refers to the following voltages:</p> <ul style="list-style-type: none"> VL12, VL23, and VL31 (parameter 1770 configured to "Phase-phase") VL1N, VL2N, and VL3N (parameter 1770 configured to "Phase-neutral")
			3Ph 3W	Measurement is performed Line-Line (Delta connected system).

ID	Parameter	CL	Setting range [Default]	Description
				<p>Phase voltages must be connected for proper calculation.</p> <p>Measurement, display, and protection are adjusted according to the rules for Delta connected systems.</p> <p>Monitoring refers to the following voltages:</p> <ul style="list-style-type: none"> • VL12, VL23, and VL31
			1Ph 2W	<p>Measurement is performed Line-Neutral (WYE connected system) if parameter ↩ 1858 is configured to "Phase - neutral" or Line-Line (Delta connected system) if parameter ↩ 1858 is configured to "Phase - phase".</p> <p>Measurement, display, and protection are adjusted according to the rules for phase-phase systems.</p> <p>Monitoring refers to the following voltages:</p> <ul style="list-style-type: none"> • VL1N and VL12
			1Ph 3W	<p>Measurement is performed Line-Neutral (WYE connected system) or Line-Line (Delta connected system). The protection depends on the setting of parameter ↩ 1770.</p> <p>Measurement, display, and protection are adjusted according to the rules for single-phase systems.</p> <p>Monitoring refers to the following voltages:</p> <ul style="list-style-type: none"> • VL13 (parameter ↩ 1770 configured to "Phase-phase") • VL1N and VL3N (parameter ↩ 1770 configured to "Phase-neutral")
5820	Dead bus detection max. volt.	2	0 to 30% [10%]	<p>If the busbar voltage falls below this percentage of the busbar 1 rated voltage (parameter ↩ 1781), a dead bus condition is detected and the logical command variable "02.21 Dead busbar1" becomes TRUE.</p>

4.6.3.1 Configure transformer

ID	Parameter	CL	Setting range [Default]	Description
1813	Bus1 PT primary rated voltage (Busbar 1 potential transformer primary voltage rating)	2	50 to 650000 V [400 V]	Some applications may require the use of potential transformers to facilitate measuring the voltages to be monitored. The rating of the primary side of the potential transformer must be entered into this parameter.
				Notes If the application does not require potential transformers (i.e. the measured voltage is 690 V or less), then the measured voltage will be entered into this parameter.
1812	Bus1 PT secondary rated volt. (Busbar 1 potential transformer secondary voltage rating)	2	50 to 690 V [400 V]	Some applications may require the use of potential transformers to facilitate measuring the busbar voltages. The rating of the secondary side of the potential transformer must be entered into this parameter. If the application does not require potential transformers (i.e. the measured voltage is 690 V or less), then the measured voltage will be entered into this parameter.

4.6.4 Mains

ID	Parameter	CL	Setting range [Default]	Description
1768	Mains rated voltage	2	50 to 650000 V [400 V]	This value refers to the rated voltage of the mains and is the voltage measured on the potential transformer primary. The mains potential transformer primary voltage is entered in this parameter. The mains rated voltage is used as a reference figure for all mains voltage related functions, which use a percentage value, like mains voltage monitoring, breaker operation windows or the AnalogManager.
1748	Mains rated active power [kW]	2	0.5 to 99999.9 kW [200.0 kW]	This value specifies the mains real power rating, which is used as a reference figure for related functions. The mains rated active power is a reference value used by several monitoring and control functions (↳ "Dependencies").

ID	Parameter	CL	Setting range [Default]	Description
1746	Mains rated react. pwr. [kvar]	2	0.5 to 99999.9 kvar [200.0 kvar]	<p>This value specifies the mains reactive power rating, which is used as a reference figure for related functions.</p> <p>The mains rated reactive power is a reference value used by several monitoring and control functions(↪ "Dependencies").</p>
1785	Mains rated current	2	1 to 32000 A [300 A]	<p>This value specifies the mains rated current, which is used as a reference figure for related functions.</p>
1853	Mains voltage measuring	2	[3Ph 4W]	<p>Measurement is performed Line-Neutral (WYE connected system) and Line-Line (Delta connected system). The protection depends on the setting of parameter ↪ 1771.</p> <p>Phase voltages and the neutral must be connected for proper calculation. Measurement, display and protection are adjusted according to the rules for WYE connected systems.</p> <p>Monitoring refers to the following voltages:</p> <ul style="list-style-type: none"> • VL12, VL23 and VL31 (parameter ↪ 1771 configured to "Phase-phase") • VL1N, VL2N and VL3N (parameter ↪ 1771 configured to "Phase-neutral") • VL12, VL23, VL31, VL1N, VL2N and VL3N (parameter ↪ 1771 configured to "All")
			3Ph 3W	<p>Measurement is performed Line-Line (Delta connected system). Phase voltages must be connected for proper calculation.</p> <p>Measurement, display and protection are adjusted according to the rules for Delta connected systems.</p> <p>Monitoring refers to the following voltages:</p> <ul style="list-style-type: none"> • VL12, VL23, VL31
			1Ph 2W	<p>Measurement is performed Line-Neutral (WYE connected system) if parameter ↪ 1858 is configured to "Phase - neutral" and Line-Line (Delta connected system) if parameter ↪ 1858 is configured to "Phase - phase".</p> <p>Measurement, display and protection are adjusted according</p>

ID	Parameter	CL	Setting range [Default]	Description
				<p>to the rules for phase-phase systems.</p> <p>Monitoring refers to the following voltages:</p> <ul style="list-style-type: none"> • VL1N, VL12
			1Ph 3W	<p>Measurement is performed Line-Neutral (WYE connected system) and Line-Line (Delta connected system).</p> <p>The protection depends on the setting of parameter ↩ 1771. Measurement, display, and protection are adjusted according to the rules for single-phase systems.</p> <p>Monitoring refers to the following voltages:</p> <ul style="list-style-type: none"> • VL13 (parameter ↩ 1771 configured to "Phase-phase") • VL1N, VL3N (parameter ↩ 1771 configured to "Phase-neutral") • VL1N, VL3N (parameter ↩ 1771 configured to "All")
				<p>Notes</p> <p>If this parameter is configured to 1Ph 3W, the generator and mains rated voltages (parameters ↩ 1766 and ↩ 1768) must be entered as Line-Line (Delta) and the busbar 1 rated voltage (parameter ↩ 1781) must be entered as Line-Neutral (WYE).</p>
1852	Mains current measuring	2	<p>[Phase L1]</p> <p>Phase L2</p> <p>Phase L3</p>	<p>Phase L_{1/2/3} Measurement is performed for the selected phase only. The measurement and display refer to the selected phase.</p> <p>The configured phase CT must be connected to perform current measurement.</p>
				<p>Notes</p> <p>For information on measuring principles refer to ↩ "3.3.6.2 Mains Current".</p> <p>This parameter is only effective if mains voltage measuring (parameter ↩ 1853) is configured to "3Ph 4W" or "3Ph 3W".</p>

4.6.4.1 Configure transformer

General notes

The setpoints for specific parameters will differ depending upon the setting of parameter »Mains current range«  1832.

- 1832 = "1A": Current transformer with ../1 A rated current
- 1832 = "5A": Current transformer with ../5 A rated current

ID	Parameter	CL	Setting range [Default]	Description
1804	Mains PT primary rated voltage (Mains potential transformer primary voltage rating)	2	50 to 650000 V [400 V]	Some applications may require the use of potential transformers to facilitate measuring the voltages to be monitored. The rating of the primary side of the potential transformer must be entered into this parameter.
				Notes If the application does not require potential transformers (i.e. the measured voltage is 690 V or less), then the measured voltage will be entered into this parameter.
1803	Mains PT secondary rated volt. (Mains potential transformer secondary voltage rating)	2	50 to 690 V [400 V]	Some applications may require the use of potential transformers to facilitate measuring the mains voltages. The rating of the secondary side of the potential transformer must be entered into this parameter. If the application does not require potential transformers (i.e. the measured voltage is 690 V or less), then the measured voltage will be entered into this parameter.
1807	Mains CT primary rated current (Mains current transformer primary rating)	2	1 to 32000 A/x [500 A/x]	The input of the current transformer ratio is necessary for the indication and control of the actual monitored value. The current transformers ratio should be selected so that at least 60% of the secondary current rating can be measured when the monitored system is at 100% of operating capacity (i.e. at 100% of system capacity a 5 A CT should output 3 A). If the current transformers are sized so that the percentage of the output is lower, the loss of resolution may cause inaccuracies in the monitoring and control functions and affect the functionality of the control.
				Notes

ID	Parameter	CL	Setting range [Default]	Description
				This screen is only visible if parameter ↩ 1854 is configured as Mains.
1832	Mains current range	2	1A [5A]	<p>The input range of the current transformer must be selected/defined.</p> <p>Notes</p> <p>This screen is only visible if parameter ↩ 1854 is configured as Mains.</p>

4.6.4.2 External Mains Active Power

ID	Parameter	CL	Setting range [Default]	Description
2966	External mains active power	2	Yes	<p>The mains active power is coming from an external source.</p> <p>The following measurement values of the external mains active power depend on the external mains reactive power measurement. So there is to differentiate between two cases:</p> <p>Case 1: External mains reactive power measurement (parameter ↩ 2969) is disabled:</p> <ul style="list-style-type: none"> • The mains power factor is assumed as "1". • The mains power factor monitoring is switched off. • The mains power factor is not displayed. • The mains total reactive power is not displayed. <p>Case 2: External mains reactive power measurement (parameter ↩ 2969) is enabled:</p> <ul style="list-style-type: none"> • The mains power factor is calculated. • The mains power factor monitoring is switched off. • The mains power factor is not displayed. • The mains total reactive power is not displayed. • The mains total apparent power is calculated and displayed. <p>Notes</p>

4 Configuration

4.6.4.3 External Mains Reactive Power

ID	Parameter	CL	Setting range [Default]	Description
				<p>Mains power monitoring is not available.</p> <p>Please make sure to assign the external mains active power to the corresponding analog data source (parameter ↩ 5780). The same data source must be used if the mains active power is requested via interface.</p>
			[No]	The mains active power is internally measured.
5780	AM Ext.mains act.pwr	2	Determined by AnalogManager 81.19: [A1 = 06.01 Analog input 1]	Typically an analog input is selected as data source which is connected to an external transducer.
2967	Mains power meas. resolution (Mains power measurement resolution)	2		This parameter controls the resolution and the format.
			Selected resolution	Power at 100 % analog value
			0.01kW	10.00 kW
			0.1kW	100.0 kW
			[1kW]	1000 kW
			0.01MW	10.00 MW
			0.1MW	100.0 MW

4.6.4.3 External Mains Reactive Power

ID	Parameter	CL	Setting range [Default]	Description
2969	External mains reactive power	2	Yes	<p>The mains reactive power is coming from an external source. This power is displayed and used for control purposes. The source is taken via AnalogManager.</p> <p>The following measurement values depend on the external mains active power measurement. So there is to differentiate between two cases:</p> <p>Case 2: External mains active power measurement (parameter ↩ 2966) is disabled:</p> <ul style="list-style-type: none"> • The mains power factor is assumed as "1". • The mains active power monitoring is switched off. • The mains power factor monitoring is switched off. • The mains power factor is not displayed.

ID	Parameter	CL	Setting range [Default]	Description
				<ul style="list-style-type: none"> The mains total active power is not displayed. <p>Case 1: External mains active power measurement (parameter 2966) is enabled:</p> <ul style="list-style-type: none"> The mains power factor is calculated. The mains power factor monitoring is switched off. The mains power factor is not displayed. The mains total reactive power is not displayed. The mains total apparent power is calculated and displayed. <p>Notes</p> <p>Mains power monitoring is not available.</p> <p>Please make sure to assign the external mains reactive power to the corresponding analog data source (parameter ↔ 5794). The same data source must be used if the mains active power is requested via interface.</p>
			[No]	The mains reactive power is internally measured.
5794	AM Ext.mains RPower	2	Determined by AnalogManager 81.20: [A1 = 06.02 Analog input 2]	Typically an analog input is selected as data source (kvar value) which is connected to an external transducer.
2970	Mains react.power meas.resol. (Mains reactive power measurement resolution)	2		This parameter controls the resolution and the format.
			Selected resolution:	Power at 100 % analog value:
			0.01kvar	10.00 kvar
			0.1kvar	100.0 kvar
			[1kvar]	1000 kvar
			0.01Mvar	10.00 Mvar
			0.1Mvar	100.0 Mvar

4.6.5 Engine

ID	Parameter	CL	Setting range [Default]	Description
1601	Engine rated speed	2	100 to 4,000 rpm	Number of revolutions per minute of the engine at rated engine

ID	Parameter	CL	Setting range [Default]	Description
			[1,500 rpm]	speed. The speed control with an ECU via J1939 CAN bus refers to this value.

4.7 Configure Interfaces

Interfaces / Communication Overview

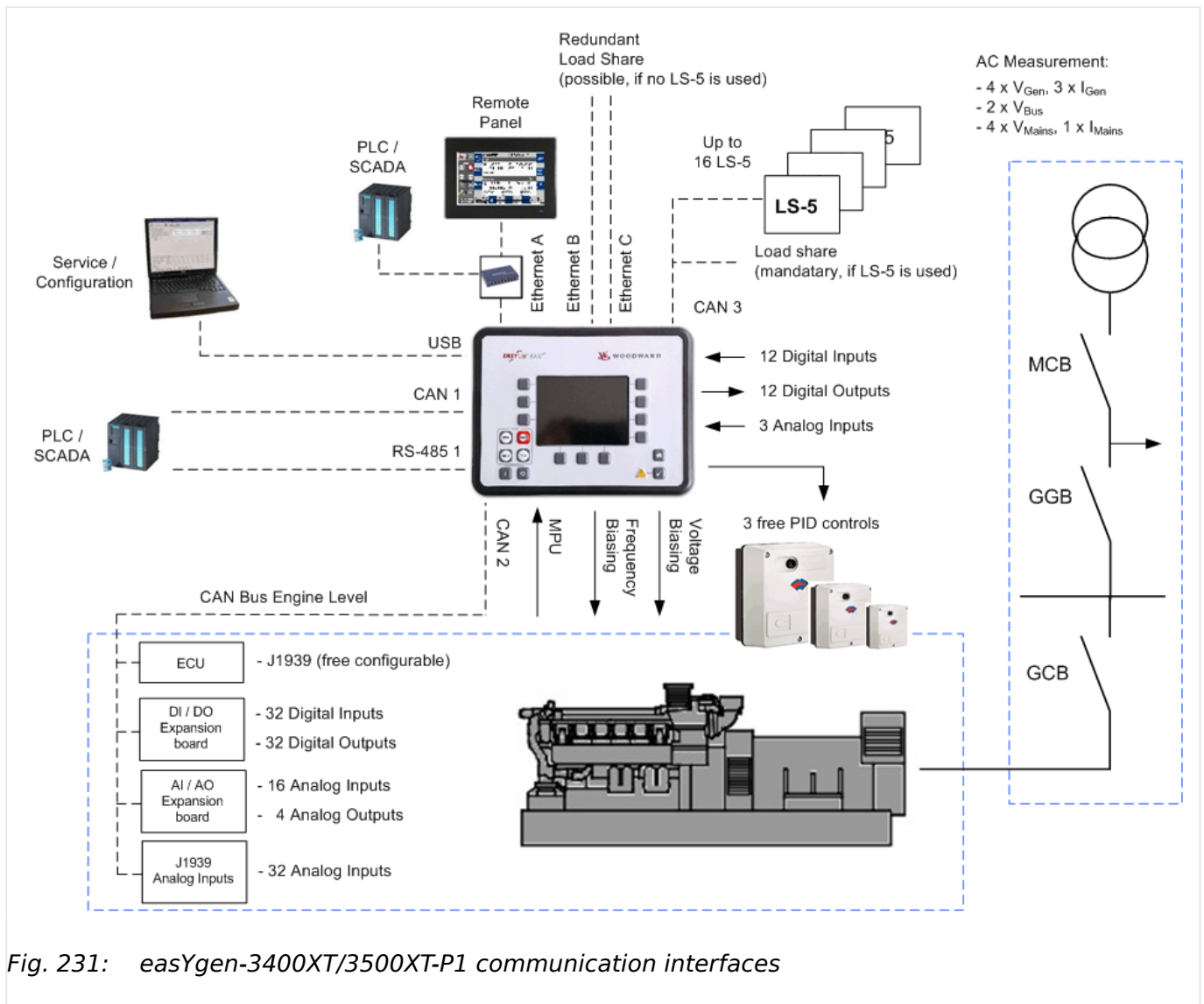

Fig. 231: easYgen-3400XT/3500XT-P1 communication interfaces

4.7.1 USB (Service Port) Interface

If the easYgen-XT is connected to a PC via USB port, the device appears as an USB drive. The drive contains e.g. the technical manual, appropriate configuration files and the virtual COM port driver to connect to the easYgen using ToolKit. If the PC does not install the COM port automatically, then the installer in folder "Driver" must be executed before starting ToolKit

There is no configuration to do for the USB Service Port.



USB Service Port

The USB service port is restricted for ToolKit communication, Woodward service communication, and - if provided by factory side - read only files.

The »Automatic Reconnection« over USB is not possible.

If connection over USB is lost, please reconnect manually:

- 1. Wait until the easYgen-XT is recognized again through the PC (as an external hard drive)
- 2. Start via ToolKit at new by "Disconnect" and then "Connect" again

4.7.2 RS-485 Interface

ID	Parameter	CL	Setting range [Default]	Description
3170	Baudrate	2	2400 Bd / 4800 Bd / 9600 Bd / [19.2 kBd] / 38.4 kBd / 56 kBd / 115 kBd	This parameter defines the baud rate for communications. Please note, that all participants on the bus must use the same baud rate.
3171	Parity	2	[No] / Even / Odd	The used parity of the interface is set here.
3172	Stop bits	2	[One] / Two	The number of stop bits is set here.
3173	Full-, halfduplex mode	2	[Fullduplex]	Fullduplex mode is enabled.
			Halfduplex	Half-duplex mode is enabled.
				Modbus Interface
3188	Modbus slave ID	2	0 to 255 [1]	The Modbus device address, which is used to identify the device via Modbus, is entered here. If "0" is configured here, the Modbus is disabled.
3189	Reply delay time	2	0.00 to 2.55 s [0.00 s]	This is the minimum delay time between a request from the Modbus master and the sent response of the slave. This time is required in half-duplex mode.
9128	Password protection	5	Off	Password protection for Modbus RS 485 is not active .
				Notes Take care for a protected access!
			[On]	Password protection for Modbus RS 485 is active.

4.7.3 Modbus Protocol



Data Format(s)

Modbus registers are read and written according to the Modbus standard as Big-endian.

Composite data types like LOGMAN, ANALOGMANAGER, and TEXT use separate descriptions.

ID	Parameter	CL	Setting range [Default]	Description
3184	Modbus protocol number	2	0 to 65535	<p>A Modbus protocol may be selected by entering the data protocol ID here. If an unknown data protocol ID is configured here, nothing will be transmitted. Possible data protocol IDs (existing protocols) are listed in this Technical Manual.</p> <p>Instead of a Woodward protocol, a customer specific data protocol can be selected. Such a protocol must have been uploaded onto the device and its file name must fit the reserved range from protocol number 65100 to 65199. Use Woodward "TelegramMapper" PC software to create your own Data Telegrams (refer to 6.5.4 Modbus Telegram Mapper (Customer Written Data Protocols)).</p> <p>Notes</p> <p>Another protocol can be used after a reboot of the control:</p> <p>Change Modbus protocol number first, then reboot 10419!</p>
			[5010]	<p>Number of the Data Telegram to be used for communication (corresponds to the file name [xxxx].scp).</p> <p>Notes</p> <p>All Date Telegrams described in this Technical Manual are device implemented: no separate scp-file (e.g. "5010.scp") needed.</p>
3179	Detect a gap in a Modbus frame	2	[On]	If a received Modbus command has a gap between its byte of more than 5 ms, this command is ignored.
			Off	The Modbus message is not checked.
3181	Power [W] exponent 10^x	2	2 to 5 [3]	This setting adjusts the format of the 16 bit power values in the data telegram.

ID	Parameter	CL	Setting range [Default]	Description
				<p>Notes</p> <p>Valid for data telegram 5010 only!</p> <p>Refer to ↗ “Power measurement example” for examples.</p>
3182	Voltage [V] exponent 10^x	2	-1 to 2 [0]	This setting adjusts the format of the 16 bit voltage values in the data telegram.
				<p>Notes</p> <p>Valid for data telegram 5010 only!</p> <p>Refer to ↗ “Voltage measurement example” for examples.</p>
3183	Current [A] exponent 10^x	2	-1 to 0 [0]	This setting adjusts the format of the 16 bit current values in the data telegram.
				<p>Notes</p> <p>Valid for data telegram 5010 only!</p> <p>Refer to ↗ “Power measurement example” for examples.</p>
3219	Modbus master	2	[Off]	The Modbus master function is disabled and no Modbus master requests are sent.
			0n	<p>The Modbus master function is requesting data according to the control file.</p> <p>Note</p> <p>Take care that a modbus master control file is already load into the device. For details refer to chapter ↗ “6.5.5 Modbus master”).</p>

Power measurement example

✧ **How to use Power exponent 3181**

Power measurement:

- The measurement range is 0...250 kW
- Momentary measurement value = 198.5 kW (198.500 W)

Setting value 3181	Meaning	Calculation	Transfer value (16 Bit, max. 32767)	Possible display format
2	10^2	198500 W / 10^2 W	1985	198.5 kW
3	10^3	198500 W / 10^3 W	198	198 kW
4	10^4	198500 W / 10^4 W	19	N/A
5	10^5	198500 W / 10^5 W	1	N/A

Table 93: Power measurement example

Voltage measurement example

✧ **How to use Voltage exponent 3182**

Voltage measurement:

- The measurement range is 0...480 V
- Momentary measurement value = 477.8 V

Setting	Meaning	Calculation	Transfer value (16 Bit, max. 32767)	Possible display format
-1	10^{-1}	477.8 V / 10^{-1} V	4778	477.8 V
0	10^0	477.8 V / 10^0 V	477	477 V
1	10^1	477.8 V / 10^1 V	47	N/A
2	10^2	477.8 V / 10^2 V	4	N/A

Table 94: Voltage measurement example

Current measurement example

* How to use Current exponent 3183

Current measurement:

- The measurement range is 0...500 A
- Momentary measurement value = 345.4 A

Setting	Meaning	Calculation	Transfer value (16 Bit, max. 32767)	Possible display format
-1	10 ⁻¹	345.4 A / 10 ⁻¹ A	3454	345.4 A
0	10 ⁰	345.4 A / 10 ⁰ A	345	345 A

Table 95: Current measurement example

4.7.4 CAN Interfaces

4.7.4.1 CAN Interface 1

General notes



The CAN bus is a field bus and subject to various disturbances. Therefore, it cannot be guaranteed that every request will be answered. We recommend to repeat a request, which is not answered within reasonable time.

COB-ID of SYNC/TIME messages



Parameters [↩ 9100](#) and [↩ 9101](#) use synchronization and time messages that adhere to the following structure.

Note: "Time consumer" via CAN3 interface has priority in comparison to CAN1. After factory default settings CAN3 is prepared to consume time (9104 COB-ID TIME Message = 0xC000 0100 refer to [↩ 9104](#)). If it is necessary to activate "Time consumer" over CAN 1, CAN3 "Time consumer" must be deactivate (via 9104 COB-ID TIME Message) over CAN3. Otherwise it will not be possible to receive time over CAN1.

Bit number	Value	Meaning
31 (MSB)	0	Unit does not consume TIME message
	1	Unit consumes TIME message
30	0	Unit does not generate SYNC/TIME message
	1	Unit generates SYNC/TIME message
29	X	N/A
28-11	0	Always 0
10-0 (LSB)	X	Bits 10-0 of SYNC/TIME COB-ID

TIME synchronization message

CANopen master	COB-ID TIME	Time consumer	Time transmitted
Off	Bit 31 = 0; Bit 30 = 0	No	No
	Bit 31 = 0; Bit 30 = 1	No	Yes
	Bit 31 = 1; Bit 30 = 0	Yes	No
	Bit 31 = 1; Bit 30 = 1	Yes	Yes
Default Master	Bit 31 = 0; Bit 30 = 0	No	No
	Bit 31 = 0; Bit 30 = 1	No	Yes ¹
	Bit 31 = 1; Bit 30 = 0	Yes	No
	Bit 31 = 1; Bit 30 = 1	Yes	Yes ¹
On	Bit 31 = 0; Bit 30 = 0	No	No
	Bit 31 = 0; Bit 30 = 1	No	Yes
	Bit 31 = 1; Bit 30 = 0	Yes	No
	Bit 31 = 1; Bit 30 = 1	Yes	Yes



¹ If CANopen master (lowest Node-ID).

ID	Parameter	CL	Setting range [Default]	Description
3156	Baudrate	2	20 kBd / 50 kBd / 100 kBd / 125 kBd / 250 kBd / 500 kBd / 800 kBd / 1000 kBd [250 kBd]	This parameter defines the used baud rate. Please note, that all participants on the CAN bus must use the same baud rate.
1894	Align device no. with Node-ID	2	No [Yes]	<p>If this parameter is configured to "Yes" the parameter »Node-ID CAN bus 1« ↔ 8950 will be overwritten with the value of the »Device number « ↔ 1702 and is not visible.</p> <p>If configured to "No", parameter »Device number « 1702 is visible and will not be overwritten.</p> <p>Notes</p> <p>This is to avoid CAN ID conflict in multi unit systems if using the same ID more than one time. This can cause CAN "Bus-Off" failure.</p>
8950	Node-ID CAN bus 1	2	1 to 127 (dec) [1]	<p>A number that is unique to the control must be set in this parameter so that this control unit can be correctly identified on the CAN bus.</p> <p>This address number may only be used once on the CAN bus. All</p>

ID	Parameter	CL	Setting range [Default]	Description
				<p>additional addresses are calculated based on this unique device number.</p> <p>Notes</p> <p>We recommend to configure the Node-IDs for units, which participate in load sharing, as low as possible to facilitate establishing of communication.</p>
8993	CANopen Master	2		One bus participant must take over the network management and put the other participants into "operational" mode. The easYgen is able to perform this task.
			[Default Master]	The unit starts up in "operational" mode and sends a "Start_Remote_node" message after a short delay (the delay is the Node-ID (parameter ↪ 8950) in seconds, i.e. if the Node-ID is configured to 2, the message will be sent after 2 seconds). If more than one easYgen is configured to Default Master, the unit with the lower Node-ID will take over control. Therefore, the CAN bus devices, which are intended to act as Default Master should be assigned a low Node-ID. No other device on the CAN bus (except the easYgens) may operate as Master).
			On	The unit is the CANopen Master and automatically changes into operational mode and transmits data.
			Off	The unit is a CANopen Slave. An external Master must change into operational mode.
				<p>Notes</p> <p>If this parameter is configured to "Off", the Master controller (for example a PLC) must send a "Start_Remote_node" message to initiate the load share message transmission of the easYgen.</p> <p>If no "Start_Remote_node" message would be sent, the complete system would not be operational.</p>
9120	Producer heartbeat time	2	0 to 65500 ms [2000 ms]	<p>Independent from the CANopen Master configuration, the unit transmits a heartbeat message with this configured heartbeat cycle time.</p> <p>If the producer heartbeat time is equal 0, the heartbeat will only be sent as response to a remote frame request. The time</p>

ID	Parameter	CL	Setting range [Default]	Description
				configured here will be rounded up to the next 20 ms step.
9100	COB-ID SYNC Message	2	1 to FFFFFFFF hex [80 hex]	This parameter defines whether the unit generates the SYNC message or not. The message complies with CANopen specification: object 1005 hex; subindex 0 defines the COB-ID of the synchronization object (SYNC).
				Notes The structure of this object is shown in ↪ "COB-ID of SYNC/TIME messages"
8940	Producer SYNC Message time	2	0 to 65000 ms [20 ms]	This is the cycle time of the SYNC message. If the unit is configured for this function (parameter ↪ 9100) it will send the SYNC message with this interval. The time configured here will be rounded up to the next 10 ms step.
9101	COB-ID TIME Message	2	1 to FFFFFFFF hex [100 hex]	This parameter defines whether the unit generates the TIME message or not. Complies with CANopen specification: object 1012 hex, subindex 0; defines the COB-ID of the time object (TIME).
				Notes The structure of this object is shown in ↪ "COB-ID of SYNC/TIME messages"
9102	Cycle of TIME sync. message	2	1.0 to 6500.0 s [10.0 s]	This is the cycle time of the TIME message. If the unit is configured for this function (parameter ↪ 9101) it will send the TIME message with this interval.
				Notes The structure of this object is shown in ↪ "TIME synchronization message"
9126	Password protection	5	Off	Password protection for CAN 1 is not active .
			[On]	Notes Take care for a protected access! Password protection for CAN 1 is active.

4.7.4.1.1 Additional Server SDOs (Service Data Objects)

General notes

The CAN bus is a field bus and subject to various disturbances. Therefore, it cannot be guaranteed that every request will be answered. We recommend to repeat a request, which is not answered within reasonable time.

The first Node-ID is the standard Node-ID of CAN interface 1 (parameter  8950).

ID	Parameter	CL	Setting range [Default]	Description
12801	2. Node ID	2	0 to 127 (dec) [0]	In a multi-master application, each Master needs its own identifier (Node-ID) from the unit. in order to send remote signals (i.e. remote start, stop, shutdown, or acknowledge) to the unit. The additional SDO channel will be made available by configuring this Node-ID to a value different than zero. This is the additional CAN ID for the PLC.
12802	3. Node ID	2	0 to 127 (dec) [0]	In a multi-master application, each Master needs its own identifier (Node-ID) from the unit. in order to send remote signals (i.e. remote start, stop, shutdown, or acknowledge) to the unit. The additional SDO channel will be made available by configuring this Node-ID to a value different than zero. This is the additional CAN ID for the PLC.
12803	4. Node ID	2	0 to 127 (dec) [0]	In a multi-master application, each Master needs its own identifier (Node-ID) from the unit. in order to send remote signals (i.e. remote start, stop, shutdown, or acknowledge) to the unit. The additional SDO channel will be made available by configuring this Node-ID to a value different than zero. This is the additional CAN ID for the PLC.
12804	5. Node ID	2	0 to 127 (dec) [0]	In a multi-master application, each Master needs its own identifier (Node-ID) from the unit. in order to send remote signals (i.e. remote start, stop, shutdown, or acknowledge) to the unit. The additional SDO channel will be made available by configuring this Node-ID to a value different than

4 Configuration

4.7.4.1.2 Receive PDO {x} (Process Data Object)

ID	Parameter	CL	Setting range [Default]	Description
				zero. This is the additional CAN ID for the PLC.

4.7.4.1.2 Receive PDO {x} (Process Data Object)

General notes

RPDO mapping is carried out as shown in (➡ Fig. 232).

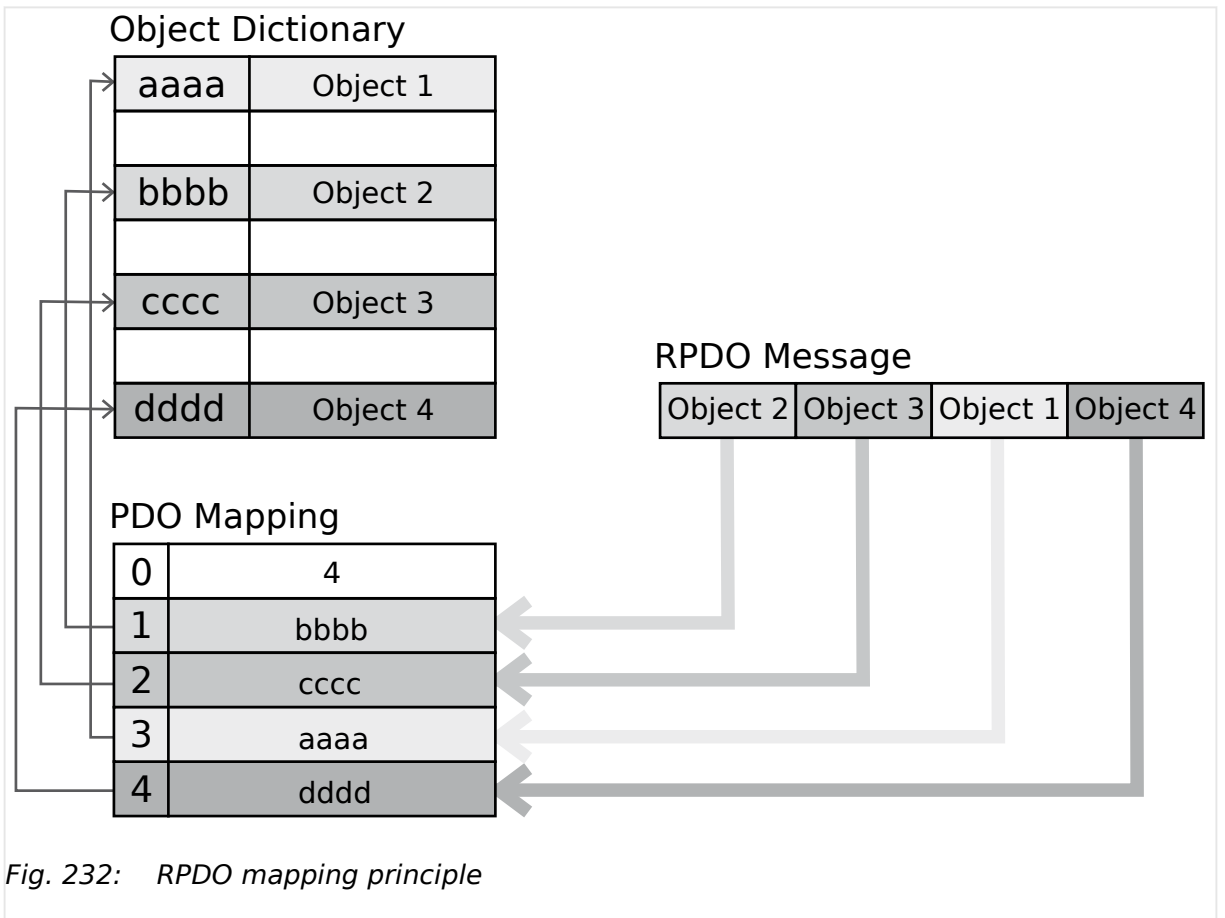

Parameters ➡ 9300/➡ 9310/➡ 9320/➡ 12805/➡ 12806 use communication parameters that adhere to the following structure.

RPDO Objects can be remote signals (parameter 503; please refer to ➡ “Remote control word 1” for details), DI states and AI measured values.

Bit number	Value	Meaning
31 (MSB)	0	PDO exists / is valid
	1	PDO does not exist / is not valid
30	X	N/A
29	X	N/A

Bit number	Value	Meaning
28-11	0	Always 0
10-0 (LSB)	X	Bits 10-0 of COB-ID



PDO valid / not valid allows to select, which PDOs are used in the operational state.

ID	Parameter	CL	Setting range [Default]	Description
9300 9310 9320 12805 12806	COB-ID	2	1 to FFFFFFFF hex [80000000 hex]	<p>This parameter contains the communication parameters for the PDOs, the device is able to receive.</p> <p>Complies with CANopen specification: object 1400 hex (for RPDO 1, 1401 hex for RPDO 2, 1402 hex for RPDO 3, 1403 hex for RPDO 4, and 1404 hex for RPDO 5), subindex 1.</p> <p>Notes</p> <p>The structure of this object is shown in Chapter 4.7.4.1.2.</p> <p>Do not configure an RPDO or TPDO with a COB-ID higher than 580 hex or lower than 180 hex. These IDs are reserved for internal purposes.</p>
9121 9122 9123 9124 9125	Event timer	2	0 to 65500 ms [2000 ms]	<p>This parameter configures the time, from which this PDO is marked as "not existing". The time configured here will be rounded up to the next 5 ms step. Received messages are processed by the control unit every 20 ms. Messages, which are sent faster, will be discarded. We recommend to configure ten times the cycle time of the received data here.</p> <p>Notes</p> <p>Complies with CANopen specification: object 1400 hex (for RPDO 1, 1401 hex for RPDO 2, 1402 hex for RPDO 3, 1403 hex for RPDO 4, and 1404 for RPDO 5), subindex 5</p>
8970 8971 8972 8973 8974	Selected Data Protocol	2	0 to 65535 [0]	<p>A data protocol may be selected by entering the data protocol ID here. If 0 is configured here, the message assembled by the mapping parameters is used. If an unknown data protocol ID is configured here, a failure is indicated by the CAN status bits. Possible data protocol IDs are:</p>

4 Configuration

4.7.4.1.2 Receive PDO {x} (Process Data Object)

ID	Parameter	CL	Setting range [Default]	Description
			65000	IKD 1 - external DIs/DOs 1 through 8
			65001	IKD 1 - external DIs/DOs 9 through 16
			65002	IKD 1 - external DIs/DOs 17 through 24
			65003	IKD 1 - external DIs/DOs 25 through 32
9910 9915 9905 12821 12831	Number of Mapped Objects	2	0 to 4 [0]	<p>This parameter defines the number of valid entries within the mapping record. This number is also the number of the application variables, which shall be received with the corresponding PDO.</p> <p>Notes</p> <p>Complies with CANopen specification: object 1600 hex (for RPDO 1, 1601 hex for RPDO 2, 1602 hex for RPDO 3, 1603 hex for RPDO 4, and 1604 hex for RPDO 5), subindex 0</p>
9911 9916 9906 12822 12832	1. Mapped Object	2	0 to 65535 [0]	<p>This parameter contains the information about the mapped application variables. These entries describe the PDO contents by their index. The sub-index is always 1. The length is determined automatically.</p> <p>Notes</p> <p>Complies with CANopen specification: object 1600 hex (for RPDO 1, 1601 hex for RPDO 2, 1602 hex for RPDO 3, 1603 hex for RPDO 4, and 1604 hex for RPDO 5), subindex 1.</p>
9912 9917 9907 12823 12833	2. Mapped Object	2	0 to 65535 [0]	<p>This parameter contains the information about the mapped application variables. These entries describe the PDO contents by their index. The sub-index is always 1. The length is determined automatically.</p> <p>Notes</p> <p>Complies with CANopen specification: object 1600 hex (for RPDO 1, 1601 hex for RPDO 2, 1602 hex for RPDO 3, 1603 hex for RPDO 4, and 1604 hex for RPDO 5), subindex 2.</p>
9913 9918 9908 12824	3. Mapped Object	2	0 to 65535 [0]	<p>This parameter contains the information about the mapped application variables. These entries describe the PDO contents by their index. The sub-index is always 1. The length is determined automatically.</p>

ID	Parameter	CL	Setting range [Default]	Description
12834				Notes Complies with CANopen specification: object 1600 hex (for RPDO 1, 1601 hex for RPDO 2, 1602 hex for RPDO 3, 1603 hex for RPDO 4, and 1604 hex for RPDO 5), subindex 3.
9914	4. Mapped Object	2	0 to 65535	This parameter contains the information about the mapped application variables. These entries describe the PDO contents by their index. The sub-index is always 1. The length is determined automatically.
9919			[0]	
9909				Notes Complies with CANopen specification: object 1600 hex (for RPDO 1, 1601 hex for RPDO 2, 1602 hex for RPDO 3, 1603 hex for RPDO 4, and 1604 hex for RPDO 5), subindex 4.
12825				
12835				

4.7.4.1.3 Transmit PDO {x} (Process Data Object)

General notes

TPDO mapping is carried out as shown in ( Fig. 233).

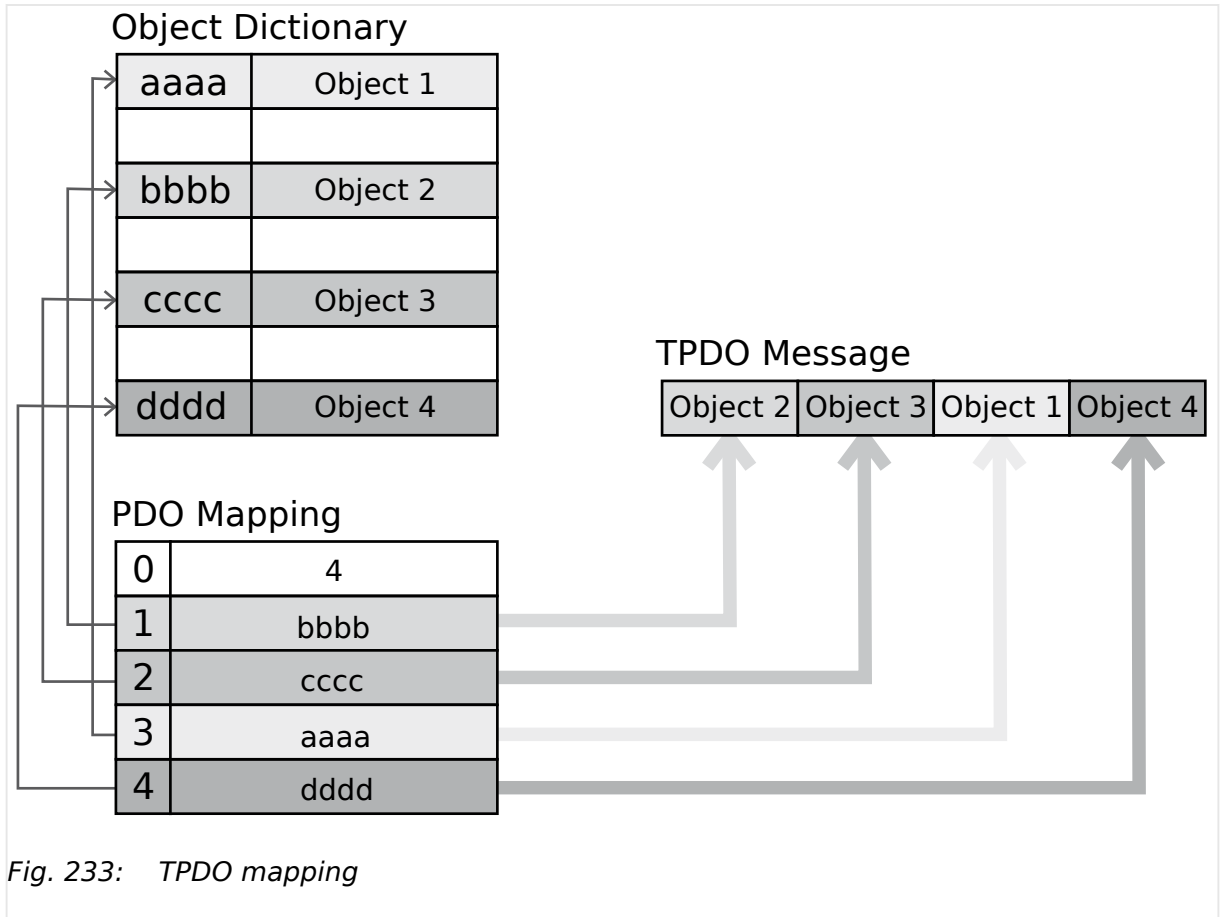

CANopen allows to send 8 byte of data with each Transmit PDO. These may be defined separately if no pre-defined data protocol is used.

All data protocol parameters with a parameter ID may be sent as an object with a CANopen Transmit PDO.

The data length will be taken from the data byte column (see [9.2 Data Protocols](#)):

- 1,2 UNSIGNED16 or SIGNED16
- 3,4 UNSIGNED16 or SIGNED16
- 5,6 UNSIGNED16 or SIGNED16
- 1,2,3,4 UNSIGNED32 or SIGNED32
- 3,4,5,6 UNSIGNED32 or SIGNED32
- etc.

The object ID is identical with the parameter ID when configuring via front panel or ToolKit.



Parameters [9600](#)/[9610](#)/[9620](#)/[9630](#)/[12792](#) use communication parameters that adhere to the following structure.

Bit number	Value	Meaning
31 (MSB)	0	PDO exists / is valid

Bit number	Value	Meaning
	1	PDO does not exist / is not valid
30	X	N/A
29	X	N/A
28-11	0	Always 0
10-0 (LSB)	X	Bits 10-0 of COB-ID



PDO valid / not valid allows to select, which PDOs are used in the operational state.

Transmission types



Parameters [↩ 9602](#)/[↩ 9612](#)/[↩ 9622](#)/[↩ 9632](#)/[↩ 12793](#) are used to select one of the following transmission types.

Transmission type	PDO transmission				
	Cyclic	Acyclic	Synchronous	Asynchronous	RTR only
0	Will not be sent				
1-240	X		X		
241-251	Will not be sent				
252	Will not be sent				
253	Will not be sent				
254				X	
255				X	



A value between 1 and 240 means that the PDO is transferred synchronously and cyclically. The transmission type indicating the number of SYNC messages, which are necessary to trigger PDO transmissions.

Transmit PDOs are always triggered by the following SYNC upon reception of data independent of the transmission types 0 to 240. For TPDOs, transmission type 254 and 255 means, the application event is the event timer.

ID	Parameter	CL	Setting range [Default]	Description
9600	COB-ID	2	1 to FFFFFFFF hex	This parameter contains the communication parameters for the PDOs the unit is able to transmit. The unit transmits data (i.e. visualization data) on the CAN ID configured here.
9610			[8000000 hex]	
9620				
9630				

4 Configuration

4.7.4.1.3 Transmit PDO {x} (Process Data Object)

ID	Parameter	CL	Setting range [Default]	Description
12792				<p>Complies with CANopen specification: object 1800 hex for (TPDO 1, 1801 hex for TPDO 2, 1802 hex for TPDO 3, 1803 hex for TPDO 4, and 1804 hex for TPDO 5), subindex 1.</p> <p>Notes</p> <p>The structure of this object is shown in Chapter 4.7.4.1.3</p> <p>Do not configure an RPDO or TPDO with a COB-ID higher than 580 hex or lower than 180 hex. These IDs are reserved for internal purposes.</p> <p>In case a LSG is part of CAN 1, do not configure COB-IDs 181 - 18E hex because legacy devices are using same IDs but cannot be switched.</p>
9602 9612 9622 9632 12793	Transmission type	2	0 to 255 [255]	<p>This parameter contains the communication parameters for the PDOs the unit is able to transmit. It defines whether the unit broadcasts all data automatically (value 254 or 255) or only upon request with the configured address of the COB-ID SYNC message (parameter 9100).</p> <p>Notes</p> <p>Complies with CANopen specification: object 1800 hex (for TPDO 1, 1801 hex for TPDO 2, 1802 hex for TPDO 3, 1803 hex for TPDO 4, and 1804 hex for TPDO 5), subindex 2.</p> <p>The description of the transmission type is shown in "Transmission types".</p>
9604 9614 9624 9634 12794	Event timer	2	0 to 65535 ms [20 ms]	<p>This parameter contains the communication parameters for the PDOs the unit is able to transmit. The broadcast cycle for the transmitted data is configured here. The time configured here will be rounded up to the next 5 ms step.</p> <p>Notes</p> <p>Complies with CANopen specification: object 1800 hex (for TPDO 1, 1801 hex for TPDO 2, 1802 hex for TPDO 3, 1803 hex for TPDO 4, and 1804 hex for TPDO 5), subindex 5</p>
8962 8963	Selected Data Protocol	2	0 to 65535 8962: [5003]	<p>A data protocol may be selected by entering the data protocol ID here. If 0 is configured here, the message assembled by the</p>

ID	Parameter	CL	Setting range [Default]	Description	
8964			8963: [5008]	mapping parameters is used. If an unknown data protocol ID is configured here, a failure is indicated by the CAN status bits. Possible data protocol IDs are:	
8965			8964: [0]		
8966			8965: [0]		
			8966: [0]		
			65000		IKD 1 - external DIs/DOs 1 through 8
			65001		IKD 1 - external DIs/DOs 9 through 16
			65002		IKD 1 - external DIs/DOs 17 through 24
			65003		IKD 1 - external DIs/DOs 25 through 32
			5003		Data telegram (CAN and MODBUS)
			5005		Data telegram (CAN mains values)
			5010		Data telegram (MODBUS)
	5011	Data telegram (CAN alarm values)			
9609	Number of Mapped Objects	2	0 to 4	This parameter contains the mapping for the PDOs the unit is able to transmit. This number is also the number of the application variables, which shall be transmitted with the corresponding PDO.	
9619			[0]		
9629					
9639					
12799					
				Notes Complies with CANopen specification: object 1A00 hex (for TPDO 1, 1A01 hex for TPDO 2, 1A02 hex for TPDO 3, 1A03 hex for TPDO 4, and 1A04 hex for TPDO 5), subindex 0	
9605	1. Mapped Object	2	0 to 65535	This parameter contains the information about the mapped application variables. These entries describe the PDO contents by their index. The sub-index is always 1. The length is determined automatically.	
9615			[0]		
9625					
9635					
12795					
				Notes Complies with CANopen specification: object 1A00 hex (for TPDO 1, 1A01 hex for TPDO 2, 1A02 hex for TPDO 3, 1A03 hex for TPDO 4, and 1A04 hex for TPDO 5), subindex 1	
9606	2. Mapped Object	2	0 to 65535	This parameter contains the information about the mapped application variables. These entries describe the PDO contents by their index. The sub-index is always 1. The length is determined automatically.	
9616			[0]		
9626					
9636					

ID	Parameter	CL	Setting range [Default]	Description
12796				Notes Complies with CANopen specification: object 1A00 hex (for TPDO 1, 1A01 hex for TPDO 2, 1A02 hex for TPDO 3, 1A03 hex for TPDO 4, and 1A04 hex for TPDO 5), subindex 2
9607 9617 9627 9637 12797	3. Mapped Object	2	0 to 65535 [0]	This parameter contains the information about the mapped application variables. These entries describe the PDO contents by their index. The sub-index is always 1. The length is determined automatically.
				Notes Complies with CANopen specification: object 1A00 hex (for TPDO 1, 1A01 hex for TPDO 2, 1A02 hex for TPDO 3, 1A03 hex for TPDO 4, and 1A04 hex for TPDO 5), subindex 3
9608 9618 9628 9638 12798	4. Mapped Object	2	0 to 65535 [0]	This parameter contains the information about the mapped application variables. These entries describe the PDO contents by their index. The sub-index is always 1. The length is determined automatically.
				Notes Complies with CANopen specification: object 1A00 hex (for TPDO 1, 1A01 hex for TPDO 2, 1A02 hex for TPDO 3, 1A03 hex for TPDO 4, and 1A04 hex for TPDO 5), subindex 4

4.7.4.2 CAN Interface 2

General notes



This CAN Interface is dedicated to

- J1939 devices and
- external CANopen devices with analog and/or digital terminals.

General Settings

ID	Parameter	CL	Setting range [Default]	Description
3157	Baudrate	2	20 kBd / 50 kBd / 100 kBd / 125 kBd / 250 kBd [250 kBd]	This parameter defines the used baud rate. Notes All participants on the CAN bus must use the same baud rate.

4.7.4.2.1 Expansion Modules at CANopen Interface

The CANopen interface at CAN 2 is very flexible.

The configuration of the expansion modules is split into two parts:

- One part is located at the CAN2 interface pages and defines the Node IDs and the types of external devices and is described here.

An application description explains the setup in detail (refer to [↪ “6.3.11 Setup Expansion Modules at CAN 2”](#)).

- One other part is located at the external analog/digital inputs/outputs pages and defines how many inputs/outputs are used and the scaling of the analog types. Refer to chapters [↪ “4.4.2.4 Analog Inputs”](#) for reference.
- Six Node-IDs can be selected to be used with different combinations of external terminals (“# Node-ID”, parameters 9930-9935)
- A number of well defined combinations is available for Woodward IKD (or two IKD-IN-16 and two IKD-OUT-16) and/or third party expansion modules from Phoenix and WAGO: (“Select external terminals”, parameter [↪ 15320](#))

This parameter defines the type and the maximal number of DI, DO, AI, AO combinations.

- Alternatively new combinations can be implemented by selecting “Ext.term.file” and define this separate file by “Sequencer filename”, parameter [↪ 15318](#).



How to read the table ...

- "2 IKD: 16 X DI/DO": two devices with 8 DI/DO each (2 x 8 = 16 DI/DO together) or one IKD-IN-16 (with 16 DIs) and one IKD-OUT-16 (with 16 DOs)
- "P": Phoenix
- "W": Wago
- "_": separator for combinations with different headers

For more details to **IKD-IN-16, IKD-OUT-16** refer to [↪ “4.7.4.2.1.2 IKD-IN-16, IKD-OUT-16 specifics”](#)

4 Configuration

4.7.4.2.1 Expansion Modules at CANopen Interface



For basic configuration see [↪ “6.3.11 Setup Expansion Modules at CAN 2”](#) - especially the flow charts of [↪ “Configuration process help”ff.](#)

Assignment of selectable Combinations CAN 2 (Node 1-6) used for DI/DO - Only Digital Inputs and Digital Outputs:

Combination selected by ...		Terminal assigned to ...					
Select external terminals ID 15320	# of terminals: I/O	1 st Node-ID ID 9930	2 nd Node-ID ID 9931	3 rd Node-ID ID 9932	4 th Node-ID ID 9933	5 th Node-ID ID 9934	6 th Node-ID ID 9935
DI/DO: Digital Inputs and Digital Outputs, only							
1IKD	1 IKD: 8 x DI/DO	IKD1 DI/DO 1-8					
2IKD	2 IKD: 16 x DI/DO	IKD1 DI/DO 1-8	IKD2 DI/DO 9-16				
3IKD	3 IKD: 24 x DI/DO	IKD1 DI/DO 1-8	IKD2 DI/DO 9-16	IKD3 DI/DO 17-24			
4IKD	4 IKD: 32 x DI/DO	IKD1 DI/DO 1-8	IKD2 DI/DO 9-16	IKD3 DI/DO 17-24	IKD4 DI/DO 25-32		
P16D	1 Phoenix: 16 x DI/DO			P16DIDO DI/DO 1-16			
W16D	1 WAGO: 16 x DI/DO			W16DIDO DI/DO 1-16			
P32D	1 Phoenix: 32 x DI/DO			P32DIDO DI/DO 1-32			
W32D	1 WAGO: 32 x DI/DO			W32DIDO DI/DO 1-32			
P16D_16D	2 Phoenix: 32 x DI/DO			P16DIDO DI/DO 1-16	P16DIDO DI/DO 17-32		

Assignment of selectable Combinations CAN 2 (Node 1-6) used for AI/AO - Only Analog Inputs and Analog Outputs:

Combination selected by ...		Terminal assigned to ...					
Select external terminals ID 15320	# of terminals: I/O	1 st Node-ID ID 9930	2 nd Node-ID ID 9931	3 rd Node-ID ID 9932	4 th Node-ID ID 9933	5 th Node-ID ID 9934	6 th Node-ID ID 9935
AI/AO: Analog Inputs and Analog Outputs, only							
P 16AI 4AO	1 Phoenix: 16 x AI / 4 x AO					P16AI4AO AI 1-16 AO 1-4	
W 16AI 4AO	1 WAGO: 16 x AI / 4 x AO					W16AI4AO AI 1-16 AO 1-4	

Assignment of selectable Combinations CAN 2 (Node 1-6) used for DI/DO/AI/AO:
Combinations of the expansion modules:

Combination selected by ...		Terminal assigned to ...					
Select external terminals ID 15320	# of terminals: I/O	1 st Node-ID ID 9930	2 nd Node-ID ID 9931	3 rd Node-ID ID 9932	4 th Node-ID ID 9933	5 th Node-ID ID 9934	6 th Node-ID ID 9935
DI/DO/AI/AO: Combinations of the expansion modules IKD and/or Phoenix							
1IKD_P 16AI 4AO	1 IKD: 8 x DI/DO 1 Phoenix: 16 x AI / 4 x AO	IKD1 DI/DO 1-8				P16AI4AO AI 1-16 AO 1-4	
2IKD_P 16AI 4AO	2 IKD: 16 x DI/DO 1 Phoenix: 16 x AI / 4 x AO	IKD1 DI/DO 1-8	IKD2 DI/DO 9-16			P16AI4AO AI 1-16 AO 1-4	
3IKD_P 16AI 4AO	3 IKD: 24 x DI/DO 1 Phoenix: 16 x AI / 4 x AO	IKD1 DI/DO 1-8	IKD2 DI/DO 9-16	IKD3 DI/DO 17-24		P16AI4AO AI 1-16 AO 1-4	
4IKD_P 16AI 4AO	4 IKD: 32 x DI/DO 1 Phoenix:	IKD1 DI/DO 1-8	IKD2 DI/DO 9-16	IKD3 DI/DO 17-24	IKD4 DI/DO 25-32	P16AI4AO AI 1-16 AO 1-4	

4 Configuration

4.7.4.2.1 Expansion Modules at CANopen Interface

Combination selected by ...		Terminal assigned to ...					
Select external terminals ID 15320	# of terminals: I/O	1 st Node-ID ID 9930	2 nd Node-ID ID 9931	3 rd Node-ID ID 9932	4 th Node-ID ID 9933	5 th Node-ID ID 9934	6 th Node-ID ID 9935
	16 x AI / 4 x AO						
P 16D_16AI 4AO	1 Phoenix: 16 x DI/DO 1 Phoenix: 16 x AI / 4 x AO			P16DIDO DI/DO 1-16		P16AI4AO AI 1-16 AO 1-4	
P 16D 16AI 4AO	1 Phoenix: 16 x DI/DO 16 x AI / 4 x AO					P16DIDO DI/DO 1-16 P16AI4AO AI 1-16 AO 1-4	
W 16D 16AI 4AO	1 WAGO: 16 x DI/DO 16 x AI / 4 x AO					W16DIDO DI/DO 1-16 W16AI4AO AI 1-16 AO 1-4	
P 32D 16AI 4AO	1 Phoenix,; 32 x DI/DO 16 x AI / 4 x AO					P32DIDO DI/DO 1-32 P16AI4AO AI 1-16 AO 1-4	
W 32D 16AI 4AO	1 WAGO,; 32 x DI/DO 16 x AI / 4 x AO					W32DIDO DI/DO 1-32 W16AI4AO AI 1-16 AO 1-4	
2P 16D_ 16AI 4AO	2 Phoenix: 32 x DI/DO 1 Phoenix: 16 x AI / 4 x AO			P16DIDO DI/DO 1-16	P16DIDO DI/DO 17-32	P16AI4AO AI 1-16 AO 1-4	
P32 D_16AI 4AO	1 Phoenix:			P32DIDO DI/DO 1-32		P16AI4AO AI 1-16	

Combination selected by ...		Terminal assigned to ...					
Select external terminals ID 15320	# of terminals: I/O	1 st Node-ID ID 9930	2 nd Node-ID ID 9931	3 rd Node-ID ID 9932	4 th Node-ID ID 9933	5 th Node-ID ID 9934	6 th Node-ID ID 9935
	32 x DI/DO 1 Phoenix: 16 x AI / 4 x AO					AO 1-4	
DI/DO/AI/AO: Combinations of the expansion modules IKD and/or WAGO							
W 16AI 4AO	1 Wago: 16 x AI / 4 x AO					W16AI4AO AI 1-16 AO 1-4	
1IKD_W 16AI 4AO	1 IKD: 8 x DI/DO 1 Wago: 16 x AI / 4 x AO	IKD1 DI/DO 1-8				W16AI4AO AI 1-16 AO 1-4	
2IKD_W 16AI 4AO	2 IKD: 16 x DI/DO 1 Wago: 16 x AI / 4 x AO	IKD1 DI/DO 1-8	IKD2 DI/DO 9-16			W16AI4AO AI 1-16 AO 1-4	
3IKD_W 16AI 4AO	3 IKD: 24 x DI/DO 1 Wago: 16 x AI / 4 x AO	IKD1 DI/DO 1-8	IKD2 DI/DO 9-16	IKD3 DI/DO 17-24		W16AI4AO AI 1-16 AO 1-4	
4IKD_W 16AI 4AO	4 IKD: 32 x DI/DO 1 Wago: 16 x AI / 4 x AO	IKD1 DI/DO 1-8	IKD2 DI/DO 9-16	IKD3 DI/DO 17-24	IKD4 DI/DO 25-32	W16AI4AO AI 1-16 AO 1-4	



If you need only four analog inputs, select “P16AI4AO” and configure only four inputs to ON at the configuration for the external analog inputs.

CANopen Settings and Procedure



Proceed as follows to configure an external device:

- Connect external device(s)
- **Check that WAGO devices are configured to default.**

This is the case if the WAGO CAN-Coupler is new or if there was any change in number or kind of WAGO modules.

- Configure and check parameters at the easYgen (Select external terminals, Node-ID, DI/DOs, AI/AOs)

Reboot the device that the setting (15320) becomes effective

- If WAGO terminals are connected and the configuration of the external AIs and/or AOs is done, the easYgen must send a configuration string to the WAGO coupler one time. This can be done by setting parameter »Configure external devices«  15134 to "YES". This must be repeated if there is any change in number or kind of WAGO modules.
- If you have changed parameter »Select external terminals «  15320: **reboot the device**
- Set parameter »Configure external devices«  15134 to "Yes"
- Verify the successful configuration of the external device(s)



Update WAGO After Any Change!

The update procedure described above must be repeated if there is any change in number or kind of Wago modules.

ID	Parameter	CL	Setting range [Default]	Description
9940	This device	2	Node-ID 1-126 [Node-ID 7]	The Node-ID for the control unit (this device) is configured here.
9930	1st Node-ID	2	Node-ID 1-126 [Node-ID 1]	This Node-ID's are used for the communication with CANopen devices. Parameter  15320 "Select external terminals" offers often used pre-settings and the possibility to point to a file containing customer specific settings.
9931	2nd Node-ID	2	Node-ID 1-126 [Node-ID 2]	
9932	3rd Node-ID	2	Node-ID 1-126 [Node-ID 3]	
9933	4th Node-ID	2	Node-ID 1-126 [Node-ID 4]	
9934	5th Node-ID	2	Node-ID 1-126 [Node-ID 5]	
9935	6th Node-ID	2	Node-ID 1-126 [Node-ID 6]	

ID	Parameter	CL	Setting range [Default]	Description
15320	Select external terminals	2		Notes A change of this parameter becomes only effective if the device is rebooted! and: the external devices itself must be configured with the correct node ID .
			[Off]	No external CANopen device is supported on CAN2
			Ext. term file	File defined with parameter ↩ 15318 is active.
			1IKD	Selection of the combination of terminal(s) at the six pre-set Node-IDs. For terminal description see table ↩ Table above.
			2IKD	
			3IKD	
			4IKD	
			P16D	
			P32D	
			P16D_16D	
			P16AI4AO	
			1IKD_P16AI4AO	
			2IKD_P16AI4AO	
			3IKD_P16AI4AO	
			4IKD_P16AI4AO	
			P16D_16AI4AO	
			P16D16AI4AO	
			P32D16AI4AO	
			2P16D_16AI4AO	
			P32D_16AI4AO	
			W16AI4AO	
			1IKD_W16AI4AO	
			2IKD_W16AI4AO	
3IKD_W16AI4AO				
4IKD_W16AI4AO				
W16D				
W32D				
W16D16AI4AO				
W32D16AI4AO				
15318	Sequencer filename	2	[Filename.seq]	Filename of a special additional file to define external devices (see NOTE ↩ Chapter 4.7.4.2.1).

ID	Parameter	CL	Setting range [Default]	Description
				<p>Notes</p> <p>This parameter takes only effect if parameter ↪ 15320 is configured to "Ext.term.file".</p> <p>Please ask your Woodward partner for support / an offer.</p>
15134	Configure external devices	2	Yes [No]	<p>This parameter starts the configuration of external Phoenix expansion boards.</p> <p>Notes</p> <p>This parameter can only be used to configure Phoenix or Wago expansion boards as describe above.</p> <p>Refer to the IKD 1 Manual 37135 for configuring the IKD 1 expansion boards.</p>

Changing the Node ID

Changing the Node ID of a Wago terminal which is still configured:

- Set the new NODE-ID via DIP switches
- Load default values (via a temporary change in number or kind of Wago modules-run configuration again.

4.7.4.2.1.1 Configurable Wago devices

If configurable WAGO devices are used, the mode of the terminal must be configured via the PC software WAGO I/O Check. These configuration cannot be done via the easYgen parameters. Be aware that the easYgen parameters for the corresponding channels must be consistent with the Wago configuration done with the WAGO I/O Check.

RTD device (750-451)

To use the 8 channel RTD device (750-451) the following process image must be configured via the Wago I/O-Check.



The following types are not supported: Ni1000 (high resolution), Ni1000 (TK5000), Pt1000 (EN 60751 high resolution), and 1200 Ohm.

Typ	Expected format
Pt100 (EN 60751)	default
Ni100 (EN 60751)	default
Pt500 (EN 60751)	default
Pt200 (EN 60751)	default
Ni1000 (TK6180, DN 43760)	default

Typ	Expected format
Ni120 (Minco)	default
5000 Ohm	S5-FB250

Thermocouple device (750-458) for voltage measurement

There is no intuitive setting in the easYgen-XT if a channel of the Thermocouple (TC) device (750-458) is configured for voltage measurement. But nevertheless it is possible.

Therefore a special scaling of the easYgen-XT parameters “Sender value at display min.” and “Sender value at display max” is required like described in the table below:

Voltage measuring range	“Sender value at display min.”	“Sender value at display max.”
+/- 30 mV	-614.4	614.4
+/- 60 mV	-307.2	307.2
+/- 120 mV	-153.6	153.6

4.7.4.2.1.2 IKD-IN-16, IKD-OUT-16 specifics

It is possible to use IKD-IN-16 and IKD-OUT-16 in combination with IKD, Phoenix, Wago and easYgen or only IKD-IN-16 or IKD-OUT-16 with easYgen.

From the configuration in easYgen, the differences between the IKDs and IKD-IN-16 / IKD-OUT-16 are the following:

- IKD has 8 digital inputs and 8 digital outputs
- IKD-IN-16 has 16 digital inputs and **no** digital outputs
- IKD-OUT-16 has 16 digital outputs and **no** digital inputs

For this reason, if DOs and DIs are required, at least one IKD-IN-16 and one IKD-OUT-16 must be connected.

The configuration on the IKD-IN-16 and IKD-OUT-16 (channels 1-16 or 17-32 and baudrate) can be done by Dip switches at these devices. Refer to the corresponding manuals.

Possible combinations IKD-IN-16, IKD-OUT-16 with IKD

If **only up to 16** channels are required, it is possible to use either:

- only one or two IKDs (set parameter  15320 Select external terminals = 1IKD or 2IKD)
- only one IKD-IN-16 (set parameter 15320 = 2IKD)
- only one IKD-OUT-16 (setparameter 15320 = 2IKD)
- only one IKD-IN-16 and one IKD-OUT-16 (set parameter 15320 = 2IKD)

If **more than 16** channels are required, only IKDs or only IKD-IN-16 and/or IKD-OUT-16 may be used within channels 1-16 and channels 17-32 respectively.

It is not possible to mix IKDs and IKD-IN-16/IKD-OUT-16 within the channels 1-16 or 17-32.

Examples for possible combinations:

- Parameter “ 15320 Select external terminals” is configured to a value with “**3IKD**”:
 - channels 1-24: three IKD or
 - channels 1-16: one IKD-IN-16, one IKD-OUT-16; channels 17-24 :one IKD or
 - channels 1-16: one IKD-IN-16, channels 17-24 :one IKD or
 - channels 1-16: one IKD-OUT-16; channels 17-24 :one IKD or
 - channels 1-16: one IKD-IN-16 and one IKD-OUT-16; channels 17-24 :one IKD

For example it is **not possible** to use one IKD for channel 1-8 and IKD-IN-16 and/or IKD-OUT-16 for channels 9-24.

- Parameter “ 15320 Select external terminals” is configured to a value with “**4IKD**”:
 - channels 1-32: four IKD or
 - channels 1-32: two IKD-IN-16, two IKD-OUT-16 or
 - channels 1-32: two IKD-IN-16 or
 - channels 1-32: two IKD-OUT-16 or
 - channels 1-16: one IKD-IN-16, one IKD-OUT-16; channels 17-32 :two IKD or
 - channels 1-16: one IKD-IN-16, channels 17-32 :two IKD or
 - channels 1-16: one IKD-OUT-16; channels 17-32 :two IKD or
 - channels 1-16: two IKD; channels 17-32: one IKD-IN-16, one IKD-OUT-16 or
 - channels 1-16: two IKD; channels 17-32: one IKD-IN-16 or
 - channels 1-16: two IKD; channels 17-32: one IKD-OUT-16

For example it is **not possible** to use one IKD for channel 1-8 and IKD-IN-16 and/or IKD-OUT-16 for channels 9-24 and one IKD for channels 25-32.

Combinations of IKD-IN-16, IKD-OUT-16 with Phoenix or Wago analog input or analog output terminals.

It is possible too to combine the above mentioned example combinations of IKD, IKD-IN-16 and IKD-OUT-16 with additional Phoenix or Wago analog input or analog output terminals.

The configuration for these possible combinations is done in the same way as with the IKD using the appropriate prefix "2IKD_" or "4_IKD_".

Examples:

- one IKD-IN-16 and one IKD-OUT-16 and a Phoenix terminal with up to 16 analog inputs and up to 4 analog outputs are connected. Set easYgen parameter “15320 Select external terminals” to "2IKD_P16AI4AO". ("2IKD_" because IKD-IN-16 and IKD-OUT-16 support 16 channels.)

- two IKD-IN-16 and one (or two) IKD-OUT-16 and a Wago terminal with up to 16 analog inputs and up to 4 analog outputs are connected. Set easYgen parameter "15320 Select external terminals" to "4IKD_W16AI4AO". ("2IKD_" because IKD-IN-16 and IKD-OUT-16 support 16 channels.)

4.7.4.2.2 J1939 Interface

General notes



For additional information refer to [↗](#) "7.5 J1939 Protocol".

Parameter 15102 »Device type« allows to select an ECU either by name or - for even more flexibility - via an ECU file; then the name of the preferred ECU file must be entered into parameter 15167 »ECU file name«. Please ask your local Woodward partner for further information.

ID	Parameter	CL	Setting range [Default]	Description
15166	J1939	2	Off	The J1939 interface is disabled. No messages will be received or transmitted.
			[On]	The J1939 interface is enabled. The J1939 interface of this device may be operated with different engine control units or analog input devices. J1939 values (e.g. from an ECU) can be received and indicated
15102	Device type	2		<p>The J1939 interface of this device may be operated with different engine control units or analog input devices.</p> <p>This parameter determines the type of the used ECU or that a special ECU file designed for an ECU which is not listed here shall be used.</p> <p>Notes</p> <p>A change of this parameter takes only fully effect after reboot ↗ 10419 the device!</p>

ID	Parameter	CL	Setting range [Default]	Description
			ECU file	This is to support ECUs which are not represented by the selection. Enter file name with parameter 15167 »ECU file name« below.
			[Standard] Standard C	<p>Standard J1939 coupling is enabled: J1939 data is displayed according to the SAE J1939 standard.</p> <p>This setting must be configured for all J1939 ECUs, which cannot be selected here (e.g. Deutz (EMR3 & EMR4), John Deere, Daimler, Perkins, Iveco, Caterpillar, Liebherr, etc.).</p> <p>"Standard C" is like "Standard" but with counter and checksum at TSC1.</p> <p>Please refer to ↪ "7.5 J1939 Protocol" for details and/or ask your local Woodward partner for an offer.</p>
			S6 Scania	The Scania EMS/S6 ECU is enabled: J1939 data according to the SAE J1939 standard and some S6-specific data are considered.
			S8 Scania	The Scania S8 ECU is enabled: J1939 data according to the SAE J1939 standard and some S8-specific data are considered.
			EMR2 Deutz	The Deutz EMR2 ECU is enabled: J1939 data according to the SAE J1939 standard and some EMR2-specific data are considered.

ID	Parameter	CL	Setting range [Default]	Description
				This setting is also recommended for Volvo EDC4.
			EMS2 Volvo	<p>The Volvo EMS2 ECU is enabled: J1939 data according to the SAE J1939 standard and some EMS2-specific data are considered.</p> <p>This setting is also recommended for Volvo EDC3 and EMS1.</p>
			ADEC ECU7 MTU	The MTU ADEC ECU7 with SAM is enabled: J1939 data according to the SAE J1939 standard and some ADEC-specific data are considered.
			EGS Woodward	The Woodward EGS, ECU, E3-series, E6-series or PG+ are enabled: J1939 data according to the SAE J1939 standard and some EGS/E3/E6-specific data are considered.
			MFR/EDC7 MAN	The MAN MFR/EDC7 ECU is enabled: J1939 data according to the SAE J1939 standard and some EDC-specific data are considered.
			EEM SISU	The SISU EEM2/3 ECU is enabled: J1939 data according to the SAE J1939 standard and some EEM2/3-specific data are considered.
			Cummins	<p>The Cummins ECU is enabled: J1939 data according to the SAE J1939 standard and some Cummins-specific data are considered.</p> <p>This setting is also recommended for Cummins CM570 and CM850.</p>

ID	Parameter	CL	Setting range [Default]	Description
				<p>Notes</p> <p>Some Cummins setups need a special value for "Governor Gain" otherwise they will shut down. In this cases please set the "Governor Gain" of the ECU to »Internal« instead of »J1939«.</p> <p>ADEC ECU8/ECU9 MTU</p> <p>The MTU ADEC ECU8 with SmartConnect or the MTU ADEC ECU9 is enabled: J1939 data according to the SAE J1939 standard and some ADEC-specific data are considered.</p> <p>HATZ EDC17</p> <p>The BOSCH ECU HATZ EDC17 is enabled.</p> <p>If "VGA (Preglow)" is active, then LogicsManager Variable 03.17 becomes TRUE; if "Maintenance" becomes activ, then LogicsManager Variable 03.18 becomes TRUE.</p> <p>FPT MD1</p> <p>FPT MD1 ECU is enabled. J1939 data according to the SAE J1939 standard and some FPT MD1 specific data are considered.</p>
15167	ECU file name	2	[ECU file]	<p>If »Device type« ID15102 is »ECU file«, the easYgen can communicate with further ECUs. The correct file name with extension must be typed in and this xxx.ecu file must be available "inside" the easYgen (flashed).</p> <p>Notes</p> <p>Please contact your local Woodward partner to enable communication with your ECU (xxx.ecu file and ECU specific settings).</p>

ID	Parameter	CL	Setting range [Default]	Description
10454	Set addresses by Device type	2	Yes [No]	If this parameter was set to "Yes", 15106 "J1939 own address" and 15107 "Engine control address" were set according the typical values for the selection of "Device type".
15106	J1939 own address	2	0 to 255 [234]	<p>The easYgen sends J1939 request and control messages with this source address. It must be changed for different ECU types according to the following table. The ECU listens only to control messages, if they are sent to the correct address.</p> <p>Note: Changing parameter "10454 Set addresses by Device type" to "yes" sets the parameter according listing below. However, it can also be set manually.</p> <ul style="list-style-type: none"> • Standard, Standard C: 0 • S6/S8 Scania: 39 • EMR2 Deutz: 3 • EMS2 Volvo: 17 • ADEC ECU7 MTU: 1 • EGS Woodward: 234 • MFR/EDC7 MAN: 253 • EEM SISU: 234 • Cummins: 220 • ADEC ECU8/ECU9 MTU: 234 • Hatz EDC17: 3 • FPT MD1: 33 • Standard: Please refer to ↗ "7.5 J1939 Protocol" and to the manual of your J1939 ECU manufacturer. <p>Details may be found in the manual of the genset control and in ↗ "7.5 J1939 Protocol".</p>

ID	Parameter	CL	Setting range [Default]	Description
15107	Engine control address	2	0 to 255 [0]	<p>Configures the address of the J1939 device, which is controlled. The easYgen sends J1939 request and control messages with this destination address.</p> <p>Note: Changing parameter "10454 Set addresses by Device type" to "yes" sets the parameter according listing below. However, it can also be set manually.</p> <ul style="list-style-type: none"> • Standard, Standard C: 234 • S6/S8 Scania: 0 • EMR2 Deutz: 0 • EMS2 Volvo: 0 • ADEC ECU7 MTU: 128 • EGS Woodward: 0 • MFR/EDC7 MAN: 39 • EEM SISU: 0 • Cummins: 0 • ADEC ECU8/ECU9 MTU: 0 • Hatz EDC17: 0 • FPT MD1: 0 • Standard: Please refer to ↗ "7.5 J1939 Protocol" and to the manual of your J1939 ECU manufacturer. <p>Details may be found in the manual of the genset control and in ↗ "7.5 J1939 Protocol".</p>
15108	Reset previous act. DTCs - DM3	2	Yes [No]	<p>If this parameter is set to "Yes", a DM3 message "Acknowledge passive faults" is sent. After that this parameter is reset automatically to "No".</p> <p>As a result the alarms DTCs (Diagnostic Trouble Codes) of (DM2) which no longer apply are cleared.</p>

ID	Parameter	CL	Setting range [Default]	Description
15133	Reset act. DTCs - DM11	2	Yes [No]	<p>If this parameter is set to "Yes", a DM11 message "Acknowledge active faults" is sent. After that this parameter is reset automatically to "No".</p> <p>As a result the alarms DTCs (Diagnostic Trouble Codes) of (DM1) which no longer apply are cleared.</p>
15103	SPN version	2	Version 1 / Version 2 / Version 3 [Version 1]	<p>The J1939 protocol provides 4 different versions for the conversion method of the Suspect Parameter Number (SPN). This is important for a correct interpretation of the alarm messages (DM1 & DM2).</p> <p>This parameter defines the version of the conversion method: Version 1, Version 2 or Version 3. Version 4 is detected automatically.</p> <p>For details please refer to the manual of your J1939 ECU manufacturer.</p>
15127	ECU remote controlled	2	On	The unit sends J1939 control messages to the ECU. Depending on the selected device type (parameter ↔ 15102), contains a specific selection of commands.
			[Off]	The ECU remote control via the J1939 protocol will be disabled.
				<p>Notes</p> <p>The unit sends J1939 control messages to the ECU. Depending on the selected device type (parameter ↔ 15102), it contains a specific selection of commands. Available messages are</p>

ID	Parameter	CL	Setting range [Default]	Description
				<p>speed deviation and droop for ECUs as well as engine start/stop, enable idle mode, rated speed switch and preglow for some ECUs.</p> <p>Refer to ↪ “7.5 J1939 Protocol” for more detailed information.</p>
5537	Speed deviation ECU	2	0 to 1,400 rpm [120 rpm]	<p>This parameter adjusts the range of the speed deviation around the rated speed, which is sent to the ECU.</p> <p>It relates to the engine rated speed (parameter ↪ 1601).</p> <p>There are two methods of sending the speed setpoint to the ECU: With a speed offset and a speed setpoint. The frequency and power control must be configured to "PID".</p> <p>Speed offset</p> <p>(S6/S8 Scania, EMS2 Volvo, EGS Woodward, Cummins)</p> <p>The easYgen sends a speed offset with a range of 0 to 100% (every 20 ms). 50% = rated speed.</p> <p>There is also an internal speed offset configured in the ECU, this parameter determines what corresponds with 0% or 100%. If there is a positive and a negative speed offset, they should be symmetrical in the ECU.</p> <p>We recommend to have the same speed offset configured in the ECU and in this parameter here. A different setting will result in an additional "controller gain".</p>

ID	Parameter	CL	Setting range [Default]	Description
				<p>How to test this parameter during commissioning:</p> <p>Islanded operation</p> <p>Disable the frequency controller and change parameter ↩ 5508 for the initial state between 0 and 100%, the engine should change the speed as follows:</p> <ul style="list-style-type: none"> • 0 = rated speed - negative speed offset from ECU • 50 = rated speed • 100 = rated speed + positive speed offset from ECU <p>Mains parallel operation</p> <p>Check with the setpoint in the display if the engine is able to deliver the full power.</p>
				<p>Speed setpoint</p> <p>(EMR2 Deutz, ADEC MTU, EGS Woodward, EEM SISU, Standard)</p> <p>The easYgen sends a speed setpoint in rpm (every 10 ms) that varies around the rated speed in the range of +/- the speed deviation.</p> <p>How to test this parameter during commissioning:</p> <p>Islanded operation</p> <p>Disable the frequency controller and change parameter ↩ 5508 for the initial state between 0 and 100%, the engine should change the speed as follows:</p>

ID	Parameter	CL	Setting range [Default]	Description
				<ul style="list-style-type: none"> • 0 = rated speed - speed deviation ECU e.g.: 1,500 - 120 = 1,380 rpm • 50 = rated speed e.g.: = 1,500 rpm • 100 = rated speed + speed deviation ECU e.g.: 1,500 + 120 = 1,620 rpm <p>Mains parallel operation</p> <p>Check with the setpoint in the display if the engine is able to deliver the full power.</p> <p>Keep this value as small as possible, i.e. do not enter a speed deviation of 500, if the engine varies only between 1,400 and 1,600 rpm.</p> <p>Notes</p> <p>The Woodward EGS ECU supports both types of speed deviation control and may be configured either to "Speed offset" or "Speed setpoint".</p> <p>In mains parallel operation, the EGS can be configured to receive a real power setpoint from the easYgen to control the power. In this case, real power control must be disabled in the easYgen.</p> <p>This parameter is only visible if ECU remote controlled (parameter 15127 ) is configured to "On".</p>

ID	Parameter	CL	Setting range [Default]	Description
4843	ECU Application	2	[Continuous]	Prepared for MTU - 3B mode
			Emergency	Prepared for MTU - 3D mode
				<p>Notes</p> <p>For details please refer to the manual of your J1939 ECU manufacturer.</p> <p>This parameter is only visible if "Device type" (parameter ↩ 15102) is configured to "ADEC ECU8 MTU" and "ECU remote controlled" (parameter ↩ 15127) is configured to "On".</p>
12939	ECU Power Mode	2	[Low power mode]	Prepared for MTU - Low mode
			High power mode	Prepared for MTU - High mode
				<p>Notes</p> <p>For details please refer to the manual of your J1939 ECU manufacturer.</p> <p>This parameter is only visible if "Device type" (parameter ↩ 15102) is configured to "ADEC ECU8 MTU" and "ECU remote controlled" (parameter ↩ 15127) is configured to "On".</p>
15164	ECU seq. B_IN_1	2	Determined by LogicsManager 86.31 [(0 & 1) & 1] = 11647	<p>This LogicsManager is prepared to pass binary information to the ECU. Right now it is only used for:</p> <p>ADEC ECU 9 "Rapid Engine Start" (SPN 3542)</p> <p>If the easYgen is transmitting a start command and the result of</p>

ID	Parameter	CL	Setting range [Default]	Description
				<p>"86.31 LM: ECU seq. B_IN_1" is:</p> <p>False, the ECU9 will start with "Normal Engine Start"</p> <p>True, the ECU9 will start with "Rapid Engine Start"</p> <p>EMS2 Volvo "Override" (Engine restored operation)</p> <p>If the result of "86.31 LM: ECU seq. B_IN_1" is:</p> <p>False: The Volvo override flag is only active if LM "04.27 Critical mode"</p> <p>True: The Volvo override flag is active independent of LM "04.27 Critical mode"</p> <p>S8 Scania "Desorption Granted Status" (of ADC Aftertreatment Desorption Control)</p> <p>If the result of "86.31 LM: ECU seq. B_IN_1" is:</p> <p>False: "No action required"</p> <p>True: "Increased idle with heavy exhaust braking"</p> <p>For details refer to Scania S8 documentation.</p> <p>FPT MD1</p> <p>If the result of "86.31 LM: ECU seq. B_IN_1" is:</p> <p>False: "not in Safe condition"</p> <p>True: "in Safe condition"</p> <p>For details refer to FPT documentation VCM2ECM message .</p> <p>Notes</p>

ID	Parameter	CL	Setting range [Default]	Description
				For information on the LogicsManager and its default settings see ↩➤ "9.3.1 LogicsManager Overview".
15165	ECU seq. B_IN_2	2	Determined by LogicsManager 86.32 [(0 & 1) & 1] = 11648	<p>This LogicsManager is prepared to pass binary information to the ECU. Right now it is only used for:</p> <p>EMS2 Volvo "Disable fuel"</p> <p>If the result of "86.32 LM: ECU seq. B_IN_2" is:</p> <p>False: Command "Disable fuel" is not active.</p> <p>True: Command "Disable fuel" is active.</p> <p>Notes</p> <p>For information on the LogicsManager and its default settings see ↩➤ "9.3.1 LogicsManager Overview".</p>
7863	DPF: Inhibit regeneration	2	Determined by LogicsManager 86.48 [(0 & 1) & 1] = 11779	<p>If this LogicsManager is TRUE, SPN 3695 "DPF Regeneration Inhibit Switch" is transmitted as active.</p> <p>For information on the LogicsManager and its default settings see ↩➤ "9.3.1 LogicsManager Overview".</p>
7864	DPF: Force regeneration	2	Determined by LogicsManager 86.49 [(0 & 1) & 1] = 11780	<p>If this LogicsManager is TRUE, SPN 3696 "DPF Regeneration Force Switch" is transmitted as active.</p> <p>For information on the LogicsManager and its default settings see ↩➤ "9.3.1 LogicsManager Overview".</p>

ID	Parameter	CL	Setting range [Default]	Description
15162	AM ECU seq.A_IN_1	2	Determined by AnalogManager 81.22 [A1 = 10.01 ZERO]	<p>This LogicsManager is prepared to pass binary information to the ECU. Right now, it is not used.</p> <p>mtu ECU9 “Alternate Droop Accelerator 1 Select”</p> <p>If the result of AM 81.22 is:</p> <ul style="list-style-type: none"> -0, the ECU9 is running with “Normal droop” -has a value 1 - 13, the ECU9 is running with an alternative droop - is > 13 or negative, the ECU9 is running with “Normal droop” <p>Please be aware that the values assigned to this function must be whole-numbers. If not, the decimals will be cut.</p> <p>Notes</p> <p>Refer to ↳ “4.9.1 Operations” for explanation how to use the AnalogManager.</p> <p>Refer to ↳ “9.4.2 Data Sources AM” for a list of all data sources.</p>
15163	AM ECU seq.A_IN_2	2	Determined by AnalogManager 81.23 [A1 = 10.01 ZERO]	<p>This AnalogManager is prepared to pass analog information to the ECU via J1939.</p> <p>If this AnalogManager is used by an ECU its function will be described in the manual of the corresponding J1939 ECU. For more information please see J1939 ECU description.</p> <p>Notes</p>

ID	Parameter	CL	Setting range [Default]	Description
				<p>Refer to 4.9.1 Operations for explanation how to use the AnalogManager.</p> <p>Refer to 9.4.2 Data Sources AM for a list of all data sources.</p>

4.7.4.3 CAN Interface 3

General notes



The CAN bus is a field bus and subject to various disturbances. Therefore, it cannot be guaranteed that every request will be answered. We recommend to repeat a request, which is not answered within reasonable time.

COB-ID of SYNC/TIME messages



Parameters [9104](#) and [9105](#) use synchronization and time messages that adhere to the following structure.

Note: If CAN 3 is configured as "Time consumer", the unit consumes time message **only** from CAN 3.

Bit number	Value	Meaning
31 (MSB)	0	Unit does not consume TIME message
	1	Unit consumes TIME message
30	0	Unit does not generate SYNC/TIME message
	1	Unit generates SYNC/TIME message
29	X	N/A
28-11	0	Always 0
10-0 (LSB)	X	Bits 10-0 of SYNC/TIME COB-ID

TIME synchronization message

CANopen master	COB-ID TIME	Time consumer	Time transmitted
Off	Bit 31 = 0; Bit 30 = 0	No	No
	Bit 31 = 0; Bit 30 = 1	No	Yes
	Bit 31 = 1; Bit 30 = 0	Yes	No
	Bit 31 = 1; Bit 30 = 1	Yes	Yes

CANopen master	COB-ID TIME	Time consumer	Time transmitted
Default Master	Bit 31 = 0; Bit 30 = 0	No	No
	Bit 31 = 0; Bit 30 = 1	No	Yes ¹
	Bit 31 = 1; Bit 30 = 0	Yes	No
	Bit 31 = 1; Bit 30 = 1	Yes	Yes ¹
On	Bit 31 = 0; Bit 30 = 0	No	No
	Bit 31 = 0; Bit 30 = 1	No	Yes
	Bit 31 = 1; Bit 30 = 0	Yes	No
	Bit 31 = 1; Bit 30 = 1	Yes	Yes



¹ If CANopen master (lowest Node-ID).

ID	Parameter	CL	Setting range [Default]	Description
3143	Baudrate	2	20 kBd / 50 kBd / 100 kBd / 125 kBd / 250 kBd / 500 kBd / 800 kBd / 1000 kBd [250 kBd]	This parameter defines the used baud rate. Please note, that all participants on the CAN bus must use the same baud rate.
1895	Align device no. with Node-ID	2	No [Yes]	<p>If this parameter is configured to "Yes" the parameter »Node-ID CAN bus 3« 8952 will be overwritten with the value of the »Device number « 1702 and is not visible.</p> <p>If configured to "No", parameter »Device number « 1702 is visible and will not be overwritten.</p> <p>Notes</p> <p>This is to avoid CAN ID conflict in multi unit systems if using the same ID more than one time. This can cause CAN "Bus-Off" failure.</p>
8952	Node-ID CAN bus 3	2	1 to 127 (dec) [1]	<p>A number that is unique to the control must be set in this parameter so that this control unit can be correctly identified on the CAN bus.</p> <p>This address number may only be used once on the CAN bus. All additional addresses are calculated based on this unique device number.</p> <p>Notes</p> <p>We recommend to configure the Node-IDs for units, which participate in load sharing, as low</p>

ID	Parameter	CL	Setting range [Default]	Description
				as possible to facilitate establishing of communication. For multiple genset applications please make sure to change parameter ↩ 1702 as well
8995	CANopen Master	2		One bus participant must take over the network management and put the other participants into "operational" mode. The easYgen is able to perform this task.
			[Default Master]	The unit starts up in "operational" mode and sends a "Start_Remote_node" message after a short delay (the delay is the Node-ID (parameter ↩ 8952) in seconds, i.e. if the Node-ID is configured to 2, the message will be sent after 2 seconds). If more than one easYgen is configured to Default Master, the unit with the lower Node-ID will take over control. Therefore, the CAN bus devices, which are intended to act as Default Master should be assigned a low Node-ID. No other device on the CAN bus (except the easYgens) may operate as Master).
			On	The unit is the CANopen Master and automatically changes into operational mode and transmits data.
			Off	The unit is a CANopen Slave. An external Master must change into operational mode.
				Notes If this parameter is configured to "Off", the Master controller (for example a PLC) must send a "Start_Remote_node" message to initiate the load share message transmission of the easYgen. If no "Start_Remote_node" message would be sent, the complete system would not be operational.
8953	Producer heartbeat time	2	0 to 65500 ms [2000 ms]	Independent from the CANopen Master configuration, the unit transmits a heartbeat message with this configured heartbeat cycle time. If the producer heartbeat time is equal 0, the heartbeat will only be sent as response to a remote frame request. The time configured here will be rounded up to the next 20 ms step.
8967	COB-ID SYNC Message	2	0 to FFFFFFFF hex [80 hex]	This parameter defines whether the unit generates the SYNC message or not.

4 Configuration

4.7.4.3.1 Receive PDO {x} (Process Data Object)

ID	Parameter	CL	Setting range [Default]	Description
				Complies with CANopen specification: object 1005, subindex 0; defines the COB-ID of the synchronization object (SYNC).
				Notes The structure of this object is shown in ↗ "COB-ID of SYNC/TIME messages"
8968	Producer SYNC Message time	2	0 to 65000 ms [20 ms]	This is the cycle time of the SYNC message. If the unit is configured for this function it will send the SYNC message with this interval. The time configured here will be rounded up to the next 10 ms step.
9104	COB-ID TIME Message	2	1 to FFFFFFFF hex [C0000100 hex]	This parameter defines whether the unit generates the TIME message or not. Complies with CANopen specification: object 1012, subindex 0; defines the COB-ID of the time object (TIME).
				Notes The structure of this object is shown in ↗ "COB-ID of SYNC/TIME messages"
9105	Cycle of TIME sync. message	2	1.0 to 6500.0 s [10.0 s]	This is the cycle time of the TIME message. If the unit is configured for this function (parameter ↗ 9104) it will send the TIME message with this interval.
				Notes The structure of this object is shown in ↗ "TIME synchronization message"
9127	Password protection	5	Off	Password protection for CAN 3 is not active . Notes Take care for a protected access!
			[On]	Password protection for CAN 3 is active.

4.7.4.3.1 Receive PDO {x} (Process Data Object)

General notes

RPDO mapping is carried out as shown in ([↗](#) Fig. 234).

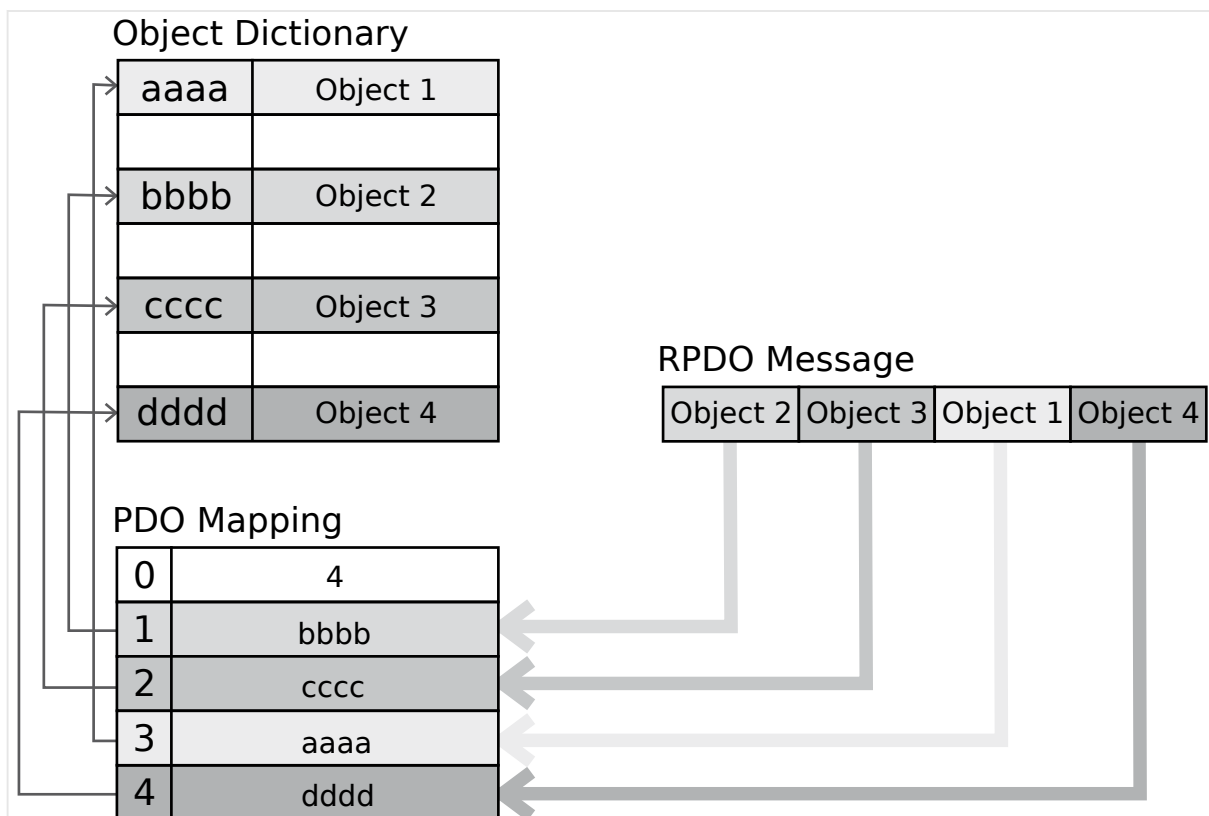

Fig. 234: RPDO mapping principle

COB-ID parameters



Parameters [↪ 12741](#)/[↪ 12751](#)/[↪ 12761](#)/[↪ 12771](#)/[↪ 12781](#) use communication parameters that adhere to the following structure.

RPDO Objects can be remote signals (parameter 503; please refer to [↪](#) “Remote control word 1” for details), DI states and AI measured values.

UNSIGNED 32		MSB				LSB
Bits	Bits	31	30	29	28-11	10-0
11 bit ID	11 bit ID	0/1	X	X	0	11 bit identifier

Bit number	Value	Meaning
31 (MSB)	0	PDO exists / is valid
	1	PDO does not exist / is not valid
30	X	N/A
29	X	N/A
28-11	0	Always 0
10-0 (LSB)	X	Bits 10-0 of COB-ID



PDO valid / not valid allows to select, which PDOs are used in the operational state.

ID	Parameter	CL	Setting range [Default]	Description
12741 12751 12761 12771 12781	COB-ID	2	1 to FFFFFFFF hex [8000000 hex]	<p>This parameter contains the communication parameters for the PDOs, the device is able to receive.</p> <p>Complies with CANopen specification: object 1400 hex (for RPDO 1, 1401 hex for RPDO 2, 1402 hex for RPDO 3, 1403 hex for RPDO 4, and 1404 hex for RPDO 5), subindex 1.</p>
			<p>Notes</p> <p>The structure of this object is shown in ↗ "COB-ID parameters".</p> <p>Do not configure an RPDO or TPDO with a COB-ID higher than 580 hex or lower than 180 hex. These IDs are reserved for internal purposes.</p>	
12742 12752 12762 12772 12782	Event timer	2	0 to 65535 ms [2000 ms]	<p>This parameter configures the time, from which this PDO is marked as "not existing". The time configured here will be rounded up to the next 5 ms step. Received messages are processed by the control unit every 20 ms. Messages, which are sent faster, will be discarded. We recommend to configure ten times the cycle time of the received data here.</p>
			<p>Notes</p> <p>Complies with CANopen specification: object 1400 (for RPDO 1, 1401 hex for RPDO 2, 1402 hex for RPDO 3, 1403 hex for RPDO 4, and 1404 hex for RPDO 5), subindex 5</p>	
12743 12753 12763 12773 12783	Selected Data Protocol	2	0 to 65535 [0]	<p>A data protocol may be selected by entering the data protocol ID here. If 0 is configured here, the message assembled by the mapping parameters is used. If an unknown data protocol ID is configured here, a failure is indicated by the CAN status bits. Possible data protocol IDs are:</p>
			65000	IKD 1 - external DIs/DOs 1 through 8
			65001	IKD 1 - external DIs/DOs 9 through 16

ID	Parameter	CL	Setting range [Default]	Description
			65002	IKD 1 - external DIs/DOs 17 through 24
			65003	IKD 1 - external DIs/DOs 25 through 32
12744 12754 12764 12774 12784	Number of Mapped Objects	2	0 to 4 [0]	<p>This parameter defines the number of valid entries within the mapping record. This number is also the number of the application variables, which shall be received with the corresponding PDO.</p> <p>Notes</p> <p>Complies with CANopen specification: object 1600 hex (for RPDO 1, 1601 hex for RPDO 2, 1602 hex for RPDO 3, 1603 hex for RPDO 4, and 1604 hex for RPDO 5), subindex 0</p>
12745 12755 12765 12775 12785	1. Mapped Object	2	0 to 65535 [0]	<p>This parameter contains the information about the mapped application variables. These entries describe the PDO contents by their index. The sub-index is always 1. The length is determined automatically.</p> <p>Notes</p> <p>Complies with CANopen specification: object 1600 hex (for RPDO 1, 1601 hex for RPDO 2, 1602 hex for RPDO 3, 1603 hex for RPDO 4, and 1604 hex for RPDO 5), subindex 1.</p>
12746 12756 12766 12776 12786	2. Mapped Object	2	0 to 65535 [0]	<p>This parameter contains the information about the mapped application variables. These entries describe the PDO contents by their index. The sub-index is always 1. The length is determined automatically.</p> <p>Notes</p> <p>Complies with CANopen specification: object 1600 hex (for RPDO 1, 1601 hex for RPDO 2, 1602 hex for RPDO 3, 1603 hex for RPDO 4, and 1604 hex for RPDO 5), subindex 2.</p>
12747 12757 12767 12777 12787	3. Mapped Object	2	0 to 65535 [0]	<p>This parameter contains the information about the mapped application variables. These entries describe the PDO contents by their index. The sub-index is always 1. The length is determined automatically.</p> <p>Notes</p> <p>Complies with CANopen specification: object 1600 hex (for RPDO 1, 1601 hex for RPDO 2, 1602 hex for RPDO 3, 1603 hex for</p>

4 Configuration

4.7.4.3.2 Transmit PDO {x} (Process Data Object)

ID	Parameter	CL	Setting range [Default]	Description
				RPDO 4, and 1604 hex for RPDO 5), subindex 3.
12748	4. Mapped Object	2	0 to 65535 [0]	This parameter contains the information about the mapped application variables. These entries describe the PDO contents by their index. The sub-index is always 1. The length is determined automatically.
12758				
12768				
12778				
12788			Notes Complies with CANopen specification: object 1600 hex (for RPDO 1, 1601 hex for RPDO 2, 1602 hex for RPDO 3, 1603 hex for RPDO 4, and 1604 hex for RPDO 5), subindex 4.	

4.7.4.3.2 Transmit PDO {x} (Process Data Object)

General notes

TPDO mapping is carried out as shown in (↳ Fig. 235).

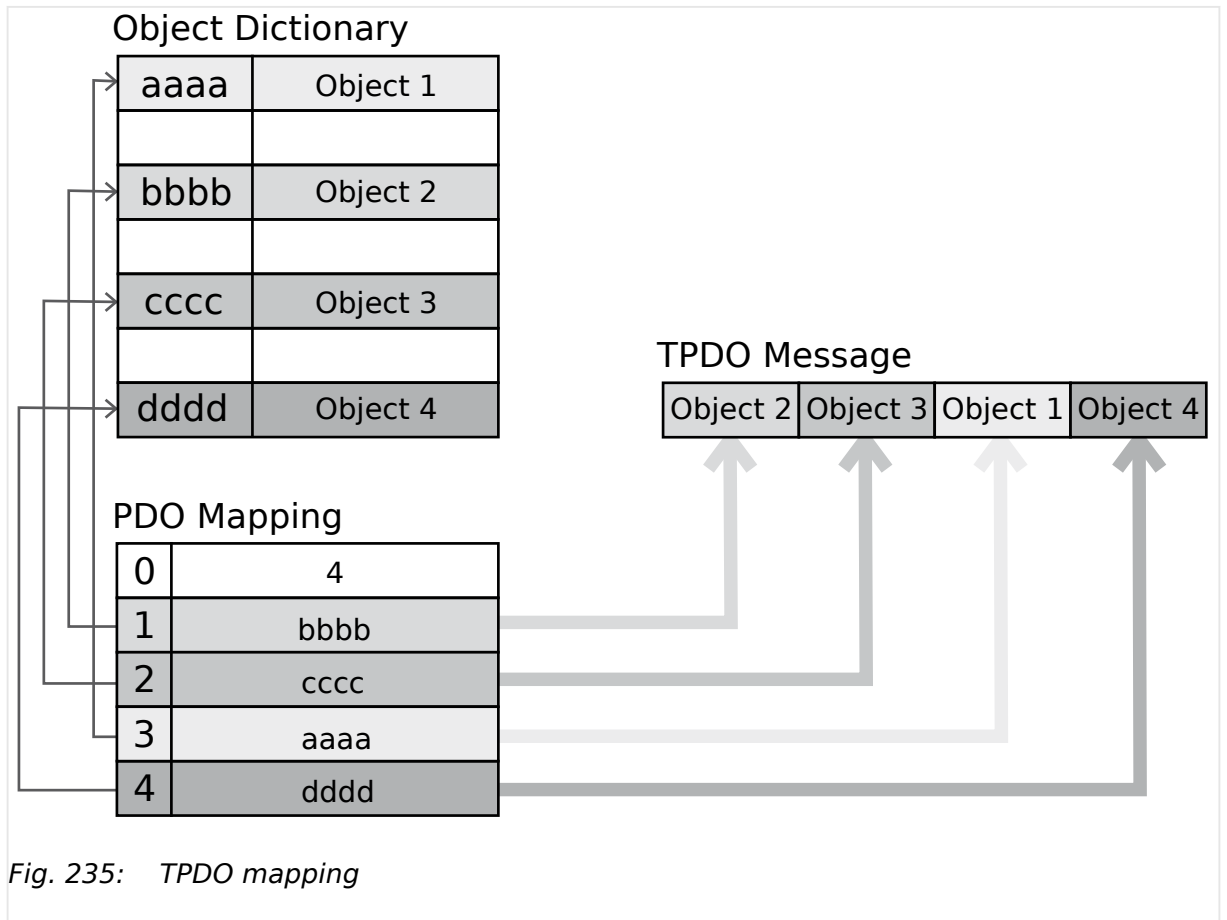

Fig. 235: TPDO mapping



CANopen allows to send 8 byte of data with each Transmit PDO. These may be defined separately if no pre-defined data protocol is used.

All data protocol parameters with a parameter ID may be sent as an object with a CANopen Transmit PDO.

The data length will be taken from the data byte column (see [↪](#) “9.2 Data Protocols”):

- 1,2 UNSIGNED16 or SIGNED16
- 3,4 UNSIGNED16 or SIGNED16
- 5,6 UNSIGNED16 or SIGNED16
- 1,2,3,4 UNSIGNED32 or SIGNED32
- 3,4,5,6 UNSIGNED32 or SIGNED32
- etc.

The object ID is identical with the parameter ID when configuring via front panel or ToolKit.

COB-ID parameters



Parameters [↪](#) 12691/[↪](#) 12701/[↪](#) 12711/[↪](#) 12721/[↪](#) 12731 use communication parameters that adhere to the following structure.

UNSIGNED 32		MSB				LSB
Bits	Bits	31	30	29	28-11	10-0
11 bit ID	11 bit ID	0/1	X	X	0	11 bit identifier

Bit number	Value	Meaning
31 (MSB)	0	PDO exists / is valid
	1	PDO does not exist / is not valid
30	X	N/A
29	X	N/A
28-11	0	Always 0
10-0 (LSB)	X	Bits 10-0 of COB-ID



PDO valid / not valid allows to select, which PDOs are used in the operational state.

Transmission types

 Parameters [↩ 12693](#)/[↩ 12703](#)/[↩ 12713](#)/[↩ 12723](#)/[↩ 12733](#) are used to select one of the following transmission types.

Transmission type	PDO transmission				
	Cyclic	Acyclic	Synchronous	Asynchronous	RTR only
0	Will not be sent				
1-240	X		X		
241-251	Will not be sent				
252	Will not be sent				
253	Will not be sent				
254				X	
255				X	

 A value between 1 and 240 means that the PDO is transferred synchronously and cyclically. The transmission type indicating the number of SYNC, which are necessary to trigger PDO transmissions.

Receive PDOs are always triggered by the following SYNC upon reception of data independent of the transmission types 0 to 240. For TPDOs, transmission type 254 and 255 means, the application event is the event timer.

ID	Parameter	CL	Setting range [Default]	Description
12691	COB-ID	2	1 to FFFFFFFF hex [80000000 hex]	This parameter contains the communication parameters for the PDOs the unit is able to transmit. The unit transmits data (i.e. visualization data) on the CAN ID configured here.
12701				Complies with CANopen specification: object 1800 hex for (TPDO 1, 1801 hex for TPDO 2, 1802 hex for TPDO 3, 1803 hex for TPDO 4, and 1804 hex for TPDO 5), subindex 1.
12711				Notes The structure of this object is shown in ↩ "COB-ID parameters" Do not configure an RPDO or TPDO with a COB-ID higher than 580 hex or lower than 180 hex. These IDs are reserved for internal purposes. In case a LSG is part of CAN 1, do not configure COB-IDs 181 - 18E
12721				
12731				

ID	Parameter	CL	Setting range [Default]	Description
				hex because legacy devices are using same IDs but cannot be switched.
12693 12703 12713 12723 12733	Transmission type	2	0 to 255 [255]	<p>This parameter contains the communication parameters for the PDOs the unit is able to transmit. It defines whether the unit broadcasts all data automatically (value 254 or 255) or only upon request with the configured address of the COB-ID SYNC message (parameter ↩➤ 9100).</p> <p>Notes</p> <p>Complies with CANopen specification: object 1800 hex (for TPDO 1, 1801 hex for TPDO 2, 1802 hex for TPDO 3, 1803 hex for TPDO 4, and 1804 hex for TPDO 5), subindex 2.</p> <p>The description of the transmission type is shown in ↩➤ "Transmission types".</p>
12694 12704 12714 12724 12734	Event timer	2	0 to 65535 ms [20 ms]	<p>This parameter contains the communication parameters for the PDOs the unit is able to transmit. The broadcast cycle for the transmitted data is configured here. The time configured here will be rounded up to the next 5 ms step.</p> <p>Notes</p> <p>Complies with CANopen specification: object 1800 hex (for TPDO 1, 1801 hex for TPDO 2, 1802 hex for TPDO 3, 1803 hex for TPDO 4, and 1804 hex for TPDO 5), subindex 5</p>
12692 12702 12712 12722 12732	Selected Data Protocol	2	0 to 65535 8962: [5003] 8963: [5008] 8964: [0] 8965: [0] 8966: [0]	<p>A data protocol may be selected by entering the data protocol ID here. If 0 is configured here, the message assembled by the mapping parameters is used. If an unknown data protocol ID is configured here, a failure is indicated by the CAN status bits.</p> <p>Possible data protocol IDs are:</p>
			65000	IKD 1 - external DIs/DOs 1 through 8
			65001	IKD 1 - external DIs/DOs 9 through 16
			65002	IKD 1 - external DIs/DOs 17 through 24
			65003	IKD 1 - external DIs/DOs 25 through 32

4 Configuration

4.7.4.3.2 Transmit PDO {x} (Process Data Object)

ID	Parameter	CL	Setting range [Default]	Description
			5003	Data telegram (CAN and MODBUS)
			5005	Data telegram (CAN mains values)
			5010	Data telegram (MODBUS)
			5011	Data telegram (CAN alarm values)
12695 12705 12715 12725 12735	Number of Mapped Objects	2	0 to 4 [0]	This parameter contains the mapping for the PDOs the unit is able to transmit. This number is also the number of the application variables, which shall be transmitted with the corresponding PDO.
				Notes Complies with CANopen specification: object 1A00 hex (for TPDO 1, 1A01 hex for TPDO 2, 1A02 hex for TPDO 3, 1A03 hex for TPDO 4, and 1A04 hex for TPDO 5), subindex 0
12696 12706 12716 12726 12736	1. Mapped Object	2	0 to 65535 [0]	This parameter contains the information about the mapped application variables. These entries describe the PDO contents by their index. The sub-index is always 1. The length is determined automatically.
				Notes Complies with CANopen specification: object 1A00 hex (for TPDO 1, 1A01 hex for TPDO 2, 1A02 hex for TPDO 3, 1A03 hex for TPDO 4, and 1A04 hex for TPDO 5), subindex 1
12697 12707 12717 12727 12737	2. Mapped Object	2	0 to 65535 [0]	This parameter contains the information about the mapped application variables. These entries describe the PDO contents by their index. The sub-index is always 1. The length is determined automatically.
				Notes Complies with CANopen specification: object 1A00 hex (for TPDO 1, 1A01 hex for TPDO 2, 1A02 hex for TPDO 3, 1A03 hex for TPDO 4, and 1A04 hex for TPDO 5), subindex 2
12698 12708 12718 12728 12738	3. Mapped Object	2	0 to 65535 [0]	This parameter contains the information about the mapped application variables. These entries describe the PDO contents by their index. The sub-index is always 1. The length is determined automatically.
				Notes

ID	Parameter	CL	Setting range [Default]	Description
				Complies with CANopen specification: object 1A00 hex (for TPDO 1, 1A01 hex for TPDO 2, 1A02 hex for TPDO 3, 1A03 hex for TPDO 4, and 1A04 hex for TPDO 5), subindex 3
12699 12709 12719 12729 12739	4. Mapped Object	2	0 to 65535 [0]	This parameter contains the information about the mapped application variables. These entries describe the PDO contents by their index. The sub-index is always 1. The length is determined automatically.
			Notes Complies with CANopen specification: object 1A00 hex (for TPDO 1, 1A01 hex for TPDO 2, 1A02 hex for TPDO 3, 1A03 hex for TPDO 4, and 1A04 hex for TPDO 5), subindex 4	

4.7.4.4 CAN Load Share Parameters

ID	Parameter	CL	Setting range [Default]	Description
9921	Transfer rate LS fast message (CAN)	2	0.10 to 0.30 s [0.10 s]	The transfer rate defines the time delay between two fast CAN messages. In case of CAN systems with a high bus load (e.g. long distance between the units with low baud rate), a shorter transfer rate (higher time setting) helps to reduce the bus load.
9999	Load share timeout factor	2	2 to 20 [2]	"Transfer rate LS fast message" multiplied by "Load share timeout factor" defines the loadshare timeout. If a loadshare message was not received within this defined time a event will be shown in the Event History. See also ↪ "7.7 Load Sharing"
9920	Load share CAN-ID	2	2xx Hex / 3xx Hex / 4xx Hex / 5xx Hex [5xx Hex]	The first digit of the CAN ID or the range (i.e. 2xx Hex means 200 through 2FF hex) is configured here. The last two digits will be assigned by the control with the settings from the device number (parameter ↪ 1702).

4.7.5 Ethernet Interfaces

General notes

The Ethernet network provides a fast communication capability to different devices, like remote panel, PLC or SCADA systems. The common protocol Modbus TCP is there for the preferred communication protocol. Additionally the Ethernet connection supports the Woodward protocol Servlink for ToolKit and other Woodward own monitoring tools (like remote panel and SCADA visualization tool). At least the easYgen provides a UDP protocol for system relevant and time discrete information exchange.



Do not connect the easYgen with the internet as long the security aspects are not considered. Consider an IP responsible person to discuss proper security procedures like placing routers and fire walls.

If the easYgen (or -system) shall be connected to an already existing Ethernet network, a network responsible person must arrange and allocate the IP Addresses. He takes care about IP-Address, the subnet mask, and when needed the gateway IP Address.



The main settings of the Ethernet load share communication are:

- Parameter 7488 "Transmission rate" determines in 80ms steps (80, 160, 240, 320, 400) the refresh rate of the load share UDP message. (It has no impact on the Ethernet Interconnectivity function. These UDP messages refresh times are defined by the InterconnectMapper PC Tool.)
- Parameter 7489 "Timeout cycles" determines after how much missing UDP messages a timeout shall be indicated as "Unit not recognized" and entered as flag in the LogicsManager (08.78, 08.79, 08.80). (For event entry refer to parameter "Load share timeout event" [↪ 2442.](#))
- Parameter 7497 "Timeout cycles data" determines after how much **additionally** missing UDP messages from the timeout on (see item before) data shall be declared as invalid and the missing member alarm shall be initiated. Invalid data means finally the partner is lost and its data will be cleared.

ID	Parameter	CL	Setting range [Default]	Description
7488	Transmission rate	2	[80 ms] 80 to 400 ms	The transmission rate defines the refresh rate (time) of the UDP load share and control messages. The entry is done in 80ms steps (80, 160, 240, 320, 400). Note: This setting must be the same in all members.
7489	Timeout cycles	2	[5] 2 to 30	The device monitors the UDP messages it receives. Here you can set how many UDP messages may be lost one after the other from a taught-in partner before this participant is marked with "Unit not recognized". The timeout time is calculated as follows: "Timeout cycles" (ID7489) multiplied with "Transmission rate" (ID 7488). Note: This setting must be the same in all members.
7497	Timeout cycles data	2	[12] 0 to 30	The device monitors the received UDP messages and invalidates the data from lost members. If a taught-in participant is marked as not recognized, you can set here how many more UDP messages may be lost consecutively from this partner before his data is declared invalid.

ID	Parameter	CL	Setting range [Default]	Description
				With declaring the data of any taught-in member invalid, the alarm "Missing member" will be issued. The resulting timeout time for declaring data as invalid is calculated as follows: "[Timeout cycles" (ID 7489) + "Timeout cycles data"(ID 7497)] multiplied with "Transmission rate"(ID 7488). Note: This setting must be the same in all members.
7485	Modbus/TCP Slave ID	2	[1] 1 to 255	Your local Modbus device address, which is used to identify the device via Modbus/TCP (Ethernet), must be entered here.
9129	Password protection	5	Off	Password protection for Ethernet is not active .
			[On]	Notes Take care for a protected access! Password protection for Ethernet is active.

4.7.5.1 General notes "Network address"

A network address is basically calculated of an IP address and a subnet mask. The network address is the result of a binary AND connection of the IP address and the subnet mask:

Example network address calculation		
	decimal	binary
IP address	192.168.002.001	11000000 10101000 00000010 00000001
Subnet mask	255.255.255.224	11111111 11111111 11111111 11100000
Network address = IP address AND Subnet mask	192.168.002.000	11000000 10101000 00000010 00000000

The device (host) part is the individual part of the network address for a dedicated device. The device part is the result of the binary AND connection of the IP address and the inverted subnet mask:

Example device part (host) calculation		
	decimal	binary
IP address	192.168.002.001	11000000 10101000 00000010 00000001
Subnet mask	255.255.255.224	11111111 11111111 11111111 11100000
Subnet mask inverted		00000000 00000000 00000000 00011111
Device part = IP address AND Subnet mask inverted	000.000.000.001	00000000 00000000 00000000 00000001



Note: Because the device has 3 Ethernet ports (A , B and C) it is important to make sure that the network addresses of all ports are different!

**Note:** Network address check

There is a plausibility check between Ethernet A, B and C to ensure that all three networks uses different network addresses. The plausibility check uses the actual network address (IP address with the related subnet mask) for the compare.

In case that not all ethernet ports uses different networks the alarm "Eth. configuration" and the LM flag "08.54 Eth. configuration" are active.

**Note:** IP address range 224.0.0.0 to 239.255.255.255

This address range is restricted for specific use (multicast class D addresses) and not usable for the Ethernet IP configuration from network A, B and C.

Bad example (there is a conflict between Ethernet A and Ethernet B because of the same resulting network address)

- Ethernet A:

IP address: 192.168.074.070

Subnet mask: 255.255.255.000

Resulting network address: 192.168.074.000

- Ethernet B:

IP address: 192.168.074.071

Subnet mask: 255.255.255.000

Resulting network address: 192.168.074.000

- Ethernet C:

IP address: 192.168.073.071

Subnet mask: 255.255.255.000

Resulting network address: 192.168.073.000

Good example (there is no conflict between Ethernet A, B and C because all have different network address)

- Ethernet A:

IP address: 192.168.075.070

Subnet mask: 255.255.255.000

Resulting network address: 192.168.075.000

- Ethernet B:

IP address: 192.168.074.071

Subnet mask: 255.255.255.000

Resulting network address: 192.168.074.000

- Ethernet C:

IP address: 192.168.073.071

Subnet mask: 255.255.255.000

Resulting network address: 192.168.073.000

4.7.5.2 Ethernet Network A

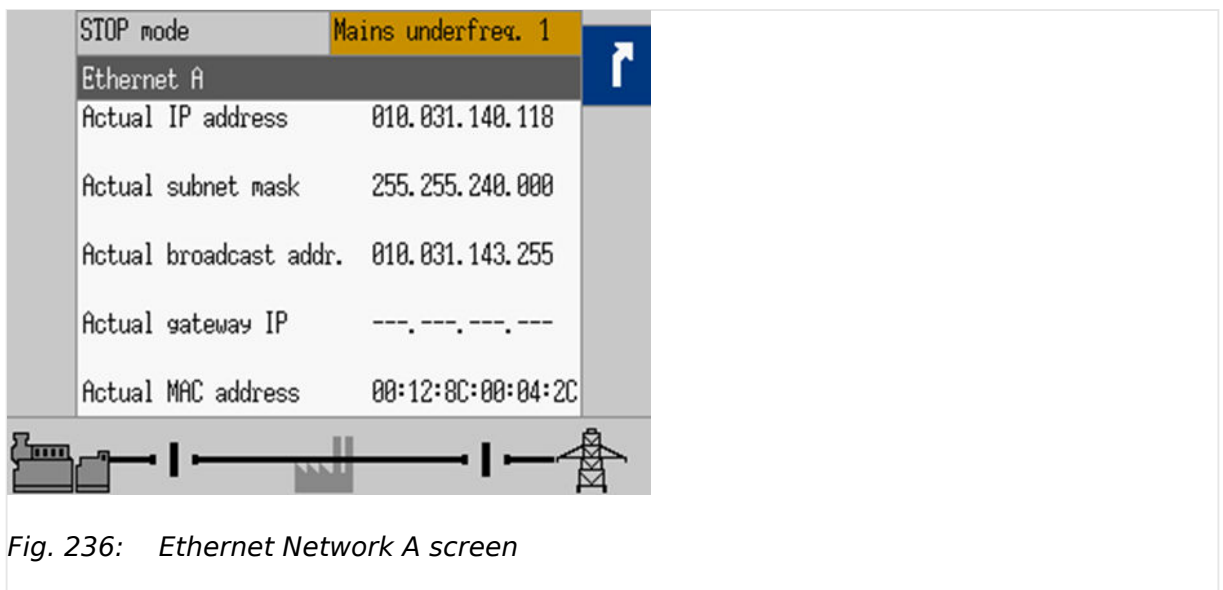

Fig. 236: Ethernet Network A screen

The actual IP address, subnet mask, gateway IP address (all hex values) can be viewed under Next Page (Status Menu) / Diagnostic / Interfaces / Ethernet / Ethernet A.

IP address

Each port within the Ethernet network must have its own network address. As long the Ethernet network is only used by the easYgen-XT system, the address range is free configurable. For better troubleshooting use the default Ethernet address range and configure the single IP addresses according to their device numbers.



Device part: Restrictions

The "device part" is the logical result of »IP Address« AND NOT »Network Mask«. The bits (dual system $0_2/1_2$) of the device part must be different from being all the same - neither all zero 0_2 nor all 1_2 (broadcast).

Please select your IP address accordingly.

Gateway IP address

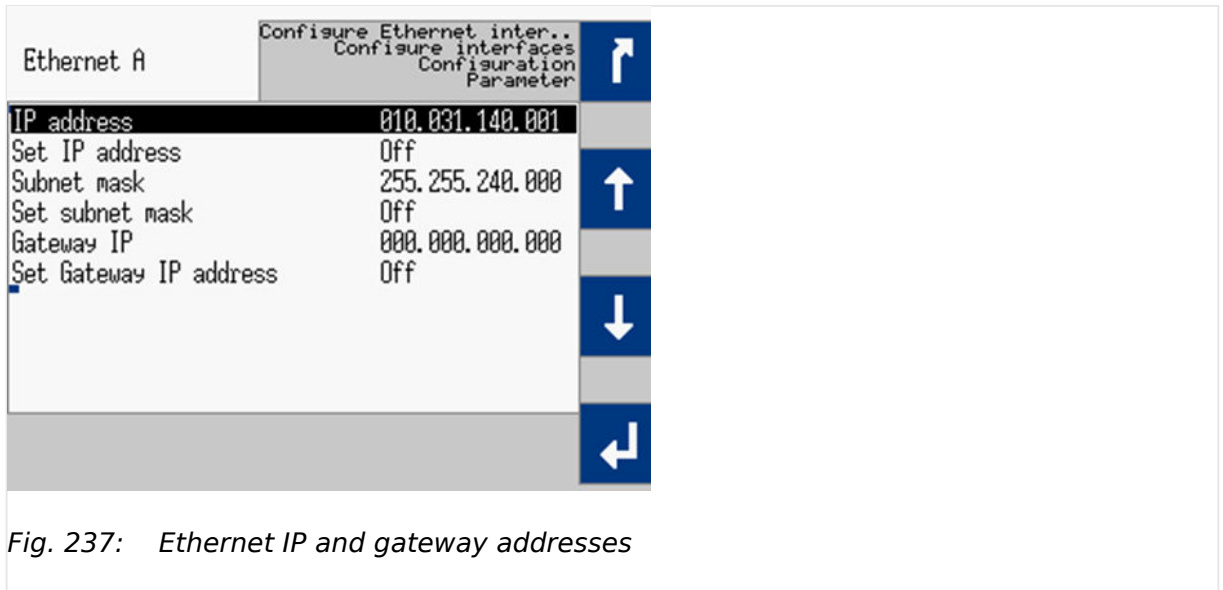

Fig. 237: Ethernet IP and gateway addresses

The gateway IP address defines a node within a local area network (LAN), which is directed to external networks. It is usually not needed in an easYgen Ethernet network. Refer to your network responsible contact person, if a gateway capability is required.



HEX values

The addresses and subnet masks are known as hex values but are displayed in HMI and ToolKit as decimal values.

ID	Parameter	CL	Setting range [Default]	Description
5330	IP address	2	[10, 31, 140, 0]	Field 1,2,3,4 for IP address Ethernet port A. This setting will be not valid automatically. The »Set IP address« parameter must be set to »ON« for enabling.
5331				Notes Device part bits are not allowed to be either all 00...₂ or all 11...₂ (broadcast).
5332				
5333				
7412	Set IP address	2	Off	Set IP-Address Ethernet port A.
5334	Subnet mask	2	[255, 255, 240, 0]	Set byte 1,2,3,4 of the subnet mask Ethernet port A. This setting will be not valid automatically. The »Set subnet mask« parameter must be set to »ON« for enabling.
5335				
5336				
5337				
7413	Set subnet mask	2	Off	Set subnet mask Ethernet port A.
5338	Gateway IP	2	[0, 0, 0, 0]	Field 1,2,3,4 for gateway IP-Address for Ethernet port A. This setting will be not valid automatically. The »Set IP address« parameter must be set to »ON« for enabling. If 0.0.0.0 is set, the gateway's functionality is switched off.
5339				
5340				
5341				

ID	Parameter	CL	Setting range [Default]	Description
5342	Set Gateway IP address	2	Off	Set Gateway IP Address for Ethernet port A

4.7.5.3 Ethernet Network B

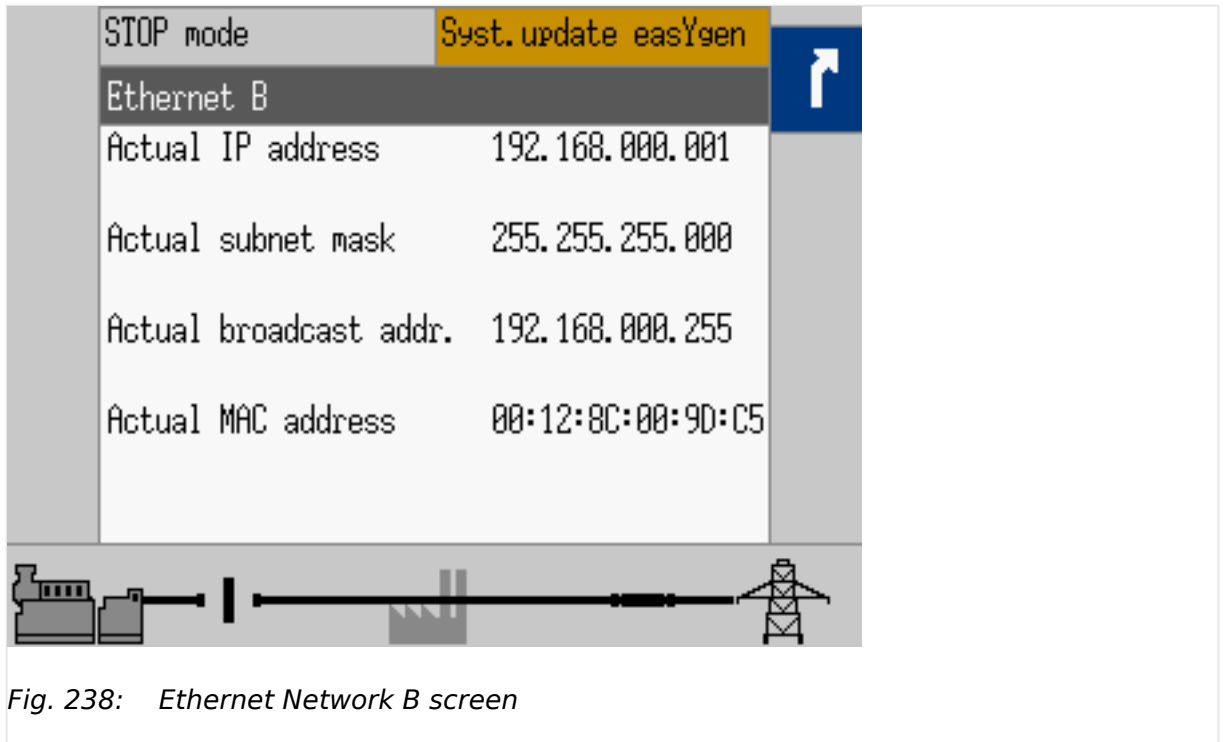

Fig. 238: Ethernet Network B screen

The actual IP address and subnet mask (all hex values) can be viewed under Next Page (Status Menu) / Diagnostic / Interfaces / Ethernet / Ethernet B.

IP address

Each port within the Ethernet network must have its own network address. As long the Ethernet network is only used by the easYgen-XT system, the address range is free configurable. For better troubleshooting use the default Ethernet address range and configure the single IP addresses according to their device numbers.



Device part: Restrictions

The "device part" is the logical result of »IP Address« AND NOT »Network Mask«. The bits (dual system $0_2/1_2$) of the device part must be different from being all the same - neither all zero 0_2 nor all 1_2 (broadcast).

Please select your IP address accordingly.



HEX values

The addresses and subnet masks are known as hex values but are displayed in HMI and ToolKit as decimal values.

ID	Parameter	CL	Setting range [Default]	Description
5430	IP address	2	[10, 31, 140, 0]	Field 1,2,3,4 for IP address Ethernet port B. This setting will be not valid automatically. The »Set IP address« parameter must be set to »ON« for enabling.
5431				Notes Device part bits are not allowed to be either all 00...2 or all 11...2 (broadcast).
5432				
5433				
7414	Set IP address	2	Off	Set IP-Address Ethernet port B.
5434	Subnet mask	2	[255, 255, 240, 0]	Set byte 1,2,3,4 of the subnet mask Ethernet port B. This setting will be not valid automatically. The »Set subnet mask« parameter must be set to »ON« for enabling.
5435				
5436				
5437				
7415	Set subnet mask	2	Off	Set subnet mask Ethernet port B.

4.7.5.4 Ethernet Network C

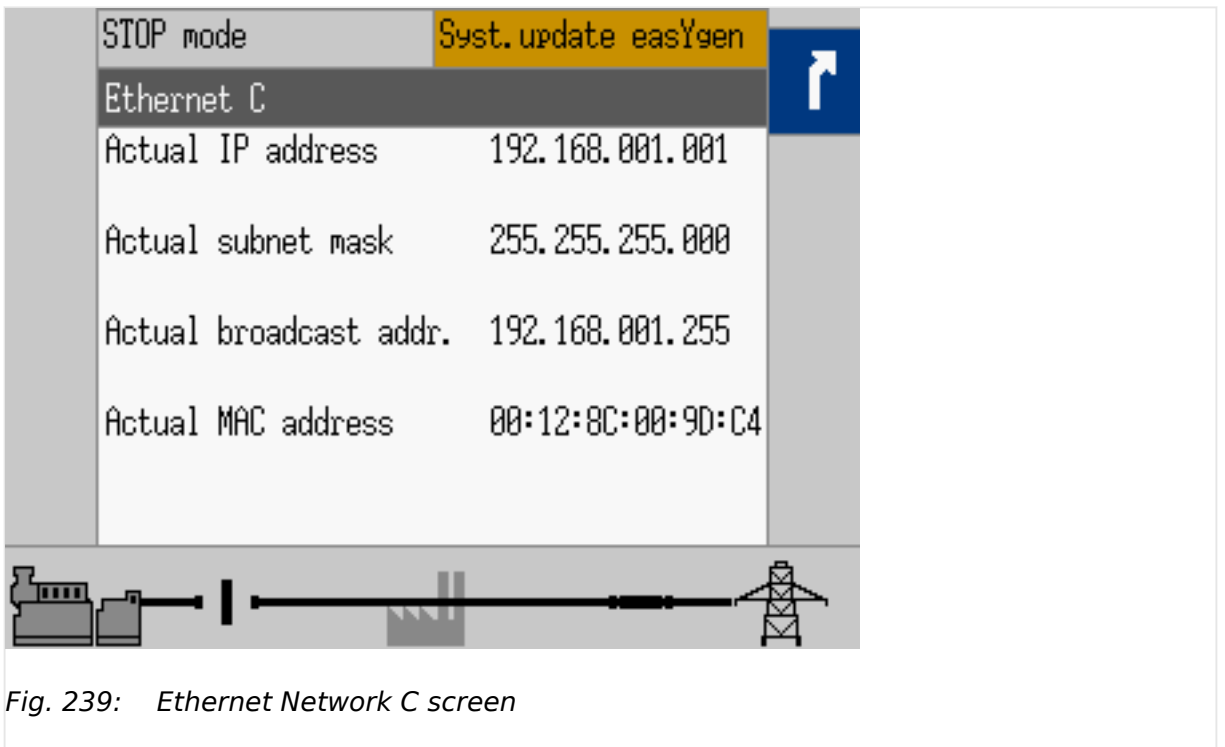

Fig. 239: Ethernet Network C screen

The actual IP address and subnet mask (all hex values) can be viewed under Next Page (Status Menu) / Diagnostic / Interfaces / Ethernet / Ethernet C.

IP address

Each port within the Ethernet network must have its own network address. As long the Ethernet network is only used by the easYgen-XT system, the address range is free configurable. For better troubleshooting use the default Ethernet address range and configure the single IP addresses according to their device numbers.



Device part: Restrictions

The "device part" is the logical result of »IP Address« AND NOT »Network Mask«. The bits (dual system $0_2/1_2$) of the device part must be different from being all the same - neither all zero 0_2 nor all 1_2 (broadcast).

Please select your IP address accordingly.



HEX values

The addresses and subnet masks are known as hex values but are displayed in HMI and ToolKit as decimal values.

ID	Parameter	CL	Setting range [Default]	Description
7418	IP address	2	[10, 31, 140, 0]	Field 1,2,3,4 for IP address Ethernet port C. This setting will be not valid automatically. The »Set IP address« parameter must be set to »ON« for enabling.
7419				Notes Device part bits are not allowed to be either all $00..._2$ or all $11..._2$ (broadcast).
7420				
7421				
7416	Set IP address	2	Off	Set IP-Address Ethernet port C.
7422	Subnet mask	2	[255, 255, 240, 0]	Set byte 1,2,3,4 of the subnet mask Ethernet port C. This setting will be not valid automatically. The »Set subnet mask« parameter must be set to »ON« for enabling.
7423				
7424				
7425				
7417	Set subnet mask	2	Off	Set subnet mask Ethernet port C.

4.7.5.5 SNTP

SNTP feature

The Simple Network Time Protocol (SNTP) is a common procedure to synchronize clocks in computer systems via packaged based communication networks. In this manner, the easYgen-XT can be configured as a SNTP client. The easYgen-XT is also usable as a SNTP server within the local area network by its own IP address.

The SNTP functionality can be configured for three modes:

- **External SNTP mode**

The easYgen-XT requests time and date information from an external SNTP server, marked with an own IP address.

- **Load sharing mode**

The easYgen-XT requests time and date information from the easYgen with the smallest device number, if the load sharing over Ethernet is enabled.

- **Internal clock mode**

The SNTP client mechanism is disabled. The own real time clock determines clock and date.



HEX values

The addresses and subnet masks are known as hex values but are displayed in HMI and ToolKit as decimal values.

ID	Parameter	CL	Setting range [Default]	Description
7780 7781 7782 7783	SNTP address	2	0 to 255 (4x) [10, 14, 128, 128]	Set byte 1,2,3,4 of the IP address of the external SNTP-Server.
7784	Rate	2	60 to 6000 s [1200 s]	Set the time rate of the SNTP-Server request. Note: After changing this value, the previous rate must expire before the new rate is used.
7785	Timeout	2	30 to 600 s [60 s]	Set the timeout of the SNTP-Server. This feature is prepared for the future and has currently no influence on the function.
7786	Mode	2	[Internal clock] External SNTP Load sharing	The device provides different SNTP modes. Internal clock: The clock information comes from the internal clock. The SNTP function is disabled. External SNTP: The clock information is receipt by an external SNTP-Server. Load sharing: The clock information is generated within the easYgen system. A master (usually the device with the smallest device number) serves all easYgens with time and date information according to their request rate.

4.7.5.6 Ethernet Interconnectivity

General notes

The easYgen offers the possibility to send and receive data via the Ethernet communication bus independent on load share and control messages. Therefore the customer can configure with the PC Tool InterConnectMapper textual control files to be placed in the according easYgens. In the simplest application there is placed a sent control file into the sending easYgen and a receive control file into the receiving easYgen. The protocol for sending this data contains individually created UDP messages and is independent of the load share protocol.

The data pool for this feature are LogicsManager Command variables, AnalogManager variables, data addressed by indices and constants. The refresh rate of these UDP messages is configurable.

The interconnectivity function can be provided with redundancy as long the Ethernet B/C bus is taken as communication medium.

Up to 127 devices can be in one system. Each device can be configured to send an own send telegram. Each device can be configured to listen to up to 126 other devices.

The full send telegram of each device can have up to 246 bytes data.

For typical use cases for this type of communication refer to [↪](#) “6.2.3 Ethernet Interconnectivity”.



In future other devices like LS6XT and GC3000XT will be equipped with this feature too, so that the interconnectivity can be expanded into larger breaker control systems.

Configuration



Woodward offers a PC software named InterconnectMapper Tool to configure the Interconnectivity Function.

The InterconnectMapper is a PC Tool to configure a device to send freely definable UDP telegrams with freely mapped data on it and also to configure devices to listen to these telegrams and extract data from it. The InterConnectMapper software can be installed separately from other Woodward software. Please check proper licensing procedures with your Woodward service.

For more information, please refer to application chapter [↪](#) “6.2.3 Ethernet Interconnectivity”.

The InterconnectMapper PC software includes a Help file for more details.

ID	Parameter	CL	Setting range [Default]	Description
7487	Interconnectivity	2	[Off]	The Interconnectivity function is disabled and no according data is sent or receipt.
			LS interface	The Interconnectivity function send and receives data according to the control files via the configured load share interface. (Refer to ↪ 9924.) Note: The interconnectivity does not work (is disabled) if the load share interface is configured to "CAN".
			Ethernet A	The Interconnectivity function send and receives data according to the control files via Ethernet A.
			Ethernet B	The Interconnectivity function send and receives data according to the control files via Ethernet B.

ID	Parameter	CL	Setting range [Default]	Description
			Ethernet C	The Interconnectivity function send and receives data according to the control files via Ethernet C.

4.8 Configure LogicsManager

Logical symbols

The easYgen LogicsManager screens show logical symbols according to the IEC standard by default. However, it is also possible to change the LogicsManager screens to ASA standard.

ID	Parameter	CL	Setting range [Default]	Description
4117	Use ASA symbols	2	Yes	Symbols according to the ASA standard are used in LogicsManager screens.
			[No]	Symbols according to the IEC standard are used in LogicsManager screens.



Refer to [“9.3.3 Logical Symbols”](#) for a table of symbols according to the different standards.

Refer to [“9.3.1 LogicsManager Overview”](#) for an introduction how a LogicsManager works.

4.8.1 Configure Internal Flags

Internal flags within the LogicsManager logical outputs may be programmed and used for multiple functions.

Flag {x}	Flag 1	Flag 2	Flag 3	Flag 4	Flag 5	Flag 6	Flag 7	Flag 8
Parameter ID	12230	12240	12250	12260	12270	12280	12290	12300
Result ID	10700	10701	10702	10702	10704	10705	10706	10707
Description ID	12053	12054	12055	12056	12057	12058	12059	12060

Table 96: Flag parameter IDs (1 to 8)

Flag {x}	Flag 9	Flag 10	Flag 11	Flag 12	Flag 13	Flag 14	Flag 15	Flag 16
Parameter ID	12910	12911	12912	12913	12914	12915	12916	12917
Result ID	11609	11610	11611	11612	11613	11614	11615	11616

Flag {x}	Flag 9	Flag 10	Flag 11	Flag 12	Flag 13	Flag 14	Flag 15	Flag 16
Description ID	12061	12062	12063	12064	12065	12066	12067	12068

Table 97: Flag parameter IDs (9 to 16)

Flag {x}	Flag 17	Flag 18	Flag 19	Flag 20	Flag 21	Flag 22	Flag 23	Flag 24
Parameter ID	12231	12233	12235	12237	12241	12243	12245	12247
Result ID	12232	12234	12236	12238	12242	12244	12246	12248
Description ID	12069	12070	12071	12072	12073	12074	12075	12076

Table 98: Flag parameter IDs (17 to 24)

Flag {x}	Flag 25	Flag 26	Flag 27	Flag 28	Flag 29	Flag 30	Flag 31	Flag 32
Parameter ID	12251	12253	12255	12257	12261	12263	12265	12267
Result ID	12252	12254	12256	12258	12262	12264	12266	12268
Description ID	12077	12078	12079	12080	12081	12082	12083	12084

Table 99: Flag parameter IDs (25 to 32)

ID	Parameter	CL	Setting range [Default]	Description
Parameter ID	Flag {x}	2	Determined by LogicsManager {XX.XX} [(0 & 1) & 1] = {nnnnn}	The flags may be used as auxiliary flags for complex combinations by using the logical output of these flags as command variable for other logical outputs. Notes Flag 1 is also used as placeholder in other logical combinations. Flag 8 is preset with a timer start and shows different default values. {XX.XX} is a placeholder for the LogicsManager number {nnnnn} is a placeholder for the parameter ID of the logical output of the LogicsManager equation
Description ID	Description {1 - 32}	2	user-defined (up 22 to characters) [LM Internal Value {1 - 32}]	The text may have 0 through 22 characters. Notes This parameter may only be configured using ToolKit. The max. number of characters depends on the numbers of bytes for each character. Please verify the length on the display for best view.



For conditions and explanation of programming please refer to [“9.3.1 LogicsManager Overview”](#).

4.8.2 Configure LSx

In systems of easYgen together with LSx the LSx command flags described below may be configured via easYgen LogicsManager to send binary information to the LSx LogicsManager system. Within the LSx these commands appear as LogicsManager command variables as well.

LSx command {x}	LSx command 1	LSx command 2	LSx command 3	LSx command 4	LSx command 5	LSx command 6
Parameter ID {yyyyy}	12979	12980	12981	12982	12983	12984
Not applicable for application mode	A08 A09 A11	A08 A09 A11	A10 A11	A10 A11	—	—

Table 100: LSx command flag IDs

ID	Parameter	CL	Setting range [Default]	Description
{yyyyy}	LSx command {x}	2	Determined by LogicsManager {XX.XX} [(0 & 1) & 1] = {nnnnn}	All these single command variables of all easYgen devices are offered in the connected LSx units. In the LSx the flags appear in two ways: <ul style="list-style-type: none"> • aligned (logical OR) and • individually. See drawing below.
				Notes The results can also be used within the easYgen own LogicsManager system (LM: 87.23 to 87.28). {XX.XX} is a placeholder for the LogicsManager number {nnnnn} is a placeholder for the parameter ID of the logical output of the LogicsManager equation

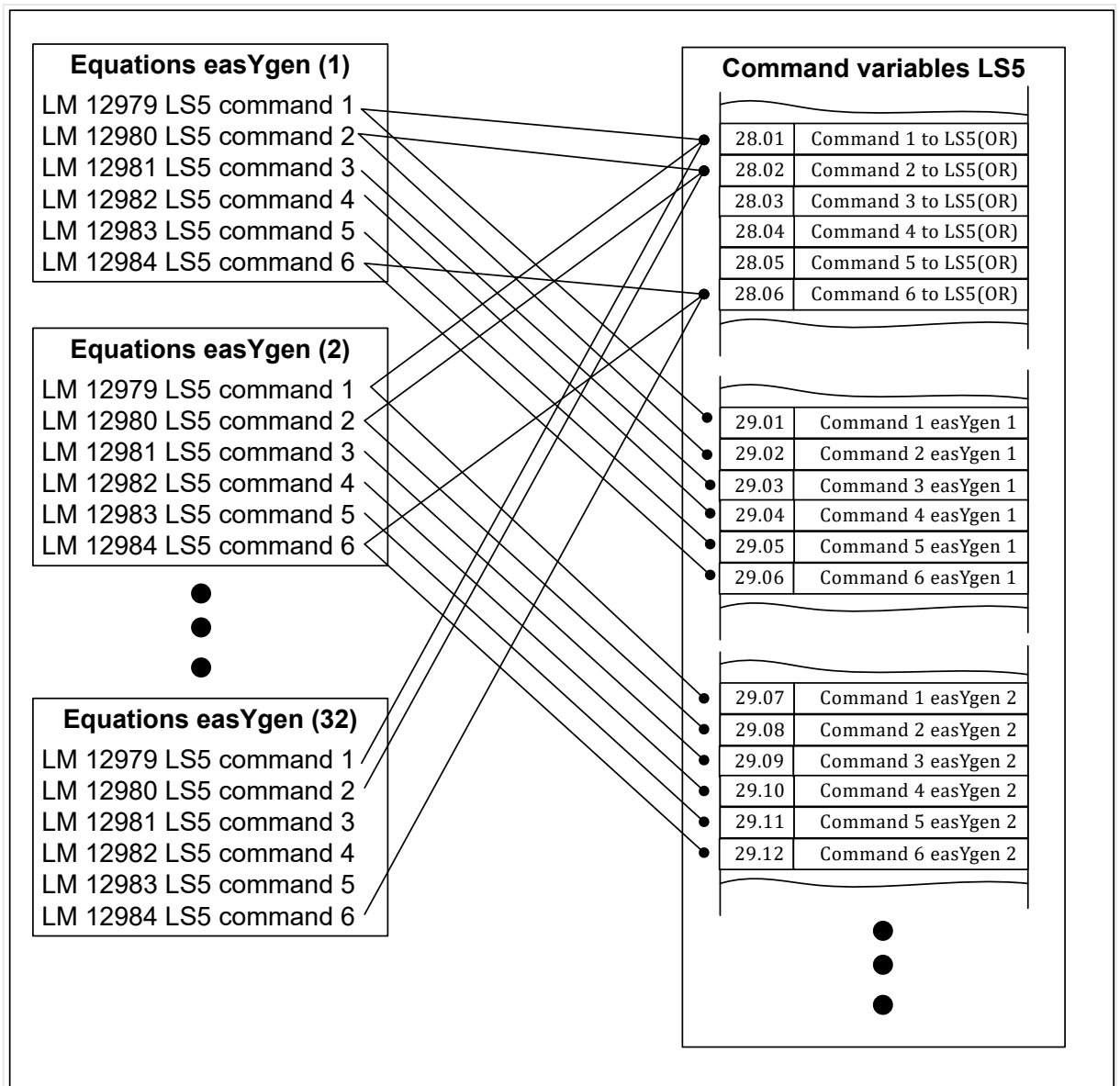

Fig. 240: LM flags of easYgen transferred to LS-5 (LSx)



For conditions and explanation of programming please refer to [“9.3.1 LogicsManager Overview”](#).

4.8.3 Set Timers



Daily time setpoints - Timer 1, 2

Utilizing the LogicsManager it is possible to establish specific times of the day that functions (i.e. generator test run or or engine pre-lubrication) can be enabled.

The two daily time flags are activated each day at the configured time. The both flags will be RESET at the end of the day on exact 23h.59m.59s. The both timer flags are independent of each other and are considered as intermediate flags to create a special control flag or function. Using the LogicsManager, the flags can be configured individually or both flags can be combined to create a time range. Refer to chapter example to understand their meaning better. Refer to [“6.3.19 Examples timer configuration”](#).



Note:

If the RTC time is within the configured time (with hour, minute and second), a latch with the corresponding LM Timer flag (11.01, 11.02) becomes TRUE. This latch and the LM flags will be **reset** each day at the time the RTC time 23:59:59 is reached. It is very important to consider that, when testing the function. For a complete test of the configuration it is recommended to let the RTC pass the configured time (even the 23.59.29 reset time).



Active time setpoint

Utilizing the LogicsManager it is possible to establish specific days (and/or hours, minutes, seconds) that functions (i.e. generator exerciser) can be enabled. The active switching point is activated only on a specified day (and/or hour, minute, second).

The setpoints may be configured individually or combined via the LogicsManager. You may configure for each month: daily, hourly, minutely, and/or even secondly time setpoints depending on how you combine the setpoints in the LogicsManager.



Active week days - weekly time setpoint

Utilizing the LogicsManager it is possible to establish specific days of the week that functions (i.e. generator exerciser) can be enabled.

The weekly time setpoint is enabled during the indicated day from 0:00:00 hours to 23:59:59 hours.



Timer weekly 1 - 7 setpoints

Utilizing the LogicsManager it is possible to establish specific times of the week that functions (i.e. generator exerciser) can be enabled.

There are seven independent Timer weekly flags available. Each timer has its separate start and stop setpoints

A Timer weekly flag is activated when the RTC time reaches the start setpoints (weekday, hour, minute, second) and stays active until the stop setpoints (weekday, hour, minute, second) are reached (refer to [“Timer weekly 1 - 7 settings”](#)).



For examples refer to [↪ “6.3.19 Examples timer configuration”](#)

Daily time setpoints - Timer 1, 2

ID	Parameter	CL	Setting range [Default]	Description
1652 1657	Timer 1: Hour	2	0 to 23 h 1652: [17 h] 1657: [17 h]	Enter the hour of the daily time setpoint here. Example <ul style="list-style-type: none"> • 0 = 0th hour of the day (midnight). • 23 = 23rd hour of the day (11pm).
1651 1656	Timer 1: Minute	2	0 to 59 min [0 min]	Enter the minute of the daily time setpoint here. Example <ul style="list-style-type: none"> • 0 = 0th minute of the hour. • 59 = 59th minute of the hour.
1650 1655	Timer 1: Second	2	0 to 59 s [0 s]	Enter the second of the daily time setpoint here. Example <ul style="list-style-type: none"> • 0 = 0th second of the minute. • 59 = 59th second of the minute.

Active time setpoint

ID	Parameter	CL	Setting range [Default]	Description
1663	Active day	2	Day 1 to 31 [1]	Enter the day of the active switch point here. The active time setpoint is enabled during the indicated day from 0:00:00 hours to 23:59:59 hours. Example <ul style="list-style-type: none"> • 01 = 1st day of the month. • 31 = 31st day of the month.
1662	Active hour	2	0 to 23 h [12 h]	Enter the hour of the active switch point here. The active time setpoint is enabled every day during the indicated hour from minute 0 to minute 59.

ID	Parameter	CL	Setting range [Default]	Description
				<p>Example</p> <ul style="list-style-type: none"> • 0 = 0th hour of the day. • 23 = 23rd hour of the day.
1661	Active minute	2	0 to 59 min [0 min]	<p>Enter the minute of the active switch point here.</p> <p>The active time setpoint is enabled every hour during the indicated minute from second 0 to second 59.</p> <p>Example</p> <ul style="list-style-type: none"> • 0 = 0th minute of the hour. • 59 = 59th minute of the hour.
1660	Active second	2	0 to 59 s [0 s]	<p>Enter the second of the active switch point here.</p> <p>The active time setpoint is enabled every minute during the indicated second.</p> <p>Example</p> <ul style="list-style-type: none"> • 0 = 0th second of the minute. • 59 = 59th second of the minute.

Active week days - weekly time setpoint

ID	Parameter	CL	Setting range [Default]	Description
				Please select each of the active weekdays.
1670	Monday active	2	[Yes]	The switch point is enabled every Monday.
			No	The switch point is disabled every Monday.
1671	Tuesday active	2	[Yes]	The switch point is enabled every Tuesday.
			No	The switch point is disabled every Tuesday.
1672	Wednesday active	2	[Yes]	The switch point is enabled every Wednesday.
			No	The switch point is disabled every Wednesday.
1673	Thursday active	2	[Yes]	The switch point is enabled every Thursday.
			No	The switch point is disabled every Thursday.

ID	Parameter	CL	Setting range [Default]	Description
1674	Friday active	2	[Yes]	The switch point is enabled every Friday.
			No	The switch point is disabled every Friday.
1675	Saturday active	2	Yes	The switch point is enabled every Saturday.
			[No]	The switch point is disabled every Saturday.
1676	Sunday active	2	Yes	The switch point is enabled every Sunday.
			[No]	The switch point is disabled every Sunday.

Timer weekly 1 - 7 settings

ID	Parameter	CL	Setting range [Default]	Description
1664	Timer weekly 1: Start day	2	[Monday]	This parameter defines the start weekday when the timer shall become active.
1666			Tuesday	
1668			Wednesday	
1677			Thursday	
1679			Friday	
1681			Saturday	
1683			Sunday	
1606	Timer weekly 1: Start hour	2	0 to 23 h	This parameter defines the start hour when the timer shall become active.
1612			[17 h]	
1618				
1624				
1630				
1636				
1642				
1607	Timer weekly 1: Start minute	2	0 to 59 min	This parameter defines the start minute when the timer shall become active.
1613			[0 min]	
1619				
1625				
1631				
1637				
1643				

4 Configuration
4.8.3 Set Timers

ID	Parameter	CL	Setting range [Default]	Description
1608 1614 1620 1626 1632 1638 1644	Timer weekly 1: Start second	2	0 to 59 s [0 s]	This parameter defines the start second when the timer shall become active.
1665 1667 1669 1678 1680 1682 1684	Timer weekly 1: Stop day	2	[Monday] Tuesday Wednesday Thursday Friday Saturday Sunday	This parameter defines the stop weekday when the timer shall become inactive.
1609 1615 1621 1627 1633 1639 1645	Timer weekly 1: Stop hour	2	0 to 23 h [17 h]	This parameter defines the stop hour when the timer shall become inactive.
1610 1616 1622 1628 1634 1640 1646	Timer weekly 1: Stop minute	2	0 to 59 min [0 min]	This parameter defines the stop minute when the timer shall become inactive.
1611 1617 1623 1629 1635 1641	Timer weekly 1: Stop second	2	0 to 59 s [0 s]	This parameter defines the stop second when the timer shall become inactive.

ID	Parameter	CL	Setting range [Default]	Description
1647				

4.8.4 Lamp Test

ID	Parameter	CL	Setting range [Default]	Description
12884	Lamp test	2	Determined by LogicsManager 87.89 [(0 & 1) & 1]	If this LogicsManager condition is TRUE the lamp test is active.

4.9 Configure AnalogManager

4.9.1 Operations

An AnalogManager (AM) is a flexible system to process and/or generate both an analog output signal and a related digital output. It offers a set of functions (Type) to select the preferred signal processing. According to the selected Type the AM takes up to two analog inputs and eventually one analog constant to calculate the result. Additionally up to two digital inputs are considered to control the process. The internal logic of the selected Type defines the boolean output signal.

Inputs:

- Up to 2 analog variables (A1, A2) and
 - 1 direct configurable constant (C1)
- in conjunction with
- up to 2 Boolean information (L1, L2)*.

The AM processes the inputs listed above depending on the **selected "Type"**. The result is always provided in form of

- an analog value (AR) and
- a Boolean (BR).

There are two types of AnalogManagers:

- Freely usable AM to process signals and use the results for output as control.
- Dedicated AM which analog result is directly accepted by (fixed to) an according function (e.g. AO01).

For both freely and dedicated AM is valid:

- The analog result is accessible via the AnalogManager command variable pool.

- The resulting Boolean is accessible via the LogicsManager command variable pool.

Preferred AM Definition Procedure

1. ▷ Start with "Type"
 - ▶ Select AM type first to get the picture and the visual understanding of available inputs, outputs, function, and results.
2. ▷ Select analog inputs and set constant.

i Besides internal and measured values there are 16 »Free constants« available for more flexibility. Refer to [4.9.2 AnalogManager Constants](#) for details.
3. ▷ Prepare each digital input by selecting source (parameter) and logical function.
4. ▷ Enter with "Apply"
 - ▶ Press »Apply« button to send current settings to device.
5. ▷ Use analog and boolean result for intended (re)action.

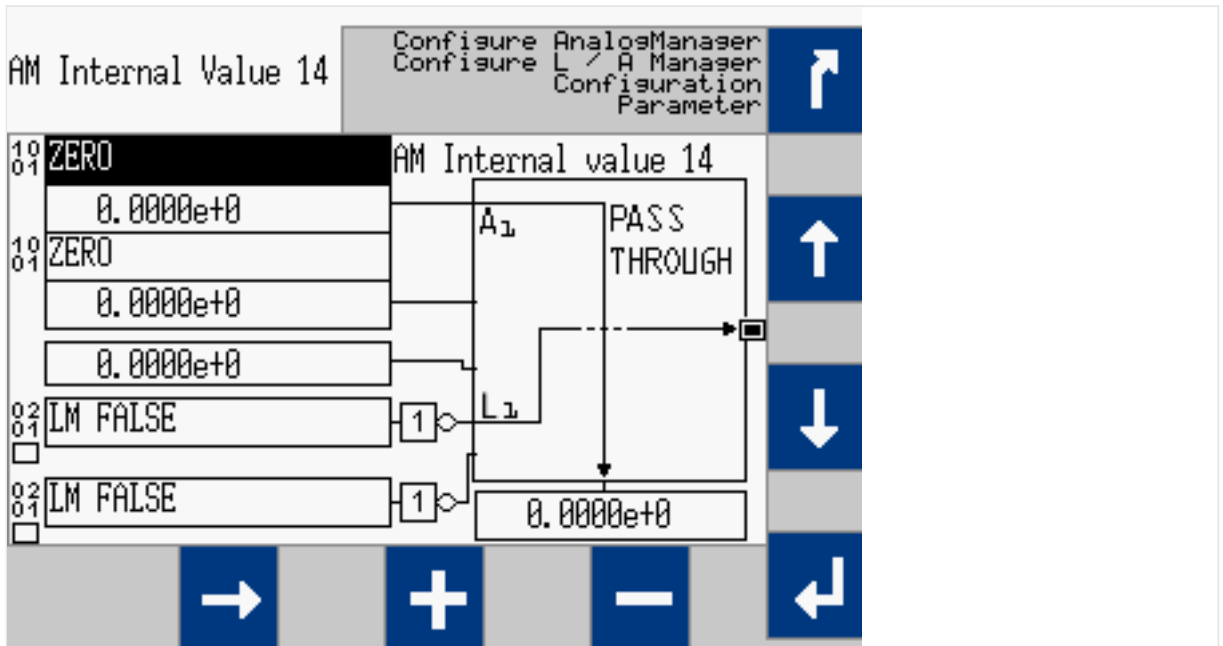

Fig. 241: Display (HMI) AM14

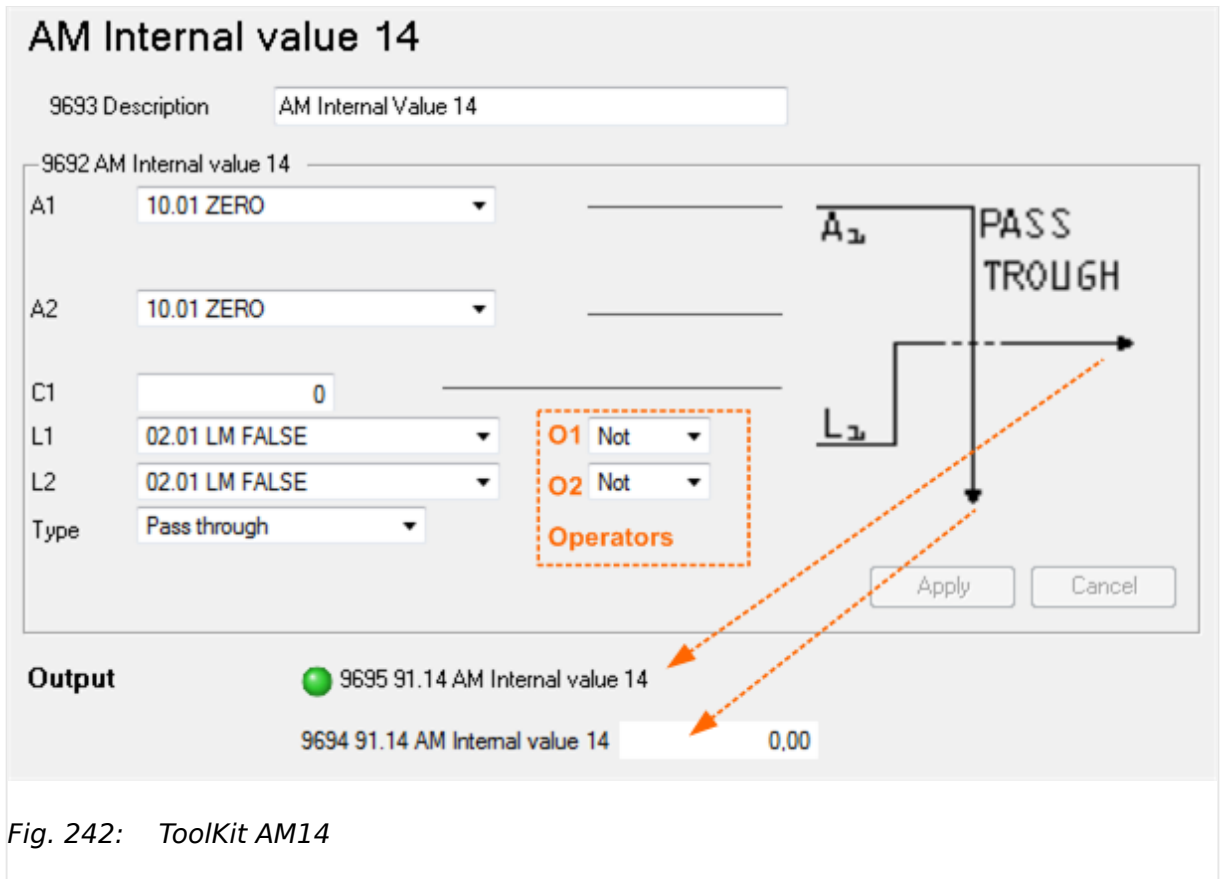

Fig. 242: ToolKit AM14



*) Please be aware that the boolean information passes an operator. So the input for the AnalogManager function block is **the result** of this!

AnalogManager Description

Acronym	Name	Value
A1	Analog input 1 (variable)	coming from selected analog parameter
A2	Analog input 2 (variable)	coming from selected analog parameter
C1	Analog C onstant input (constant)	defined via HMI, ToolKit, or other (remote) interface
		Notes ToolKit can display input values between -9.9999e9 and +9.9999e9. Other values will be handled correctly by the device but display will be cropped
L1	Boolean (L ogic) input 1	coming from selected digital parameter
L2	Boolean (L ogic) input 2	coming from selected digital parameter
O1	Operator 1 (Operators-Unary 1)	selected via HMI, ToolKit, or other (remote) interface
O2	Operator 2 (Operators-Unary 2)	selected via HMI, ToolKit, or other (remote) interface
Type	AnalogManager type (operation)	selected via HMI, ToolKit, or other (remote) interface
BR	Boolean result	result/output of the boolean operation
		Notes

Acronym	Name	Value
		Available as LogicsManager Variable ("result") e.g. as AM/LM input
AR	Analog result	result/output of the analog operation
		Notes Available as AnalogManager "result" e.g. as AM input

AnalogManager Internal Values 1 to 16

Internal values within the AnalogManager analogue and logical outputs may be programmed and used for multiple functions.

Flag	Value 1	Value 2	Value 3	Value 4	Value 5	Value 6	Value 7	Value 8
Parameter ID	9640	9644	9648	9652	9656	9660	9664	9668
Description ID	9641	9645	9649	9653	9657	9661	9665	9669
Analog Result ID	9642	9646	9650	9654	9658	9662	9666	9670
Logical Result ID	9643	9647	9651	9655	9659	9663	9667	9671

Table 101: Internal Values parameter IDs (1 to 8)

Value	Value 9	Value 10	Value 11	Value 12	Value 13	Value 14	Value 15	Value 16
Parameter ID	9672	9676	9680	9684	9688	9692	9696	9700
Description ID	9673	9677	9681	9685	9689	9683	9697	9701
Analog Result ID	9674	9678	9682	9686	9690	9684	9698	9702
Logical Result ID	9675	9679	9683	9687	9691	9685	9699	9703

Table 102: Internal Values parameter IDs (9 to 16)

i

Default values

Factory settings of the internal values come with Type = "Pass through" so the analog result AR is same as analog input A1 (Default: A1 = 10.01 ZERO). The boolean result BR is "FALSE".

ID	Parameter	CL	Setting range [Default]	Description
Parameter ID	AM Internal value 1 {1 - 16}	2	Determined by AnalogManager [A1 = 10.01 ZERO]	The data source may be selected from the available data sources. Notes Refer to 9.4.2 Data Sources AM for a list of all data sources.
Description ID	Description {1 - 16}	2	user-defined (up 22 to characters) [AM Internal value 1 {1 - 16}]	The text may have 0 through 22 characters. Notes

ID	Parameter	CL	Setting range [Default]	Description
				<p>This parameter may only be configured using ToolKit.</p> <p>The max. number of characters depends on the numbers of bytes for each character.</p> <p>Please verify the length on the display for best view.</p>



The analog and logic results can be used via analog variables “91.01 AM Internal value 1” - “91.16 AM Internal value 16” and via command “91.01 AM Internal value 1” - “91.16 AM Internal value 16”.

Examples

* **Calculating with an AnalogManager**

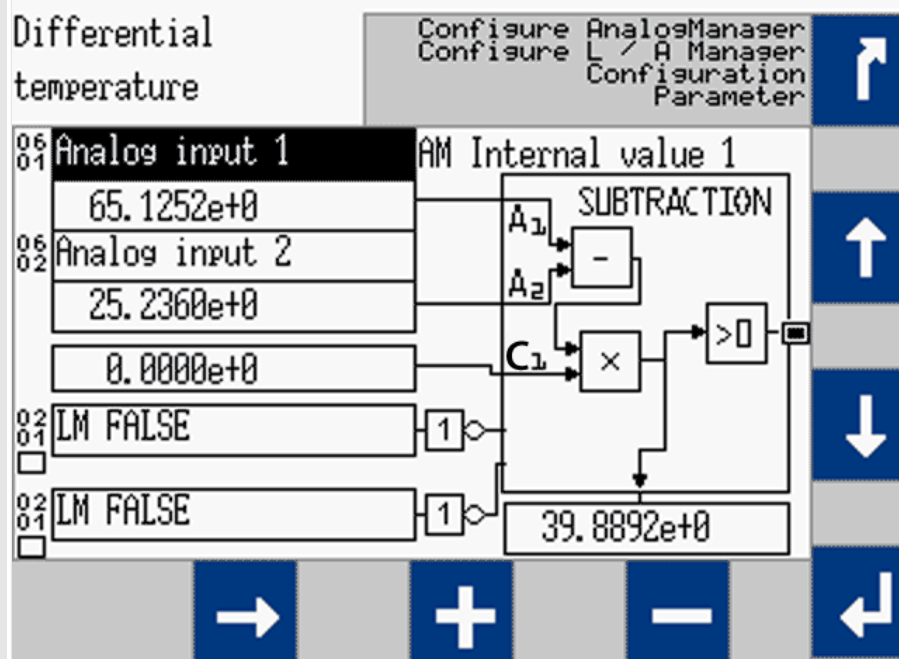

Fig. 243: screen shot HMI: AM subtraction sample

Acronym	Name	Value	
A1	Analog input 1	Number:	06.01
		Name:	Analog Input 1
		Value:	65.1252
A2	Analog input 2	Number:	06.02
		Name:	Analog Input 2
		Value:	25.2360
C1	Analog constant input	Value:	0
L1	Boolean input 1	Number:	02.01
		Name:	LM FALSE
		Value:	0
L2	Boolean input 2	Number:	02.01
		Name:	LM FALSE
		Value:	0
O1	Operator 1	NOT [input will be inverted]	
O2	Operator 2	NOT [input will be inverted]	
Type	Operation type	SUBTRACTION	
BR	Boolean result	(A1 - A2) x C1 > 0 (available as boolean result »91.01 AM Internal value 1«)	
AR	Analog result	(A1 - A2) x C1 (available as analog result »91.01 AM Internal value 1«)	

* **Incrementing and comparing with an AnalogManager**

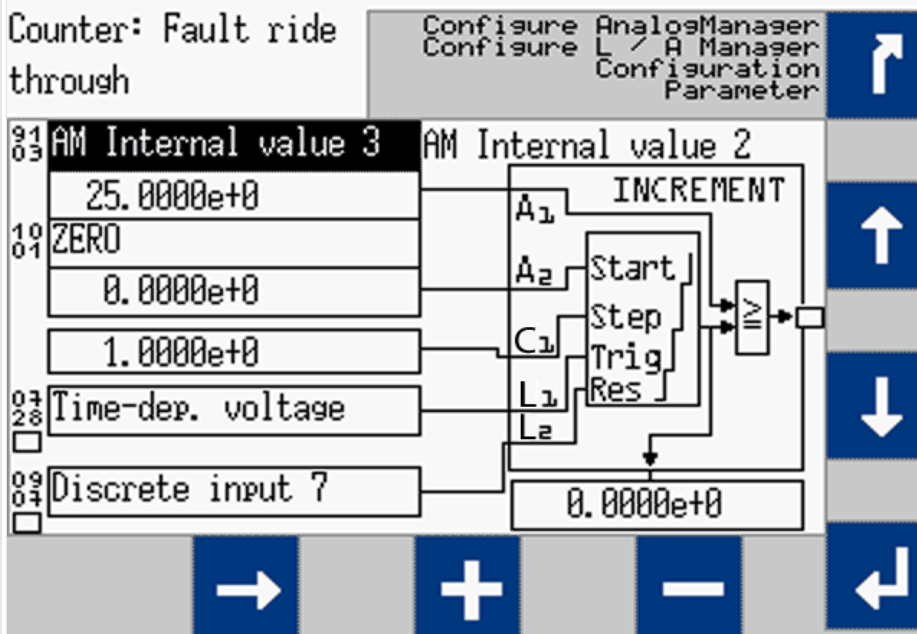

Fig. 244: screen shot HMI: AM increment sample

Acronym	Name	Value	
A1	Analog input 1	Number:	91.03
		Name:	Internal value 3
		Value:	25.0000
A2	Analog input 2	Number:	10.01
		Name:	ZERO
		Value:	0
C1	Analog constant input	Value:	1.000
L1	Boolean input 1	Number:	07.28
		Name:	Time dependent voltage
		Value:	Result of LM 07.28
L2	Boolean input 2	Number:	09.07
		Name:	Discrete input 7
		Value:	Result of LM 09.07
O1	Operator 1	L1 [passed]	
O2	Operator 2	L2 [passed]	
Type	Operation type	INCREMENT	
BR	Boolean result	$A1 \geq A2 + (n[L1] \times C1)^*$ *) Reset if L2 = TRUE (available as boolean result »91.02 AM Internal value 2«)	
AR	Analog result	$A2 + (n[L1] \times C1)^*$ *) Reset if L2 = TRUE (available as analog result »91.02 AM Internal value 2«)	

The following AnalogManager operations are available:



New AnalogManager "Type" selected? Then: ...

Please be aware that the input values stay "as is" (are NOT changed) if a new Type is selected. Check all input settings A1, A2, C1, L1, L2, O1, O2 before applying!

Example:

If A2 = 0 and you select Type "Divide", you would ask the AnalogManager to divide by zero!

AnalogManager Operation (Type)	Bitmap	Function (Output)
Pass through		Analog Result = A1 Boolean Result = L1
Constant		Analog Result = C1 Boolean Result = L1
Summation		Analog Result = (A1 + A2) * C1 Boolean Result goes TRUE, if Analog Result > 0
Subtraction		Analog Result = (A1 - A2) * C1 Boolean Result goes TRUE, if Analog Result > 0

AnalogManager Operation (Type)	Bitmap	Function (Output)
Limit Switch		<p>Analog Result = $(A1 - A2)$</p> <p>L1 = FALSE -> Overrun mode: Boolean Result goes TRUE, if $A1 > A2$ Boolean Result goes FALSE, if $A1 \leq (A2 - C1)$</p> <p>L1 = TRUE -> Underrun mode: Boolean Result goes TRUE, if $A1 < A2$ Boolean Result goes FALSE, if $A1 \geq (A2 + C1)$</p> <p>C1 = Hysteresis</p> <p>L1 = TRUE = Underrun mode, otherwise Overrun mode</p> <p>L2 = Resets Hysteresis.</p>
Compare with Delay On		<p>Analog Result = $(A1 - A2)$</p> <p>Boolean Result goes TRUE, if $A1 > A2$ for the duration of C1 time [s], otherwise FALSE</p> <p>C1 = Time Delay to switch on [s]</p> <p>L2 = Reset Time Delay. Absolute value of C1 is taken as time [s] (no negative time).</p> <p>Notes</p> <p>Time is not latched, so C1 changes can be done during delay cycle.</p>
Multiply type A		<p>Analog Result = $(A1 * A2) + C1$</p> <p>Boolean Result goes TRUE, if Analog Result > 0</p>
Multiply type B		<p>Analog Result = $A1 + (A2 * C1)$</p> <p>Boolean Result goes TRUE, if Analog Result > 0</p>
Multiply type C		<p>Analog Result = $A1 * A2 * C1$</p> <p>Boolean Result goes TRUE, if Analog Result > 0</p>

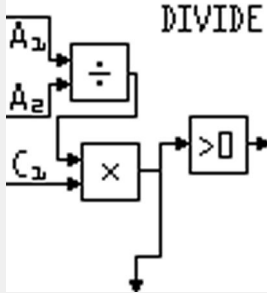
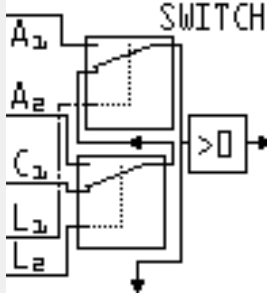
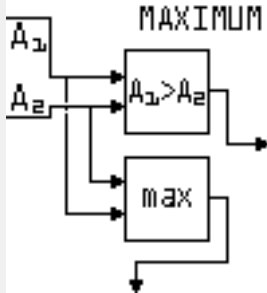
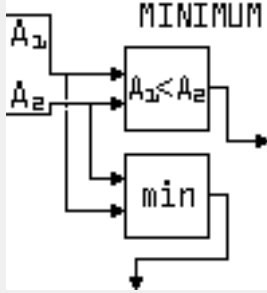
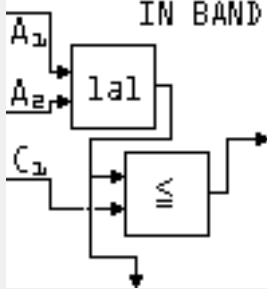
AnalogManager Operation (Type)	Bitmap	Function (Output)
Divide	 <p>The diagram shows two analog inputs, A₁ and A₂, entering a divider block (÷). The output of the divider is multiplied by a constant C₁ in a multiplier block (×). The final output is compared against zero (>0) to produce a Boolean result.</p>	<p>Analog Result = $(A_1 / A_2) * C_1$</p> <p>Boolean Result goes TRUE, if Analog Result > 0</p>
Switch	 <p>The diagram shows two analog inputs, A₁ and A₂, and two logic inputs, L₁ and L₂. A switch block selects between A₁ and A₂ based on L₁ and L₂. The selected signal is multiplied by C₁ and then compared against zero (>0) to produce a Boolean result.</p>	<p>Analog Result = A₁, if L₁ = TRUE</p> <p>Analog Result = A₂, if L₁ = FALSE AND L₂ = TRUE</p> <p>Analog Result = C₁, if L₁ = FALSE AND L₂ = FALSE</p> <p>Boolean Result goes TRUE, if Analog Result > 0</p> <p>Notes</p> <p>Icon shows switch positions L₁/L₂ as FALSE.</p> <p>Common use could be to switch between A₁ and A₂: Set L₂ = TRUE; use L₁ to switch.</p>
Maximum	 <p>The diagram shows two analog inputs, A₁ and A₂. A comparator block (A₁ > A₂) compares the two inputs. The output of the comparator is used to select the maximum value between A₁ and A₂ in a 'max' block.</p>	<p>Analog Result = MAX(A₁ , A₂)</p> <p>Boolean Result goes TRUE, if A₁ > A₂</p>
Minimum	 <p>The diagram shows two analog inputs, A₁ and A₂. A comparator block (A₁ < A₂) compares the two inputs. The output of the comparator is used to select the minimum value between A₁ and A₂ in a 'min' block.</p>	<p>Analog Result = MIN(A₁, A₂)</p> <p>Boolean Result goes TRUE, if A₁ < A₂</p>
In Band	 <p>The diagram shows two analog inputs, A₁ and A₂, entering an absolute value block (a). The output of the absolute value block is compared against a constant C₁ in a less-than-or-equal-to block (≤) to produce a Boolean result.</p>	<p>Analog Result = ABS(A₁ - A₂)</p> <p>Boolean Result goes TRUE, if (ABS(A₁ - A₂) ≤ C₁)</p> <p>C₁ = maximum tolerance for being "in band"</p>

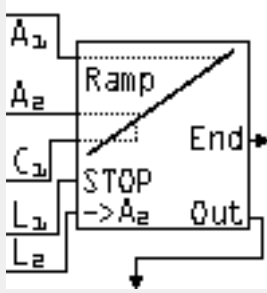
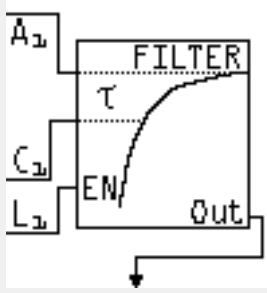
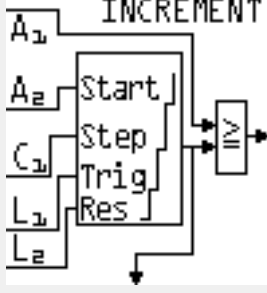
AnalogManager Operation (Type)	Bitmap	Function (Output)
Ramp		<p>Analog Result = Ramp value</p> <p>Boolean Result goes TRUE, if Ramp value equal end position</p> <p>C1 determines rate/second. Absolute value of C1 is taken - no negative rate allowed</p> <p>L1 holds ramp: If L1 goes TRUE, the current ramp output is stopped</p> <p>L2 determines end value: If L2 goes TRUE, the end position is value A2, otherwise it is A1.</p> <p>Notes</p> <p>Rate/second is not latched, so C1 changes can be done during ramp cycles.</p> <p>Common use could be ramp up and down: Start ramping from A1 to A2 with gradient C1 if L1 goes TRUE; then switch to ramping down back to A1 with the same gradient if L2 goes TRUE.</p>
Filter		<p>Analog Result = Filtered value of A1</p> <p>Boolean Result = FALSE.</p> <p>A1 = Value, which is to filter. A2 not used.</p> <p>C1 is filter time (time constant) in [s]</p> <p>L1 switches the filter. If L1 goes TRUE, the filter function is enabled, otherwise the filter function is disabled and the Analog Result = A1</p> <p>L2 not used. Absolute value of C1 is taken</p> <p>Notes</p> <p>Time constant is not latched, so C1 changes can be done during filter cycles.</p> <p>Filter formula: $OUT[i] = a \cdot IN[i] + (1-a) \cdot OUT[i-1]$, where $OUT[i]$ is current output, $IN[i]$ is current input, and $OUT[i-1]$ is previous output. $a = (dT / (C1 + dT))$, where dT is interval of input/output change ($==$ RATEGROUP)</p>
Increment		<p>Analog Result = Analog Result + C1 on every L1 rising edge</p> <p>Boolean Result goes TRUE, if Analog Result > = Value A1 (Limit)</p> <p>A1 = Limit</p> <p>A2 = Start Value after RESET</p> <p>C1 = Increment per Step</p> <p>L1 = Trigger for Increment</p> <p>L2 = Reset to Start Value</p>

AnalogManager Operation (Type)	Bitmap	Function (Output)
Latch		<p>Analog Result = A1 on every L1 rising edge</p> <p>Boolean Result goes TRUE, if Analog Result > 0</p> <p>A1 = Value 1</p> <p>L1 = Saves Analog Result with rising edge</p> <p>L2 = Resets Analog Result to 0 with rising edge</p>
Timer		<p>Analog Result = Elapsed time [s]</p> <p>Boolean Result goes TRUE, if Analog Result > = C1</p> <p>C1 = Timer Compare [s]</p> <p>L1 = If L1 goes TRUE, timer starts or continues to run, otherwise timer is stopped</p> <p>L2 = Resets Analog Result to 0 with rising edge</p> <p>Notes</p> <p>Could be used e.g., for reading out values when a defined (failure) situation occurs</p>
Maxtrack		<p>Analog Result = If A1 > Analog Result, the new result is A1</p> <p>Boolean Result goes TRUE, if Analog Result > = C1</p> <p>A1 = Tracked Value</p> <p>A2 not used</p> <p>C1 = Limit</p> <p>L2 = Resets Analog Result to A2 with rising edge.</p>
Mintrack		<p>Analog Result = If A1 < Analog Result, the new result is A1</p> <p>Boolean Result goes TRUE, if Analog Result < = C1</p> <p>A1 = Tracked Value</p> <p>C1 = Limit</p> <p>L2 = Resets Analog Result to A2 with rising edge.</p>
Delay type A		<p>Mode "Delay On":</p> <p>Analog Result = Remaining time [s] for Boolean Result to go to TRUE</p> <p>Boolean Result goes TRUE, if L1 = TRUE for at least C1[s] time.</p> <p>Mode "Delay Off":</p> <p>Analog Result = Remaining time [s] for Boolean Result to go to FALSE</p> <p>Boolean Result goes FALSE, if L1 = FALSE for at least C1[ms] time</p> <p>C1 = Absolute value of C1 is taken as time in [s] (no negative time allowed)</p>

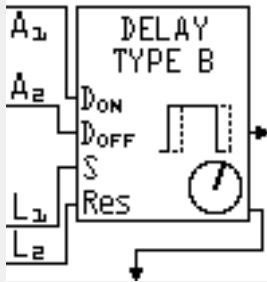
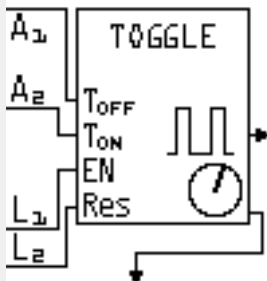
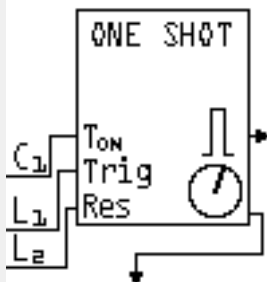
AnalogManager Operation (Type)	Bitmap	Function (Output)
		<p>L1 = Switching signal. The boolean result is delayed according to the mode in L2</p> <p>L2 = TRUE = Mode "Delay Off"; = FALSE = Mode "Delay On"</p> <p>Notes</p> <p>Time is not latched, so C1 changes can be done during delay cycle.</p>
Delay type B		<p>Analog Result = Remaining time [s] to switch Boolean Result</p> <p>Boolean Result = TRUE, if L1 was TRUE for at least A1 time [s]</p> <p>Boolean Result = FALSE, if L1 was FALSE for at least A2 time [s]</p> <p>A1 = Delay-On time [s], no negative time allowed</p> <p>A2 = Delay-Off time [s], no negative time allowed</p> <p>L1 = Switching signal. The boolean result is delayed according to the time A1 and A2</p> <p>L2 = Resets Boolean result with rising edge</p> <p>Notes</p> <p>A1/A2 Time is not latched, so changes can be done during delay cycle.</p>
Toggle		<p>Analog Result = Remaining time to switch Boolean Result</p> <p>Boolean Result = Toggles with ON time = A1[ms] and OFF time = A2[s]</p> <p>A1 = Delay-On time [ms], no negative time allowed</p> <p>A2 = Delay-Off time [ms], no negative time allowed</p> <p>L1 = Activates toggling, if TRUE. L2 = Resets remaining time to toggle with rising edge</p> <p>Notes</p> <p>A1/A2 Time is not latched, so changes can be done during delay cycle.</p>
One Shot		<p>Analog Result = Remaining time to fall back to FALSE [s]</p> <p>Boolean Result = L1 rising edge forces TRUE state for C1 time [s]</p> <p>C1 = Absolute value of C1 is taken as time in [s] (no negative time allowed)</p> <p>L1 = Activates boolean result to TRUE with rising edge</p> <p>L2 = Resets remaining time for fall back with rising edge</p> <p>Notes</p> <p>Time is not latched, so C1 changes can be done during monoflop cycle.</p>

4.9.2 AnalogManager Constants

General note

For even more flexibility and use of "self explaining" parameters 16 constants can be defined. These constants are available as AnalogManager input AM 13.01 to AM 13.16. Each parameter can be named individually and its value can be defined in a wide range:

AnalogManager Constants 1 to 16

AnalogManager values may be used for multiple functions.

AM Constant #	1	2	3	4	5	6	7	8
Description	15567	15568	15569	15570	15571	15572	15573	15574
Value	15551	15552	15553	15554	15555	15556	15557	15558
AM	AM 13.01	AM 13.02	AM 13.03	AM 13.04	AM 13.05	AM 13.06	AM 13.07	AM 13.08

Table 103: AM Constant IDs (1 to 8)

AM Constant #	9	10	11	12	13	14	15	16
Description	15575	15576	15577	15578	15003	15004	15005	15006
Value	15559	15560	15561	15562	15563	15564	15565	15566
AM	AM 13.09	AM 13.10	AM 13.11	AM 13.12	AM 13.13	AM 13.14	AM 13.15	AM 13.16

Table 104: AM Constant IDs (9 to 16)



Constant's name

The AM inputs selectable for A1 or A2 come with the predefined name of the Constant e.g. 13.01 Free constant 1" but not with the customizable AM Description e.g. the value of 15567 Description constant 1.

ID	Parameter	CL	Setting range [Default]	Description
15567 - 15578, 15003 - 15006	Description constant {1 - 16}	2	user-defined (up 22 to characters) [13.yy Free constant {1 - 16}]	The text may have 0 through 22 characters. Notes This parameter may only be configured using ToolKit. The max. number of characters depends on the numbers of bytes for each character. Please verify the length on the display for best view.
15551 - 15566	13.yy Free constant {1 - 16}	2	-21000.00 e3 to 21000.00 e3	Preset value to be used as AM 13.yy.

ID	Parameter	CL	Setting range [Default]	Description
			[1]	

4.10 Configure Counters

General notes

The following chapters describe all available and configurable counters of the device.

The standard/basic counters - available in all devices of this product family - are described in the chapter [↳ "4.10.1 Generator Preset Values"](#). For special counters please see the chapters following.

4.10.1 Generator Preset Values

General notes



Maintenance call

A maintenance call will be issued if the configured number of maintenance hours has expired or the configured number of days has expired since the last maintenance.

In case of a maintenance call, the display indicates "Mainten. days exceeded" or "Mainten. hours exceeded".

ID	Parameter	CL	Setting range [Default]	Description
2521	Gen.pos.active energy preset	2	000000.00 to 999999.00 MWh [0 MWh]	This parameter defines the number of MWh of the counter. The number entered here will overwrite the current displayed value after confirming with parameter ↳ 2510 .
2510	Gen.pos.active energy set	2	Yes	The current value of this counter is overwritten with the value configured in "Gen.pos.active energy preset" (parameter ↳ 2521). After the counter has been (re)set, this parameter changes back to "No" automatically.
			[No]	The value of this counter is not changed.
2523	Gen.pos.react.energy preset	2	000000.00 to 999999.00 Mvarh [0 Mvarh]	This parameter defines the number of positive Mvarh of the counter. The number entered here will overwrite the current displayed value after confirming with parameter ↳ 2511 .
2511	Gen.pos.react.energy set	2	Yes	The current value of this counter is overwritten with the value configured in "Gen.pos.react.energy preset"

ID	Parameter	CL	Setting range [Default]	Description
				(parameter ↩ 2523). After the counter has been (re)set, this parameter changes back to "No" automatically.
			[No]	The value of this counter is not changed.
2527	Gen.neg.react.energy preset	2	000000.00 to 999999.00 Mvarh [0 Mvarh]	This parameter defines the number of negative Mvarh of the counter. The number entered here will overwrite the current displayed value after confirming with parameter ↩ 2513 .
2513	Gen.neg.react.energy set	2	Yes	The current value of this counter is overwritten with the value configured in "Gen.neg.react.energy preset" (parameter ↩ 2527). After the counter has been (re)set, this parameter changes back to "No" automatically.
			[No]	The value of this counter is not changed.
2541	Number of starts preset	2	0 to 65535 [0]	This parameter defines the number of times the control unit registers a start of the generator set. The number entered here will overwrite the current displayed value after confirming with parameter ↩ 2542 .
2542	Number of starts set	2	Yes	The current value of the start counter is overwritten with the value configured in "Number of starts preset" (parameter ↩ 2541). After the counter has been (re)set, this parameter changes back to "No" automatically.
			[No]	The value of this counter is not changed.

4.10.2 Service Reset Values

General notes



Maintenance call



A maintenance call will be issued if the configured number of maintenance hours has expired or the configured number of days has expired since the last maintenance.



In case of a maintenance call, the display indicates "Mainten. days exceeded" or "Mainten. hours exceeded".



Displaying hours: operation / period of use

The easYgen device handles operating hours internally in floating format. To indicate the operating hours on a display or to provide it in the data protocol the value is transferred into an integer variable. This can cause display errors within $4 \cdot 10^{-6}$ % in relation to the absolute value.

ID	Parameter	CL	Setting range [Default]	Description
2550	Maintenance hours	2	0 to 9,999 h [300 h]	<p>This parameter defines the remaining hours until the next maintenance call occurs. Once the generator has been operated for the number of hours configured here, a maintenance message is displayed.</p> <p>If this value is changed, the counter is reset to the new value.</p> <p>If the maintenance counter is reset by the push-buttons at the front panel (refer to 2.1 Display And Status Indicators), or by configuring the parameter "Reset maintenance period hrs" to "Yes" (parameter 2562), the maintenance counter is reset to the configured value.</p> <p>Notes</p> <p>To disable the "maintenance hours" counter configure "0" for this entry.</p>
2562	Reset maintenance period hrs	2	Yes / No [No]	<p>If this parameter is configured to "Yes" the maintenance "hours" counter is reset to the configured value. Once the counter "maintenance hours" has been reset, the control unit changes this parameter to "No".</p> <p>Notes</p> <p>When using a specific code level in parameter 2567 to reset maintenance hours this parameter can be blocked.</p> <p>Notes</p> <p> - menu path: [Next Page / Configure counters /  (symbol: wrench)]</p>
2551	Maintenance days	2	0 to 999 d [365 d]	<p>This parameter defines the remaining days until the next maintenance call occurs. Once the configured number of days has expired since the last</p>

ID	Parameter	CL	Setting range [Default]	Description
				<p>maintenance, a maintenance message is displayed.</p> <p>If this value is changed, the counter is reset to the new value.</p> <p>If the maintenance counter is reset by the push-buttons at the front panel (refer to ↩ “2.1 Display And Status Indicators”), or by configuring the parameter "Reset maintenance period days" to "Yes" (parameter ↩ 2563), the maintenance counter is reset to the configured value.</p> <p>Notes</p> <p>To disable the "maintenance days" counter configure "0" for this entry.</p>
2563	Reset maintenance period days	2	Yes / No [No]	<p>If this parameter is configured to "Yes" the "maintenance days" counter is reset to the configured value. Once the counter has been reset, the control unit changes this parameter to "No".</p> <p>Notes</p> <p>When using a specific code level in parameter ↩ 2567 to reset maintenance days this parameter can be blocked.</p> <p>Notes</p> <p> - menu path: [Next Page / Configure counters /  (symbol: wrench)]</p>
2567	Code level for reset maint.	2	<p>0</p> <p>1</p> <p>[2]</p> <p>3</p>	<p>This parameter determines the required code level for resetting the counter "Maintenance call in...". User with a lower code level may not access this function.</p> <p>The following code levels exist:</p> <p>Operator</p> <p>Service level</p> <p>Temporary commissioner</p> <p>Commissioner</p> <p>Notes</p> <p>The code level defined here only affects the access via the front panel (HMI).</p>

ID	Parameter	CL	Setting range [Default]	Description
15154	Operation hours source	2		This parameter configures the source for the operation hours.
			[Internal]	The operation hours are counted internal from the easYgen
			ECU/J1939	The operation hours are assumed from the connected ECU (via J1939 CAN protocol).
2509	Operation hours preset	0	0.00 to 999,999.99 [0.00]	When setting the operating hours counter (refer to parameter ↩ 2574), the counter always will be set up to the value configured here.
2574	Operation hours set	0 ¹	Yes	The current value of this counter is overwritten with the value configured in "Operation hours preset" (parameter ↩ 2509). After the counter has been (re)set, this parameter changes back to "No" automatically.
			[No]	The value of this counter is not changed.
				Notes ¹ The code level can be configured with "Codelevel set operation hours" (parameter ↩ 2573). If your current code level does not match, this parameter is not visible.
2573	Code level set operation hours	5	0 to 5 [2]	This parameter defines which codelevel is necessary to set the operation hours (parameter ↩ 2574).
2515	Period of use preset	2	0.00 to 999,999.99 [0.00]	When setting the period of use hours counter (refer to parameter ↩ 2579), the counter always will be set up to the value configured here.
2579	Period of use set	0 ¹	Yes	The current value of this counter is overwritten with the value configured in "Period of use preset" (parameter ↩ 2515). After the counter has been (re)set, this parameter changes back to "No" automatically.
			[No]	The value of this counter is not changed.
				Notes ¹ The code level can be configured with "Code level f. set period of use" (parameter ↩ 2581). If your current code level does not match, this parameter is not visible.
2581	Code level f.set period of use	5	0 to 5	This parameter defines which codelevel is necessary to set the

ID	Parameter	CL	Setting range [Default]	Description
			[2]	period of use hours (parameter ↪ 2579).

4.10.3 Counter Pulses and Transistor Output

General notes

The easYgen monitors the increase of energy. A pulse signal can be configured to deliver a 20 ms pulse, if the defined amount of the selected energy is reached. Two pulse monitors are available.

Together with the two transistor outputs (via LogicsManager) it is easy to prepare energy counter pulses:

The frequency of the pulses is directly adjustable according to the increase of the amount of active power hours or reactive power hours. The length of the pulse and the logical condition are determined through LogicsManager equation (This is usually the transistor output equation).



- The pulse frequency has to be configured in a way, that the pulses are not generating a constant signal, when the maximum increase of power is measured.
- The pulse outputs of the energy counter are not calibrated!

Pulse signal A parameters

ID	Parameter	CL	Setting range [Default]	Description
13460	Source	2	<ul style="list-style-type: none"> • Off • ReactEnergy- • ReactEnergy+ • ActiveEnergy 	Selecting the energy type for counter impulse signal A.
			[Off]	Counter signal is disabled.
13462	One pulse for x kWh / kvarh	2	0.01 ... 100.00	Selecting the active energy amount per pulse for impulse signal A.
			[0.10]	
9200	Pulse signal A: Command variable 31.01	-	31.01 Pulse signal A	The generated pulse signal defined by 13460 and 13462 (above). Available as LogicsManager input.
12790	Transistor out 1	2	Determined by LogicsManager	If this LogicsManager condition is TRUE, the Transistor out 1 output will be enabled.
			[(0 & 1) & 1] = 99.33 / 11908 Notes For information on the LogicsManager and its default settings see ↪ “9.3.1 LogicsManager Overview” .	

Pulse signal B parameters

ID	Parameter	CL	Setting range [Default]	Description
13461	Source	2	<ul style="list-style-type: none"> • Off • ReactEnergy- • ReactEnergy+ • ActiveEnergy 	Selecting the energy type for counter impulse signal B.
			[Off]	Counter signal is disabled.
13463	One pulse for x kWh / kvarh	2	0.01 ... 100.00	Selecting the active energy amount per pulse for impulse signal B.
			[0.10]	
9201	Pulse signal A: Command variable 31.02	-	31.02 Pulse signal B	The generated pulse signal defined by 13461 and 13463 (above). Available as LogicsManager input.
12800	Transistor out 2	2	Determined by LogicsManager	If this LogicsManager condition is TRUE, the Transistor out 2 output will be enabled.
			[(0 & 1) & 1] = 99.34 / 11909	

The pulse signals A/B can be selected as an input of a LogicsManager equation (the transistor outputs 1 with ID 12790 and 2 with ID 12800 are recommended). The pulse signal (20 ms) is set for the refresh time of the LogicsManager equation. To control the switch pulse we propose to take the settings of the dedicated LogicsManager equation and add 100 ms pulse (delay) time:

For a **positive switch pulse** configure the LogicsManager equation with

- the delay-on time for starting the rising edge at 000.00 s and
- the delay-off time as a minimum pulse duration 000.10 s.

For a **negative switch pulse** configure the LogicsManager equation

- by adding a NOT block and setting
- the delay-off time for starting the falling edge at 000.00 s and
- the delay-on time as a minimum pulse duration 000.10 s.

Examples

Fig. 245: Connecting transistor counters

Count kWh:

- Configure »Pulse signal A« 31.01
 - select 13460 »Source«: ActiveEnergy
 - set 13462 »One pulse for x kWh / kvarh«: 0.1
- Configure LM »Transistor out 1« (12790)
 - select 31.01 Pulse signal A as input
 - adjust time for pulse duration Delay OFF: 0.1

Count kvarh:

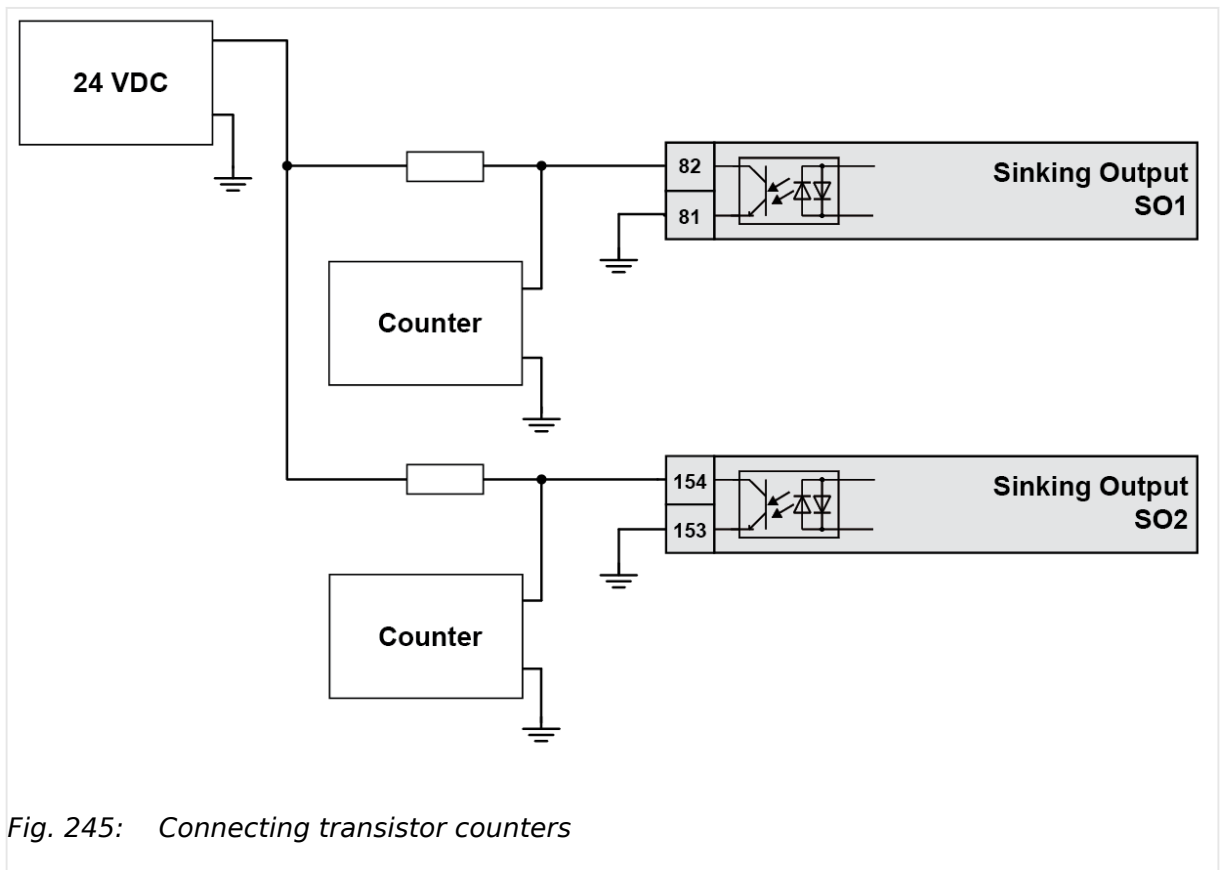
- Configure »Pulse signal B« 31.02
 - select 13461 Source: ReactEnergy+
 - set 13463 One pulse for x kWh / kvarh: 0.1
- Configure LM »Transistor out 2« (12800)
 - select 31.02 Pulse signal B as input
 - adjust time for pulse duration Delay OFF: 0.1

5 Operation

In operation the genset controller can be manually or remote controlled.

Front panel access is described in chapter [↳ “4.1 Front Panel Access”](#).

Access via ToolKit is described in the ToolKit Manual.

Access via Remote Panel PR-3000XT is described in chapter [↳ “4.3.6 Configure Remote Panel Mode”](#) and the Technical Manual »37593 RP-3000XT«.

Access via PLC depends on the interface and the data telegram used for communication.



For menu structure/menu tree see [↳ “Menu structure \(menu tree\)”](#).

5.1 Power ON

Behavior during starting easYgen-3000XT

The start-up procedure of the easYgen-XT device can be caused by the following reasons:

- Power ON
- Power cycling e.g. by [↳ 1701» Set factory default values«](#)
- Power is back after voltage drop

This process is visualized by the HMI of the plastic housing version or the LEDs of the metal housing version.



Using the USB Service Port

With power ON and a PC/laptop connected via USB service port it can happen that the USB window that pops up doesn't show all files and/or the correct available free memory at the device: Please unplug/plug the USB connection after the easYgen finished starting.

With power ON and connected USB service port it can happen that a connected USB device is not detected correctly: Please unplug/plug the USB connection after the easYgen finished starting.

With power cycle or reboot of the easYgen-XT the USB connection is lost: Please unplug/plug and/or start USB connection again after the easYgen finished starting.

... starting plastic housing (HMI) version

Power ON from zero power

- Buttons are illuminated
- Start-up screen appears
 - the red bar at the bottom monitors the degree of fulfillment
- HOME screen appears with measured values and state information

- Illumination of buttons is disabled according to the default settings STOP button still might be illuminated
- WARNING triangle is blinking if there are unacknowledged alarm messages

Power cycling

- Warning LED is twinkling in a high frequency
- (afterwards the standard process of Power ON is executed:)
- Buttons are illuminated
- Start-up screen appears
 - the red bar at the bottom monitors the degree of fulfillment
- HOME screen appears with the same measured values and state information as before power cycling

... starting metal housing version

Power ON from zero power

- LEDs are twinkling
- LEDs are illuminated according to the state of the genset control

Power cycling

- Warning LED is twinkling in a high frequency
- (afterwards the standard process of Power ON is executed:)
- LEDs are twinkling
- LEDs are illuminated according to the state of the genset control

5.2 Change Operating Modes

Startup

The genset controls starts in the operating mode defined by parameter 1795 »Startup in mode«. Refer to [↳ “4.4.5 Configure Operation Modes”](#) for details.

Select Operation Mode

Operation modes can be selected via

- front panel buttons (plastic housing variant or Remote Panel RP-3000XT or VNC client),
- HMI configuration (plastic housing variant or Remote Panel RP-3000XT or VNC client),
- remote settings via interfaces, or
- ToolKit

The following chapters describe the manually front panel access.

5.2.1 Operating Mode STOP

Usage



1. ▷



Use the STOP button to activate operating mode STOP.



Observe the notes on the system's reaction upon activation of operating mode STOP as listed below.



STOP LED is illuminated at the front panel; ToolKit home page shows STOP icon left beside the prime mover.

System reaction

In operating mode STOP neither the engine nor the GCB can be operated. Dependent on the application mode the power circuit breakers cannot be operated.

CAUTION!



Hazards due to improper use of operating mode STOP

Selecting the operating mode STOP is not the same as an EMERGENCY STOP.

In some cases the easYgen will perform additional logic functions, such as an engine cool down period, before the engine is stopped.

- For emergency stop functionality use an EMERGENCY STOP discrete input, programmed as an F class alarm.

If the operating mode STOP is selected while the engine was already stopped the following applies:

- The GCB will not be closed.
- The fuel solenoid relay will not be enabled.
- The start request is ignored.
- The start push buttons (softkeys) are disabled.
- The engine/generator monitoring remains activated (exception: all monitoring that is delayed by the engine speed).

If the operating mode STOP is selected while the engine was running the following applies:

- Dependent on the current application mode a soft shut down will be executed.
- Pressing the STOP button again opens the GCB.
- If the STOP button is pressed again, the cool down will be interrupted.

If the operating mode STOP is selected while the engine performs a cool down the following applies:

- Pressing the STOP button again causes an immediate stop of the cool down and stops the engine.

i

If the conditions of the LogicsManager function "Enable MCB" (parameter [12923](#)) are TRUE, the MCB will be closed again if it is open in STOP operating mode.

5.2.2 Operating Mode MANUAL

General usage

In the MANUAL operating mode (mode button »MAN« illuminated) both the engine circuit breaker and the power circuit breaker can be operated via the push buttons along the bottom of the display (softkeys). Additionally the Start(I)/Stop(O) buttons can be used to start or stop the engine.

Fig. 246: Buttons for manual operation

1	Mode button: MAN
2	START button: Engine
3	STOP button: Engine
4 .. 6	Soft buttons: Breaker OPEN/CLOSE

⚙️

1. ▷



Use the mode button »MAN« to activate operating mode MANUAL.

- ▶ The MAN button is illuminated

NOTICE!



The breakers will open immediately without power reduction.

To open the breaker in a no-load condition, reduce the load manually in the setpoints screen (↩️> "4.1.5 Specialized Menu Screens").

Example for application mode A01



> To start the engine:

- ▶  Press the button »|« below the MAN button.

- ▶ Success: The engine starts and the circular arrow and the eye symbol appear.
- ▶ Failure: No change in the display until the "start failure" message appears.







> To stop the engine:

- ▶  Press the button »0« right below the MAN button.

- ▶ Success: The engine stops and the circular arrow and the eye symbol disappear.
- ▶ Failure: No change in the display until the "stop failure" message appears.

Overview

Function Status	Symbol	Available in application mode												
		A01	A02	A03	A04	A05	A06	A07	A08	A09	A10	A11	A12	A13
Start running engine	 	✓	✓	✓	✓	✓	✓	✓	✓	✓	✓	✓	✓	✓
Stop stand still engine	 	✓	✓	✓	✓	✓	✓	✓	✓	✓	✓	✓	✓	✓
Breaker open command is issued or a closure of the			✓											

Function Status	Symbol	Available in application mode												
		A01	A02	A03	A04	A05	A06	A07	A08	A09	A10	A11	A12	A13
breaker is blocked														
No defined breaker state			✓											
Open the GCB				✓	✓	✓	✓	✓	✓	✓	✓	✓	✓	✓
Close the GCB				✓	✓	✓	✓	✓	✓	✓	✓	✓	✓	✓
Open the GGB ¹						✓	✓			✓	✓	✓	✓	
Close the GGB ¹						✓	✓			✓	✓	✓	✓	
Open the MCB					✓		✓		✓	✓		✓	✓	
Close the MCB					✓		✓		✓	✓		✓	✓	

 ¹ The GGB can not be operated via softkey.

Symbol	Description
	Generator or mains rotating field moves clockwise.
	Generator or mains rotating field moves counter-clockwise.
	Power is detected at the respective measuring point (generator, busbar, or mains).
	Indicates that the engine delayed monitoring has expired and the monitoring functions are enabled.
	Power is imported (at mains interchange).
	Power is exported (at mains interchange).

Table 105: Status symbols

5.2.3 Operating Mode AUTOMATIC

General usage

In the AUTOMATIC operating mode («AUTO»), all engine, GCB, and/or MCB functions are operated via an interface, or automatically by the control unit (i.e. a mains failure).



The function of the easYgen depends on the configuration of the unit and how the external signals are used.



1. ▷



Use the button »AUTO« to activate operating mode AUTOMATIC.



If mode change was successful the button »AUTO« is illuminated.



For a more detailed description of the start/stop sequence of the engine and the associated parameters refer to [↳ "4.4.5.2 Operation Mode AUTO - Automatic Run"](#).

The main functions are briefly described in the following sections.

Start engine

The engine is started via a remote start signal.

Prerequisites:

- The AUTOMATIC operating mode is enabled.
- The start request is enabled by the LogicsManager Start req. in AUTO.
- No shut down alarm is present. (for explanation of the alarm classes refer to [↳ "9.5.4 Alarm Classes"](#)).
- The engine is ready for operation.
- The GCB is open.

Auto mains failure operation (AMF)



Auto mains failure operation is available in application mode **A04**, **A06**, **A07**, **A08**, **A09**, **A11**, **A12** and **A13**.

If the AUTOMATIC operating mode is enabled and the mains fail, the engine and the power circuit breakers will be operated according to the current application mode.

Prerequisites:

- The AUTOMATIC operating mode is enabled.
- The parameter "Emergency power" is configured to "On".
- The configured mains failure limits are reached.
- The configured delay times have expired.

- No shut down alarm is present. (for explanation of the alarm classes refer to [9.5.4 Alarm Classes](#)).
- The engine is ready for operation.

5.2.4 Operating Mode TEST

General usage

The operating mode (»TEST«) usually is a temporary operating mode. The idea is to test the genset.

TEST operating mode always starts the engine, when changing into this mode independent on an AUTOMATIC start order. Additionally the TEST operating mode supports the emergency and critical run as well (if a mains failure occurs during the test run). The operating mode TEST supports different sub modes so the operator can choose if the breakers shall be closed during test run or whether the operating mode is changed after the test run.



The function of the easYgen depends on the configuration of the unit and how the external signals are used.



1. ▷



Use the button »TEST« to activate operating mode TEST.



If mode change was successful the button »TEST« is illuminated.



The illumination of the button becomes twinkling a short time before TEST run is over.



For a more detailed description of the start/stop sequence of the engine and the associated parameters refer to [4.4.5.3 Operation Mode TEST](#).

The main functions are briefly described in the following sections.

5.3 Restore Language Setting via HMI, Buttons and Softkeys



- > In order to change the language setting via HMI, press the (soft)keys in the following order:



Language parameter is on code level "0", so the instruction will work with each code level.

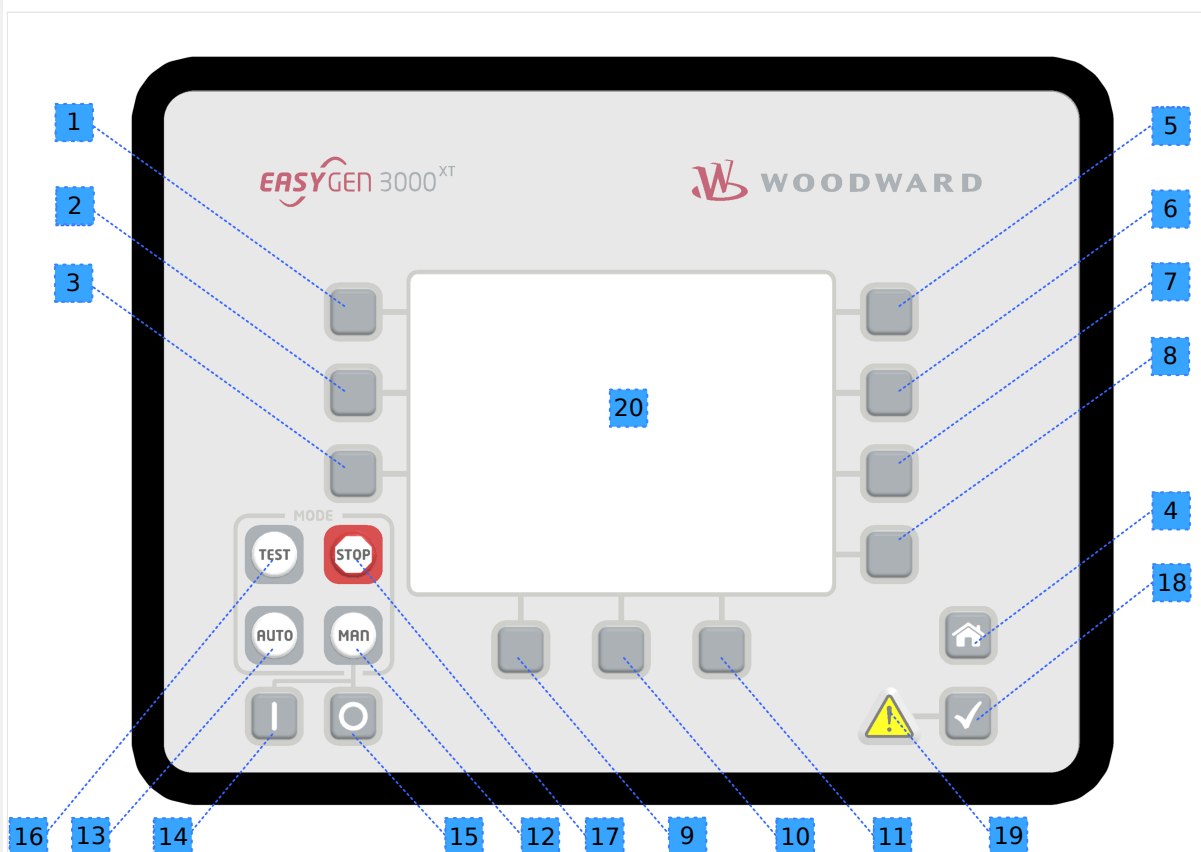

Fig. 247: Front panel and display

1. ▷ Press button »HOME« once to return to the start screen
2. ▷ Press softkey »6« once to access the "Parameter" screen
3. ▷ Press softkey »3« once to access the "Configure language / clock" screen
4. ▷ Press softkey »7« once to edit the language setting
5. ▷ Press softkeys »11« or »12« to select the desired language.
6. ▷ Press softkey »7« once to commit the language setting.
- ▶ The desired display language is restored.

6 Application Field

Device status

The following applications are described for devices with status "factory settings". This is mandatory because parameters not changed during sample setup may have influence to the devices' behavior!



Live test requirement

If you want to use the same setup as described with the sample, please ensure factory settings status of the device before changing it.

Otherwise you have to take care that the changes you did before do not "disturb" sample settings!



Application Modes

For application modes overview see chapter [↪ "2.2 Application Modes Overview"](#).

6.1 Basic Applications

6.1.1 Application mode A01 (None)

This application mode (**A01**) may be used, where the breaker control is done external. In this case, the easYgen will function as an engine control with generator and engine protection. The control does not operate any breaker. Emergency mode (AMF operation) is not supported in this application mode.

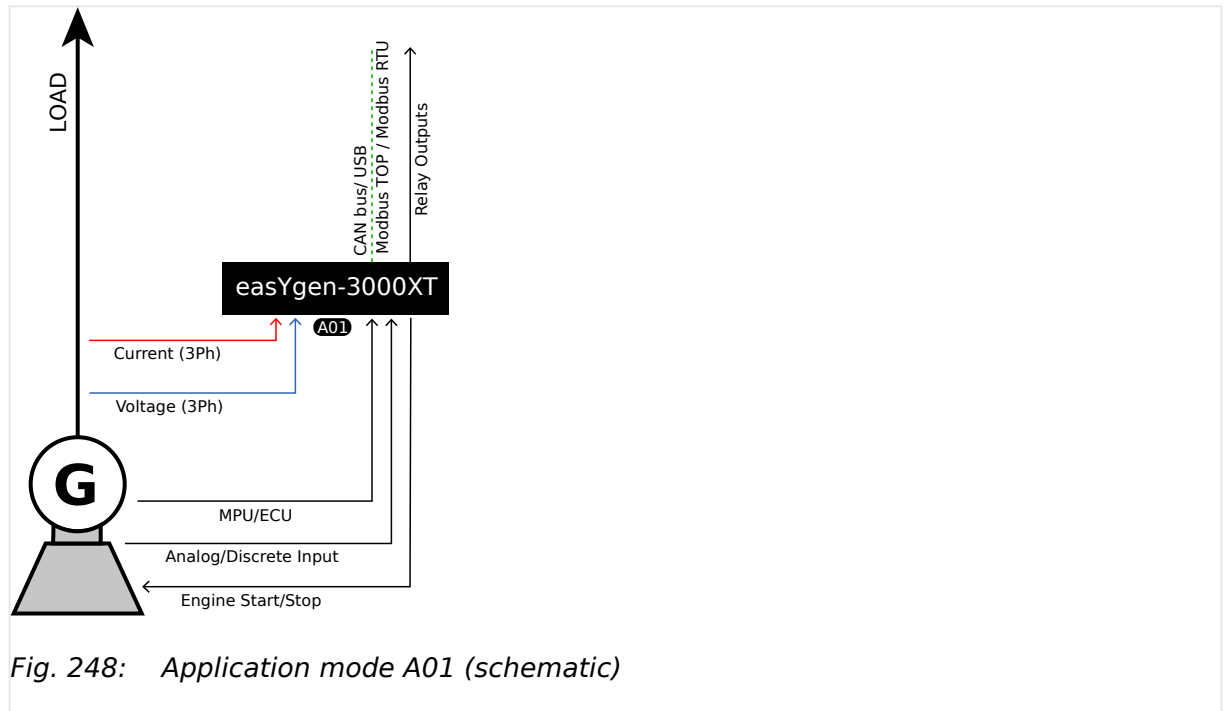

Fig. 248: Application mode A01 (schematic)



The easYgen requires the feedback reply from GCB and MCB in this application mode. These replies are used to define, whether the easYgen controls frequency, shares the load with other gensets or performs active load control.

The following feedback signals are used in this application mode and fixed to the respective discrete inputs:

- DI 7 "Reply MCB" (mains parallel)
- DI 8 "Reply GCB" (normally closed (break) contact)



If the easYgen is intended to be operated in parallel with the mains, the mains voltage measuring inputs must be connected.

If an external mains decoupling is performed, jumpers between busbar and mains voltage measuring inputs may be installed.

Engine operation in AUTOMATIC (basic function)

Engine starts, if

- The LogicsManager "86.09 LM: Start req.in AUTO" is fulfilled (TRUE) AND
- A shut down alarm is not present AND
- The engine is ready for operation

Engine stops, if

- The reply GCB is open AND the LogicsManager "86.09 LM: Start req.in AUTO" is not fulfilled (FALSE) OR
- A shut down alarm occurs

Being parallel to mains or to other generator, the generator power will be reduced before.



Refer to [↪ "4.4.5.2 Operation Mode AUTO - Automatic Run"](#) for details.

6.1.2 Application mode A02 (GCB open)

This application mode (**A02**) may be used for islanded operation applications.

In this case, the easYgen will function as an engine control with generator and engine protection. The control unit can only open the GCB. Emergency mode (AMF operation) is not supported in this application mode.

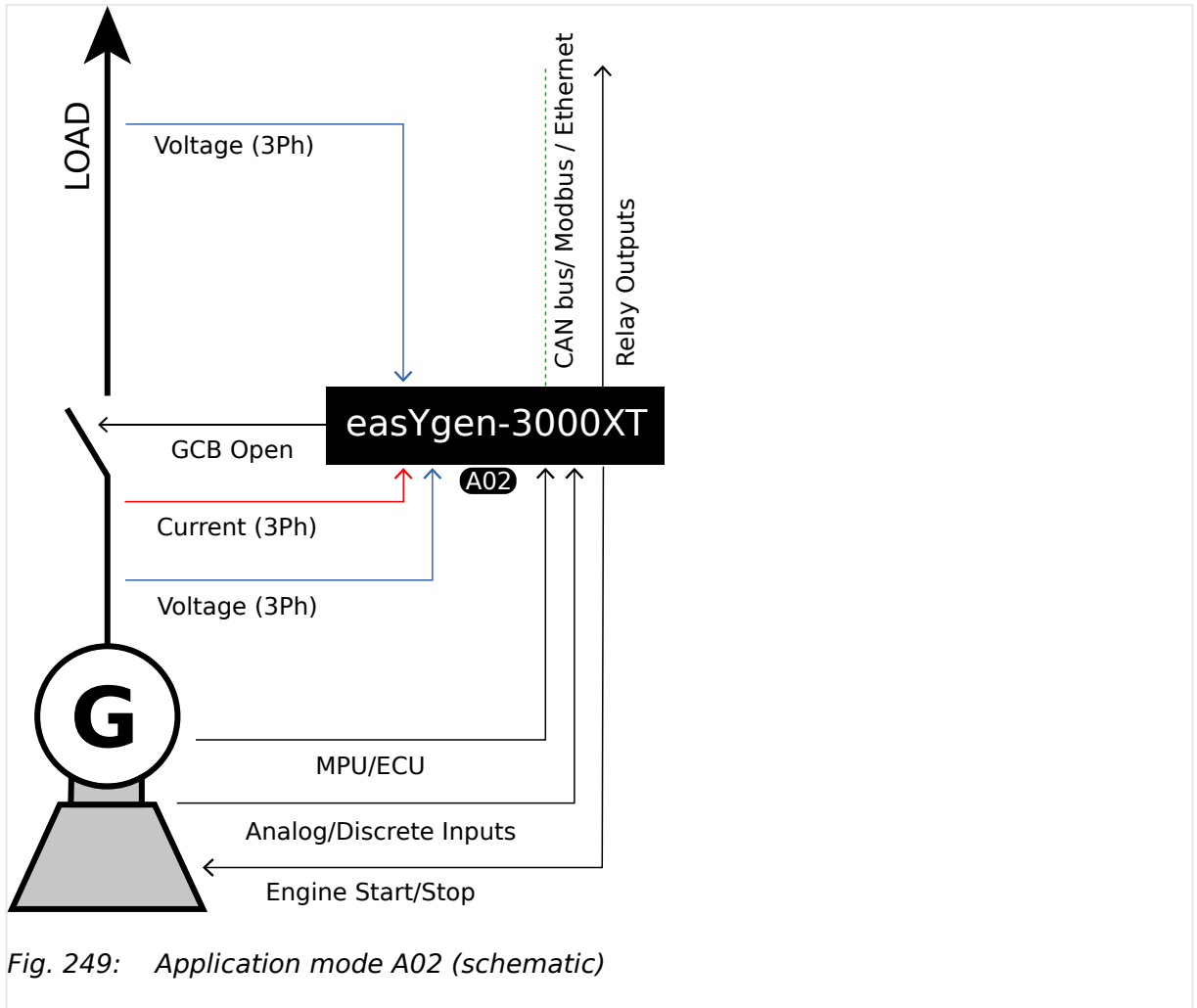

Fig. 249: Application mode A02 (schematic)



The easYgen requires the feedback reply from GCB and MCB in this application mode. These replies are used to define, whether the easYgen controls frequency, shares the load with other gensets or performs active load control.

The following feedback signals and commands are used in this application mode and fixed to the respective discrete inputs and outputs:

- DI 7 "Reply MCB" (mains parallel)
- DI 8 "Reply GCB" (normally closed (break) contact)
- DO 7 "Command: GCB open"



If the easYgen is intended to be operated in parallel with the mains, the mains voltage measuring inputs must be connected.

If an external mains decoupling is performed, jumpers between busbar and mains voltage measuring inputs may be installed.

Engine operation in AUTOMATIC (basic function)

Engine starts, if

- The LogicsManager "86.09 LM: Start req.in AUTO" is fulfilled (TRUE) AND

- A shut down alarm is not present AND
- The engine is ready for operation

With successful start the GCB closure is released.

Engine stops, if

- The reply GCB is open AND the LogicsManager "86.09 LM: Start req.in AUTO" is not fulfilled (FALSE) OR
- A shut down alarm occurs

Being parallel to mains or to other generator, the generator power will be reduced before.



Refer to [4.4.5.2 Operation Mode AUTO - Automatic Run](#) for details.

6.1.3 Application mode A03 (GCB)

This application mode (**A03**) may be used in applications, where only the GCB is operated by the easYgen.

If it is used for islanded or mains parallel operations, mains decoupling should be performed by the GCB or an external provision.

The easYgen will function as an engine control with generator and engine protection. The control unit can open and close the GCB. Emergency mode (AMF operation) is not supported in this application mode.

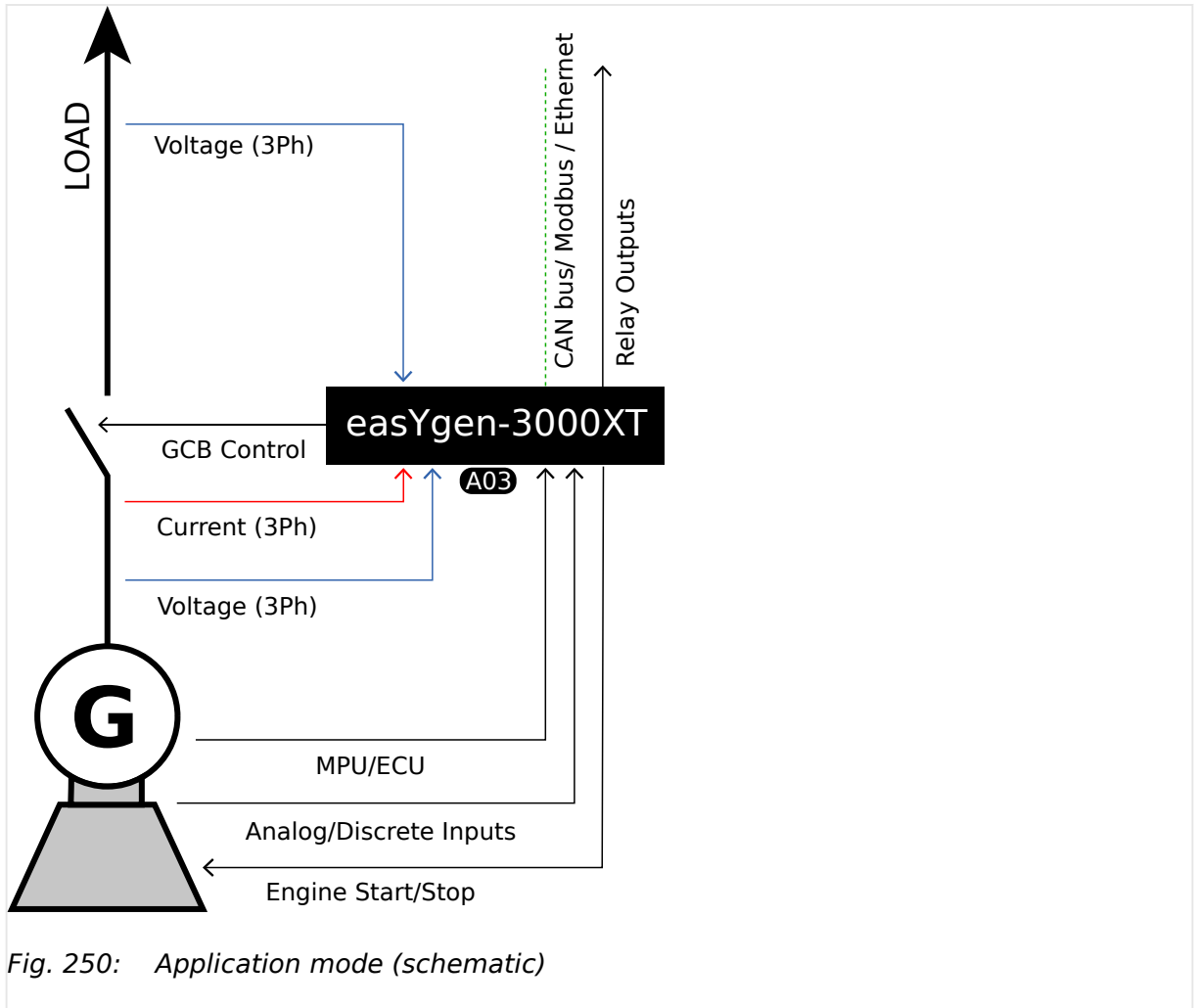

Fig. 250: Application mode (schematic)



The easYgen requires the feedback reply from GCB and MCB in this application mode. These replies are used to define, whether the easYgen controls frequency, shares the load with other gensets or performs active load control.

The following feedback signals and commands are used in this application mode and fixed to the respective discrete inputs and outputs:

- DI 7 "Reply MCB" (mains parallel)
- DI 8 "Reply GCB" (normally closed (break) contact)
- DO 6 "Command: GCB close"
- DO 7 "Command: GCB open" (optionally)



If the easYgen is intended to be operated in parallel with the mains, the mains voltage measuring inputs must be connected.

If an external mains decoupling is performed, jumpers between busbar and mains voltage measuring inputs may be installed.

Engine operation in AUTOMATIC (basic function)

Engine starts, if

- The LogicsManager "86.09 LM: Start req.in AUTO" is fulfilled (TRUE) AND
- A shut down alarm is not present AND
- The engine is ready for operation

With successful start the GCB closure is executed.

- If the voltage of generator and generator busbar is in range, the GCB will be synchronized



If the voltage of generator is in range, and the **generator busbar** is dead, and no other GCB is closed, **and the MCB is closed** the GCB will **not** be closed but an »operating range failure« occurs.

Engine stops, if

- The LogicsManager "86.09 LM: Start req.in AUTO" is not fulfilled (FALSE) OR
- A shut down alarm occurs

Being parallel to mains or to other generator, the generator power will be reduced, before the GCB will be opened.



Refer to [↪ "4.4.5.2 Operation Mode AUTO - Automatic Run"](#) for details.

6.1.4 Application mode A04 (GCB/MCB)

This application mode (**A04**) may be used for mains parallel operation. In this case, the easYgen will function as an engine control with generator, mains and engine protection.

The control unit can open and close the GCB and the MCB. The breaker transition modes "Open Transition", "Closed Transit.", "Interchange" and "Parallel" are possible.

The Emergency mode (AMF operation) is supported in this application mode.

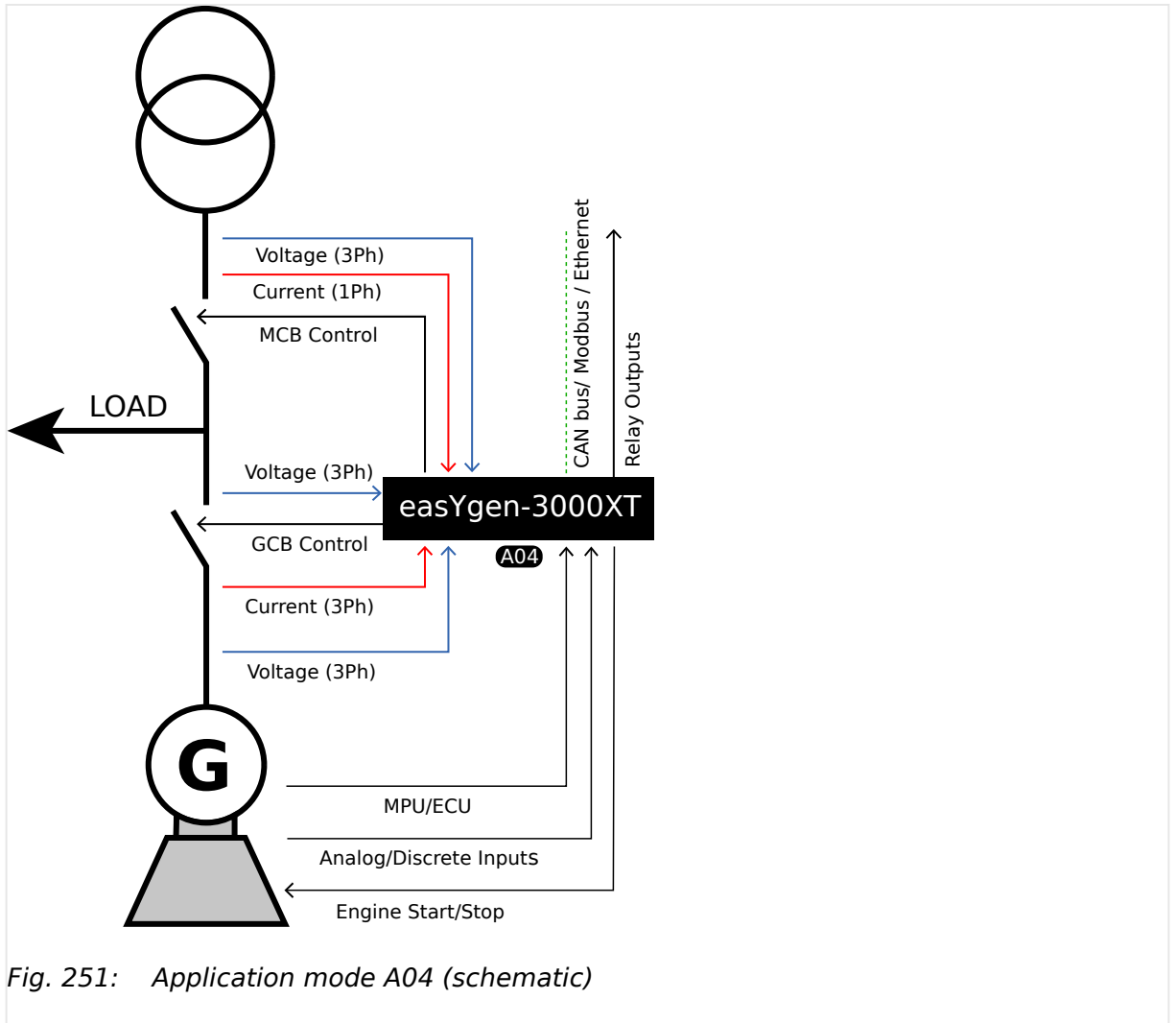

Fig. 251: Application mode A04 (schematic)



The easYgen requires the feedback reply from both circuit breakers in this application mode. These replies are used to define, whether the easYgen controls frequency, shares the load with other gensets or performs active load control.

The following feedback signals and commands are used in this application mode and fixed to the respective discrete inputs and outputs:

- DI 7 "Reply MCB" (mains parallel)
- DI 8 "Reply GCB" (normally closed (break) contact)
- DO 6 "Command: GCB close"
- DO 7 "Command: GCB open" (optionally)
- DO 8 "Command: MCB close"
- DO 9 "Command: MCB open"

Engine operation in AUTOMATIC (basic function)

Engine starts, if

- The LogicsManager "86.09 LM: Start req.in AUTO" is fulfilled (TRUE) AND

- A shut down alarm is not present AND
- The engine is ready for operation

According to the current active breaker transition mode the GCB and MCB will be operated.

Engine stops, if

- The LogicsManager "86.09 LM: Start req.in AUTO" is not fulfilled (FALSE) OR
- A shut down alarm occurs

According to the current active breaker transition mode the GCB and MCB will be operated.



Refer to [4.4.5.2 Operation Mode AUTO - Automatic Run](#) for details.

Auto mains failure operation (AMF) in AUTOMATIC (basic function)

Engine starts, if

- The configured mains failure limits are reached AND
- A shut down alarm is not present AND
- The engine is ready for operation

With successful start the MCB will be opened and the GCB will be closed.

Engine stops, if

- The mains values are back in range AND
- The mains settling time is expired

According to the current active breaker transition mode the GCB and MCB will be operated.

6.1.5 Application mode A05 (GCB/GGB)

This application mode (**A05**) may be used in applications, where a common generator group breaker connects the generator busbar with the load. The GGB is closed, if a configured generator power is available. Depending on the GGB mode "ID3422", the GGB will be opened or kept closed. The application can be an isolated operation or a parallel to mains operation.

In this case, the easYgen will function as an engine control with generator, mains and engine protection. The control unit can open and close the GCB and the GGB.

The Emergency mode (AMF operation) is not supported in this application.

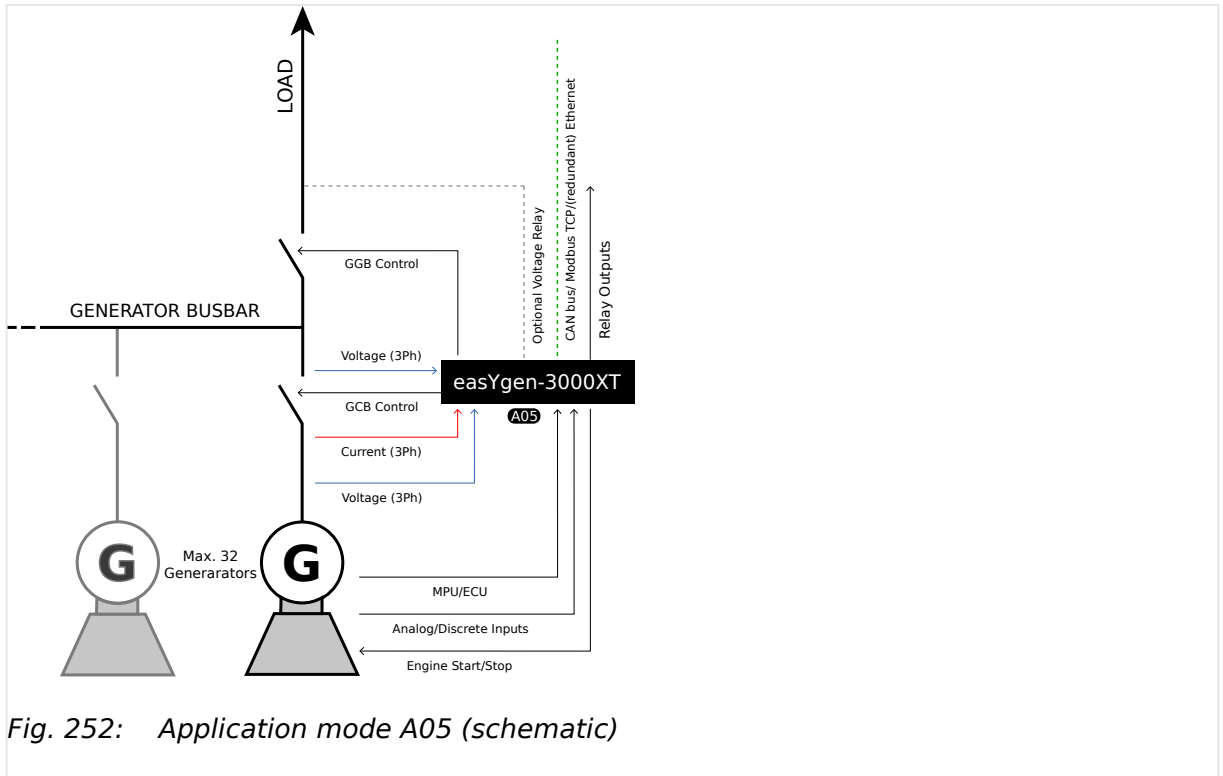

Fig. 252: Application mode A05 (schematic)

i The easYgen requires the feedback reply from the GCB, GGB and MCB in this application mode. Load busbar connected to mains is signaled as “reply MCB”. These replies are used to define, whether the easYgen controls frequency, shares the load with other gensets or performs active load control.

The following feedback signals and commands are used in this application mode and fixed to the respective discrete inputs and outputs:

- DI 7 "Reply MCB" (mains parallel)
- DI 8 "Reply GCB" (normally closed (break) contact)
- DO 6 "Command: GCB close"
- DO 7 "Command: GCB open"
- DO 10 "Command: GGB close"
- DO 11 "Command: GGB open"

Engine operation in AUTOMATIC (basic function)

Engine starts, if

- The LogicsManager "86.09 LM: Start req.in AUTO" is fulfilled (TRUE) AND
- A shut down alarm is not present AND
- The engine is ready for operation

With successful start the GCB closure is executed.

- If the voltage of generator and generator busbar is in range, the GCB will be synchronized

- If the voltage of generator is in range and the **generator busbar** is dead and no other GCB is closed, the GCB will be closed

With configured generator power matched, the GGB closure is executed.

- If the voltage of generator and load busbar is in range the GGB will be synchronized
- If the voltage of generator is in range and the **load busbar** is dead, the GGB will be closed

Engine stops, if

- The LogicsManager "86.09 LM: Start req.in AUTO" is not fulfilled (FALSE) OR
- A shut down alarm occurs

Being parallel to mains or to other generator, the own generator power will be reduced, before the GCB will be opened.

Depending on the GGB mode "ID3422", the GGB will be opened or kept closed.



Refer to [↳ "4.4.5.2 Operation Mode AUTO - Automatic Run"](#) for details.

6.1.6 Application mode A06 (GCB/GGB/MCB)

This application mode (**A06**) may be used for mains parallel operation, where a common generator group breaker connects the generator busbar with the load. In this case, the easYgen will function as an engine control with generator, mains and engine protection.

The control unit can open and close the GCB, GGB and the MCB. The GGB is closed, if a configured generator power is available. Depending on the GGB mode "ID3422", the GGB will be opened or kept closed. The breaker transition modes "Open Transition", "Closed Transit.", "Interchange" and "Parallel" are possible.

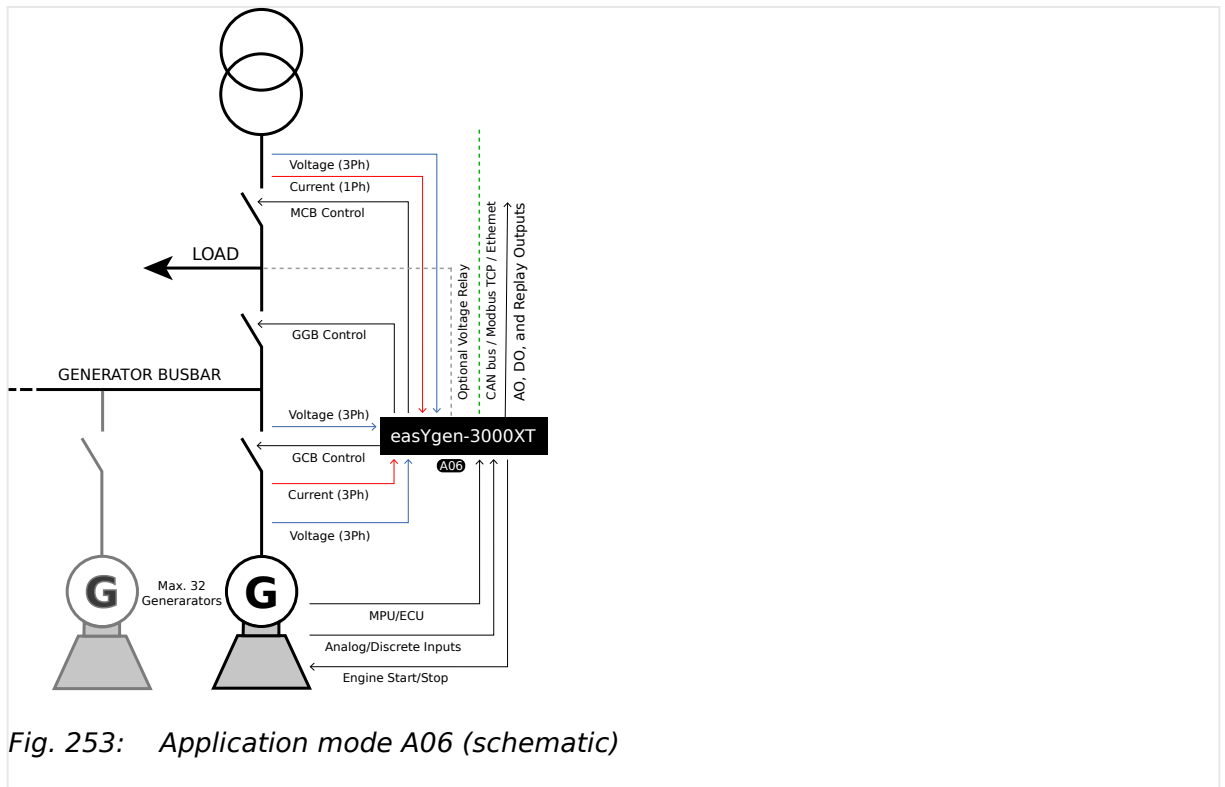

Fig. 253: Application mode A06 (schematic)



The easYgen requires the feedback reply from GCB, GGB and MCB in this application mode. These replies are used to define, whether the easYgen controls frequency, shares the load with other gensets or performs active load control.

The following feedback signals and commands are used in this application mode and fixed to the respective discrete inputs and outputs:

- DI 7 "Reply MCB" (mains parallel)
- DI 8 "Reply GCB" (normally closed (break) contact)
- DI 9 "Reply GGB" (normally closed (break) contact)
- DO 6 "Command: GCB close"
- DO 7 "Command: GCB open" (optionally)
- DO 8 "Command: MCB close"
- DO 9 "Command: MCB open"
- DO 10 "Command: GGB close"
- DO 11 "Command: GGB open"

Engine operation in AUTOMATIC (basic function)

Engine starts, if

- The LogicsManager "86.09 LM: Start req.in AUTO" is fulfilled (TRUE) AND
- A shut down alarm is not present AND

- The engine is ready for operation

With successful start the GCB closure is executed.

- If the voltage of generator and generator busbar is in range, the GCB will be synchronized
- If the voltage of generator is in range and the **generator busbar** is dead and no other GCB is closed, the GCB will be closed

With configured generator power matched, the GGB and MCB will be operated according to the current active breaker transition mode.

Engine stops, if

- The LogicsManager "86.09 LM: Start req.in AUTO" is not fulfilled (FALSE) OR
- A shut down alarm occurs

If all units stopped to the same time, the load will be transferred back to mains according to the current active breaker transition mode.

Being parallel to mains or to other generator, the own generator power will be reduced, before the GCB will be opened.

Depending on the GGB mode "ID3422", the GGB will be opened or kept closed.



Refer to [↳ "4.4.5.2 Operation Mode AUTO - Automatic Run"](#) for details.

Auto mains failure operation (AMF) in AUTOMATIC (basic function)

Engine starts, if

- The configured mains failure limits are reached AND
- A shut down alarm is not present AND
- The engine is ready for operation

With successful start the GCB closure is executed.

- If the voltage of generator and generator busbar is in range, the GCB will be synchronized
- If the voltage of generator is in range and the **generator busbar** is dead, no other GCB is closed and the GGB is open, the GCB will be closed

With configured generator power matched, the GGB and MCB will be operated according to the current active breaker transition mode.

Engine stops, if

- The mains values are back in range AND
- The mains settling time is expired

The load will be transferred back to mains according to the current active breaker transition mode.

Depending on the GGB mode "ID3422", the GGB will be opened or kept closed.

6.1.7 Application mode A07 (GCB/LSx)

Note Unless otherwise noted, "LS-5", "LSx", "LS-6XT" and "easYgen|LS-6XT" are used interchangeably in this document.

This application mode (**A07**) may be used in LSx **Layer 1** applications (without Group Controller), where several breakers as incoming mains breaker, generator group breaker or tie breaker must be operated. In this case, the easYgen will function as an engine control with generator and engine protection.

For a description of the different layers (Layer 1, Layer 2 and Layer 3) see Application mode GCB/GC **A13** [↪ "6.1.13 Application mode A13 \(GCB/GC\)"](#).

The control unit can open and close the GCB. The CAN connected LSx system operates all other breakers in the system. The application can be an isolated operation or a parallel to mains operation. The LS-5 system runs independent on the easYgen (Application mode "LSx"). The mains protection (mains decoupling) is executed by the LSx at the interchange point(s).

The Emergency mode (AMF operation) is supported and depends on configured segments which are monitored for "out of operating range". The LSx at the interchange point can provide the easYgen with active power and reactive power measurement.

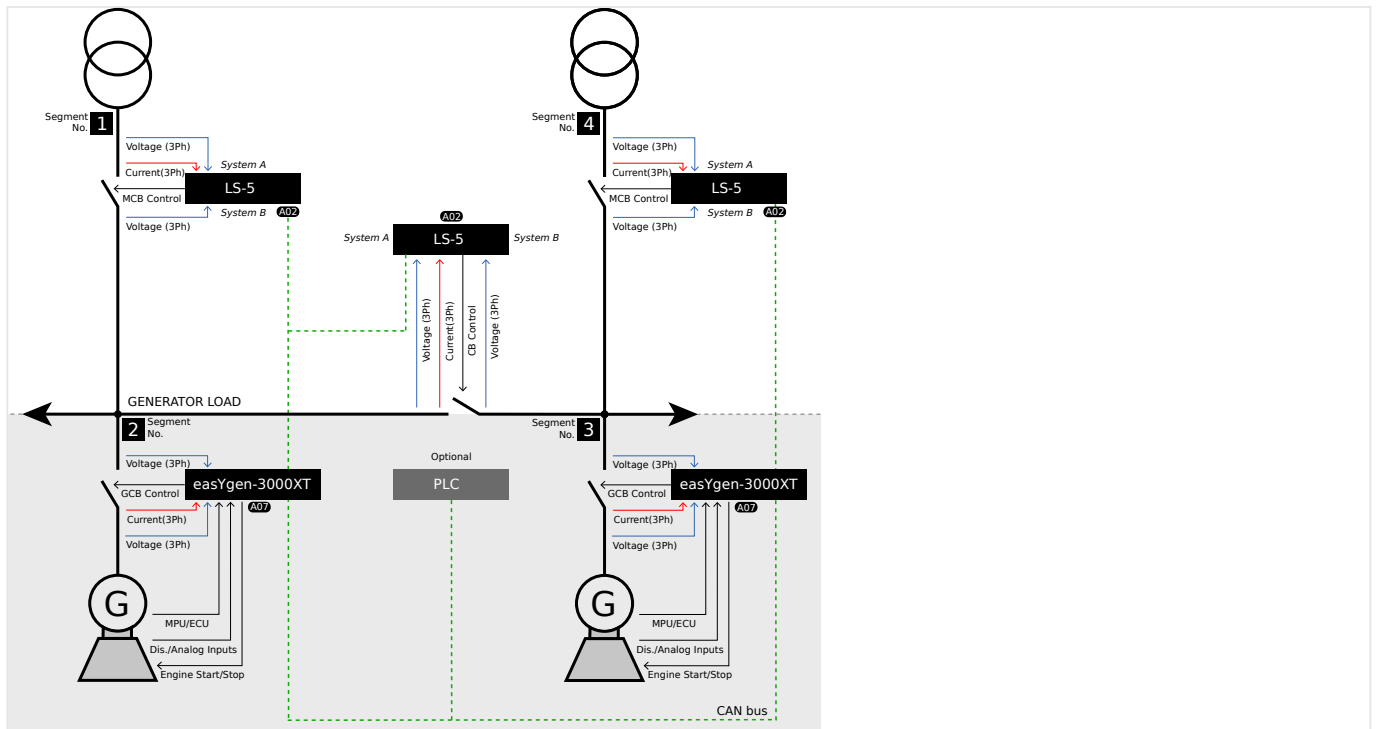

Fig. 254: Application mode A07 (schematic)

i Please note that the measured power of all LSx in the same segment are accumulated if there a several mains interchange points. The import/export control is based on this accumulated power. It is not possible to individually control the power at the single mains interchange points in the same segment.



The easYgen requires only the feedback reply from the GCB in this application mode. The other breaker replies are connected at the particular LSx. The LSx system informs the easYgen so, that the easYgen can control frequency, share load with other gensets or perform active load control.

The following feedback signals and commands are used in this application mode and fixed to the respective discrete inputs and outputs:

- DI 8 "Reply GCB" (normally closed (break) contact)
- DO 6 "Command: GCB close"
- DO 7 "Command: GCB open" (optionally)



If a mains decoupling shall be executed via GCB, the mains measurement must be wired to the easYgen.



Refer to the LS-5 / LS-6XT manuals for details on the easYgen/LSx system configuration.

Engine operation in AUTOMATIC (basic function)

Engine starts, if

- The LogicsManager "86.09 LM: Start req.in AUTO" is fulfilled (TRUE) AND
- A shut down alarm is not present AND
- The engine is ready for operation

With successful start the GCB closure is executed.

- If the voltage of generator and generator busbar is in range, the GCB will be synchronized
- If the voltage of generator is in range and the **generator busbar** is dead and no other GCB is closed, the GCB will be closed

Engine stops, if

- The LogicsManager 86.09 LM: Start req.in AUTO is not fulfilled (FALSE) OR
- A shut down alarm occurs

Being parallel to mains or to other generator, the generator power will be reduced, before the GCB will be opened.



Refer to [↪ "4.4.5.2 Operation Mode AUTO - Automatic Run"](#) for details.

Auto mains failure operation (AMF) in AUTOMATIC (basic function)

Engine starts, if

- Minimum one configured segment is out of range AND
- A shut down alarm is not present AND
- The engine is ready for operation

With successful start the GCB closure is executed.¹

- If the voltage of generator and generator busbar is in range, the GCB will be synchronized
- If the voltage of generator is in range and the **generator busbar** is dead, no other GCB is closed and the generator busbar is not connected to mains, the GCB will be closed

Engine stops, if

- The mains values are back in range AND
- The mains settling time is expired²

The generator power will be reduced, before the GCB will be opened.



¹ The LSx at the interchange point has to open the MCB, if the mains fail.

² The mains settling time runs in the LSx at the interchange point. The easYgen indicates a running mains settling time.

6.1.8 Application mode A08 (GCB/L-MCB)

This application mode (**A08**) may be used for mains parallel operation. In this case, the easYgen will function as an engine control with generator and engine protection.

The control unit can open and close the GCB. The easYgen operates the MCB with a LS-5 unit, running in a slave mode (application mode “<y.textvar name=""/>L-MCB”). The breaker transition modes “Open Transition”, “Closed Transit.”, “Interchange” and “Parallel” are possible.

The Emergency mode (AMF operation) is supported in this application mode. The LS-5 can provide the easYgen with active power and reactive power measurement.

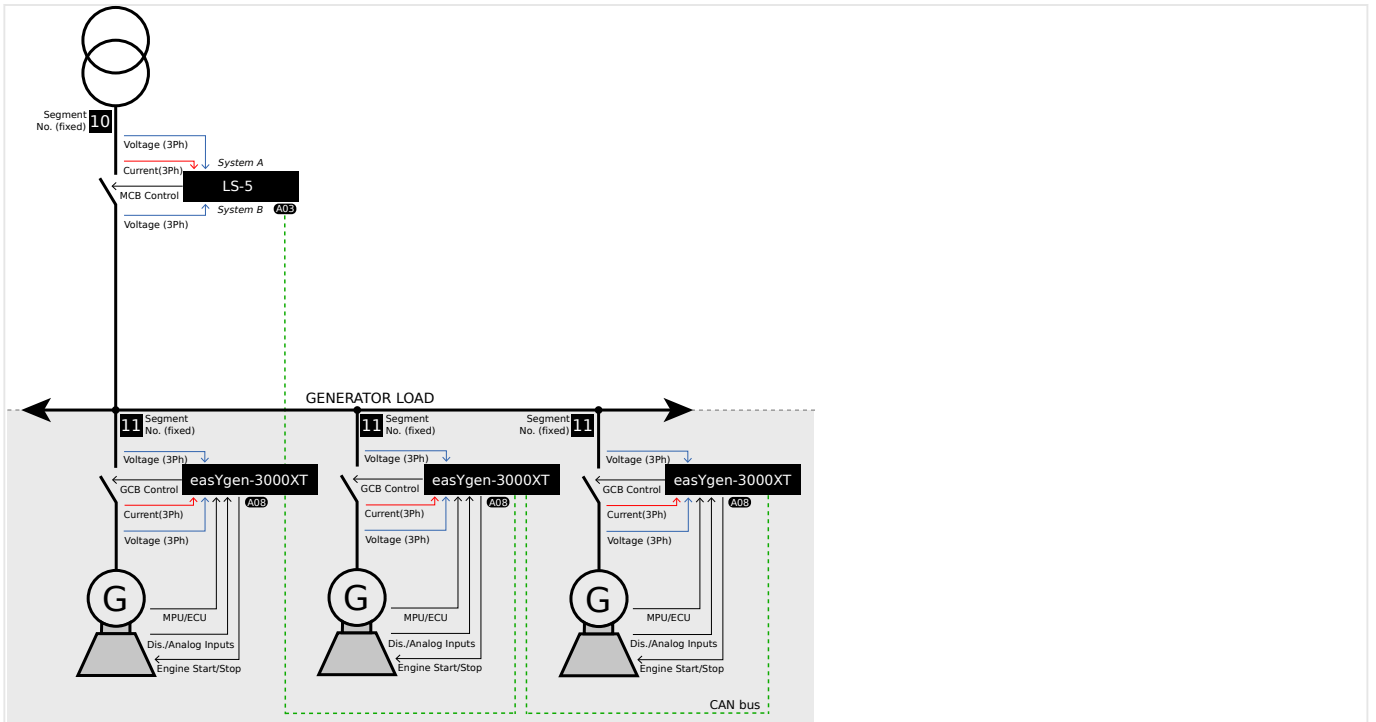

Fig. 255: Application mode A08 (schematic)



The easYgen requires only the feedback reply from the GCB in this application mode. The MCB feedback reply is connected at the LS-5. The LS-5 informs the easYgen so, that the easYgen(s) can control frequency, share load with other gensets or perform active load control.

The following feedback signals and commands are used in this application mode and fixed to the respective discrete inputs and outputs:

- DI 8 "Reply GCB" (normally closed (break) contact)
- DO 6 "Command: GCB close"
- DO 7 "Command: GCB open" (optionally)



If a mains decoupling shall be executed via GCB, the mains measurement must be wired to the easYgen.



Refer to the LS-5 / LS-6XT manuals for details on the easYgen/LSx system configuration.

Engine operation in AUTOMATIC (basic function)

Engine starts, if

- The LogicsManager 86.09 LM: Start req.in AUTO is fulfilled (TRUE) AND
- A shut down alarm is not present AND

- The engine is ready for operation

According to the current active breaker transition mode the GCB and MCB will be operated.¹

Engine stops, if

- The LogicsManager 86.09 LM: Start req.in AUTO is not fulfilled (FALSE) OR
- A shut down alarm occurs

According to the current active breaker transition mode the GCB and MCB will be operated.



Refer to [↪ “4.4.5.2 Operation Mode AUTO - Automatic Run”](#) for details.

Auto mains failure operation (AMF) in AUTOMATIC (basic function)

Engine starts, if

- The configured mains failure limits are reached AND²
- A shut down alarm is not present AND
- The engine is ready for operation

With successful start the MCB will be opened and the GCB will be closed.

Engine stops, if

- The mains values are back in range AND²
- The mains settling time is expired³

According to the current active breaker transition mode the GCB and MCB will be operated.



¹ The MCB is operated by the LS-5. The LS-5 itself must be free of any alarm class C and E.

² The mains failure limits are configured in the LS-5 (operating range system A).

³ The mains settling time runs in the LS-5 at the interchange point. The easYgen indicates a running mains settling time.

6.1.9 Application mode A09 (GCB/GGB/L-MCB)

This application mode (**A09**) may be used for mains parallel operation, where a common GGB shall be operated by the easYgen and a MCB shall be operated far away. In this case, the easYgen will function as an engine control with generator and engine protection.

The control unit can open and close the GCB and the GGB. The GGB is closed, if a configured generator power is available. Depending on the GGB mode "ID3422", the GGB will be opened or kept closed. The breaker transition modes "Open Transition", "Closed

Transit.", "Interchange" and "Parallel" are possible. The easYgen operates the MCB with a LS-5 unit, running in a slave mode (application mode "L-MCB"). The mains protection (mains decoupling) is executed by the LS-5.

The Emergency mode (AMF operation) is supported in this application mode. The LS-5 can provide the easYgen(s) with active power and reactive power measurement.

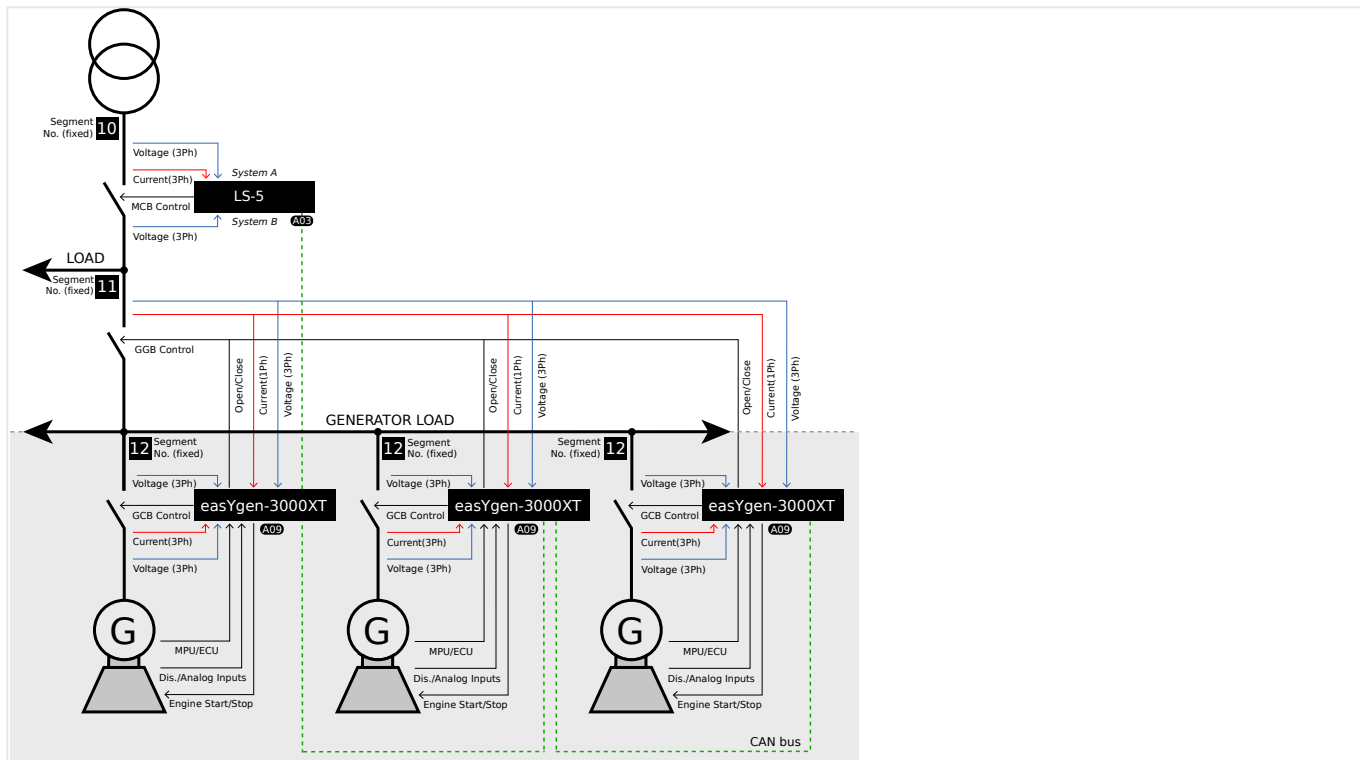

Fig. 256: Application mode A09 (schematic)



The easYgen requires the feedback reply from the GCB and GGB in this application mode. The MCB feedback reply is connected at the LS-5. The LS-5 informs the easYgen so, that the easYgen(s) can control frequency, share load with other gensets or perform active load control.

The following feedback signals and commands are used in this application mode and fixed to the respective discrete inputs and outputs:

- DI 8 "Reply GCB" (normally closed (break) contact)
- DI 9 "Reply GGB" (normally closed (break) contact)
- DO 6 "Command: GCB close"
- DO 7 "Command: GCB open" (optionally)
- DO 10 "Command: GGB close"
- DO 11 "Command: GGB open"



The easYgen uses in this application mode the mains voltage measuring to measure the load busbar voltage. All measured values shown as "mains" voltage are here in real the load busbar.



If a mains decoupling shall be executed via GCB, the mains measurement must be wired to the easYgen.



Refer to LS-5 / LS-6XT manuals for details on the easYgen/LS-5 system configuration.

Engine operation in AUTOMATIC (basic function)

Engine starts, if

- The LogicsManager 86.09 LM: Start req.in AUTO is fulfilled (TRUE) AND
- A shut down alarm is not present AND
- The engine is ready for operation

With successful start the GCB closure is executed.

- If the voltage of generator and generator busbar is in range, the GCB will be synchronized
- If the voltage of generator is in range and the **generator busbar** is dead, no other GCB is closed and the GGB is open, the GCB will be closed

With configured generator power matched, the GGB and MCB will be operated according to the current active breaker transition mode.¹

Engine stops, if

- The LogicsManager 86.09 LM: Start req.in AUTO is not fulfilled (FALSE) OR
- A shut down alarm occurs

If all units stopped to the same time, the load will be transferred back to mains according to the current active breaker transition mode.

Being parallel to mains or to other generator, the own generator power will be reduced, before the GCB will be opened.

Depending on the GGB mode "ID3422", the GGB will be opened or kept closed.



Refer to [↪ "4.4.5.2 Operation Mode AUTO - Automatic Run"](#) for details.

Auto mains failure operation (AMF) in AUTOMATIC (basic function)

Engine starts, if

- The configured mains failure limits are reached AND²
- A shut down alarm is not present AND
- The engine is ready for operation

With successful start the GCB closure is executed.

- If the voltage of generator and generator busbar is in range, the GCB will be synchronized
- If the voltage of generator is in range and the **generator busbar** is dead, no other GCB is closed and the GGB is open, the GCB will be closed

With configured generator power matched, the GGB and MCB will be operated according to the current active breaker transition mode.

Engine stops, if

- The mains values are back in range AND²
- The mains settling time is expired³

The load will be transferred back to mains according to the current active breaker transition mode.

Depending on the GGB mode "ID3422", the GGB will be opened or kept closed.



¹ The MCB is operated by the LS-5. The LS-5 itself must be free of any alarm class C and E.

² The mains failure limits are configured in the LS-5 (operating range system A).

³ The mains settling time runs in the LS-5 at the interchange point. The easYgen indicates a running mains settling time.

6.1.10 Application mode A10 (GCB/L-GGB)

This application mode (**A10**) may be used in applications, where a common generator group breaker connects the generator busbar with the load. In this case, the easYgen will function as an engine control with generator and engine protection.

The control unit can open and close the GCB. The easYgen operates the GGB with a LS-5 unit, running in a slave mode (application mode "L-GGB"). The GGB is closed, if a configured generator power is available. The GGB opens, if the last GCB is opened. The application must be an isolated operation.

The Emergency mode (AMF operation) is not supported in this application mode.



This application mode supports only single- or multiple generators, which run permanent in isolated operation.

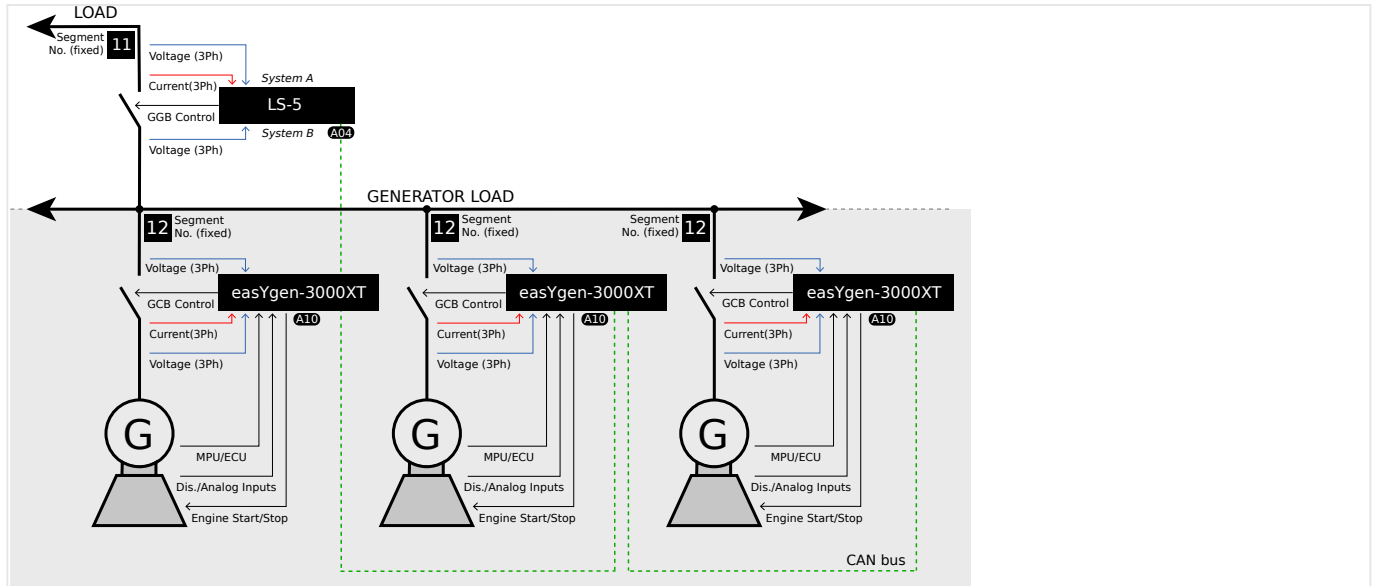

Fig. 257: Application mode A10 (schematic)

i The easYgen requires the feedback reply of the GCB and GGB in this application mode. These replies are used to define, whether the easYgen controls frequency or shares the load.

The following feedback signals and commands are used in this application mode and fixed to the respective discrete inputs and outputs:

- DI 8 "Reply GCB" (normally closed (break) contact)
- DO 6 "Command: GCB close"
- DO 7 "Command: GCB open" (optionally)

i Refer to the LS-5 / LS-6XT manuals for details on the easYgen/LS-5 system configuration.

Engine operation in AUTOMATIC (basic function)

Engine starts, if

- The LogicsManager 86.09 LM: Start req.in AUTO is fulfilled (TRUE) AND
- A shut down alarm is not present AND
- The engine is ready for operation

With successful start the GCB closure is executed.

- If the voltage of generator and generator busbar is in range, the GCB will be synchronized
- If the voltage of generator is in range and the **generator busbar** is dead and no other GCB is closed, the GCB will be closed

With configured generator power matched, the GGB closure is executed.

Engine stops, if

- The LogicsManager 86.09 LM: Start req.in AUTO is not fulfilled (FALSE) OR
- A shut down alarm occurs

Being parallel to mains or to other generator, the generator power will be reduced, before the GCB will be opened.

The GGB will be opened, if no GCB is closed anymore.



Refer to [↪](#) “4.4.5.2 Operation Mode AUTO - Automatic Run” for details.

6.1.11 Application mode A11 (GCB/L-GGB/L-MCB)

This application mode (**A11**) may be used for mains parallel operation, where a common GGB and a MCB shall be operated by LS-5. In this case, the easYgen will function as an engine control with generator and engine protection.

The control unit can open and close the GCB. The GGB is closed, if a configured generator power is available. The GGB opens, if the last GCB is opened. The breaker transition modes “Open Transition”, “Closed Transit.”, “Interchange” and “Parallel” are possible.. The easYgen operates the GGB with a LS-5 unit, running in a slave mode (application mode “L-GGB”). The easYgen operates the MCB with a LS-5 unit, running in a slave mode (application mode “L-MCB”). The mains protection (mains decoupling) is executed by the LS-5 of the MCB.

The Emergency mode (AMF operation) is supported in this application mode. The LS-5 of the MCB can provide the easYgen with active power and reactive power measurement.

6 Application Field

6.1.11 Application mode A11 (GCB/L-GGB/L-MCB)

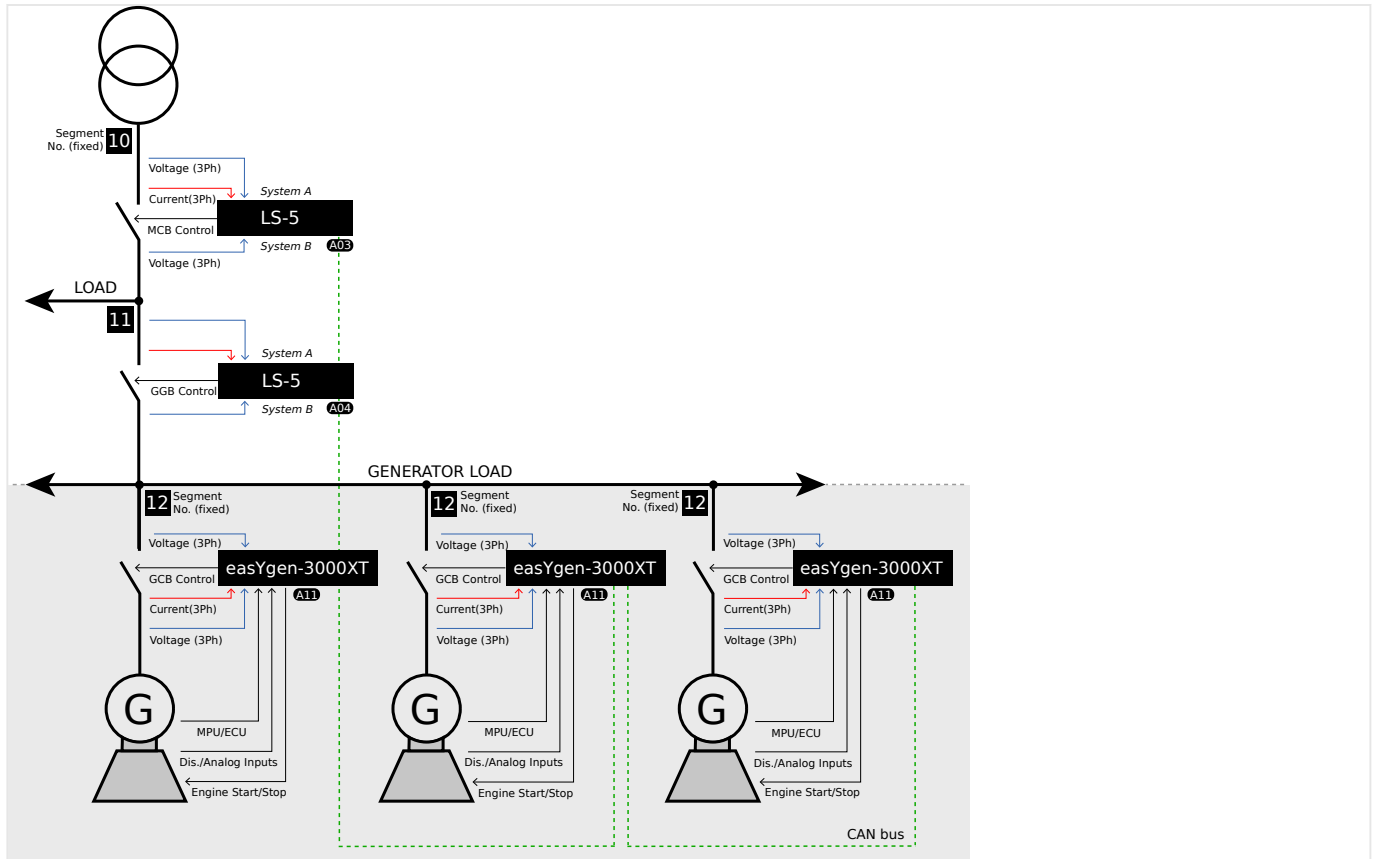

Fig. 258: Application mode A11 (schematic)



The easYgen requires the feedback reply of the GCB in this application mode. The GGB and MCB feedback replies are connected at the particular LS-5. The both LS-5 inform the easYgen so, that the unit can control frequency, share load with other gensets or perform active load control.

The following feedback signals and commands are used in this application mode and fixed to the respective discrete inputs and outputs:

- DI 8 "Reply GCB" (normally closed (break) contact)
- DO 6 "Command: GCB close"
- DO 7 "Command: GCB open" (optionally)



If a mains decoupling shall be executed via GCB, the mains measurement must be wired to the easYgen.



Refer to the LS-5 / LS-6XT manuals for details on the easYgen/LS-5 system configuration.

Engine operation in AUTOMATIC (basic function)

Engine starts, if

- The LogicsManager 86.09 LM: Start req.in AUTO is fulfilled (TRUE) AND
- A shut down alarm is not present AND
- The engine is ready for operation

With successful start the GCB closure is executed.

- If the voltage of generator and generator busbar is in range, the GCB will be synchronized
- If the voltage of generator is in range and the **generator busbar** is dead, no other GCB is closed and the GGB is open, the GCB will be closed

With configured generator power matched, the GGB and MCB will be operated according to the current active breaker transition mode.¹

Engine stops, if

- The LogicsManager 86.09 LM: Start req.in AUTO is not fulfilled (FALSE) OR
- A shut down alarm occurs

If all units stopped to the same time, the load will be transferred back to mains according to the current active breaker transition mode.

Being parallel to mains or to other generator, the own generator power will be reduced, before the GCB will be opened.

Depending on the GGB mode "ID3422", the GGB will be opened or kept closed.



Refer to [↪ "4.4.5.2 Operation Mode AUTO - Automatic Run"](#) for details.

Auto mains failure operation (AMF) in AUTOMATIC (basic function)

Engine starts, if

- The configured mains failure limits are reached AND²
- A shut down alarm is not present AND
- The engine is ready for operation

With successful start the GCB closure is executed.

- If the voltage of generator and generator busbar is in range, the GCB will be synchronized
- If the voltage of generator is in range and the **generator busbar** is dead, no other GCB is closed and the GGB is open, the GCB will be closed

With configured generator power matched, the GGB and MCB will be operated according to the current active breaker transition mode.

Engine stops, if

- The mains values are back in range AND²
- The mains settling time is expired³

The load will be transferred back to mains according to the current active breaker transition mode.

Depending on the GGB mode "ID3422", the GGB will be opened or kept closed.



¹ The GGB and MCB are operated by particular LS-5. Both LS-5 must be free of any alarm class C and E.

² The mains failure limits are configured in the LS-5 (operating range system A).

³ The mains settling time runs in the LS-5 at the interchange point. The easYgen indicates a running mains settling time.

6.1.12 Application mode A12 (GCB/L-GGBMCB)

This application mode (**A12**) may be used to operate the breakers GCB, GGB and MCB like in mode GCB/GGB/MCB (**A06**). But instead operating the GGB and MCB directly over relays the unit commands a single LS-5x2 or LS-6XT (two breaker LS-5, series II) to operate the GGB and MCB. The LS-5x2 or LS-6XT acts as slave for the easYgen in this mode.

These are dedicated modes for the easYgen-3500XT and the LS-5x2. The LS-5x2 or LS-6XT is to configure on:

- "CBA/CBB"
- AND
- "L-GGBMCB" mode.

No other LS-5 is allowed to be installed in this application mode. The bus segmenting is fixed through the application mode. If other breakers are available (other GGBs, MCBs, or tie-breakers) refer to GCB/LSx mode.

In comparison to the GCB/GGB/MCB mode:

- The customer can save wiring effort
- The export/import control can be provided with a 3-phase power measurement

Like in the GCB/GGB/MCB mode the GGB is closed, if a configured generator power is available on the busbar. Depending on the GGB mode "ID3422", the GGB will be opened or kept closed. The breaker transition modes "Open Transition", "Closed Transition", "Interchange" and "Parallel" are possible. The mains protection (mains decoupling) is maintained by the LS-5x2. If a mains decoupling according to VDE-AR-N 4105 is required refer to chapter [↳ "4.5.3.4.1 Setup Grid Code AR--4105"](#) for more insight.

The emergency mode (AMF operation) is also supported in this application mode. The LS-5x2 provides the easYgen-XT with active power and reactive power measurement. The online diagram of the easygen-XT shows the condition of the engine, the own GCB, the GGB, and the MCB.

As long as no mains decoupling for the GCB is required, the mains measurement of the easYgen-XT must not be wired. The feedback of the GGB and the MCB are detected by the LS-5 and the information is transferred to the easYgen-XT.

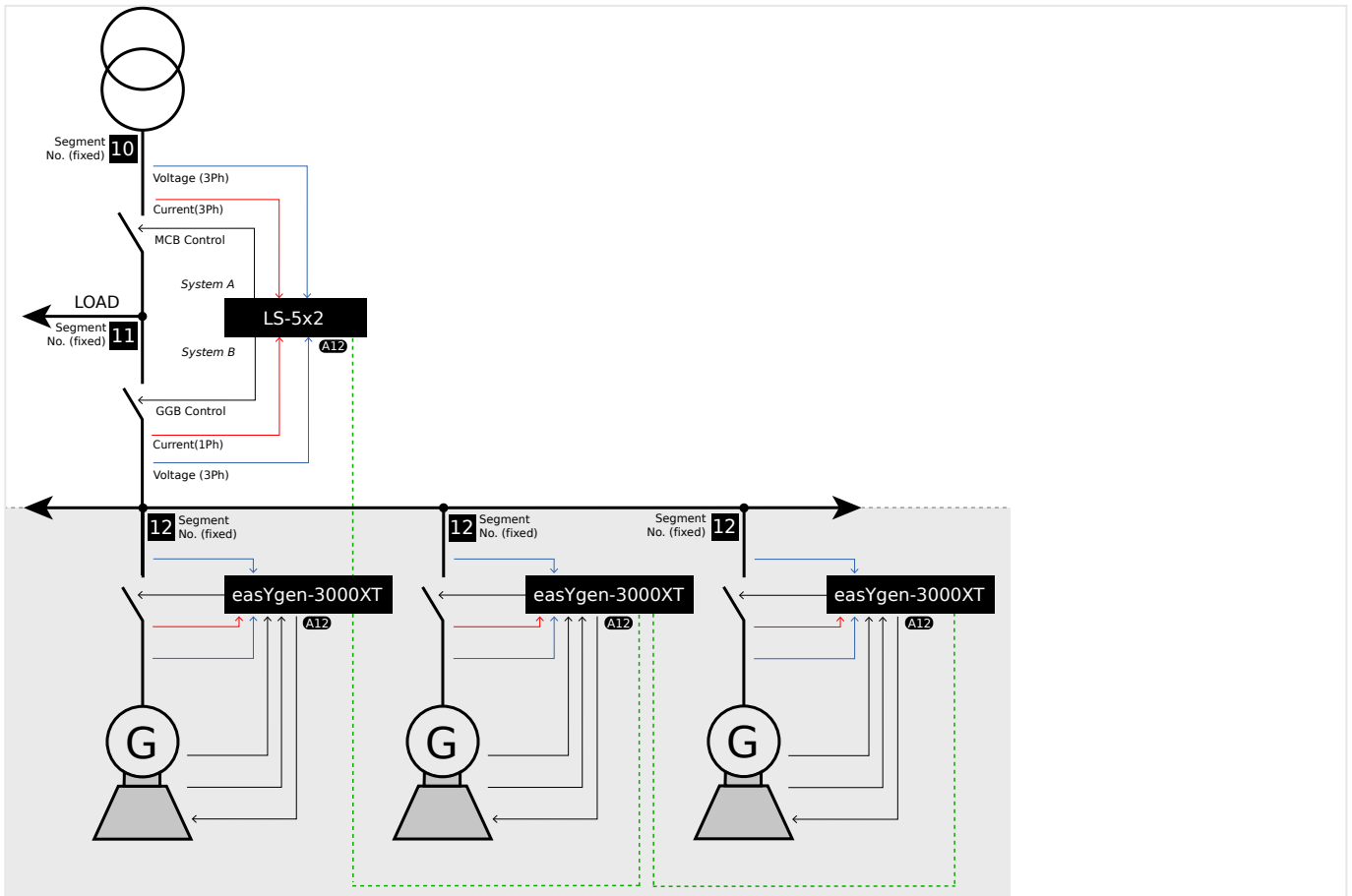

Fig. 259: Application mode A12 (schematic)



The easYgen requires the feedback reply of the GCB in this application mode. The GGB and MCB feedback replies are connected at the LS-5x2. The LS-5 informs the easYgen so, that the unit can control frequency, share load with other gensets or perform active load control.

The following feedback signals and commands are used in this application mode and fixed to the respective discrete inputs and outputs:

- DI 8 "Reply GCB" (normally closed (break) contact)
- DO 6 "Command: GCB close"
- DO 7 "Command: GCB open" (optionally)



If a mains decoupling shall be executed via GCB, the mains measurement must be wired to the easYgen.



Refer to the LS-5 II-series / LS-6XT manuals for details on the easYgen/LS-5 system configuration.

Engine operation in AUTOMATIC (basic function)

Engine starts, if

- The LogicsManager 86.09 LM: Start req.in AUTO is fulfilled (TRUE)
- AND
- A shut down alarm is not present
- AND
- The engine is ready for operation

With successful start the GCB closure is executed.

- If the voltage of generator and generator busbar is in range, the GCB will be synchronized
- If the voltage of generator is in range and the **generator busbar** is dead, no other GCB is closed and the GGB is open, the GCB will be closed

With configured generator power matched, the GGB and MCB will be operated according to the current active breaker transition mode.¹

Engine stops, if

- The LogicsManager 86.09 LM: Start req.in AUTO is not fulfilled (FALSE) OR
- A shut down alarm occurs

If all units stopped to the same time, the load will be transferred back to mains according to the current active breaker transition mode.

Being parallel to mains or to other generator, the own generator power will be reduced, before the GCB will be opened.

Depending on the GGB mode "ID3422", the GGB will be opened or kept closed.



Refer to [↳ "4.4.5.2 Operation Mode AUTO - Automatic Run"](#) for details.

Auto mains failure operation (AMF) in AUTOMATIC (basic function)

Engine starts, if

- The configured mains failure limits are reached
- AND²
- A shut down alarm is not present
- AND

- The engine is ready for operation

With successful start the GCB closure is executed.

- If the voltage of generator and generator busbar is in range, the GCB will be synchronized
- If the voltage of generator is in range and the **generator busbar** is dead, no other GCB is closed and the GGB is open, the GCB will be closed

With configured generator power matched, the GGB and MCB will be operated according to the current active breaker transition mode.

Engine stops, if

- The mains values are back in range

AND²

- The mains settling time is expired³

The load will be transferred back to mains according to the current active breaker transition mode.

Depending on the GGB mode "ID3422", the GGB will be opened or kept closed.



¹ The GGB and MCB are operated by particular LS-5. Both LS-5 must be free of any alarm class C and E.

² The mains failure limits are configured in the LS-5 (operating range system A).

³ The mains settling time runs in the LS-5 at the interchange point. The easYgen indicates a running mains settling time.

6.1.13 Application mode A13 (GCB/GC)

6.1.13.1 Introduction

This application mode (**A13**) is mainly intended for applications with more than 32 easYgens. Whereby one Group Controller (GC) bundles up to 31 easYgens. The GC handles this group as a big generator to the load bus bar and shares load across all groups. Maximum 16 GC can be supported. So that up to 496 generators can be installed. In this application mode applications with GC and LS-6XT are possible too.

Be aware that the Load Dependent Start Stop (LDSS) algorithm is in the GC and most LDSS-parameters must be configured in the GC.

According to the application example shown in ( Fig. 260) the application is grouped into **3 layers**.

- Layer 1 with the generators, easYgens, GCBs and eventually with LSx
- Layer 2 with the Group Controllers
- Layer 3 with the load bus bar and eventually with LS-6XT

The communication (Load share interface, **Layer 1**) between the GC and its easYgens can be configured as CAN, Ethernet A or redundant CAN/Ethernet A. The Group Controller appears in the diagnostic screen for the easYgen as 'GC (32)' and for the LSx as 'GC (33)'.

The communication (Load share interface, **Layer 3**) between the GCs and LS-6XT can be configured as Ethernet B, Ethernet C or redundant Ethernet B/C .

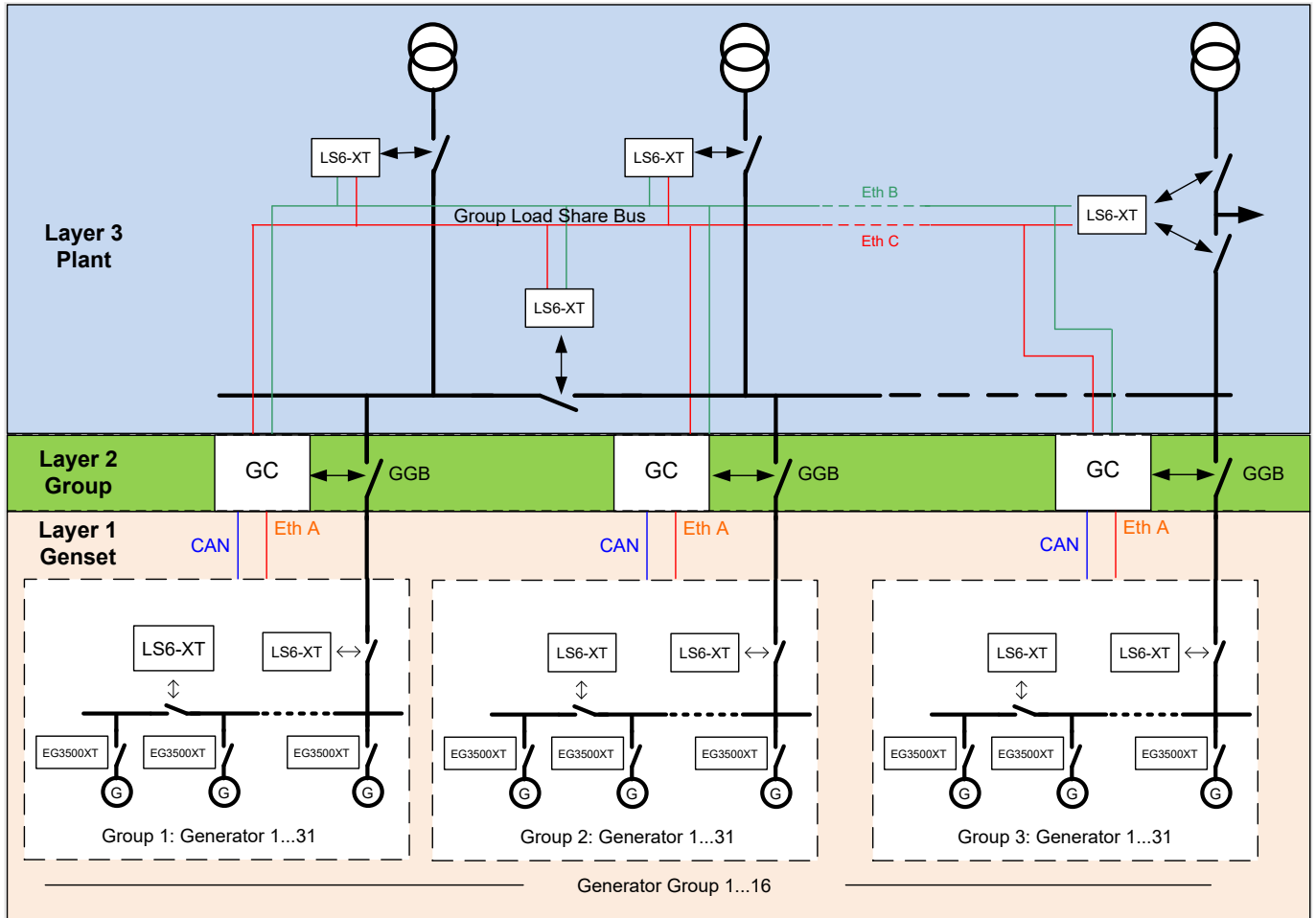

Fig. 260: Example application mode A13 with GC and LS-6XT



In the GC there is a parameter 'Application mode' too. This parameter determines whether Layer 3 contains LS-6XT (Mode = GGB/LSx) or not (Mode = GGB/MCB). In this manual only the application with GC-application mode GGB/MCB will be described. For detailed description refer to the GC manual.

6.1.13.2 Application mode A13 (GCB/GC) with GC-application mode GGB/MCB

This application mode is mainly intended for applications, with more than 32 generators. In the example the GC handles the GGB and the MCB and handles Load Dependent Start Stop (LDSS). The easYgen will function as an engine control with generator and engine protection.

The easYgen can open and close the GCB. The GCs can operate the GGBs and MCBs in the system. The application can be an isolated operation or a parallel to mains operation. During synchronization of the GGB or MCB the GC passes the set points to the easYgens of the groups. The group controller leads its own easYgens in active and reactive power to unloading the MCB at the interchange point.

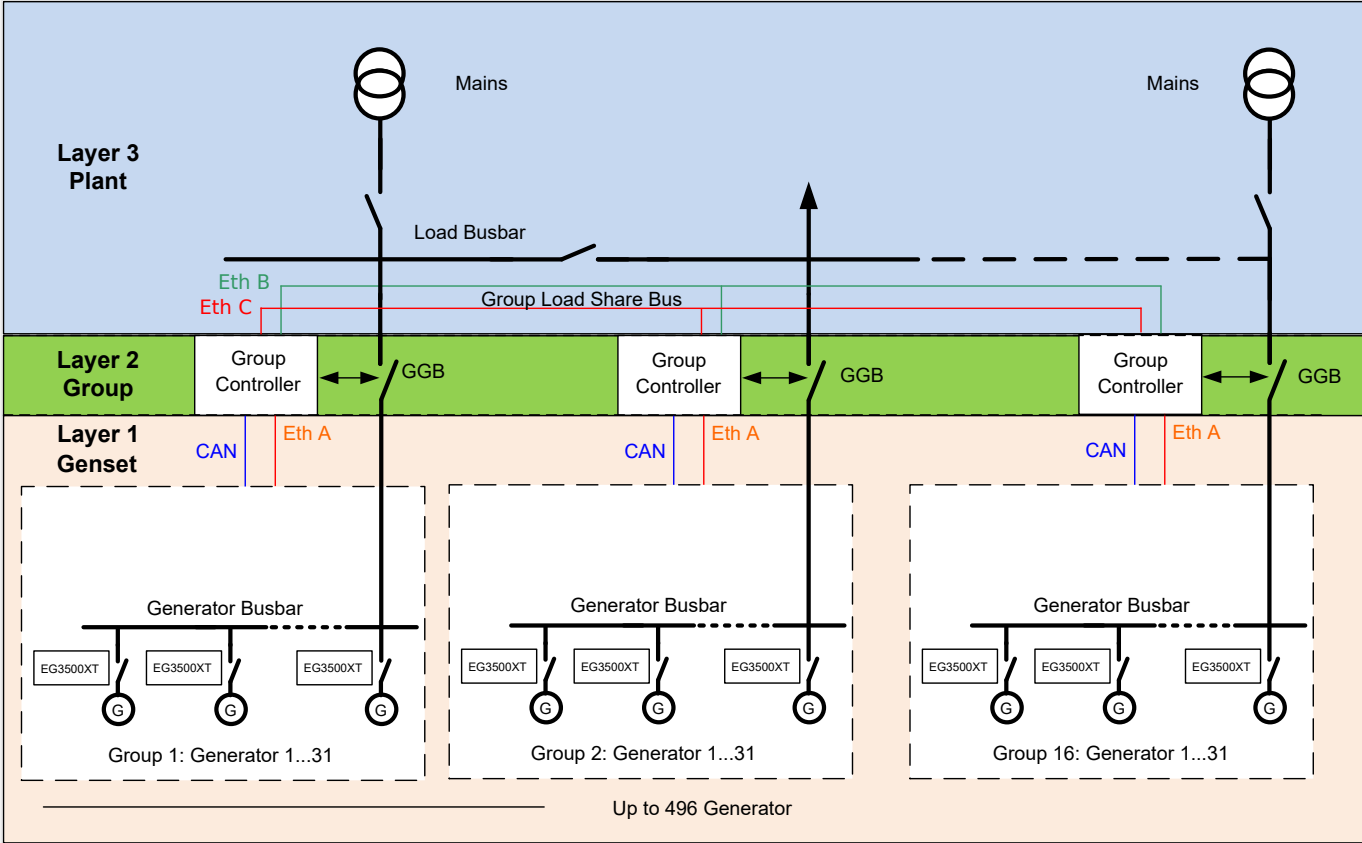

Fig. 261: Example application mode A13 with GC-application mode GGB/MCB

i Please note the mains power measurement which is fed to a GC will only be passed to the easYgens of its own group. A GC does not share mains power measurement between other GCs.

i The easYgen requires only the feedback reply from the GCB in this application mode. The other breaker replies are connected at the GC. The GC informs the easYgen so, that the easYgen can control frequency, share load with other gensets or perform active load control.

The following feedback signals and commands are used in this application mode and fixed to the respective discrete inputs and outputs:

- DI 8 "Reply GCB" (normally closed (break) contact)
- DO 6 "Command: GCB close"
- DO 7 "Command: GCB open" (optionally)

i If a mains decoupling shall be executed via GCB, the mains measurement must be wired to the easYgen.



Refer to GC Manual for details on the easYgen/GC system configuration.

Engine operation in AUTOMATIC (basic function)

Engine starts, if

- The LogicsManager 86.09 LM: Start req.in AUTO is fulfilled (TRUE) AND
- A shut down alarm is not present AND
- The engine is ready for operation

With successful start the GCB closure is executed.

- If the voltage of generator and generator bus bar is in range, the GCB will be synchronized
- If the voltage of generator is in range and the generator bus bar is dead and no other GCB is closed, the GCB will be closed

Engine stops, if

- The LogicsManager 86.09 LM: Start req.in AUTO is not fulfilled (FALSE) OR
- A shut down alarm occurs

Being parallel to mains or to other generators, the generator power will be reduced, before the GCB will be opened.



Refer to [↳ “4.4.5.2 Operation Mode AUTO - Automatic Run”](#) for details.

6.2 Multiple Genset Applications

Overview

In a multiple-unit mains parallel application, all easYgens need the same signals for:

- Mains voltage and current
- Reply and release signal of the MCB



The open and close contacts from all controls must be wired in parallel.

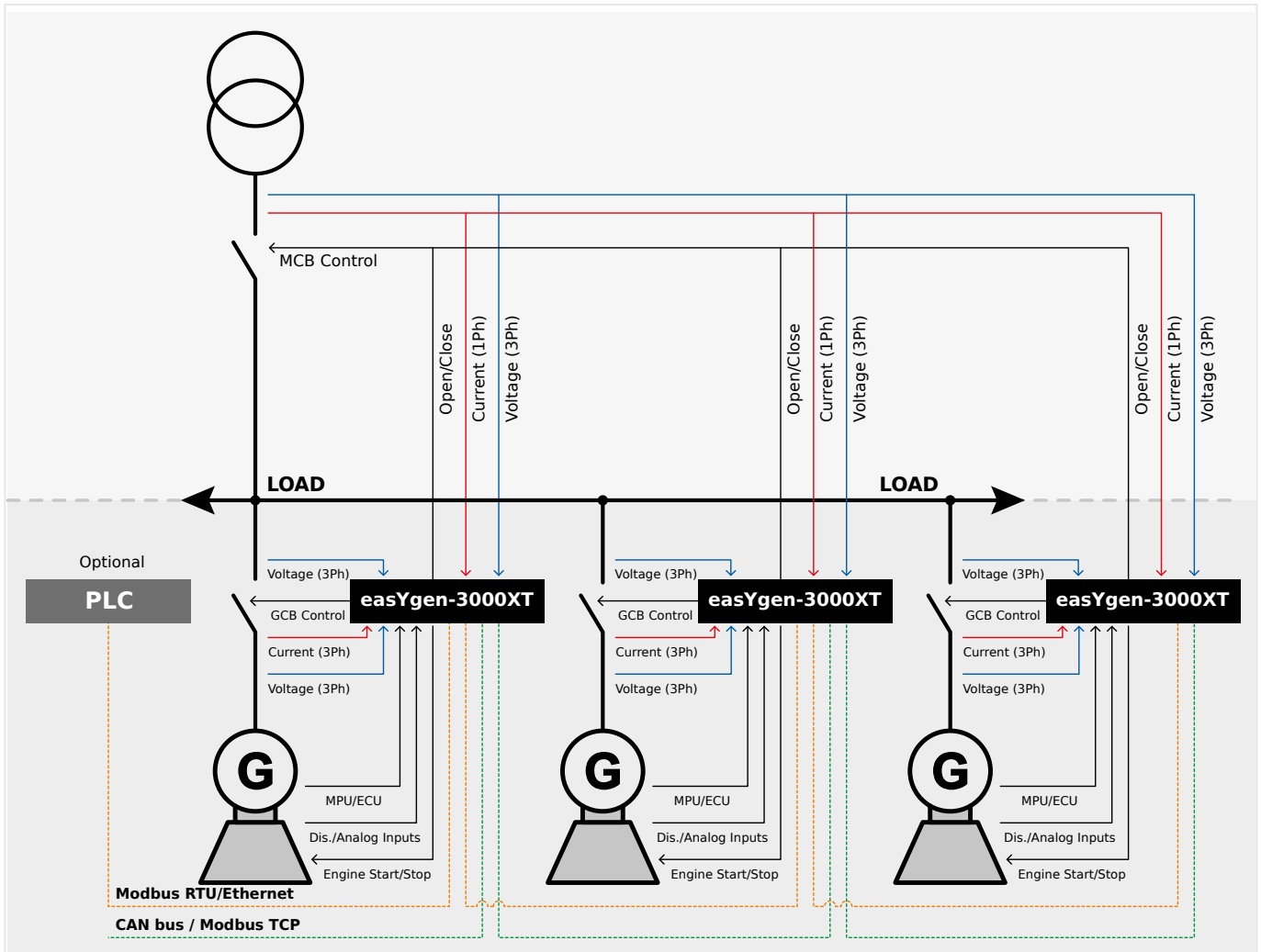

Fig. 262: Multiple genset application (schematic)

6.2.1 Configuration Example: Multiple Genset

Configuration example

The following example describes the configuration of a typical mains parallel operation with import/export power control at the interchange point and load-dependent start/stop.

Multiple generators are to be operated in parallel to the mains maintaining a stable power at the interchange point. The generators shall be started depending on the momentary load at the plant. An emergency operation in case of a mains failure is also intended.

The load dependent start/stop function (LDSS) shall be enabled with a remote start request. LDSS shall depend on the reserve power on the busbar. In case of a dead busbar (caused by a mains failure) all capable generators shall be started and operated with their minimum running time.

No generator priority is considered. Generator selection shall be performed depending on the operating hours.

The following assumptions are valid for the example:

- 3 generators, each with 80 kW rated power, are available.

- The recommended minimum load for the generators is 40 kW.
- The minimum running time is 180 s.

6.2.1.1 Configuring Load-Dependent Start/Stop

⚙️

1. ▷

i

In the Application mode "(GCB/GC" **A13** the LDSS algorithm is in the Group Controller. For this reason the functionality is different and in the easYgen only the following LDSS parameters are visible and valid in this mode: (Other configuration must be done in the Group Controller. Refer to GC manual)

- LD start stop (parameter [↪ 12930](#))
- Base priority (parameter [↪ 5751](#))
- Minimum running time (parameter [↪ 5759](#))
- LDSS transition time (parameter [↪ 5805](#))
- LDSS Priority 2 (parameter [↪ 12926](#))
- LDSS Priority 3 (parameter [↪ 12925](#))
- LDSS Priority 4 (parameter [↪ 12924](#))

Either on the front panel or using ToolKit navigate to menu [PARAMETER / Configuration / Configure application / Configure operation modes / Load dependent start/stop / General LDSS settings].

2. ▷ Configure the parameters below.

ID	Parameter	Value	Comment
5752	Start stop mode	Reserve power	The reserve power at the interchange point is to be considered for LDSS
5753	Dead busbar start mode	All	All generators shall start in case of a dead busbar (mains failure)
5751	Base priority	5	The base priority for the genset is 5
5754	Fit size of engine	No	The generator rated power is not considered for LDSS
5755	Fit service hours	Equal	The remaining hours until next service are considered for LDSS
5756	Changes of engines	Off	No engine change will be performed
5777	LDSS sort priority always	Off	LDSS priority follows settings without permanently refreshing.
5759	Minimum running time	180 s	The minimum running time is 180 seconds

ID	Parameter	Value	Comment
5805	LDSS transition time	60 s	LDSS transition time is 60s (only valid in GCB/GC mode A13)
12930	LD start stop	LM 86.86: TRUE	Enables function LDSS

3. ▷

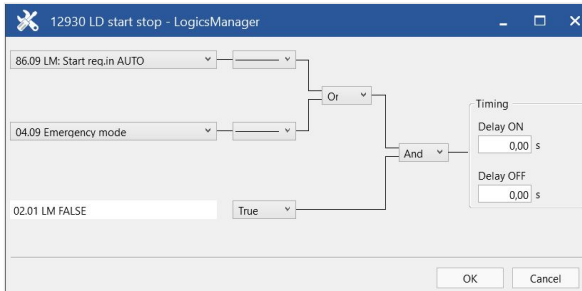

Fig. 263: LogicsManager function "LD start stop"

Configure the LogicsManager 86.86 function »12930 LD start stop« as shown in ([↩](#) [➤](#) "6.2 Multiple Genset Applications") to enable LDSS if a start request in automatic operating mode or emergency mode are enabled.

LDSS parameters for mains parallel operation

Additional assumptions are valid for mains parallel operation (MOP):

- The first generator is only started if it is able to operate at a minimum load of 40 kW.
- A hysteresis of 20 kW is required to avoid frequent starts and stops.
- A reserve power of 10 kW on the busbar shall be maintained, i.e. at least 10 kW of generator capacity are available for short load peaks.
Higher load peaks are supported by the mains.
- The delay for adding another generator shall be 30 seconds.
- The delay for adding another generator shall be reduced to 10 seconds if a generator at the busbar is operating above its rated load (accelerated start of the next generator).
- The delay for removing a generator from the busbar shall be 60 seconds.



1. ▷

Either on the front panel or using ToolKit navigate to menu [Load dependent start/stop / Mains parallel operation].

2. ▷

Configure the parameters listed below.

ID	Parameter	Value	Comment
5767	MOP Minimum load	40 kW	The minimum load in mains parallel operation is 40 kW

ID	Parameter	Value	Comment
5769	MOP Hysteresis	20 kW	The reserve power hysteresis in mains parallel operation is 20 kW
5768	MOP Reserve power	10 kW	The reserve power in mains parallel operation is 10 kW
5772	MOP Add on delay	30 s	The add on delay in mains parallel operation is 20 seconds
5773	MOP Add on delay at rated load	10 s	The add on delay at rated load in mains parallel operation is 10 seconds
5774	MOP Add off delay	60 s	The add off delay in mains parallel operation is 60 seconds

Table 106: Parameter configuration for LDSS (MOP)

LDSS parameters for islanded operation

Additional assumptions are valid for islanded operation (IOP), i.e. in case of an mains failure (emergency) operation:

- A reserve power of 80 kW on the busbar shall be maintained, i.e. at least 2 generators are available in islanded operation for redundancy because no supporting mains are present.
- A hysteresis of 20 kW is required to avoid frequent starts and stops.
- The delay for adding another generator shall be 10 seconds.
- The delay for adding another generator shall be reduced to 3 seconds if a generator at the busbar is operating above its rated load (accelerated start of the next generator).
- The delay for removing a generator from the busbar shall be 180 seconds.



1. ▷ Either on the front panel or using ToolKit navigate to menu [PARAMETER / Configuration / Configure application / Configure operation modes / Load dependent start/stop / Islanded operation].

2. ▷ Configure the parameters listed below.

ID	Parameter	Value	Comment
5760	IOP Reserve power	80 kW	The reserve power in islanded operation is 80 kW
5761	IOP Hysteresis	20 kW	The reserve power hysteresis in islanded operation is 20 kW
5764	IOP Add on delay	10 s	The add on delay in islanded operation is 10 seconds
5765	IOP Add on delay at rated load	3 s	The add on delay at rated load in islanded operation is 3 seconds

ID	Parameter	Value	Comment
5766	IOP Add off delay	180 s	The add off delay in islanded operation is 180 seconds

Table 107: Parameter configuration for LDSS (IOP)

6.2.1.2 Configuring Automatic Operation



1. ▷ Either on the front panel or using ToolKit navigate to menu [PARAMETER / Configuration / Configure application / Configure operation modes / Operation mode AUTO].

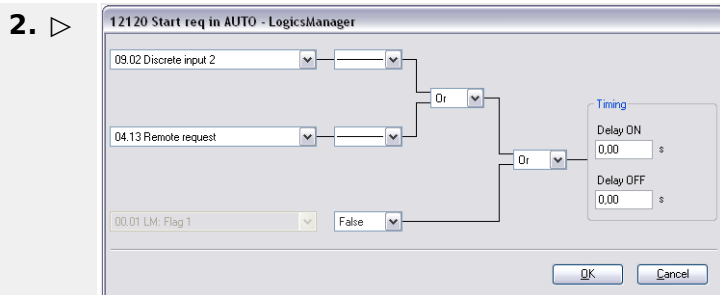

Fig. 264: LogicsManager function "Start req. in AUTO"

Configure the LogicsManager 86.90 function »12120 Start req. in AUTO« as shown in (Fig. 264) to start the generator in Automatic operating mode if discrete input [DI 02] ("09.02 Discrete input 2") is energized or a remote start request ("04.13 Remote request" = start via interface) is issued.

6.2.1.3 Configuring Emergency Operation

Configure emergency operation to be initiated if the mains fails for at least 3 seconds or the MCB cannot be closed.



1. ▷ Configure the parameters listed below.

ID	Parameter	Value	Comment
2802	Emergency run	On	Emergency operation is enabled
2800	Mains fail delay time	3.00 s	Emergency operation is initiated if the mains fail for a t least 3 seconds
3408	Emerg. start with MCB failure	Yes	Emergency operation is initiated if the MCB fails to close

Table 108: Parameter configuration for emergency run



See [↪](#) “4.4.6 Emergency Run” for further settings possibilities.

6.2.1.4 Configuring Power Control

Configure the power controller to use the internal power setpoint 1, which must be set to 0 kW import power.



1. ▷ Either on the front panel or using ToolKit navigate to menu [Configure load control].

2. ▷ Configure the parameters listed below .

ID	Parameter	Value	Comment
5539	AM ActPower SP1 [kW]	Determined by AnalogManager 81.05: [A1 = 05.54 Internal P setp1 [kW]]	The internal power setpoint 1 is used as load setpoint 1
5526	Load setpoint 1	Import	The internal power setpoint 1 is a import power value
5520	Int. load control setpoint 1	0 kW	The internal power setpoint 1 is configured to 0 kW

Table 109: Parameter configuration for import/export power control

6.2.2 Communication Management

6.2.2.1 System Update

General notes

The Communication Management gives an overview of all devices on the load share bus in the system with regard to their different interfaces (Ethernet and CAN). See screen  Fig. 266).

Additionally it provides functions to monitor the communication members and the interface. The monitor not only detects missing members, it also monitors a defined and stored constellation with the current constellation for deviations. This function is called »System Update«.

For a better understanding some expressions needs to be explained.

System update expressions and their meaning:

- »System update« or »System update function«:

Is the overall procedure that, if triggered, saves after 30 seconds the actual constellation of members.

- »System update order«:

Triggers the System Update function.  "How to initiate a system update"

- **»System update delay timer«:**

A timer of 30 second that starts after the System Update order was triggered.

- **»System update active«:**

This flag is active while the System Update delay timer is running.

- **»System update monitoring«:**

After the System Update function was triggered and is finished, the saved constellation is monitored in regards of any change.

- **»System update alarm«:**

Occurs if an additional device is recognized that does not exist in the actual saved constellation. See Alarmlist for more details.

- **»Missing Member alarm«:**

Occurs if a device is not recognized but exists in the actual saved constellation. See Alarmlist for more details.

With the System Update order, a delay timer of 30 seconds is triggered and will be sent to all other members on the load share and control bus. During this time the System Update and missing member monitoring is disabled to not interrupt a well working plant by upcoming alarm messages and control reactions on them due to shutting down a device for maintenance. Short before the delay timer ends, the System Update function saves the actual constellation of recognized devices.

During the delay time the LogicsManager flag *04.65 System update active* is active.

NOTICE!



A change of the device ID or of parameter »9924 Load share Interface« will reset the saved constellation and a new System Update order needs to be triggered.

After the System Update function is finished, the saved constellation will be monitored. Any deviation to this constellation will be recognized and noticed by an alarm that describes the type of change.

A missing member alarm is shown if a device, of the saved constellation, is not recognized anymore. If an additional device is recognized, that does not exist in the saved constellation, a System Update alarm is shown, see [»System update expressions and their meaning:«](#)

Each Alarm is also available as flag for the LogicsManager system.

To configure the »System update« Monitoring see [»4.5.6.20 Multi-Unit System Update«](#):



By default the Missing Member alarm is incorporated into the frequency droop LogicsManager [»12904«](#).

The system update function incorporates as well the LSx members on the control bus. So with the system update order the amount and constellation of all devices (easYgen and LSx) on the load share and control bus will be saved.

If a redundant Ethernet bus for load sharing is chosen, the system update function considers also the correct constellations of both buses. Additionally it gives insight and alerts, if the redundancy is lost or a new member is not registered properly.



Diagnostic screens

The easYgen-XT provides several overview screens to check all members on the load share and control bus to help trouble shooting. These screens should be watched, before the system update order is executed. These screens can be in the HMI under [Next Page / Multi-unit / Diagnostic devices] and in ToolKit under [STATUS MENU / Multi-unit / Diagnostic devices] .

For more details see  [“6.2.2.2 Diagnostic Screens”](#).



Availability

The system update function is available for all choices of »9924 Load share Interface«:

- Communication over CAN 3 bus
- Communication over Ethernet network A
- Communication over redundant CAN 3 bus and Ethernet network A
- Communication over Ethernet network B
- Communication over redundant Ethernet network B and C

How to initiate a system update

The system update order can be initiated with the following options:

- By Softkey button »Syst. upd.« in the HMI. Navigate to [Next Page / Multi-unit / Diagnostic devices]
- By ToolKit switch  13356 »System update«. Navigate to [STATUS MENU / Multi-unit / Diagnostic easYgen]
- By LogicsManager 86.35 with parameter  7801 »System update«. Navigate to [Parameter / Configure monitoring / Multi-unit functions]

NOTICE!



Please ensure, if you are using the LogicsManager »7801 System update« or the parameter »13356 System update«, that the signal goes false after executing. Otherwise, all buttons relating to system update are locked.

The actual constellation of all members on the load share and control bus is displayed on the according diagnostic screens in HMI and ToolKit.

6.2.2.2 Diagnostic Screens

The diagnostic screens are helping the operator to recognize the current communication state of the load share and control bus. These screens should be reviewed before executing a system update order. It is highly recommended to review the diagnostic

screen of each device that is participating on the load share/control bus. The system update function will save exactly the states which are displayed in these screens.

In case of a missing member or system update alarm, these screens will also help the operator to detect the root cause and for general troubleshooting.

The status of each device in the system will be indicated by a status "LED" in conjunction with a status text.



In GCB/GC mode **A13** the Group Controller appears in the easYgen diagnostic screen as 'GC (32)' and in the LSx diagnostic screen as 'GC (33)'.

In this mode also an additional diagnostic screen »Diagnostic GC« will be available in the HMI and ToolKit. This screen will show the status of all existing Group Controllers in the Layer 3 system. It also provides a separated parameter 13349 »Syst. upd.« order for the Layer 3 system.

The information of other Group Controllers on Ethernet B/C bus can only be received by Group Controller themselves. The easYgens receive the information about other groups for visualization purpose from their own GC via load share bus as they are never connected to the Ethernet B/C bus on which the GCs communicate between each other.



Load Share Gateways (LSG) will be shown in the diagnostic screens as easYgen devices.

Availability

There are diagnostic screens for the following devices (depending on the application mode):

- easYgen, **A01** to **A13**
- Group Controller, **A13**
- LSx Layer 1, **A07** to **A13**

Diagnostic Screen Parameter

ID	Parameter	CL	Setting range [Default]	Description
7801	System update	2	Determined by LogicsManager 86.35 [(0 & 1) & 1] = 11974	To select logical input(s) to cause a system update.
13356	System update (HMI: Syst. upd.)	2	Yes	Network is checked for members and its states. Updated results become new status.
			[No]	Check and update is disabled.
9925	Monitored easYgen	-/-	Latest result of members count	Result of members count driven by system update parameter 13356.

ID	Parameter	CL	Setting range [Default]	Description
9951	Valid easYgen devices	-/-	Actual count of valid devices	Actual count of devices that has sent valid data.
9926	Monitored LSx	-/-	Latest result of members count	Result of members count driven by system update parameter 13356. Notes Only applies to the application modes A07 to A13 .
9952	Valid LSx devices	-/-	Actual count of valid devices	Actual count of devices that has sent valid data. Notes Only applies to the application modes A07 to A13 .

Table 110: Parameter: Diagnostic Screens



All Diagnostic Screen Parameters are accessible via communication interfaces. The system update command can be initiated through a free control flag.

Diagnostic screens in the HMI

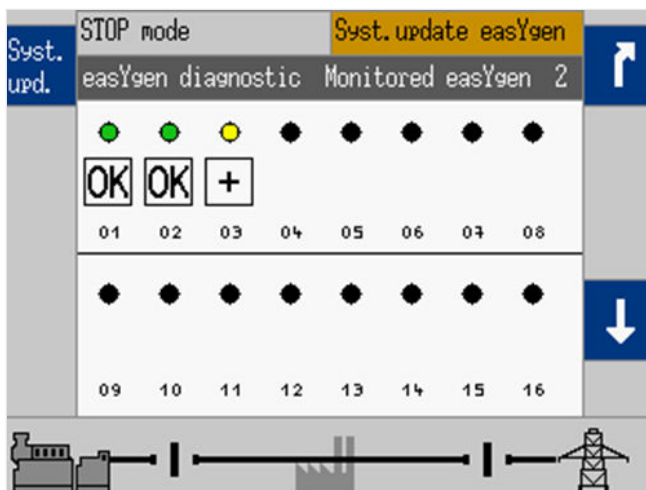

Fig. 265: Diagnostic screen example (HMI)

The HMI diagnostic screen shows, additional to the Status of each device, the number of Monitored devices and the »Syst. upd.« button to activate the System Update order, see [Table 110](#). While the System Update is active, the Event indication will show »System update«.

Because of space restrictions on the display, the status text of each device is realized with symbols. Use ToolKit for text indications.

Diagnostic screens in ToolKit

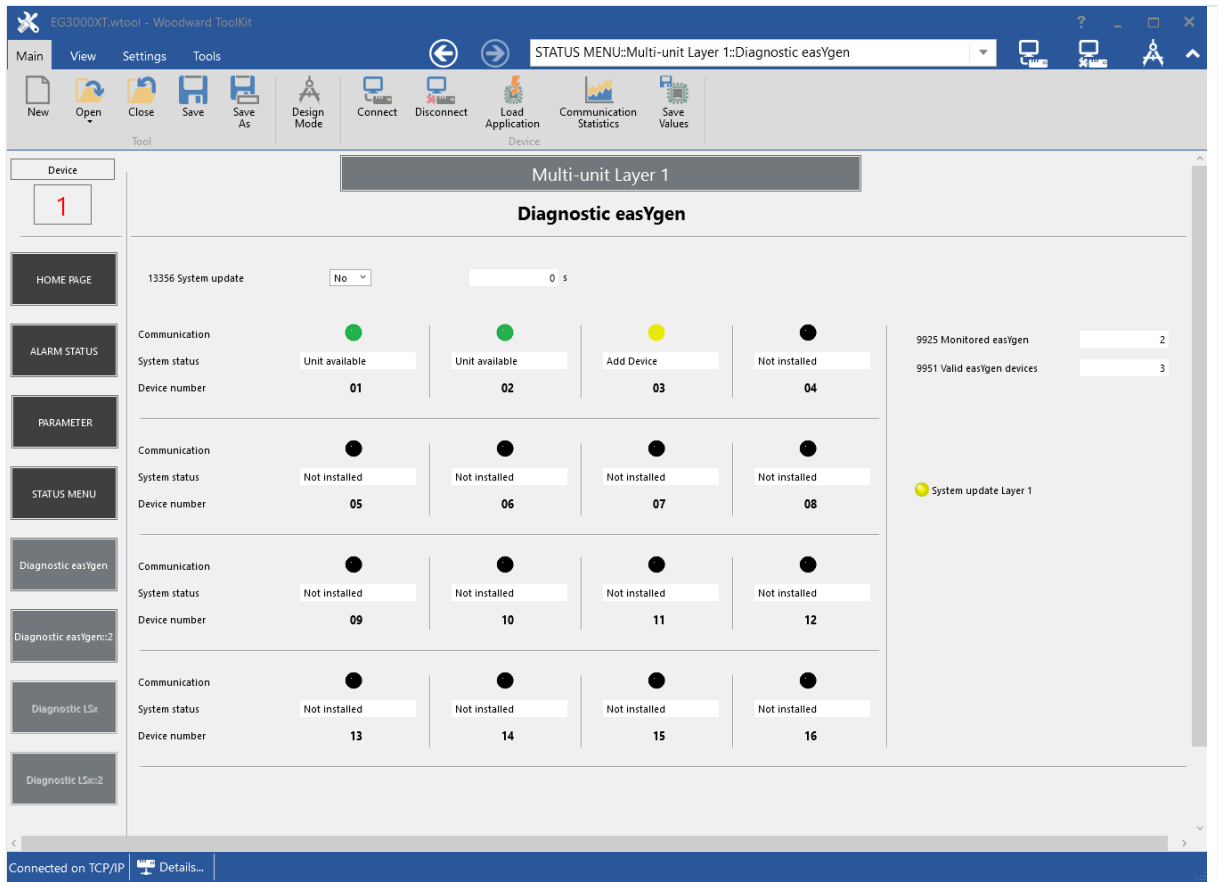

Fig. 266: Diagnostic screen example (ToolKit)

The ToolKit diagnostic screen shows, additional to the Status of each device, the number of »Monitored devices«, the number of »Valid devices« and the 13356 »System update« to activate the System Update order, see Table 110. While the System Update is active, the remaining time will be shown. An active System Update Alarm is also shown by the »Sys.update Layer1« LED.



It is possible, that several system status messages are active at same time. So the indication is prioritized:









- Unit not recognized (highest priority)
- Add Device
- Only NW CAN, Only NW A, Only NW B, or Only NW C
- Not installed

It is possible, that several system status are causing different LED messages. So the indication is prioritized:

- Red LED (highest priority)
- Yellow LED
- Black (off) LED







Diagnostic symbolic for single bus topology











Single bus topology means there is no redundant bus topology in use. Single bus topologies are load share over CAN bus or a single Ethernet network.









System and Control bus (CAN or single Ethernet)			
LED	ToolKit: displayed text	easYgen: HMI	Explanation
 GREEN	Unit available		This device is recognized and monitored with the missing member monitor according to the latest System Update order.
 YELLOW	Add Device		This device is recognized but not registered according to the latest system update order. Therefore, the missing member monitoring does not observe the device. System update is required!
 RED	Unit not recognized		This device is not recognized according to the latest system update order. (Missing Member Alarm)
 BLACK	Not installed		This device is neither recognized nor registered through the latest system update order.
 RED / BLACK (twinkling)	Unit not recognized / Not installed (twinkling)	 (twinkling)	This only applies to the own device. There is no other device recognized according to the latest system update. Therefore this unit is suspected to have an interface error as it does not see any device on the bus.









Diagnostic symbolic for redundant bus topologies

Redundant bus topology like CAN/Ethernet A to provide more safety in regards of load share communication.

System and Control bus (Redundant CAN/EthernetA)			
LED	ToolKit: displayed text	easYgen: HMI	Explanation
 GREEN	Unit available		This device is recognized and monitored with the missing member monitor according to the latest System Update order.
 YELLOW	Add Device		This device is recognized but not registered according to the latest system update order. Therefore, the missing member monitoring does not observe the device. System update is required!
 YELLOW	Only NW CAN		This device is not recognized on the Ethernet A bus according to the latest system update. Therefore, a Redundancy Lost Alarm is triggered.

System and Control bus (Redundant CAN/EthernetA)			
LED	ToolKit: displayed text	easYgen: HMI	Explanation
 YELLOW / BLACK (twinkling)	Only NW CAN / Not installed (twinkling)	 (twinkling)	This only applies to the own device. There is no other device recognized on the Ethernet A bus according to the latest system update. Therefore this unit is suspected to have an interface Ethernet A error as it does not see any device on Ethernet A. A Redundancy Lost Alarm is triggered.
 YELLOW	Only NW A		This device is not recognized on the CAN bus according to the latest system update. Therefore, a Redundancy Lost Alarm is triggered.
 YELLOW / BLACK (twinkling)	Only NW A / Not installed (twinkling)	 (twinkling)	This only applies to the own device. There is no other device recognized on the CAN bus according to the latest system update. Therefore this unit is suspected to have a CAN interface error as it does not see any device on the CAN. A Redundancy Lost Alarm is triggered.
 RED	Unit not recognized		This device is not recognized according to the latest system update order. (Missing Member Alarm)
 BLACK	Not installed		This device is neither recognized nor registered through the latest system update order.
 RED / BLACK (twinkling)	Unit not recognized / Not installed (twinkling)	 (twinkling)	This only applies to the own device. There is no other device recognized according to the latest system update. Therefore this unit is suspected to have an interface Ethernet A and CAN error as it does not see any device on the bus. A Redundancy Lost Alarm is triggered.

System and Control bus (Redundant EthernetB/C)			
LED	ToolKit: displayed text	easYgen: HMI	Explanation
 GREEN	Unit available		This device is recognized and monitored with the missing member monitor according to the latest System Update order.
 YELLOW	Add Device		This device is recognized but not registered according to the latest system update order. Therefore, the missing member monitoring does not observe the device. System update is required!
 YELLOW	Only NW B		This device is not recognized on the Ethernet C bus according to the latest system update. Therefore, a Redundancy Lost Alarm is triggered.
 (/)	Only NW B / Not installed		This only applies to the own device. There is no other device recognized on the Ethernet C bus according to the latest system update. Therefore this unit is suspected to have an

System and Control bus (Redundant EthernetB/C)			
LED	ToolKit: displayed text	easYgen: HMI	Explanation
YELLOW / BLACK (twinkling)	(twinkling)	(twinkling)	interface Ethernet C error as it does not see any device on Ethernet C. A Redundancy Lost Alarm is triggered.
 YELLOW	Only NW C		This device is not recognized on the Ethernet B bus according to the latest system update. Therefore, a Redundancy Lost Alarm is triggered.
 YELLOW / BLACK (twinkling)	Only NW C / Not installed (twinkling)	 (twinkling)	This only applies to the own device. There is no other device recognized on the Ethernet B bus according to the latest system update. Therefore this unit is suspected to have an interface Ethernet B error as it does not see any device on Ethernet B. A Redundancy Lost Alarm is triggered.
 RED	Unit not recognized		This device is not recognized according to the latest system update order. (Missing Member Alarm)
 BLACK	Not installed		This device is neither recognized nor registered through the latest system update order.
 RED / BLACK (twinkling)	Unit not recognized / Not installed (twinkling)	 (twinkling)	This only applies to the own device. There is no other device recognized according to the latest system update. Communication error on network. Therefore this unit is suspected to have an interface Ethernet B and Ethernet C error as it does not see any device on the buses.

6.2.2.3 Practicing the System Update Functionality



Commissioning

1. ▷ If the devices are connected to a network system, during the first commissioning it is to observe in the diagnostic screens, whether all devices are recognized. Additional to that the sum of all easYgen devices must match the number shown at parameter »9951 Valid easYgen devices«, see [↪ Table 110](#).



For application mode **A07** to **A13** the sum of all LSx devices must match the number shown at parameter »9952 Valid LSx devices«.

If all these conditions are fulfilled the system update order can be executed. If any condition is not fulfilled do trouble shooting before you hit any system update order.

NOTICE!



It is highly recommended to verify the diagnostic screen of each device in the system.

2. ▷ Executing system update order

- ▶ After 30 seconds all devices must be indicated with a green lamp in the diagnostic screens. The sum of all easYgens devices must match the number shown at parameter »9925 Monitored easYgen« and »9951 Valid easYgen devices«.



For application mode **A07** to **A13** the sum of all LSx devices must match the number shown at parameter »9926 Monitored LSx« and »9952 Valid LSx devices«.

 **Adding a device to an already running and commissioned network**

- 1. ▷** Connect the additional device onto the network.
- 2. ▷** Check the availability in the diagnostic screen. The new device is indicated by a yellow LED and with status text »Add device«.
- 3. ▷** Execute the system update order
- ▶ After 30 seconds all devices must be indicated with a green lamp in the diagnostic screens. The sum of all easYgens devices must match the number shown at parameter »9925 Monitored easYgen« and »9951 Valid easYgen devices«.

 **Removing a device from an already running and commissioned network**

- 1. ▷** Execute the system update order



If you are removing the device before you hit the system update order, it is important to know that it will come to a missing member alarm with the consequence that the system goes into a droop function (if configured). If that has happened, this issue can be solved by a system update order. But do not forget to make a system check via the diagnostic screens.

- 2. ▷** You have now 30 seconds time to remove the device, without getting any consequences on the system.

6.2.2.4 Tips for commissioning load share communication via Ethernet

Preliminary notes

In cases where the system information (e.g. load sharing) is routed via Ethernet, UDP messages are exchanged. This Ethernet network can become relatively complicated. The complexity is generated among other things by the number of subscribers, switches, remote panels and gateways. Depending on the application, the easYgen can reach a limit at which the acceptance and transmission of the data cannot be implemented

without exception with the configured transmission rate. This is usually not critical because the UDP messages are constantly sent and thus the latest information is immediately available again.

However, to ensure and verify stable communication, the easYgen offers various instruments listed below.

Instruments to monitor and adapt stable communication



Please note that changing one of these settings have to be changed in all members to the same value.

1. The System Update Diagnostic Screens (refer to [↗ “6.2.2.2 Diagnostic Screens”](#)). They indicate whether system data arrives at the easYgen at all.
2. Use the flags "08.78 easYgen LS timeout", "08.79 LSx LS timeout" and "08.80 Redundancy LS timeout": The easYgen can store the configured and overflowed timeouts as collective flag in the LogicsManager pool. It is also possible to display this collective flag temporarily in the event log during commissioning (see parameter "Load share timeout event" [↗ 2442](#)).
In this way, the frequency and duration of the timeout can be observed over a longer period of time. (Refer to [↗ “Load share timeouts”](#).)
As a rule, this timeout event should be switched off again, because it could possibly fill up the event logger unnecessarily. The entries may well come once but are not critical if they come only a few times a day. There are the classic alarms for missing member and loss of redundancy anyway.
3. Set "Timeout cycles"([↗ 7489](#)): It is not uncommon to experience delays in sending and receiving UDP messages. At inopportune moments, too many UDP and TCP/IP messages can accumulate at a device/switch or gateway, which are then processed successively. This means that, on average, the news gets through, but it could be delayed for a short time. This circumstance can be monitored with an adjustable limit value in order to be able to balancing out the critical case.
The default setting is 5 cycles. This means that this example results in a basic tolerance of 400ms at 80ms transmission rate before an easYgen or LSx timeout flag occurs.
4. Set "Timeout cycles data"([↗ 7497](#)): As already explained under point 3, so-called timeout flags can occur, which make a statement about how often data delays occur. As long as they are rare, they give a good picture of the nature of communication. However, if there is a long-pending timeout flag, this communication partner must be removed and its data deleted so that the system can continue to work correctly.
This adjustable limit is now offered to determine when the data deletion should be triggered after the timeout has been determined with the "Missing Member" alarm.
The default setting is 12 cycles. This means that the generator is extinguished and thus removed after 1.36 seconds at a transmission rate of 80ms. Refer to note below.
5. Set "Transmission rate"([↗ 7488](#)): This is offered as a multiple of 80ms. The default setting is 80ms. If easYgen and LSx timeout entries in conjunction with missing members come too often or the amount of devices expires 32 members in Ethernet B/C redundant mode the

transmission rate is to increase. Refer also to chapter [↪](#) “6.2.4 Ethernet Communication - General Measures to optimize bus load on easYgen devices” for more information.



Note: Please note that system information such as Start/Stop commands or setpoints can be deleted by a communication partner if this participant has been detected as a missing member.

Measures to monitor the communication

Base is the default setting:

"Transmission rate"([↪ 7488](#)): 80 ms

"Timeout cycles"([↪ 7489](#)): 5 -> (Timeout after 80ms x 5 =400ms)

"Timeout cycles data"([↪ 7497](#)): 12 -> (Timeout data after 80ms x 5 + 80ms x 12 = 1360ms)

1. If easYgen and/or LSx have timeouts but there are **no** missing member alarms, you should increase only the "Timeout cycles". For example:
7488 Transmission rate: 80 ms
7489 Timeout cycles: **12**
7497 Timeout cycles data: 5 -> (Timeout data after 80ms x 12 + 80ms x 5 = 1360ms)
2. If easYgen and/or LSx have timeouts **and** missing member alarms, you should increase "Transmission rate"([↪ 7488](#)) in steps of 80 ms. For example:
7488 Transmission rate: 160 ms
7489 Timeout cycles: 5
7497 Timeout cycles data: **4** -> (Timeout data after 160ms x 5 + 160ms x 4 = 1440ms)

6.2.3 Ethernet Interconnectivity

Introduction

The easYgen offers the possibility to send and receive data via the Ethernet communication bus. To configure the data transfer from easYgen to easYgen there is to download the latest Windows PC Program “InterConnectMapper” from Woodward.

The InterconnectMapper tool allows creating setup files for EG3000XT and related devices, which allows them to communicate to each other using UDP messages by cyclically transmitting data between them. For each device in a setting, it can be defined who sends which data at which rate and every device in a setting can subscribe to this data, store it and use it for their purposes.

Up to 99 analog values of the AnalogManager group 54 and up to 99 Boolean values of the LogicsManager group 54 can be used for receiving data from other devices. All analog values which are present in the device as AnalogManager values and all flags which are present as LogicsManager values can be sent. Some data defined as indices and constants are also send able. Boolean flags can be grouped into 16 bit values.

These definitions will be packed into map files which can be uploaded to the devices. The tool will create SCP files for these to upload the mappings via Woodward Toolkit. The tool also allows the user to upload the map files directly. This is maintained by ftp access to the devices.

Note: The tool is designed for Windows 10 or higher. The tool requires a license. When unlicensed it will be functional but will not create mapping files.

Examples of Data Transfers

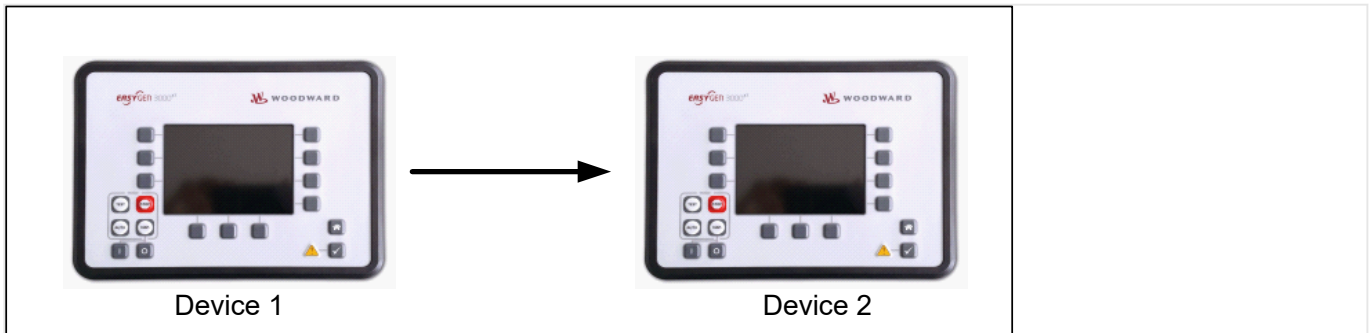

Fig. 267: Device 1 sends data to device 2

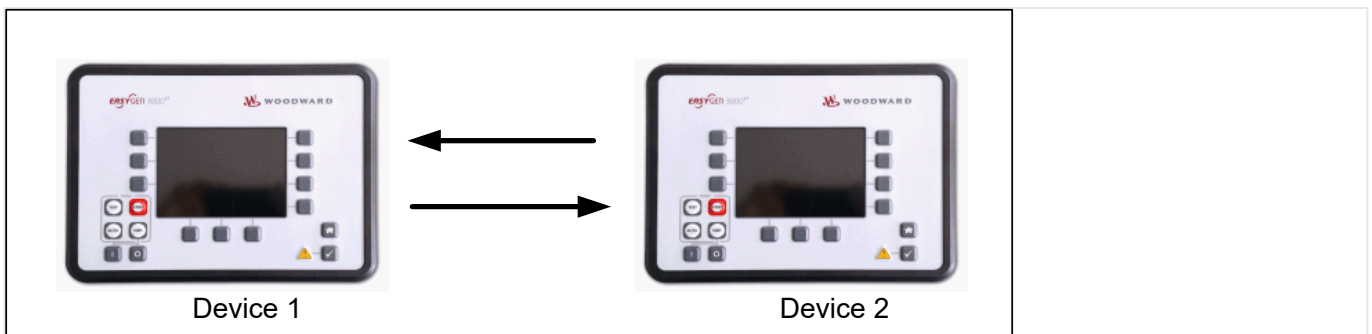

Fig. 268: Device 1 and Device 2 exchange their data

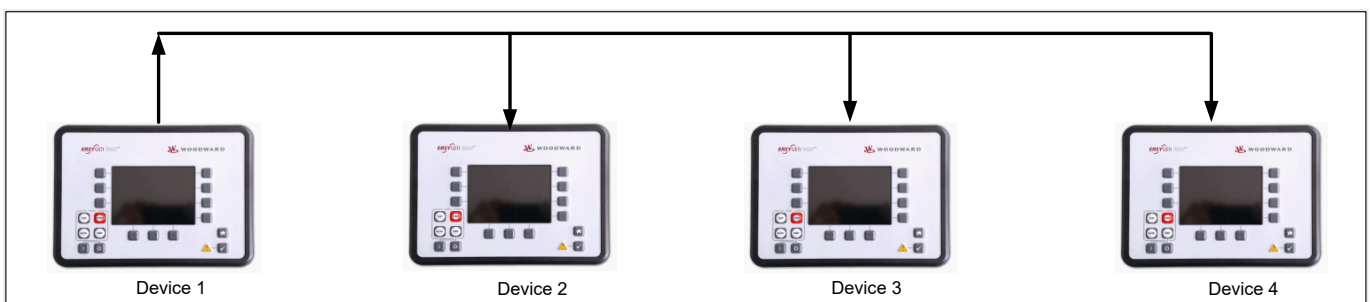

Fig. 269: Device 1 sends data to device 2, 3 and 4

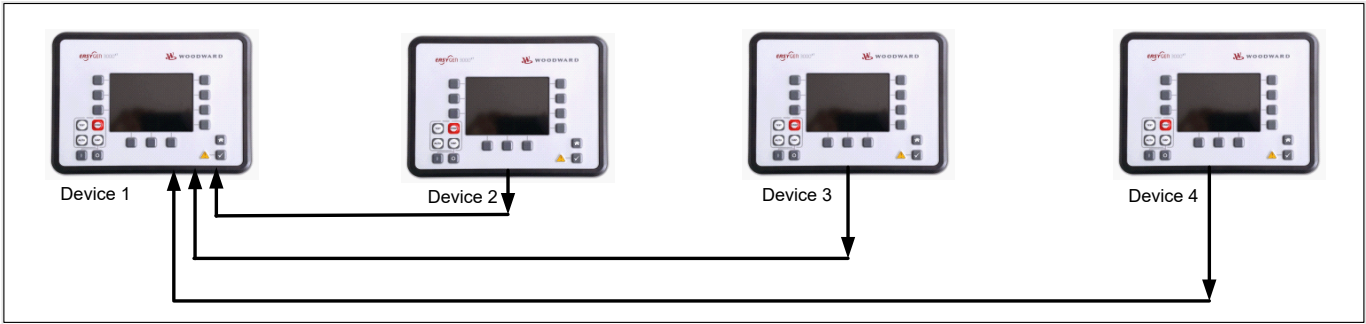

Fig. 270: Device 1 receives data from device 2, 3 and 4

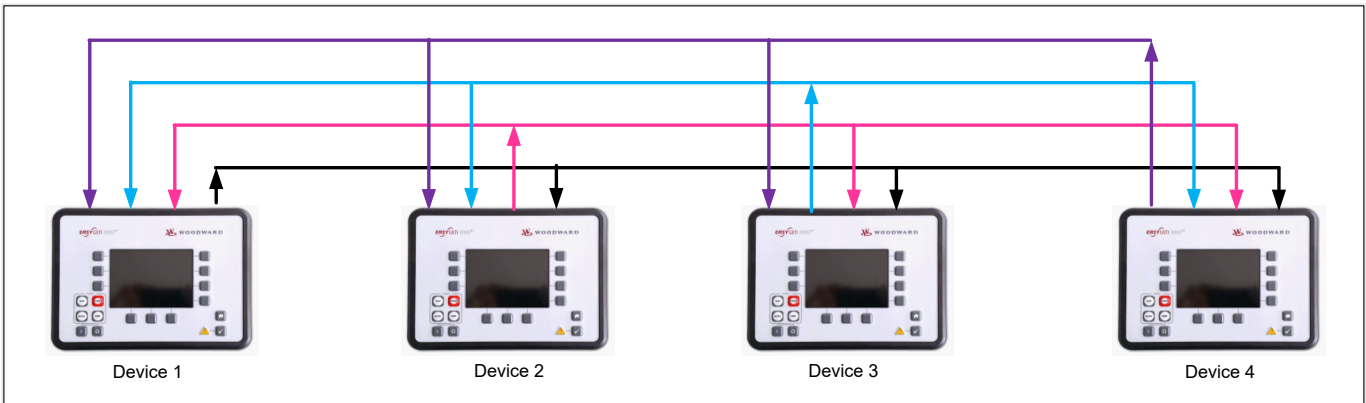

Fig. 271: Each Device receives data from the other devices

6.2.3.1 Configuration

Installation of InterconnectMapper software



Woodwards InterconnectMapper software is required. To obtain this software you can either go over link: \Rightarrow <http://www.woodward.com> where you navigate to Industrial / Technical Help Desk / Software LOOKUP / ...and typing Interconnect Mapper into the search window.

or

you can download it from internet \Rightarrow https://wss.woodward.com/manuals/PGC/easYgen-3000XT_series/SW_Tools

Prepare the InterconnectMapper software:

- Download the InterconnectMapper Tool from the Woodward support page.
- Install this PC program on your Windows PC running Windows 10 or higher.
- Start the PC program and study at first the "HELP file". (To find under the TAB "Help".)
- Check out the according license for the InterconnectMapper Tool.

If you have no experience with the InterconnectMapper Tool begin with a small project to send data from one device to the other. Keep the "HELP file" open to go forward step by step.

In the program you will be asked to specify a package zip software.



The InterconnectMapper will ask for allocating package zip software. Each easYgen type and revision has an own multilingual_package zip software. To obtain this software you can either go over \Rightarrow www.woodward.com where you navigate to Industrial / Technical Help Desk / Control Configuration Files

or

you can download it from internet \Rightarrow https://wss.woodward.com/manuals/PGC/easYgen-3000XT_series

- Navigate to your model
- Navigate to 02_Config_Files_
- Navigate to your part number and revision
- Download XXXX-XXXX_Y_multilingual_package
- Store it into your project folder

Status/diagnostic Interconnectivity

Toolkit is providing a screen for some Ethernet InterconnectMapper diagnostics. You find it under STATUS MENU/Interfaces/Ethernet/Interconnectivity.

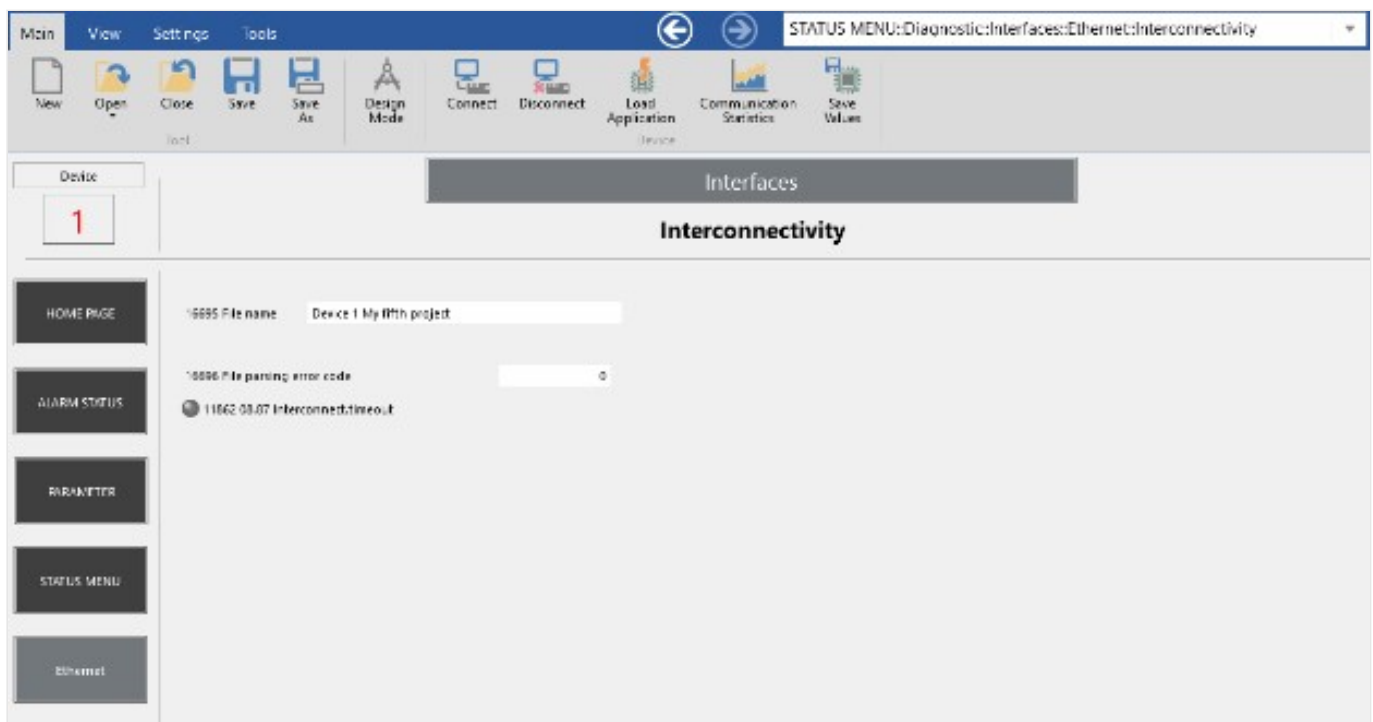

Fig. 272: Interconnectivity ToolKit status page

16695 File name:

This field shows the "Description". This is the comment in the map file, text defined by the PC tool.

16696 File parsing error code:

This is a numeric code indicating whether the map file was parsed correctly. The code is a combination of errors which have the following meaning:

16696 File parsing error code:	
Code	Meaning
0	No error (All values > 0 will result in interconnectivity not active)
1	File error: File was not found or could not be opened.
2	Not a mapping file: The file is not an interconnect mapping file or a malformed one.
4	Wrong version of mapping file: The version of the mapping file does not match. This can appear when the file was generated by an older version of the PC tool.
8	Mapping file has wrong checksum: The mapping file was corrupted and is invalid. It must be newly created.
16	APPLICATION line wrong in file. The file was created for an application which does not match to the application running on the device. This error is for future and is currently never produced.
32	RELEASE line wrong in file. The file was created for a software release which does not match to the application running on the device. This error is for future and is currently never produced.

LED 11862 08.87 Interconnect.timeout:

This is a flag for the receiving device to indicate if there is a timeout on the data it is to receive. Normally, this should be off.

6.2.4 Ethernet Communication - General Measures to optimize bus load on easYgen devices

6.2.4.1 General

The easYgen (and its platform derivatives) is a system device with increasing demand on its communication interfaces. So typical exercises are for example: Load sharing of up to 32 gensets, interacting with up to 32 LSx devices (only EG3500), Modbus TCP master and TCP slave activities, Ethernet interconnectivity function and RP3000XT connection. Furthermore the Ethernet communication bus of the easYgen platform can be performed redundant which doubles the amount of UDP messages and loads the easYgen additionally.

6.2.4.2 CPU System Load as Indicator

The easYgen provides a CPU load diagnostic on display (also accessible on Modbus). You can navigate to it with: Next Page/Diagnostic/Miscellaneous/ CPU Load diagnostic  "Special screen: "CPU Load diagnostic""

CPU Load diagnostic indication			
10296	System load	0 to 100 %	System Load

NOTICE!

The Ethernet communication influences the CPU system load. That's why it is important to keep an eye on the system load indication of the easYgen. The system load should not exceed 25% for longer than a few seconds.

6.2.4.3 What can be done to reduce Ethernet communication load

- Interconnectivity Function: Keep the number of UDP-messages low (messages from device to device)
- Interconnectivity Function: Increase the refresh rate of the UDP messages (refresh rates \geq 500ms, via InterconnectMapper tool)
- Interconnectivity Function: Perform it without the redundancy feature (without Ethernet B/C)
- Load share communication: Increase the "Transmission rate" \hookrightarrow 7488
- Load share communication: Set up the Ethernet redundancy externally.



There is a thumb rule: When you run load sharing in Ethernet B/C mode (redundant) and you exceed the amount of 32 devices (easYgen, LSx) in the according layer it is recommended to switch on a higher "Transmission rate" (i.e.160ms).

6.2.4.4 Ethernet Load - Application Examples

The following table is intended to show examples of what easYgen can do if the appropriate parameters are observed.

Application	Set up	7488 Transmission rate	Max. System load	Min. Idle load
Load sharing and control with 32 Devices on Ethernet B	<ul style="list-style-type: none"> • Remote Panel on Ethernet A • Interconnectivity with 31 messages. Transmission rate is 100ms. • "7489 Timeout cycles" = 5 • "7497 Timeout cycles data" = 12 	80 ms	20 %	37 %
Load sharing and control with 64 Devices on Ethernet B	<ul style="list-style-type: none"> • Remote Panel on Ethernet A • Interconnectivity with 63 messages. Transmission rate is 100ms. 	80 ms	23 %	32 %

Application	Set up	7488 Transmission rate	Max. System load	Min. Idle load
	<ul style="list-style-type: none"> • "7489 Timeout cycles" = 5 • "7497 Timeout cycles data" = 12 			
Load sharing and control with 32 Devices on Ethernet B /C (redundant)	<ul style="list-style-type: none"> • Remote Panel on Ethernet A • Interconnectivity with 31 messages. Transmission rate is 100ms. • "7489 Timeout cycles" = 5 • "7497 Timeout cycles data" = 12 	80 ms	23 %	32 %
Load sharing and control with 64 Devices on Ethernet B /C (redundant)	<ul style="list-style-type: none"> • Remote Panel on Ethernet A • Interconnectivity with 63 messages. Transmission rate is 200ms. • "7489 Timeout cycles" = 5 • "7497 Timeout cycles data" = 5 	160 ms	23 %	32 %

6.2.4.5 Recommendations for Software releases before 2.15

easYgen3000XT Software 2.12-1 and previous (without buffer): Maximal Number of Devices

Please take in mind that with easYgen3000XT software version 2.12-1 and older an appropriate Ethernet network buffer was missing. This buffer is now installed in software 2.12-4 and 2.15. That leads now to a better performance in the 2.12-4 as a possible hotfix software. Through a special UDP sending management in the software 2.15 the performance could be further improved. Refer to chapter “6.2.4 Ethernet Communication - General Measures to optimize bus load on easYgen devices” to see what the 2.15 can achieve. This table informs you what number of devices can be achieved for a proper Ethernet communication.

Ethernet Communication		
easYgen 3000XT	Maximal Number of Devices in Layer 1 or 3	7488 Transmission rate
easYgen 3000XT SW 2.12-1 and previous (without buffer)		
<ul style="list-style-type: none"> • Single Mode - Load sharing and control on Ethernet A or B • Remote Panel on Ethernet A 	13 devices	80 ms

Ethernet Communication		
easYgen 3000XT	Maximal Number of Devices in Layer 1 or 3	7488 Transmission rate
easYgen 3000XT SW 2.12-1 and previous (without buffer)		
<ul style="list-style-type: none"> "7489 Timeout cycles" = 10 		
<ul style="list-style-type: none"> Redundant Mode - Load sharing and control on Ethernet A or B Remote Panel on Ethernet A "7489 Timeout cycles" = 10 	7 devices	80 ms
easYgen 3000XT SW 2.12-4 (with buffer)	Maximal Number of Devices in Layer 1 or 3	7488 Transmission rate
<ul style="list-style-type: none"> Single Mode - Load sharing and control on Ethernet A or B Remote Panel on Ethernet A "7489 Timeout cycles" = 5 "7497 Timeout cycles data" = 12 	40 devices	80 ms
<ul style="list-style-type: none"> Redundant Mode - Load sharing and control on Ethernet A or B Remote Panel on Ethernet A "7489 Timeout cycles" = 5 "7497 Timeout cycles data" = 12 	20 devices	80 ms

NOTICE!



In applications where software versions are to be mixed, it is recommended to update SW to 2.15 or higher. In cases, where an update is not possible the limits in the above tables applies.

6.3 Special Applications

6.3.1 Generator Excitation Protection

The easYgen controller provides the user with power factor monitoring. These monitoring functions permit for protection of the generator over- and under-excitation. The power factor monitoring consists of a warning alarm and/or a shutdown alarm when enabled.

An alarm and the specified action will be initiated if the monitored power factor surpasses the defined limits. Typically the generator is monitored for loss of excitation and/or over excitation in a mains parallel application.

When a generator plant is paralleled against a utility, it is possible to control the power factor at a desired reference. When the plant is operated in an island mode or islanded parallel application, it is not possible to control the power factor. The load will dictate what the power factor is due to the reactive nature of the load.

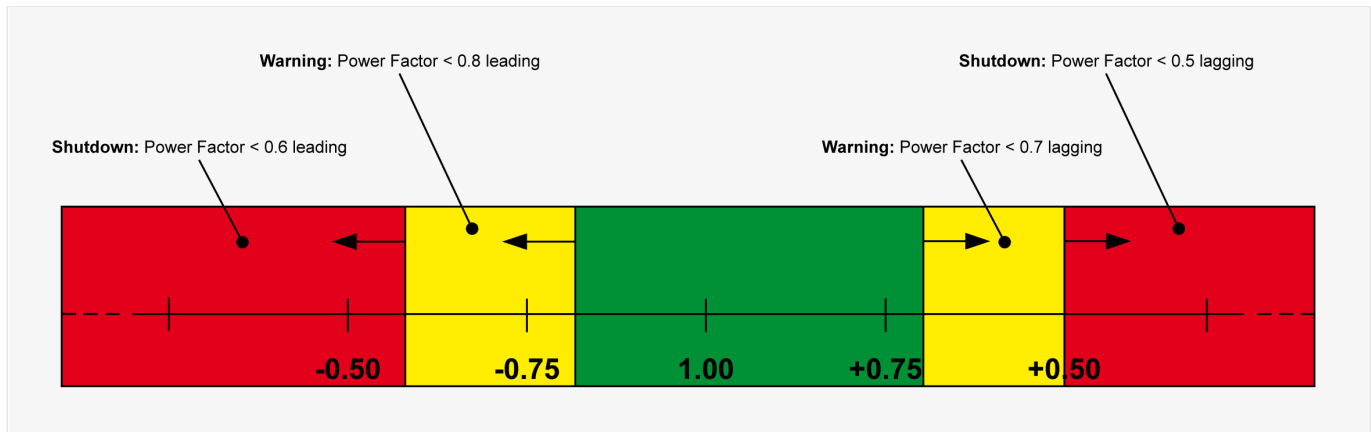

Fig. 273: Example - generator excitation protection

↳ Fig. 273 shows a typical power factor (generator excitation) protection range, where the desired range of operation (green area) is from 0.7 lagging (inductive) to 0.8 leading (capacitive).

When the power factor exceeds either of these limits by entering the yellow shaded areas starting at 0.7 lagging or 0.8 leading for more than 30 seconds, a class B warning alarm is initiated.

If the power factor exceeds the desired range further and enters the red shaded areas starting at 0.5 lagging or 0.6 leading for 1 second, a class E alarm is initiated and the generator is shut down.

Configuration

⚙️

1. ▷

In order to achieve the described protection, the power factor monitoring parameters (↳ “4.5.1.6.1.1 Generator Lagging Power Factor (Level 1 & 2)” or ↳ “4.5.1.6.1.1 Generator Lagging Power Factor (Level 1 & 2)”) have to be configured as shown below.

Generator power factor lagging level 1			Generator power factor lagging level 2		
ID	Text	Setting	ID	Text	Setting
2325	Monitoring	On	2331	Monitoring	On
2329	Limit	+0.700	2335	Limit	+0.500
2330	Delay	30.00 s	2336	Delay	1.00 s
2326	Alarm class	B	2332	Alarm class	E
2327	Self acknowledge	No	2333	Self acknowledge	No
2328	Enabled	Yes	2334	Enabled	Yes

Generator power factor leading level 1			Generator power factor leading level 2		
ID	Text	Setting	ID	Text	Setting
2375	Monitoring	On	2381	Monitoring	On
2379	Limit	-0.800	2385	Limit	-0.600
2380	Delay	30.00 s	2386	Delay	1.00 s

Generator power factor leading level 1			Generator power factor leading level 2		
ID	Text	Setting	ID	Text	Setting
2376	Alarm class	B	2382	Alarm class	E
2377	Self acknowledge	No	2383	Self acknowledge	No
2378	Enabled	Yes	2384	Enabled	Yes

6.3.2 Configuring A Setpoint Control Via Analog Input

The following example illustrates how to configure an easYgen to use an external load setpoint via analog input [AI 03].

The external setpoint may be enabled using a switch, wired to discrete input [DI 09].

An analog 0 to 20 mA input is to be used where 4 mA corresponds with 0 % power (0 MW), 12 mA corresponds with 50 % power (1 MW), and 20 mA corresponds with 100 % power (2 MW).

Configuring the rated generator power

⚙️

1. ▷ Either on the front panel or using ToolKit navigate to menu [Configure measurement].
2. ▷ Configure the parameter listed in [Table 111](#).

ID	Parameter	Value	Comment
1752	Gen. rated active power [kW]	2000	Generator rated power of 2 MW

Table 111: Parameters for rated generator power

Configuring the analog input for real power setpoint

⚙️

1. ▷ Either on the front panel or using ToolKit navigate to menu [Parameter / Configuration / Configure application / Configure inputs/outputs / Configure analog inputs / Analog input 3].
2. ▷ Configure the parameters listed below.

ID	Parameter	Value	Comment
1100	Type	Linearr	A user-defined linear characteristic curve is to be used
1101	User defined min display value	+0.00e0	A value of 0.00 is displayed at the minimum of the input range
1102	User defined max	+2000.00e3	A value of 2000.00e3 (= 2000000) is displayed at the maximum of the input range

ID	Parameter	Value	Comment
	display value		
1139	Sender value at display min.	4	The sender value at minimum display is 4 mA
1140	Sender value at display max.	20	The sender value at maximum display is 20 mA
1120	Sender type	0 - 20 mA	A 0 to 20 mA sender is used on the analog input
10116	Filter time constant	Off	No filter time constant is applied to the analog signal
1135	Exponent for protocol	0	The value of the analog input 3 is multiplied by $10^0=1$.
1103	Monitoring wire break	Low	If the analog signal falls below 2 mA, a wire break is indicated
1104	Wire break alarm class	Class B	An alarm of Class B will be issued in case of a wire break
1105	Self acknowledge wire break	No	A wire break is not automatically cleared after it has been repaired
3636	Bargraph minimum	+0.00	The start value for the bargraph display of the analog input is 0.00
3637	Bargraph maximum	+2000.00e3	The end value for the bargraph display of the analog input is 2000.00e3 (= 2000000)

3. ▷

Configure the following parameters using ToolKit. They facilitate a more detailed display of the analog value.

ID	Parameter	Value	Comment
1125	Description	ActivePower SP	Analog input [AI 03] is labeled with "ActivePower SP (%)" on the display
1134	Unit	%	The unit "%" is shown on the display.

Configuring the load controller

The load controller is to be configured that it uses a fixed load setpoint 1 of 2 MW unless a switch energizes discrete input [DI 04] for enabling a variable load setpoint 2, which is controlled by analog input [AI 03].



1. ▷

Either on the front panel or using ToolKit navigate to menu [Configure load control].

2. ▷

Configure the parameters listed below.

ID	Parameter	Value	Comment
5539	AM ActPower SP1 [kW]	Determined by	The internal power setpoint 1 is used as load setpoint 1

ID	Parameter	Value	Comment
		AnalogManager 81.05 [A1 = 05.54 Internal P setp1 [kW]]	
5526	Load setpoint 1	Import	The internal power setpoint 1 is a import power value
5520	Int. load control setpoint 1	2000.0 kW	The internal power setpoint 1 is configured to 2 MW
5540	AM ActPower SP2 [kW]	Pass through of: 06.03 Analog input 3	Analog input 3 is used as load setpoint 2
5527	Load setpoint 2	Steady	The internal power setpoint 1 is a import power value
5521	Int. load control setpoint 2	1000.0 kW	The internal power setpoint 1 is configured to 1 MW
12919 12998 12269	Setp. 2 load Setp. 3 load Setp. 4 load	FALSE	LogicsManagers are not enabling load setpoint 2, 3, 4

3. ▷

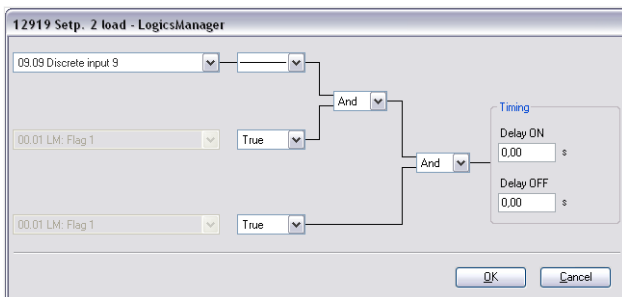

Fig. 274: LogicManager function "Setp. 2 load"

Configure the LogicManager function 12919 "Setp. 2 load" as shown in (↳ Fig. 274) to enable load setpoint 2 if discrete input [DI 09] is energized.

4. ▷

Continue similarly with setpoint 3 and setpoint 4

Viewing the load setpoint on the easYgen



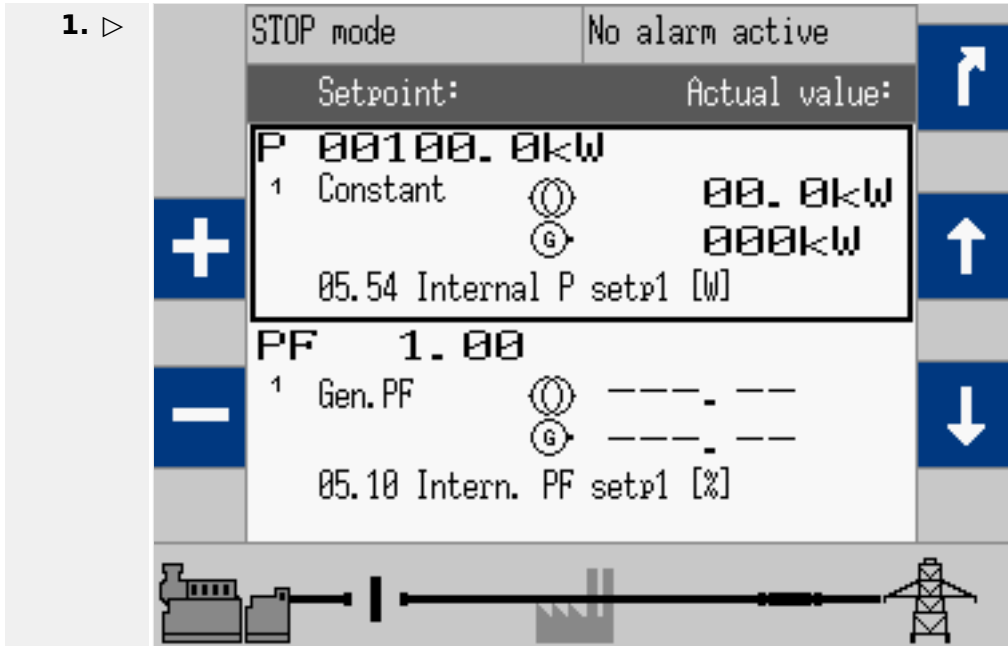

Fig. 275: Screen "Setpoint"

After the unit is configured as described above, the "Setpoint" screen may be viewed from the main screen by selecting [Next Page / Setpoints / Setpoints generator].

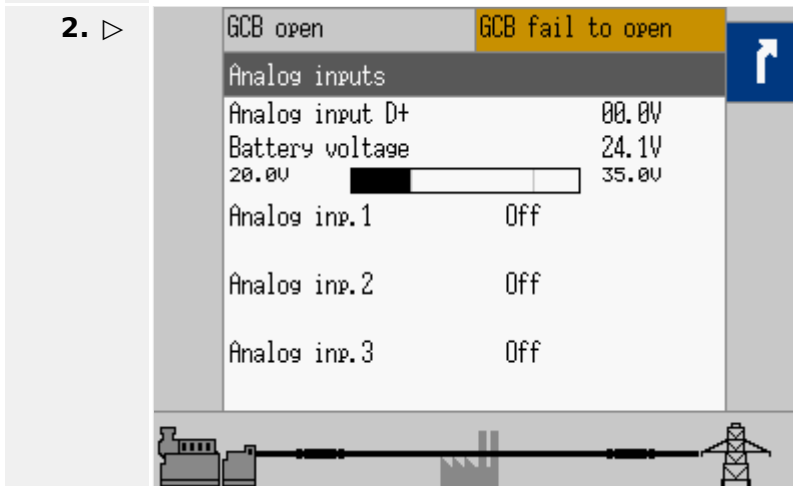



Fig. 276: Screen "Analog inputs"

The "Analog inputs" screen may be viewed from the main screen by selecting [Next Page / Measured values / Analog inputs/outputs].

6.3.3 Creating Self-Toggling (Pulsing) Relays



This function is set up with the LogicsManager.

This is a simple example of a relay output that toggles from energized to de-energized with adjustable on and off time.

In this example relay 2 is pulsing if

- "04.01 Operat. mode AUTO" and
- "01.08 Warning alarm" is active.

Configuring "Relay 2" for a pulsing relay

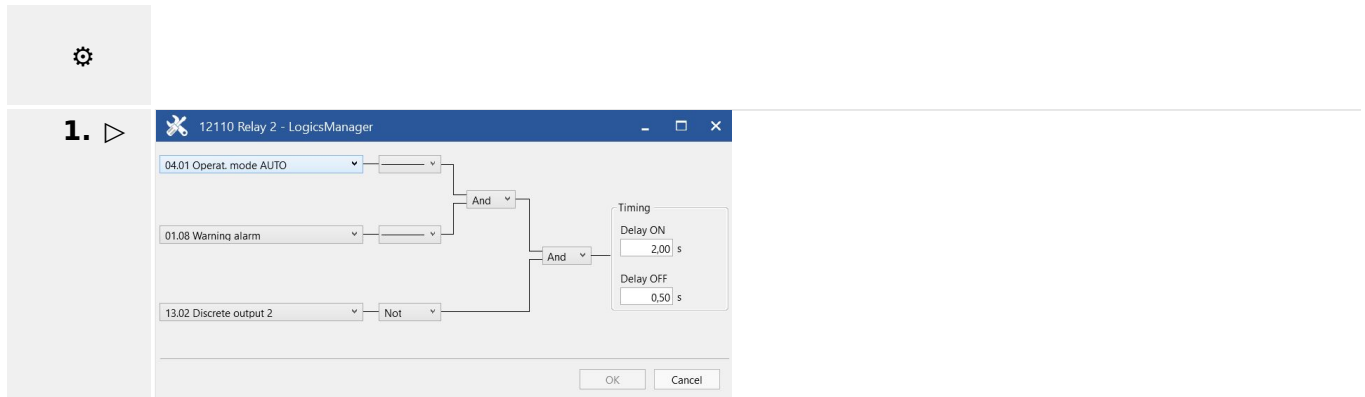



Fig. 277: LogicsManager function "Relay 2"

Configure the LogicsManager function "Relay 2" as shown in ( Fig. 277).

- ▶ In this example is the Delay ON time (2 s) in the LogicsManager determines how long the pause is, the Delay OFF time (0.5 s) the pulse duration.

6.3.4 Changing A Starter Battery Set



This function is set up with the LogicsManager.

The following programming example shows how two relay outputs are energized in turns when discrete input 9 is energized.

At first discrete output 11 will be energized, then, discrete output 12 will be energized, then discrete output 11 and so on.

This logic may be used to change between two starter battery sets for each starting cycle.

Configuration

Configure Relay 11 and Relay 12 as well as the Flags 2, 3, 4, and 5 as shown in the following example.

You may also use the discrete input, which starts the engine by default [DI 02] or any other input command instead of discrete input 9; for example the command variable "03.06 Engine released".



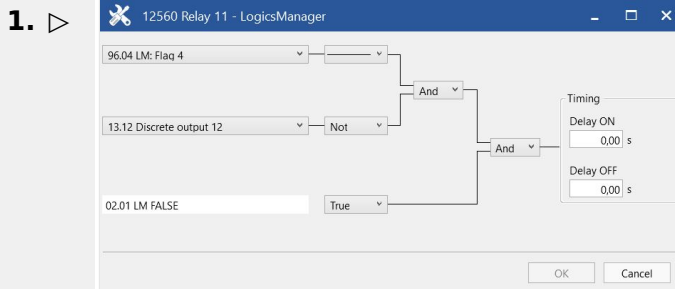

Fig. 278: LogicsManager function "Relay 11"

Configure the LogicsManager function "Relay 11" as shown in ([↪ Fig. 278](#)).

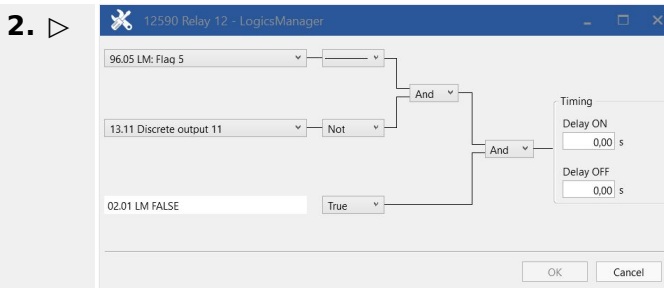

Fig. 279: LogicsManager function "Relay 12"

Configure the LogicsManager function "Relay 12" as shown in ([↪ Fig. 279](#)).

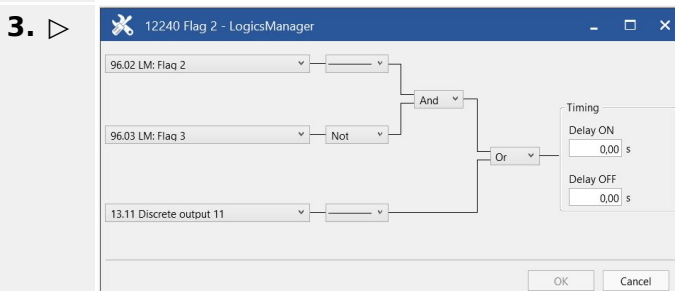

Fig. 280: LogicsManager function "Flag 2"

Configure the LogicsManager function "Flag 2" as shown in ([↪ Fig. 280](#)).

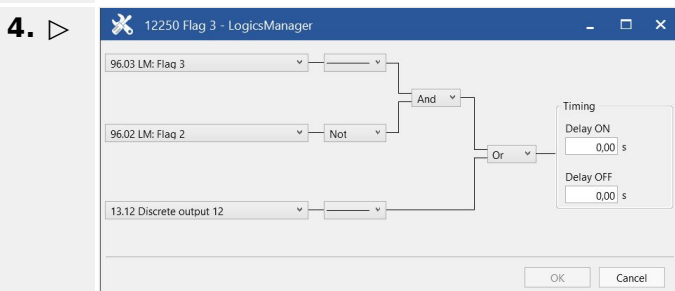

Fig. 281: LogicsManager function "Flag 3"

Configure the LogicsManager function "Flag 3" as shown in ([↪ Fig. 281](#)).

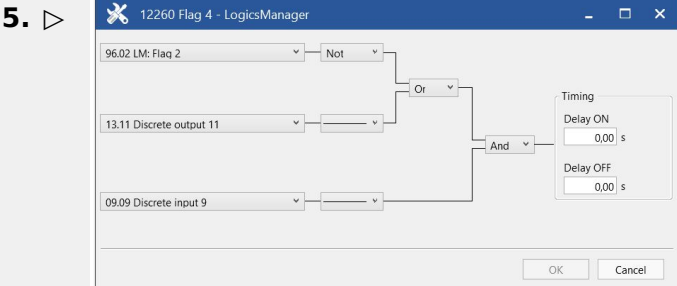

Fig. 282: LogicsManager function "Flag 4"

Configure the LogicsManager function "Flag 4" as shown in (↪ Fig. 282).

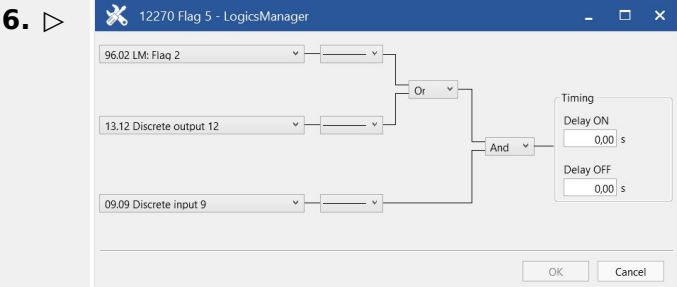



Fig. 283: LogicsManager function "Flag 5"

Configure the LogicsManager function "Flag 5" as shown in (↪ Fig. 283).

6.3.5 Performing Remote Start/Stop And Acknowledgment

The easYgen controller may be configured to perform start/stop/shutdown/ Acknowledgment functions remotely through the CAN bus or Modbus. The required procedure is detailed in the following steps.



Refer to ↪ [“4.1.1 Basic Navigation”](#) for a detailed description of the navigation through the various display screens.

A detailed description of the individual parameters may be found in ↪ [“4.4.5.2 Operation Mode AUTO - Automatic Run”](#).

Be sure to enter the password for code level 2 or higher to be able to access the required configuration screens.

Refer to ToolKit Manual for a description of the installation, configuration and usage of the ToolKit visualization and configuration application.



Preliminary Conditions

We recommend to reset the unit to factory settings before proceeding.

Refer to ↪ [“4.3.5 System Management”](#) for reference.

The LogicsManager factory settings are shown in ↪ [“9.3.5 Factory Settings”](#).

6.3.5.1 Operating Modes

Two operating modes may be used with remote control:

- AUTOMATIC
- STOP

It is possible to fix the operating mode using the LogicsManager function "86.16 LM: Operat. mode AUTO" (parameter [↩ 12510](#)).

AUTOMATIC

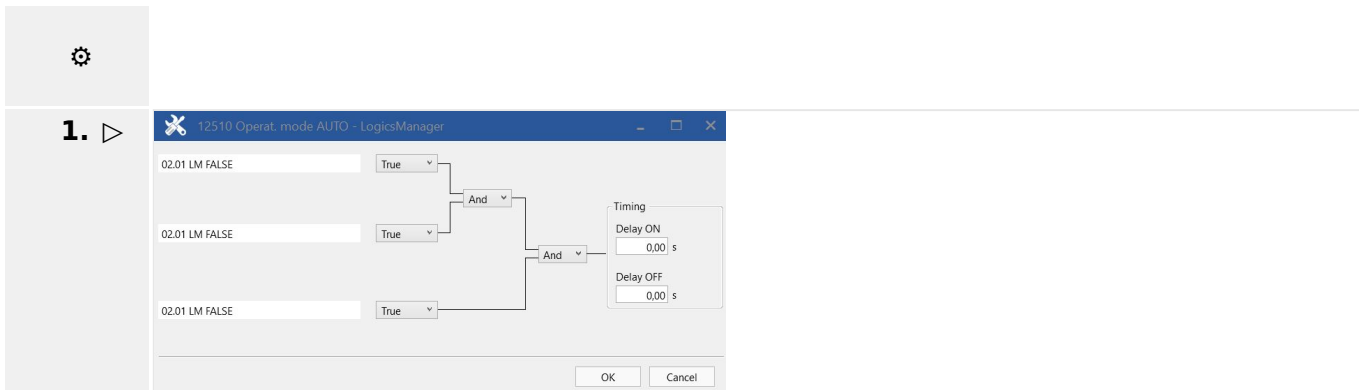

Fig. 284: LogicsManager function "Operat. mode AUTO"

The LogicsManager function ""Operat. mode AUTO"" (parameter [↩ 12510](#)) can be configured as shown in ([↩ Fig. 284](#)).

- ▶ AUTOMATIC operation mode is always enabled.

If an alarm of alarm class C through F occurs in AUTOMATIC operating mode, the control does not return to STOP operating mode. If the alarm is cleared after Acknowledgment a restart is initiated.

It is also possible to configure a discrete input for controlling the operating mode using the LogicsManager function "86.16 LM: Operat. mode AUTO" (parameter [↩ 12510](#)) and "86.18 LM: Operat. mode STOP" (parameter [↩ 12530](#)).

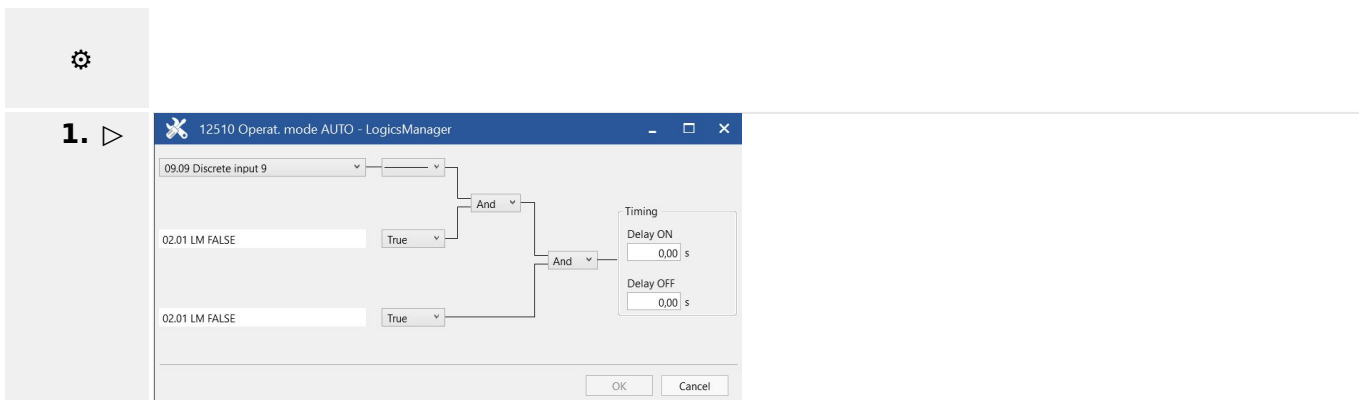



Fig. 285: LogicsManager function ""Operat. mode AUTO""

The LogicsManager function ""Operat. mode AUTO"" (parameter [↩ 12510](#)) can be configured as shown in ([↩ Fig. 285](#)).

- ▶ AUTOMATIC operation mode is enabled as soon as discrete input 9 is energized.

STOP



1. ▷

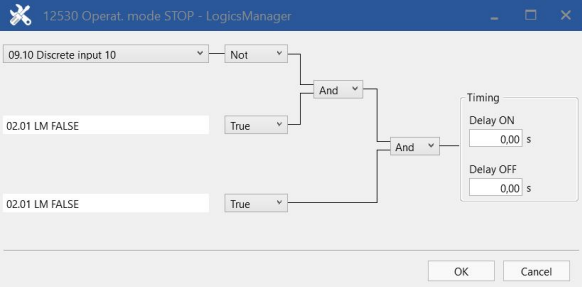

Fig. 286: LogicsManager function "Operat. mode STOP"

The LogicsManager function "Operat. mode STOP" (parameter [↩ 12530](#)) can be configured as shown in ([↩ Fig. 286](#)).

▶ STOP operation mode is enabled as soon as discrete input 10 is de-energized.

6.3.5.2 Setting Up A Test With Or Without Load

There are a lot of different opinions of the behavior of a proper test mode. The easYgen controller is supporting the following two modes:

- Test with load
- Test without load



Alternatives to the operation mode TEST

In cases the dedicated TEST operation mode shall be not taken, the following procedure can be taken to execute an TEST run in the operation mode AUTOMATIC.

Test with load

This is the LogicsManager function Start req. in AUTO (parameter [↩ 12120](#)). No special message appears on the display.

If the mains fail during start in auto, the unit keeps running until the mains return and the mains settling time is expired or the conditions for Start req. in AUTO are FALSE again. The result depends on which condition is active longer.

Test without load

This is the LogicsManager function "Start w/o load" (parameter  12540). If the conditions for this LogicsManager function are TRUE, the engine will provide an automatic starting sequence and keep the generator running until this function is FALSE again.

Then the unit will perform an automatic stop sequence and remain in standby in auto mode.

The message "Start w/o load" is displayed during the test without load. If the mains fails during test without load and the emergency mode is enabled, the unit will take over the load.

The unit will open the MCB and close the GCB. When the mains return, it will transfer the load back to the mains according to the configured breaker transition mode after the mains settling timer has expired. The engine will keep running until the conditions for "Start w/o load" are FALSE again.

Example for test without load

The engine shall start once a month and run for one hour without overtaking the load. The test day shall be every fifteenth of a month (with flag 2). A relay output can be configured to indicate if this test is running, e.g. for a signal lamp.

1. ▷ Configure the parameters listed below to set up the timer.

ID	Parameter	Value	Comment
1663	Active day	15	The active day is enabled every fifteenth of the month
1662	Active hour	10	The active hour is enabled between 10:00 and 11:00 am every day

Table 112: Timer configuration

2. ▷

Fig. 287: LogicsManager function "Flag 2"

Configure the LogicsManager function "Flag 2" (parameter ↪ 10701) as shown in (↪ Fig. 287).

▶ Flag 2 becomes TRUE as soon as the configured active day and active time is reached.

3. ▷

Fig. 288: LogicsManager function "Start without load"

The LogicsManager function "Start without load" (parameter ↪ 12540) can be configured as shown in (↪ Fig. 288).

▶ Start without load mode is enabled as soon as Flag 2 becomes TRUE.

6.3.5.3 Remote Start/Stop, Shutdown, And Acknowledgment

The easYgen may be start, stop, shut down, or acknowledged alarms with Modbus or CAN protocol via the interface.

Therefore, two logical command variables (04.13, 04.14 and 03.40) have to be configured with the LogicsManager.

- 04.13 Remote request
- 04.14 Remote acknowledge
- 03.40 Remote Shutdown

A 03.40 Remote Shutdown can be configured via LogicsManager internal flag (e.g.12230 Flag 1) combined with a free alarm LogicsManager (e.g. Free alarm 1) configured with shutdown alarm class.

How to handle a "04.13 Remote request" and a "04.14 Remote acknowledge" is described below in detail.

Start request in AUTOMATIC operating mode

⚙️

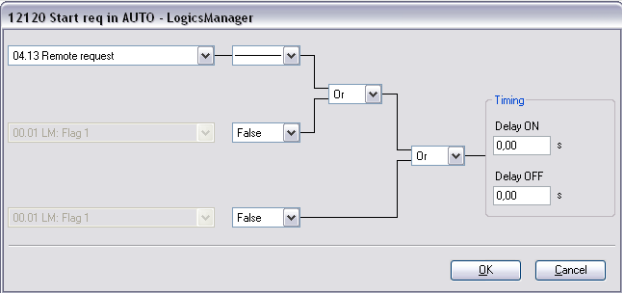
1. ▷ Either on the front panel or using ToolKit navigate to menu [PARAMETER / Configuration / Configure application / Configure operation modes / Operation mode AUTO].
2. ▷ Open the LogicsManager 12120 for entry "Start req. in AUTO".
3. ▷ 

▶ With this setting, the "Start req. in AUTO" LogicsManager output becomes TRUE as soon as the remote request signal is enabled.

Fig. 289: LogicsManager function "Start req. in AUTO"

Configure the LogicsManager function "Start req. in AUTO" as shown in (↪ Fig. 289).

 The LogicsManager commands 2 and 3 may be used to configure additional conditions like discrete inputs, which must be energized to be able to issue the remote start request.

External Acknowledgment



1. ▷ Either on the front panel or using ToolKit navigate to menu [PARAMETER / Configuration / Configure monitoring / Miscellaneous / General monitoring settings].
2. ▷ Open the LogicsManager "Ext. acknowledge":

3. ▷

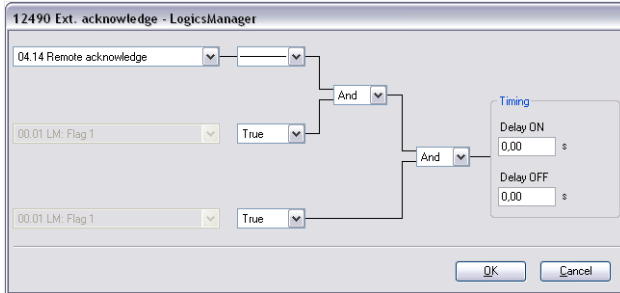

Fig. 290: LogicsManager function "Ext. acknowledge"

Configure the LogicsManager function "Ext. acknowledge" as shown in (↪ Fig. 290).

- ▶ With this setting, the "Ext. acknowledge" LogicsManager output becomes TRUE as soon as the remote acknowledge signal is enabled.



The LogicsManager commands 2 and 3 may be used to configure additional conditions like discrete inputs, which must be energized to be able to issue the remote acknowledge command.

Please refer to ↪ "6.5 Modbus Applications" for a description of how to configure the LogicsManager functions via Modbus.



All interfaces access the same bits. The command variable "04.13 Remote request" remains enabled in the easYgen until a new command is sent or the power supply failed or is removed.

Remote start:

- The command variable "04.13 Remote request" changes to "1" (high) if the start bit (ID 503, bit 0) changes from "0" to "1".
- The command variable "04.13 Remote request" changes to "0" (low) if the stop bit (ID 503, bit 1) changes from "0" to "1" (↪ Fig. 291).

Acknowledgment:

- The command variable "04.14 Remote acknowledge" reflects the Acknowledgment bit (ID 503, bit 4).
- An Acknowledgment is generally performed twice:
 - 1st change of the logical output "86.15 LM: Ext. acknowledge" from "0" to "1":
Silence horn
 - 2nd change of the logical output "86.15 LM: Ext. acknowledge" from "0" to "1":

Acknowledges all inactive alarms

System reaction



The easYgen does NOT react on the disabling of the start bit, but only on the enabling of the stop bit.

This has the advantage that it is not required to maintain the connection established for the whole time in case of a remote start.

The following figure shows the reaction of the command variable on the various changes of the bits:

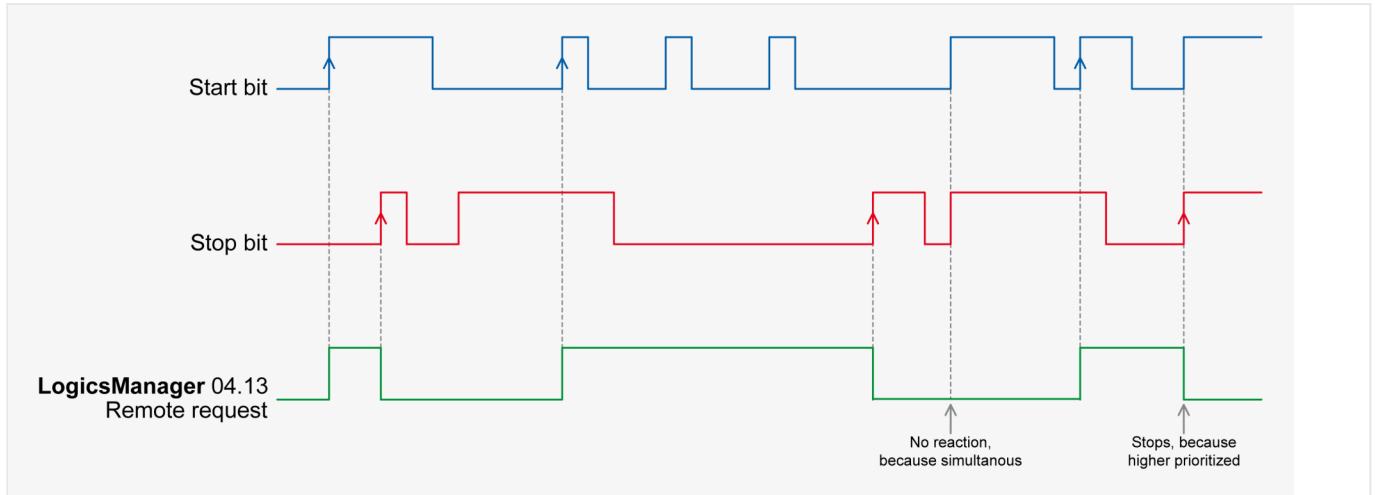

Fig. 291: Command variable

Enabling the bits may be performed with the following methods:

- Bit Enabling via Modbus Protocol and RS-485 Interface
- Bit Enabling via CANopen Protocol and CAN Interface 1

Bit enabling via Modbus protocol and RS-485 interface

The parameter Modbus Slave ID must be configured.

The control bits are sent on address 503 for a start via Modbus:

- Bit 0: Start
- Bit 1: Stop
- Bits 2 and 3: must be "0" (for the watchdog).
- Bit 4: Acknowledgment
- Bit 9: Shutdown command



Please refer to [6.5 Modbus Applications](#) for a description of how to enable control bits via Modbus.

Bit enabling via CANopen protocol and CAN interface 1



For further information on the CANopen protocol refer to [↗](#) “7.4 CANopen Protocol” and the CANopen file *.eds, which is delivered with the unit.

Please refer to [↗](#) “6.5 Modbus Applications” for a description of how to enable control bits via Modbus.

Remote Shutdown

For controlling the device with 03.40 Remote Shutdown please run setup as described above but with 03.40 instead of 04.14 and using Bit 9 instead of Bit 0, 1, and 4.

Additionally

- define a free LM flag for "03.40 Remote Shutdown" and
- take it as input for a Free alarm
- with a shutdown alarm class.

6.3.6 Connecting IKD 1, IKD-IN-16 and IKD-OUT-16 on CAN Bus



We recommend to connect external expansion boards, like the Woodward IKD 1 (or IKD-IN-16, IKD-OUT-16) to CAN bus 2. This CAN bus offers preconfigured settings for operating several expansion boards including these IKDs.

However, it is also possible to connect these IKDs to CAN bus 1.

Refer to the [↗](#) “4.7.4.1.3 Transmit PDO {x} (Process Data Object)” and [↗](#) “4.7.4.1.2 Receive PDO {x} (Process Data Object)” for the configuration of the parameters concerned.

Refer also to [↗](#) “7.4 CANopen Protocol” for a description of the data objects.

The easYgen may either be configured directly using the front panel or externally using the Toolkit software.



Special notes for applications with IKD-IN-16 or IKD-OUT-16:

IKD-IN-16 has 16 digital inputs channels and IKD-OUT-16 has 16 digital channels in contrast to IKD 1 which has inputs **and** outputs but only 8 channels each. For this reason, for IKD-IN-16 or IKD-OUT-16 the configuration must be done for the first IKD and the second IKD. Refer to:

- Configure first IKD [↗](#) “6.3.6.1 Configuration for the first IKD 1”
- Configure 2nd IKD [↗](#) “6.3.6.3 Configuration for a second IKD 1”

If **only IKD-IN-16** is connected, only RPDOs for first and second IKD must be configured as described below. (No need to configure TPDO.)

If **only IKD-OUT-16** is connected, only TPDOs for first and second IKD must be configured as described below. (No need to configure RPDO.)

6.3.6.1 Configuration for the first IKD 1

Transmit PDO

The easYgen must be configured for sending to data protocol 65000 (external DOs 1 to 8) and CAN ID 181 (hex) every 20 ms on TPDO1.

TPDO is used to send messages to an external device.

ID	Parameter	Value	Comment
9600	COB-ID	181 (hex) / 385 (dec)	The COB-ID is configured to 181 (hex) or 385 (dec)
9602	Transmission type	255	Data is automatically broadcasted (transmission type 255)
9604	Event timer	20 ms	The event timer is configured to 20 ms
8962	Selected Data Protocol	65000	Data protocol 65000 is selected

Table 113: TPDO1 configuration

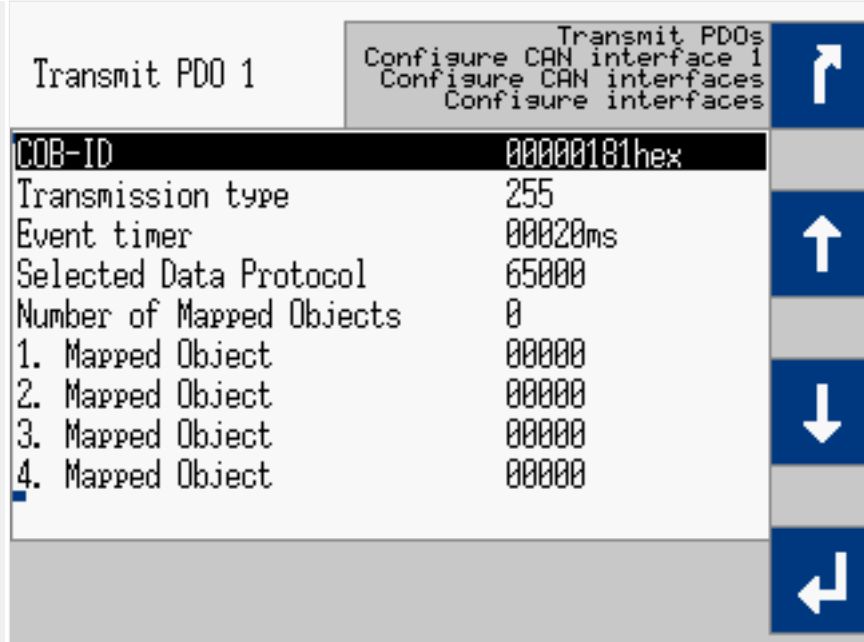

Fig. 292: TPDO configuration for IKD 1 (example HMI)

Transmit PDO 1

9600 COB-ID	<input type="text" value="385"/>	dec
9602 Transmission type	<input type="text" value="255"/>	
9604 Event timer	<input type="text" value="20"/>	ms
8962 Selected Data Protocol	<input type="text" value="65000"/>	
9609 Number of Mapped Objects	<input type="text" value="0"/>	
9605 1. Mapped Object	<input type="text" value="0"/>	
9606 2. Mapped Object	<input type="text" value="0"/>	
9607 3. Mapped Object	<input type="text" value="0"/>	
9608 4. Mapped Object	<input type="text" value="0"/>	

Fig. 293: TPDO configuration for IKD 1 (example ToolKit)

↳ Fig. 292 and ↳ Table 113 display the example TPDO configuration for IKD 1.

Receive PDO

The easYgen must be configured for receiving data on an RPDO. The data received on CAN ID 201h is interpreted as data protocol 65000 (external DIs 1 to 8).

⚙️

1. ▷ Configure RPDO1 as shown below.

ID	Parameter	Value	Comment
9300	COB-ID	201 (hex) / 513 (dec)	The COB-ID is configured to 201 (hex) or 513 (dec)
9121	Event timer	2000 ms	The event timer is configured to 2000 ms
8970	Selected Data Protocol	65000	Data protocol 65000 is selected

Table 114: RPDO1 configuration

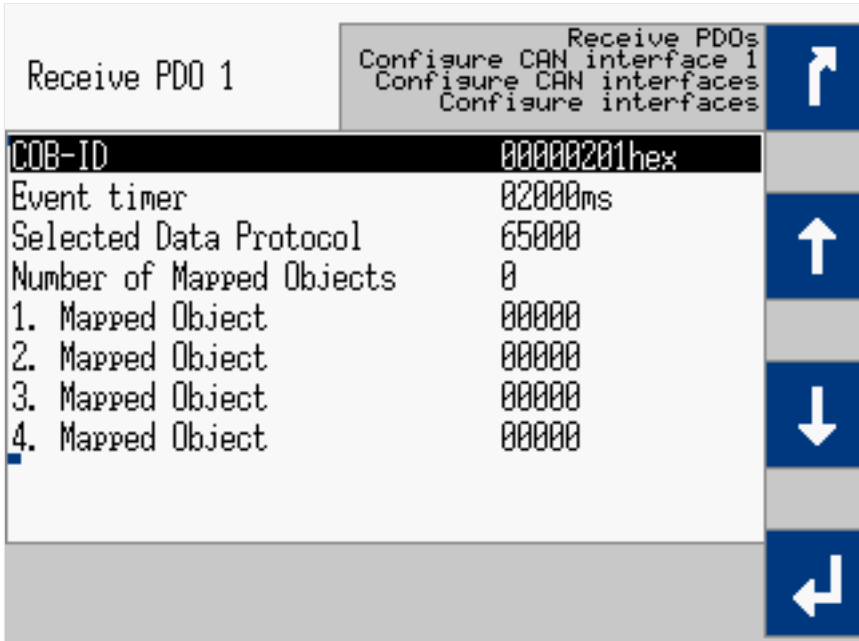

Fig. 294: RPDO configuration for the first IKD (example HMI)

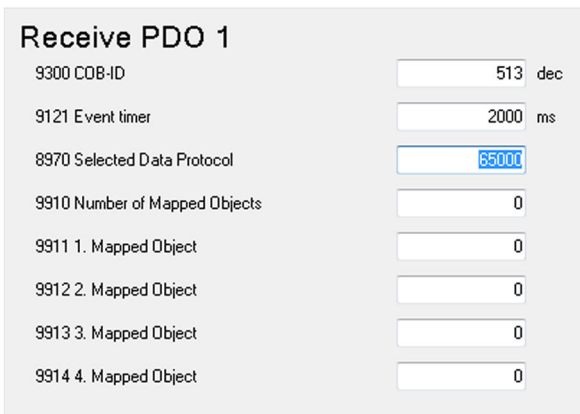

Fig. 295: RPDO configuration for the first IKD (example ToolKit)

↳ Fig. 294 and ↳ Table 114 display the example RPDO configuration for IKD 1.

6.3.6.2 IKD Configuration Tool

General notes

The IKD 1 is a Woodward I/O expansion board with 8 digital inputs and 8 digital outputs. It can be connected via CAN bus to Woodward easYgen generator controllers or DTSC 200 Automatic Transfer Switch Controllers. The configuration of the IKD 1 can be done with the IKD Configuration Tool running on a PC/laptop, connected via serial interface to the IKD 1.

IKD Configuration Tool (P/N: 9927-2094) is a tool to quickly configure an IKD for connection with the easYgen series or DTSC 200. It will check the parametrization of the IKD 1 and allows to set it to one of the four different connection modes. The IKD Configuration Tool replaces the LeoPC configuration tool.

Note: This tool cannot be used for **IKD-IN-16** and **IKD-OUT-16**. (These devices have Dip switches for configuration.)

Installation prerequisites

The following items are necessary before installing the software:

- PC with Windows operating system
- To connect the IKD to a serial port (RS232) on the PC
 - Woodward DPC cable RS-232 (P/N: 5417-557)
- To connect the IKD to a USB port on the PC
 - USB/RS-232 adaptor and a Woodward DPC cable RS-232 (P/N: 5417-557)
 - Woodward DPC cable USB/RS-232 (P/N: 5417-1251)



Installation



The following steps need to be performed for installing the IKD Configuration Tool

1. ▷ Uninstall any previous installation of IKD Configuration Tool
2. ▷ Download IKD Configuration Tool from Woodward web site
3. ▷ Unzip the *.zip file on your PC
 - ▶ You should get a directory named “publish”
4. ▷ Run the “setup.exe” from this directory
5. ▷ Follow the instructions given during installation
6. ▷ After installation the directory “publish” can be deleted



How to use the Configuration Tool



The following steps allow push-button configuration of IKD 1

1. ▷ Connect the IKD 1 to the PC/laptop as described above and power it
2. ▷ Start the already installed IKD Configuration Tool “ConfigIKD”
3. ▷ Select the COM port IKD 1 is connected to the PC/laptop
4. ▷ Press button “Connect” to connect to the IKD 1
5. ▷ Select CAN baud rate
6. ▷ Press one of the four preconfigured mode buttons (“IKD 1 on Node-ID x”)
 - ▶ Settings will be transferred to the IKD 1

The Program Dialog Box

On start of the configuration software, you should get the following screen with fields, buttons and selectors available:



Configuring an IKD

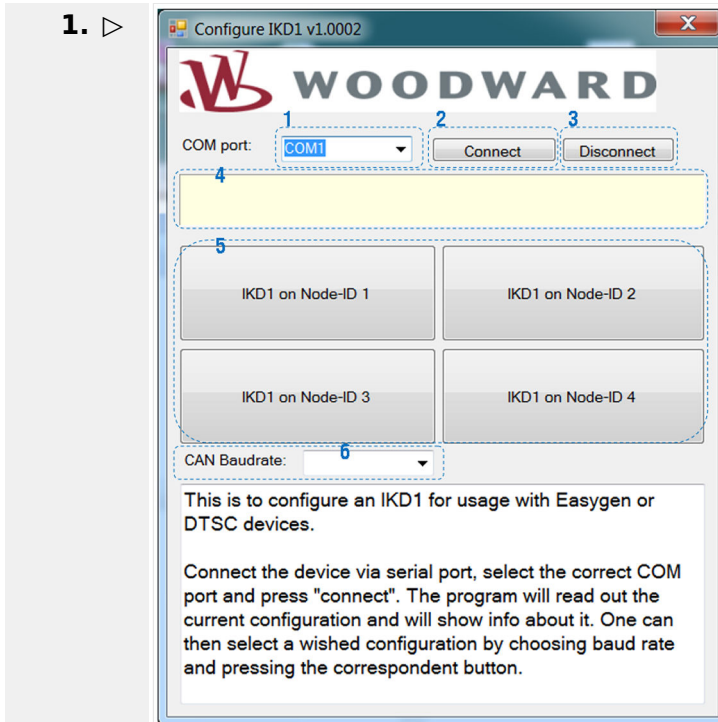

Fig. 296: IKD Configuration Tool

»COM port«

- ▶ Select between all serial ports your PC is providing. If there is no serial port available, then this field is empty. Select the COM port to which the IKD is connected. ("COM1" for example)

2. ▶ »Connect«

- ▶ Opens the selected serial port and tries to connect to the IKD. If successful, it will read out the data from the IKD but it won't change any data on the IKD. It will populate the "CAN Baud rate" field with the CAN baud rate the IKD is currently configured. If the IKD is already configured to one of the four different CAN node-IDs usable for an easYgen, the corresponding button "IKD 1 on Node-ID x" will be colored green.

3. ▶ »Disconnect«

- ▶ Closes the serial port if it was opened. Must be used, if accidentally the wrong COM port was selected and connected

4. ▶ »Status field« (yellow background)

- ▶ Shows messages about the status of the connection

5. ▶ »IKD on Node-ID X«

- ▶ Each of these four buttons has two functionalities:
 1) After connecting, if the IKD 1 is already configured to one of the four different CAN node-IDs usable for an easYgen, the corresponding button will be colored green.
 2) By pressing the button the program will configure the IKD 1 to the selected node-ID and CAN baud rate. After that it will read it out for check.

6. ▶ »CAN Baud rate«

- ▶ This button has two functionalities:
 1) After connecting it shows the currently configured CAN baud rate of the IKD.

2) It can also be used to select the CAN baud rate. For the easYgen configuration only 125 kBaud, 250 kBaud and 500 kBaud is permissible.

6.3.6.3 Configuration for a second IKD 1

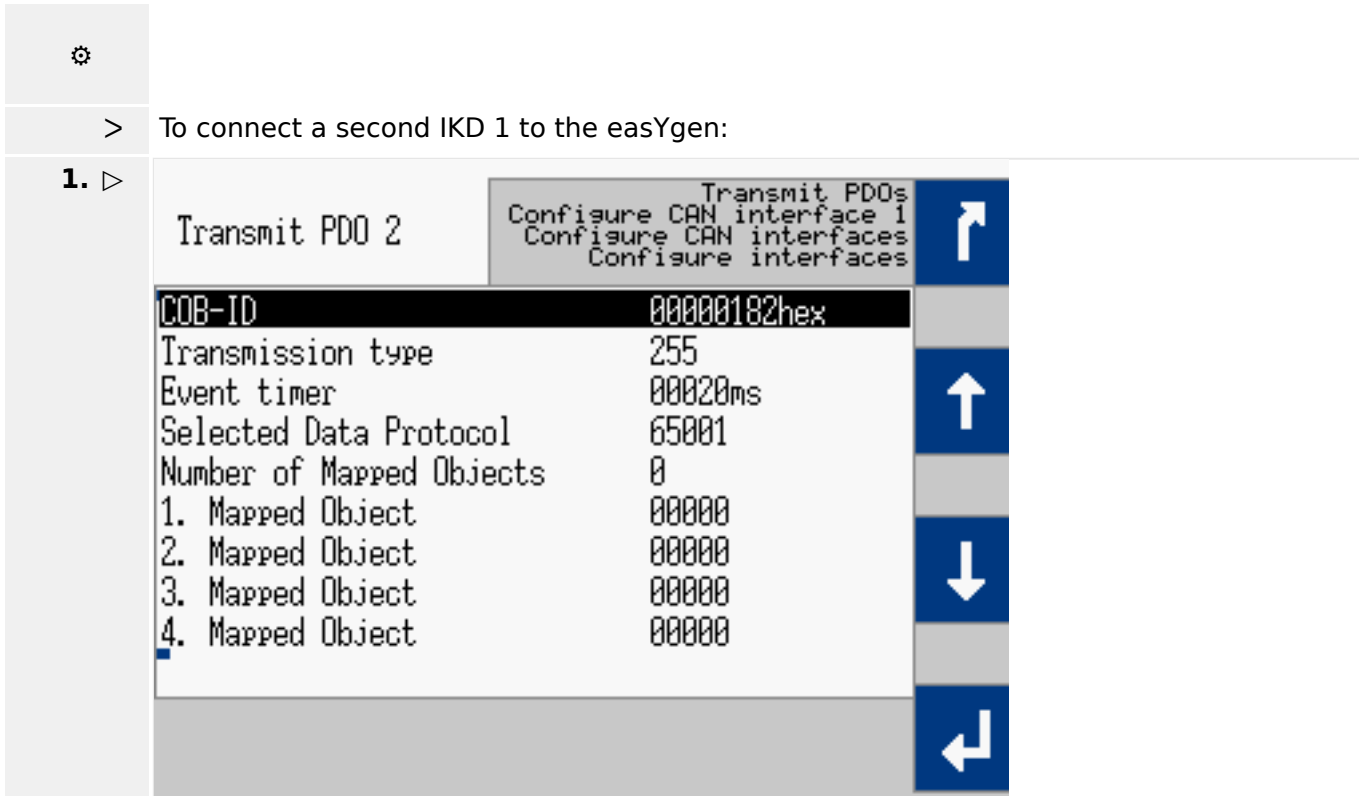

Fig. 297: TPDO configuration for the 2nd IKD 1 (example HMI)

Set up TPDO2 for the easYgen on the front panel as shown in (↪ “Transmit PDO”).

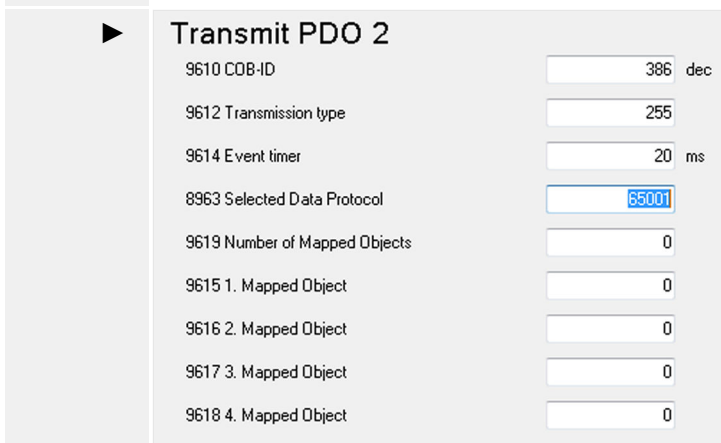

Fig. 298: TPDO configuration for the 2nd IKD 1 (example ToolKit)

Set up TPDO2 for the easYgen in ToolKit as shown in (↪ “Transmit PDO”).

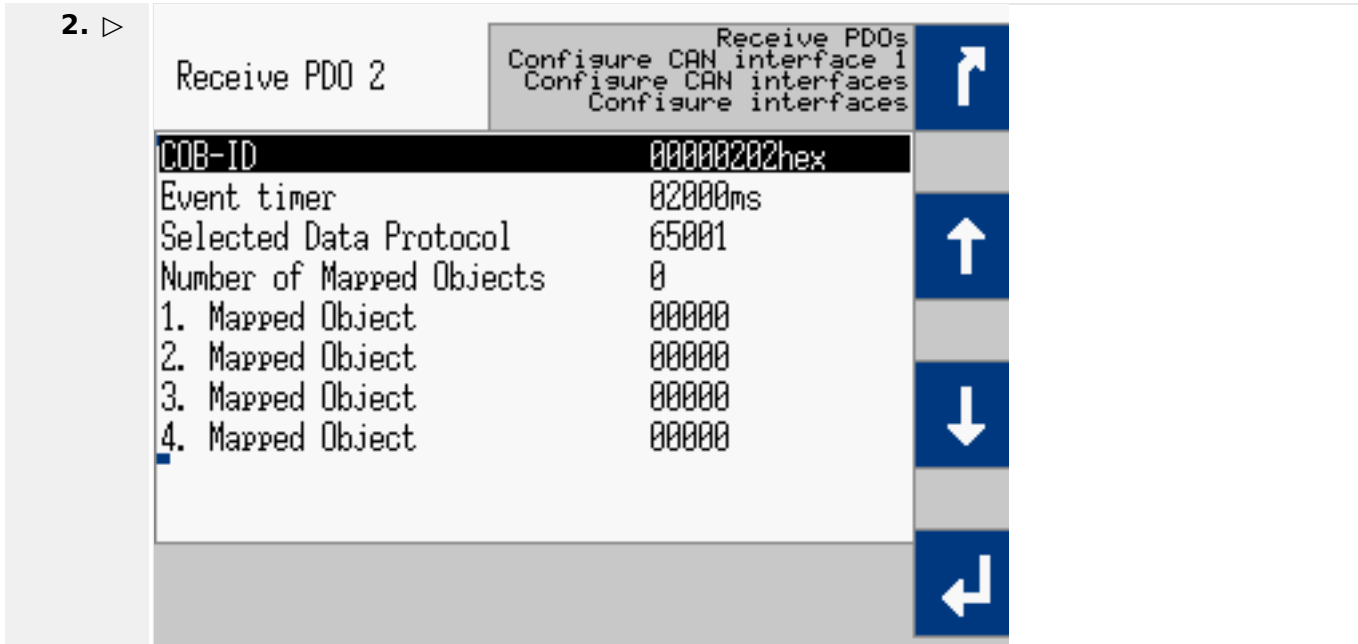

Fig. 299: RPDO configuration for 2nd IKD 1 (example HMI)

Set up RPDO2 for the easYgen on the front panel as shown in (↩️ “Receive PDO”).

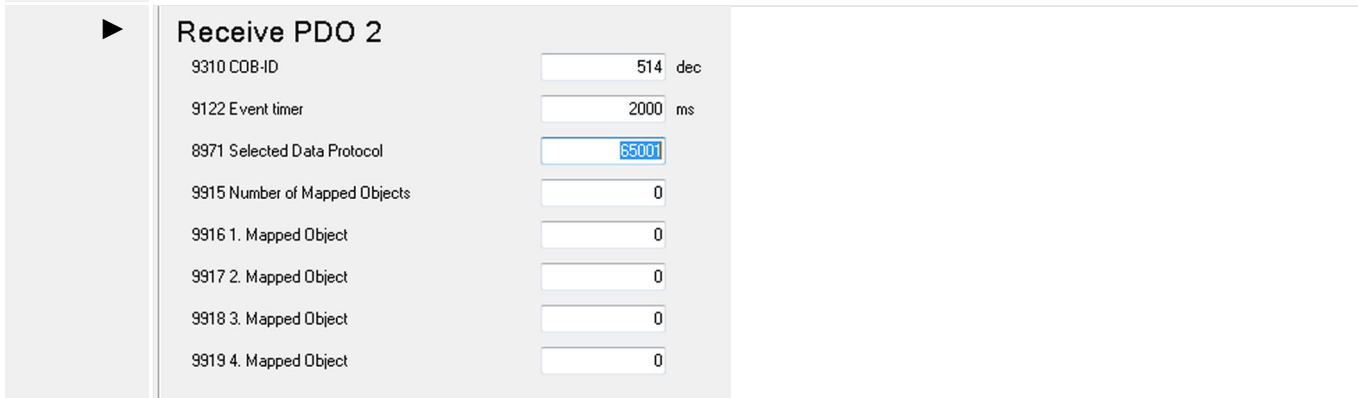

Fig. 300: RPDO configuration for 2nd IKD 1 (example ToolKit)

Set up RPDO2 for the easYgen in ToolKit as shown in (↩️ “Receive PDO”).

6.3.7 Connecting easYlite-200 on CAN Bus

A easYlite-200 device can be used as remote control to annunciate configurable states and alarms.

If connecting an external horn to the relay output the easYlite-200 can also be used as remote alarm audible device.

The easYgen-XT can configure up to 16 LEDs for each easYite-200 (device 1 and 2).

The configured LED states, the annunciation modes (flashing, color) and the active horn signal (new alarm) are transmitted over the configured CAN interface (1,2,3) to the easYlite-200.

NOTICE!



Do not connect more than one easYgen-XT together with the easYlite-200 devices on the same CAN connection.
This will lead to unexpected behavior at the easYite-200 devices.



Configuration hints:

The configuration (behavior of the LEDs, CAN selection) for the easYlite-200 is only possible via ToolKit.

For the configuration of the digital output of the easYlite-200 (as "Horn", "Com. fail" or "Horn or Com. fail") and the device 1 or device 2, the easYlite itself must be configured with "ToolKit-SC" via USB.

By default the easYlite-200 itself is configured:

- Module = "Module 1" (Device 1); **For use as Device 2, the easYlite-200 must be configured via ToolKit-SC as "Module 2".**
- CAN baud rate = 250 kb
- Output = "Horn"

If these default settings match your application, no configuration with ToolKit-SC is necessary for the use as Device **1**.





For further information about the easYlite-200 please refer to the easYlite-200 manual.

The following tables show the different parameters to configure the easYlite-200 device 1 and 2.

↳ Table 116 and ↳ Table 119 show the parameter for LED1 of each device (1 and 2). The LED2 to 16 are configured accordingly. The parameter IDs of LED1 to 16 are listed each below.

easYlite-200 device 1 parameter

[PARAMETER / Configure HMI / Configure Others / easYlite-200 Device 1].

ID	Parameter	CL	Setting range [Default]	Description
767	Horn reset allowed	2	Yes [No]	 This parameter defines if the easYgen-XT horn acknowledge is allowed via easYlite-200. If set to "Yes", the mute button on the easYlite-200 device 1 will acknowledge the horn in the easYgen-XT.
761	CAN1	2	On	

ID	Parameter	CL	Setting range [Default]	Description
			[Off]	If this parameter is set to "On", the easYgen-XT will communicate via CAN1 with the easYlite-200 device 1.
762	CAN2	2	On [Off]	 If this parameter is set to "On", the easYgen-XT will communicate via CAN2 with the easYlite-200 device 1.
763	CAN3	2	On [Off]	 If this parameter is set to "On", the easYgen-XT will communicate via CAN3 with the easYlite-200 device 1.

Table 115: easYlite-200 device 1 communication parameter





ID	Parameter	CL	Setting range [Default]	Description
601	LED 1 source	2	[2.01]	 This parameter defines the source for LED 1 at the easYlite-200 device 1. The source can be any LogicsManager command variable by entering the according group number.
602	LED 1 logic	2	N.C. [N.O.]	 This parameter defines the logic for LED 1 at the easYlite-200 device 1. The logic is combined with the defined source before sending to the easYlite-200 device.
603	LED 1 flash	2	Slow flashing Steady [Fast flashing]	 This parameter defines the flash option for LED 1 at the easYlite-200 device 1.
604	LED 1 color	2	Red Yellow [Green]	 This parameter defines the color for LED 1 at the easYlite-200 device 1.

Table 116: easYlite-200 device 1 LED configuration

LED #	Source	Logic	Flash Option	Color
1	601	602	603	604

LED #	Source	Logic	Flash Option	Color
2	606	607	608	609
3	611	612	613	614
4	616	617	618	619
5	621	622	623	624
6	626	627	628	629
7	631	632	633	634
8	636	637	638	639
9	641	642	643	644
10	646	647	648	649
11	651	652	653	654
12	656	657	658	659
13	661	662	663	664
14	666	667	668	669
15	671	672	673	674
16	676	677	678	679



Table 117: LED 1 -16 easYlite-200 device 1 - parameter IDs

easYlite-200 device 2 parameter



For use as Device2, the easYlite-200 itself must be configured via ToolKit-SC as "Module 2"

[PARAMETER / Configure HMI / Configure Others / easYlite-200 Device 2].

ID	Parameter	CL	Setting range [Default]	Description
768	Horn reset allowed	2	Yes [No]	 <p>This parameter defines if the easYgen-XT horn acknowledge is allowed via easYlite-200. If set to "Yes", the mute button on the easYlite-200 device 2 will acknowledge the horn in the easYgen-XT.</p>
764	CAN1	2	On [Off]	 <p>If this parameter is set to "On", the easYgen-XT will communicate via CAN1 with the easYlite-200 device 2.</p>
765	CAN2	2	On [Off]	 <p>If this parameter is set to "On", the easYgen-XT will communicate</p>

ID	Parameter	CL	Setting range [Default]	Description
				via CAN2 with the easYlite-200 device 2.
766	CAN3	2	On [Off]	 If this parameter is set to "On", the easYgen-XT will communicate via CAN3 with the easYlite-200 device 2.

Table 118: easYlite-200 device 2 communication parameter





ID	Parameter	CL	Setting range [Default]	Description
681	LED 1 source	2	[2.01]	 This parameter defines the source for LED 1 at the easYlite-200 device 2. The source can be any LogicsManager command variable by entering the according group number.
682	LED 1 logic	2	N.C. [N.O.]	 This parameter defines the logic for LED 1 at the easYlite-200 device 2. The logic is combined with the defined source before sending to the easYlite-200 device.
683	LED 1 flash	2	Slow flashing Steady [Fast flashing]	 This parameter defines the flash option for LED 1 at the easYlite-200 device 2.
684	LED 1 color	2	Red Yellow [Green]	 This parameter defines the color for LED 1 at the easYlite-200 device 2.

Table 119: easYlite-200 device 2 LED configuration

LED #	Source	Logic	Flash Option	Color
1	681	682	683	684
2	686	687	688	689
3	691	692	693	694
4	696	697	698	699
5	701	702	703	704
6	706	707	708	709

LED #	Source	Logic	Flash Option	Color
7	711	712	713	714
8	716	717	718	719
9	721	722	723	724
10	726	727	728	729
11	731	732	733	734
12	736	737	738	739
13	749	670	671	672
14	746	747	748	748
15	751	752	753	754
16	756	757	758	759

Table 120: LED 1 -16 easYlite-200 device 2 - parameter IDs

6.3.8 Configuring A PWM Duty Cycle For A CAT ADEM Controller

If a PWM signal shall be used with a CAT ADEM speed controller, the duty cycle must be limited between 10% and 85%.

For this, the following settings must be made to the respective analog output



The following parameter IDs and figures refer to analog output 1.

Note, that another analog output may also be used.



1. ▷ Configure the parameters as shown below.

ID	Parameter	Value	Comment
5200	AM Data source AO1	11.03 Speed bias [%]	A speed signal will be output
5201	Selected hardware type	PWM	A PWM hardware type will be used
5208	Minimum hardware level	10.00%	The minimum output value is 10%
5209	Maximum hardware level	85.00%	The minimum output value is 85%
5210	PWM output level	10.00 V	The PWM output level is configured to 10 V

Table 121: PWM duty cycle configuration

- ▶ The finished configuration in ToolKit is shown in (Fig. 301).

6 Application Field

6.3.8 Configuring A PWM Duty Cycle For A CAT ADEM Controller

The screenshot displays the Woodward ToolKit software interface for configuring an analog output. The main window title is "EG3000XT.wtool - Woodward ToolKit". The breadcrumb path is "PARAMETER::Configuration::Configure application::Configure inputs/outputs::Configure analog outputs::Analog output 1".

The interface is divided into several sections:

- Device:** Shows "1" in a box.
- Navigation:** Includes buttons for HOME PAGE, ALARM STATUS, PARAMETER (selected), STATUS MENU, and Measured values / Analog outputs.
- Configure analog outputs:** The main configuration area for "Analog output 1".
 - 5201 Selected hardware type: PWM (dropdown)
 - 10310 Analog output 1: 47.50 (text field)
 - Hardware range:
 - 5208 Minimum hardware level: 10.00 (text field)
 - 5209 Maximum hardware level: 85.00 (text field)
 - 5210 PWM output level: 10.00 V (text field)
 - 5204 Source value at minimum level: 0.00 (text field)
 - 5206 Source value at maximum level: 100.00 (text field)
 - 5203 Filter time constant: Off (dropdown)
- Analog manager:** A sub-window for configuring the data source and filter.
 - 5200 AM Data source AO1:
 - A1: 11.03 Speed bias (%) (dropdown)
 - A2: 10.01 ZERO (dropdown)
 - C1: 0 (text field)
 - L1: 02.01 LM FALSE (dropdown)
 - L2: 02.01 LM FALSE (dropdown)
 - Type: Pass through (dropdown)
 - Output: 9704 93.01 AM Data source AO1
 - Diagram: A step function graph labeled "PASS THROUGH" with axes A_u and L_u.
 - Buttons: Apply, Cancel

Fig. 301: PWM duty cycle for a CAT ADEM controller (example ToolKit)

6.3.9 Wiring Self Powered Discrete Inputs



> In order to create self-powered discrete inputs with plastic housing variant:

1. ▷ Connect battery negative (B-) to ground and PE (terminal 61).

2. ▷

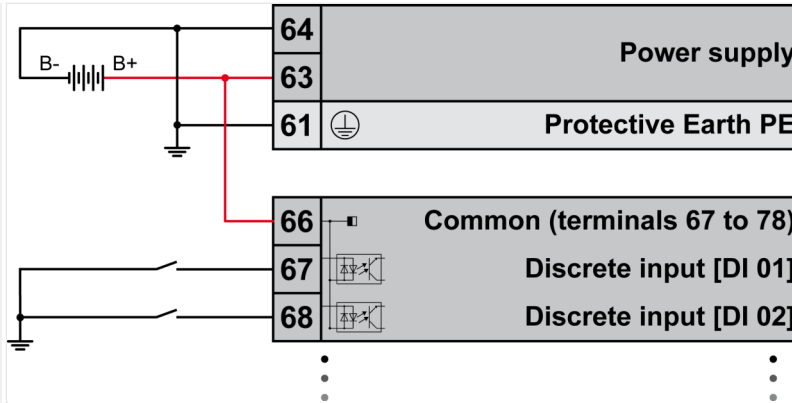

Fig. 302: Wiring self-powered discrete inputs

Connect DI common (terminal 66) to power supply 12/24 V (terminal 63, minimum wire size 0.5 mm² (20 AWG)).

▶ This enables to energize the discrete inputs against ground.



The Protective Earth terminal 61 is not connected on the sheet metal housing.

- Use the protective earth (PE) connector located at the bottom center of the sheet metal housing instead.

6.3.10 Connecting Analog Inputs In Series

The analog inputs of the easYgen-3000XT series are galvanically isolated to the power supply. This allows for example to share a power setpoint 0/4 to 20 mA with three devices.



Make sure that the source can drive the resulting burden. (Internal load: AI 1-AI 3 approx. 50 Ω, AI 4 - AI 6 approx. 249 Ω)

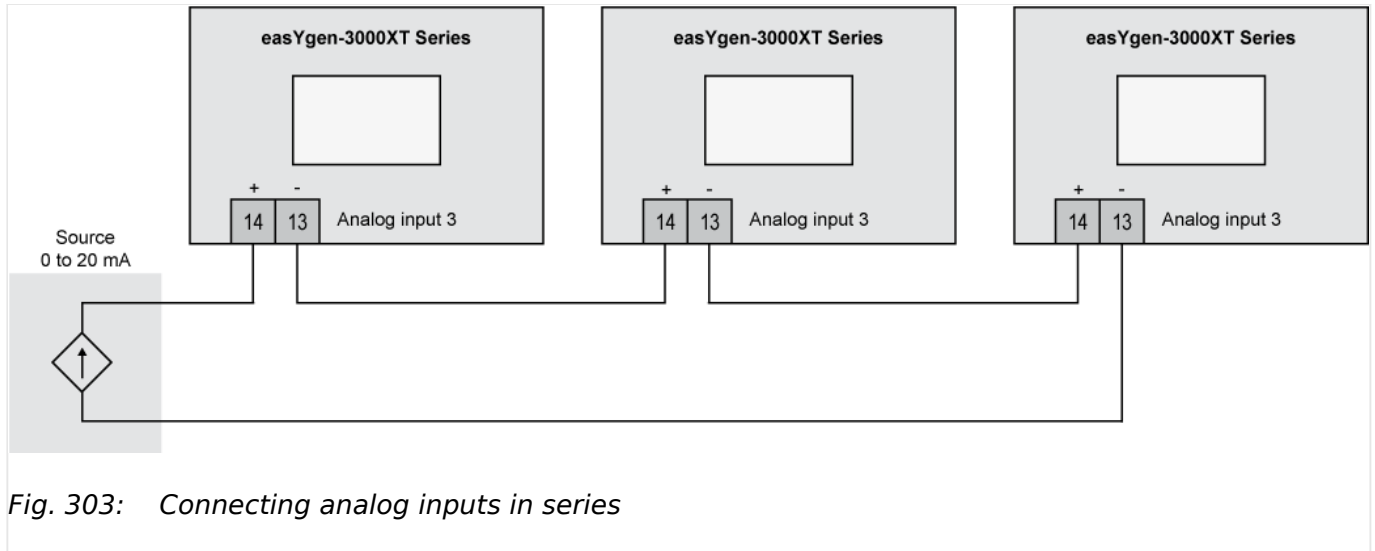

Fig. 303: Connecting analog inputs in series

The graphic above shows the terminal numbers for the analog input 3, but in principle it works for all analog inputs which support a 0/4 to 20 mA signal.

6.3.11 Setup Expansion Modules at CAN 2

General notes

The easYgen is supporting several expansion modules for external analog and digital terminals. It is possible to connect up to four Woodward IKDs (or two IKD-IN-16 and two IKD-OUT-16) for digital inputs and outputs and some third party devices e.g. from Phoenix or WAGO for analog and digital inputs and outputs. Also a combination of the devices listed is possible.

Configuring easYgen for expansion modules is split in two parts:

- One part is located at the external analog/digital inputs/outputs pages and defines how many inputs/outputs are used and the scaling of the analog types. Refer to chapters [4.4.2.4 Analog Inputs](#) for reference.
- The other part is located at the CAN2 interface pages and defines the Node IDs and the types of external devices. Refer to chapter [4.7.4.2.1 Expansion Modules at CANopen Interface](#) for reference.

Additionally the external device must be configured to the correct baud rate and Node ID. This could be done via DIP switches at Phoenix and WAGO, for the IKD with a Woodward IKD configuration tool.

Supported external modules

Phoenix ...				
Bus coupler	Discrete outputs	Discrete inputs	Analog outputs	Analog inputs
IL CAN BK	IB IL 24 DO 2	IB IL 24 DI 2	IB IL AO 2/SF	IB IL AI 2/SF
	IB IL 24 DO 8	IB IL 24 DI 4		IB IL TEMP 2 UTH
	IB IL 24 DO 16	IB IL 24 DI 8		IB IL TEMP 2 RTD
	IB IL 24 DO 32	IB IL 24 DI 16		
	IB IL 24/230 DOR4/W	IB IL 24 DI 32		



There is a maximum of three Phoenix bus couplers on the CAN bus. There is also a maximum of 16AI 4AO 32DI and 32DO, which must not exceeded in all possible combinations.

WAGO ...	
Field bus coupler for CAN	Interface/Connector
750-337 (MCS)	Terminals/clamps
750-338 (SUB-D)	SUB-D

WAGO Analog Inputs (2 x AI or 4 x AI)				
Type	P/N two channel version	P/N four channel version	"Wire break" detection	TYPE: Settings
(SE = Single ended, Diff = Differential)				
Pt100	750-461	750-460/0001	T >849 °C: Overrun T < -200 °C: Underrun	Pt DIN(R0) Sender type: R0 = 100
Pt 1000	750-461/0003	750-460/0003	T >849 °C: Overrun T < -200 °C: Underrun	Pt DIN(R0) Sender type: R0 = 1000
Ni 100	750-461/0004		T >250 °C: Overrun T < -60 °C: Underrun	Ni DIN(R0) Sender type: R0 = 100
Ni 1000 TK6180	750-461/0005		T >250 °C Overrun T < -60 °C: Underrun	Ni DIN(R0) Sender type: R0 = 100
10-1200	750-461/000-002		no	Linear or table Sender type: 0-1200 Ohm
10-5000 Ohms	750-461/000-007		no	Linear or table Sender type: 0-5000 Ohms
4-20 mA (SE)	750-466	750-455	Underrun	Linear or table Sender type: 4-20 mA
0-20 mA (SE)	750-465	750-453	no	Linear or table Sender type: 0-20 mA
0-20 mA (Diff)	750-452		no	Linear or table Sender type: 0-20 mA
4-20 mA (Diff)	750-454		Underrun	Linear or table Sender type: 4-20 mA
+/-10 V (Diff)	750-456		no	Linear or table Sender type: +/-10 V
0-10 V (SE)	750-467	750-468	no	Linear or table Sender type: 0..10 V
Thermocouple (K, T, J, E, S, L)	750-469xxx (standard format)		Overrun Underrun: (approx. -49.8 °C)	TC Type x Sender type: Thermocouple Notes If adjustable variant (750-469/003-000) is used: use "Wago-I/O-CHECK" to adjust (default Type is "K"). For details refer to ↗

WAGO Analog Inputs (2 x AI or 4 x AI)				
Type	P/N two channel version	P/N four channel version	"Wire break" detection	TYPE: Settings
				"Configurable WAGO devices"
+/- 120 mV	750-469/000-003		no	Linear or table Sender type: Thermocouple

WAGO Analog Inputs (8 x AI)			
Type	P/N eight channel version	"Wire break" detection	TYPE: Settings
RTD	750-451	depends on the configured type	TYPE and Sender type: according to the type configured by "Wago-I/O-CHECK" Use "Wago-I/O-CHECK " to configure the different channels (Default type is PT100). For details refer to "Configurable WAGO devices" .
0/4 - 20 mA	750-496	4-20 mA: Underrun 0-20 mA: no detection	TYPE: Linear or table Sender type: 4-20 mA or 0-20 mA Use "Wago-I/O-CHECK " to configure the different channels (Default type is 4-20 mA). For details refer to "Configurable WAGO devices" .
Thermocouple	750-458	Overrun Underrun (approx. -49.8 °C)	TYPE: depends on the configured type Sender type: depends on the configured type Note: if adjustable variant (750-469/003-000) is used use "Wago-I/O-CHECK " to adjust (Default type is K). For details refer to "Configurable WAGO devices" .

WAGO Analog Outputs (2 x AO or 4 x AO)				
Type	P/N two channel version	P/N four channel version	Comments	Settings
0-20 mA	750-552	750-553		Selected hardware type = mA
0-10 V	750-560, [10 bit (100 mW)] 750-550	750-559		Selected hardware type = "V"

WAGO Digital Inputs/Outputs (2 ... 16 x DI/DO)				
# of DIs	2 x DI	4 x DI	8 X DI	16 X DI
P/N	750-400	750-402	750-430	750-1405
# of DOs	2 x DO	4 x DO	8 X DO	16 X DO
P/N	750-501	750-504	750-530	750-1504



There is a maximum of 16 WAGO analog inputs and up to 4 WAGO analog outputs with up to 32 WAGO digital inputs and 32 WAGO digital outputs or up to four IKDs (or two IKD-IN-16 and two IKD-OUT-16).

For all configurations with WAGO devices at least one WAGO CANopen fieldbus coupler 750-337 is required!

Configurable WAGO devices

If configurable WAGO devices are used, the mode of the terminal must be configured via the PC software »Wago I/O Check«. This configuration cannot be done via easYgen parameters. The easYgen parameters for the corresponding channels must be consistent with the Wago configuration!

RTD device (750-451)

Configure this 8 channel device RTD (750-451) via the »Wago I/O-Check« with the following process image:



The following types are not supported: Ni1000 (high resolution), Ni1000 (TK5000), Pt1000 (EN 60751 high resolution), and 1200 Ohms.

Typ	Expected format
Pt100 (EN 60751)	default
Ni100 (EN 60751)	default
Pt500 (EN 60751)	default
Pt200 (EN 60751)	default
Ni1000 (TK6180, DN 43760)	default
Ni120 (Minco)	default
5000 Ohms	S5-FB250

Thermocouple device (750-458) for voltage measurement

There is no intuitive setting in the easYgen if a channel of the TC device (750-458) is configured for voltage measurement. A special scaling of the easYgen parameters "Sender value at display min.." and "Sender value at display max.." like in the table below is required.

WAGO device Voltage range	Configure the according easYgen parameter	
	"Sender value at display min."	"Sender value at display max."
+/- 30 mV	-614.4	614.4
+/- 60 mV	-307.2	307.2
+/- 120 mV	-153.6	153.6

Combinations of modules

All combinations of external terminals up to the maximum of 16AI, 4AO, 32DI, and 32DO are possible.

Selection is done by parameter »Select external terminals « 15320.

There is a maximum of three bus couplers on the CAN bus for PHOENIX modules but (for the moment) only one bus coupler on the CAN bus for WAGO modules.

So WAGO devices must use one and the same CAN address only.

The following table shows the possible configuration combination of the "Type" settings (parameter 5851) and the "Sender type" setting (parameter 5856) for Phoenix devices.

Parameter Type	Sender Type	0 - 10V	±10V	0 - 20mA	±20mA	4 - 20mA	0 - 400 Ohm	0 - 4000 Ohm	Thermocouple	R0=100	R0=10	R0=20	R0=30	R0=50	R0=120	R0=150	R0=200	R0=240	R0=300	R0=400	R0=500	R0=1000	R0=1500	R0=2000	R0=3000
	OFF																								
Linear		X	X	X	X	X	X	X	X																
Table A		X	X	X	X	X	X	X	X																
Table B		X	X	X	X	X	X	X	X																
Thermo couple type K									X																
Thermo couple type J									X																
Thermo couple type E									X																
Thermo couple type R									X																
Thermo couple type S									X																
Thermo couple type T									X																
Thermo couple type B									X																
Thermo couple type N									X																
Thermo couple type U									X																
Thermo couple type L									X																
Thermo couple type C									X																
Thermo couple type W									X																
Thermo couple type HK									X																
Pt DIN(R0)										X	X	X	X	X	X	X	X	X	X	X	X	X	X	X	X
Pt SAMA(R0)										X	X	X	X	X	X	X	X	X	X	X	X	X	X	X	X
Ni DIN(R0)										X	X	X	X	X	X	X	X	X	X	X	X	X	X	X	X
Ni SAMA(R0)										X	X	X	X	X	X	X	X	X	X	X	X	X	X	X	X
Cu10																									
Cu50																									
Cu53																									
Ni 1000(Landis)																									
Ni 500(Viessm.)																									
KTY 81-110																									
KTY 84																									

Don't care

NOT ALLOWED

RIGHT CONFIGURATION

Fig. 304: Supported Phoenix sender types

If *Thermocouple* is configured together with "Table A", "Table B", or "Linear" the input works with a range from -15 mV to 85mV. In this case the values for parameters 2Sender value at display min./"Sender value at display max." must be entered in [mV] (e.g.: min: 0.00, max: 85.00).

Configuration process help

The following flow charts step-by-step guide you through the configuration of external CANopen devices.

For applications with IKD-IN-16 or IKD-OUT-16 use settings with the prefix "IKD" too. For more details refer to "4.7.4.2.1.2 IKD-IN-16, IKD-OUT-16 specifics".



Configuration is the same for Phoenix/WAGO

The flow charts below use "P..." for Phoenix external interfaces but it works similar with "W..." for WAGO devices.

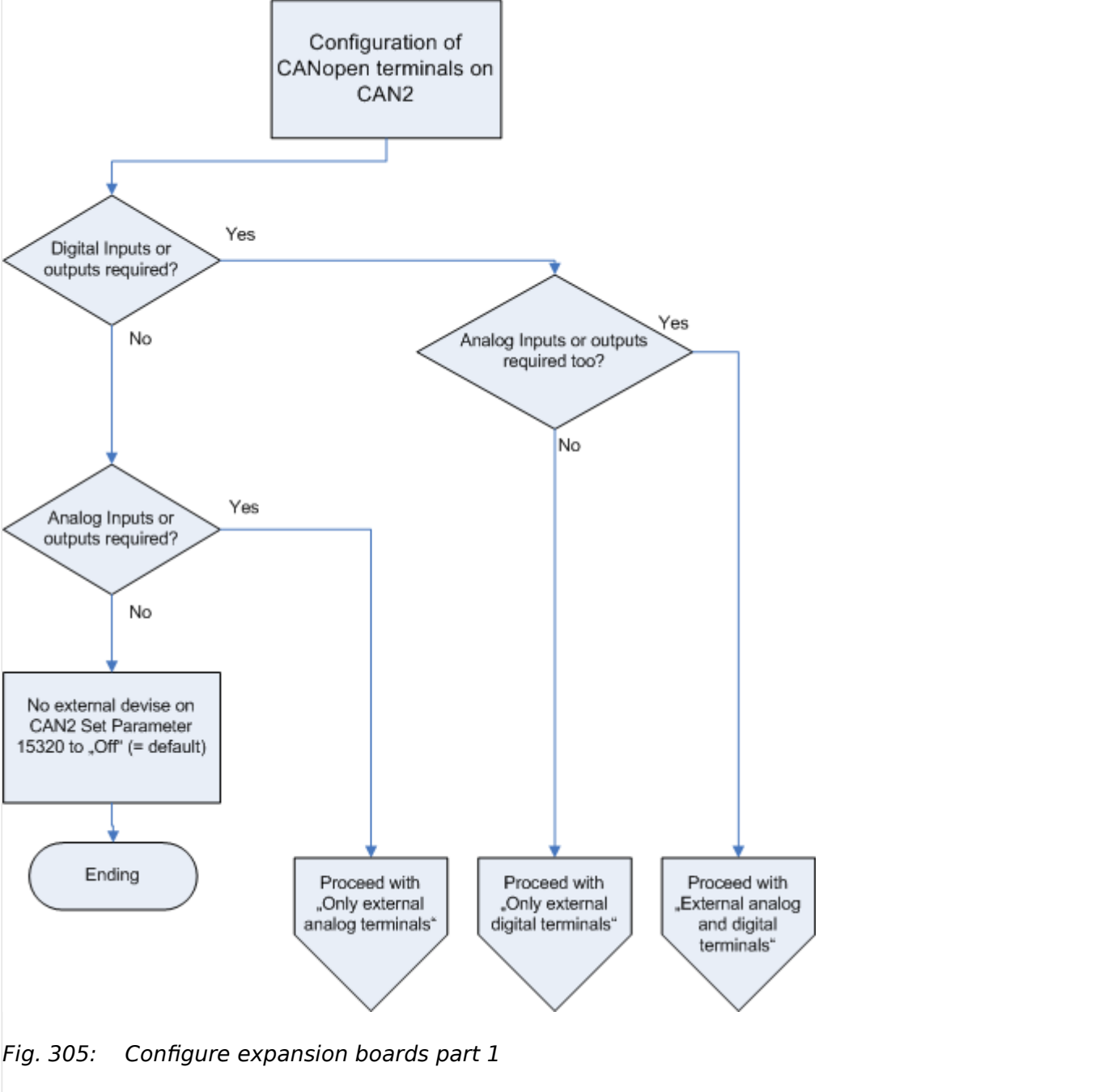

Fig. 305: Configure expansion boards part 1

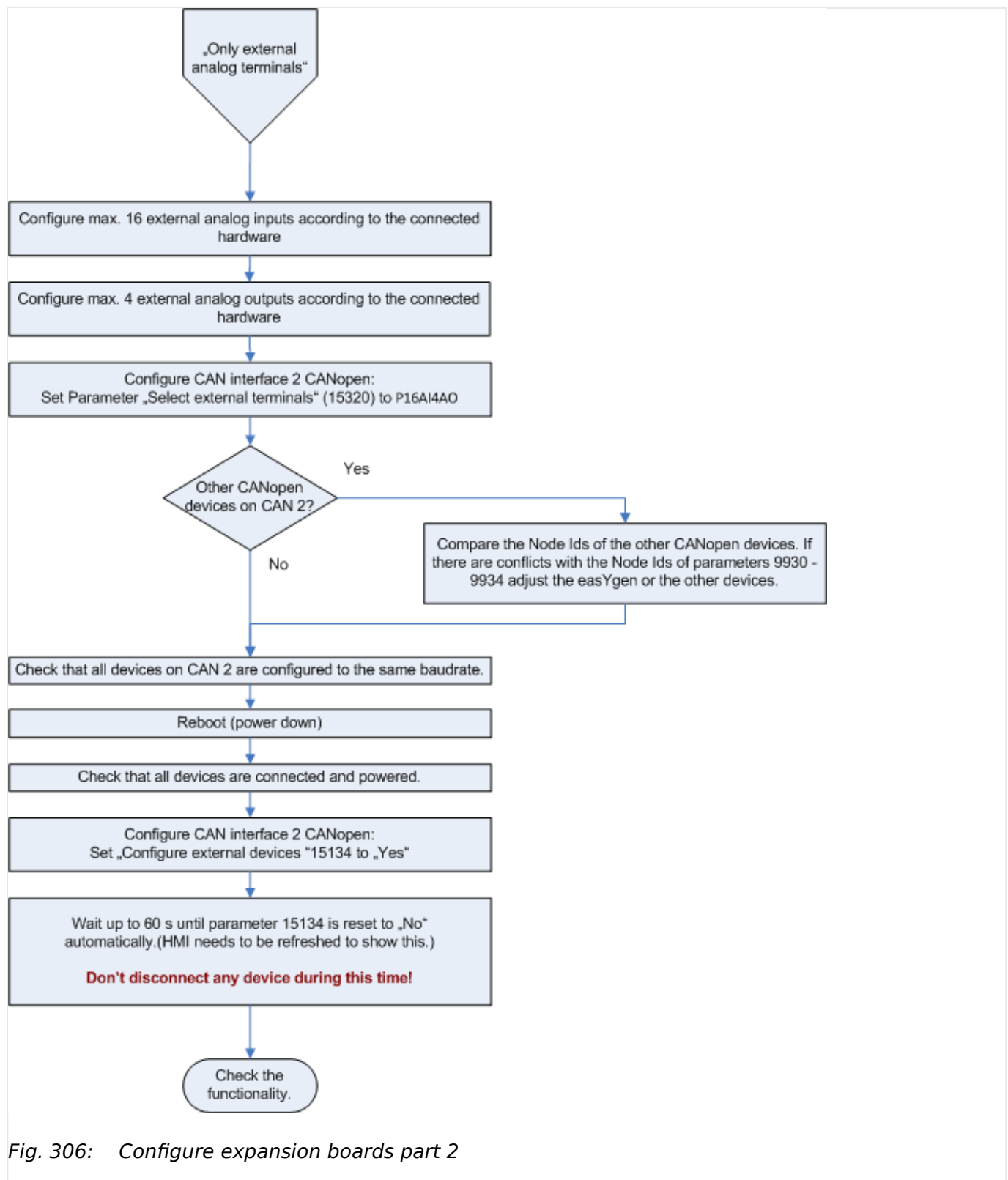

Fig. 306: Configure expansion boards part 2

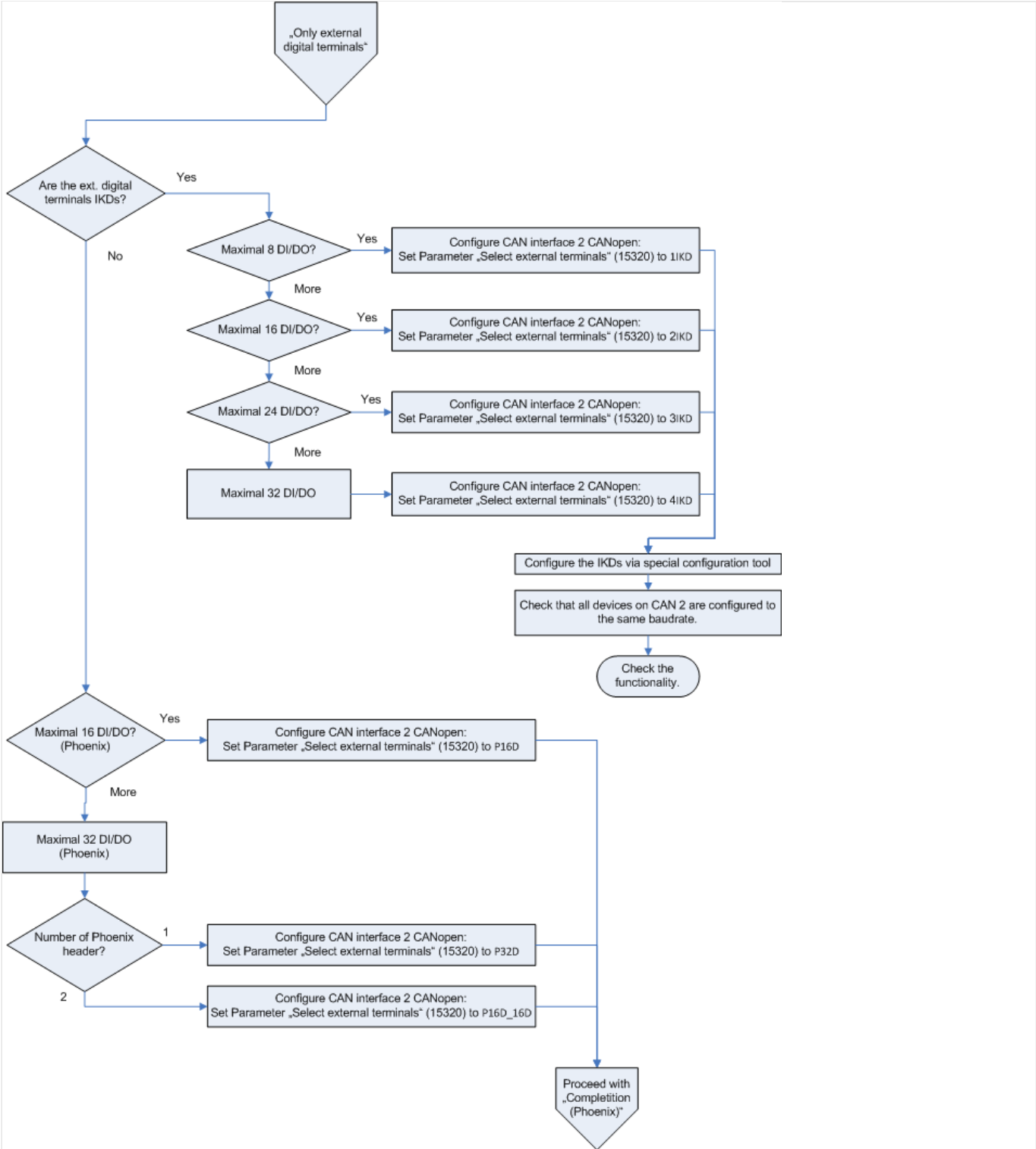

Fig. 307: Configure expansion boards part 3

6 Application Field

6.3.11 Setup Expansion Modules at CAN 2

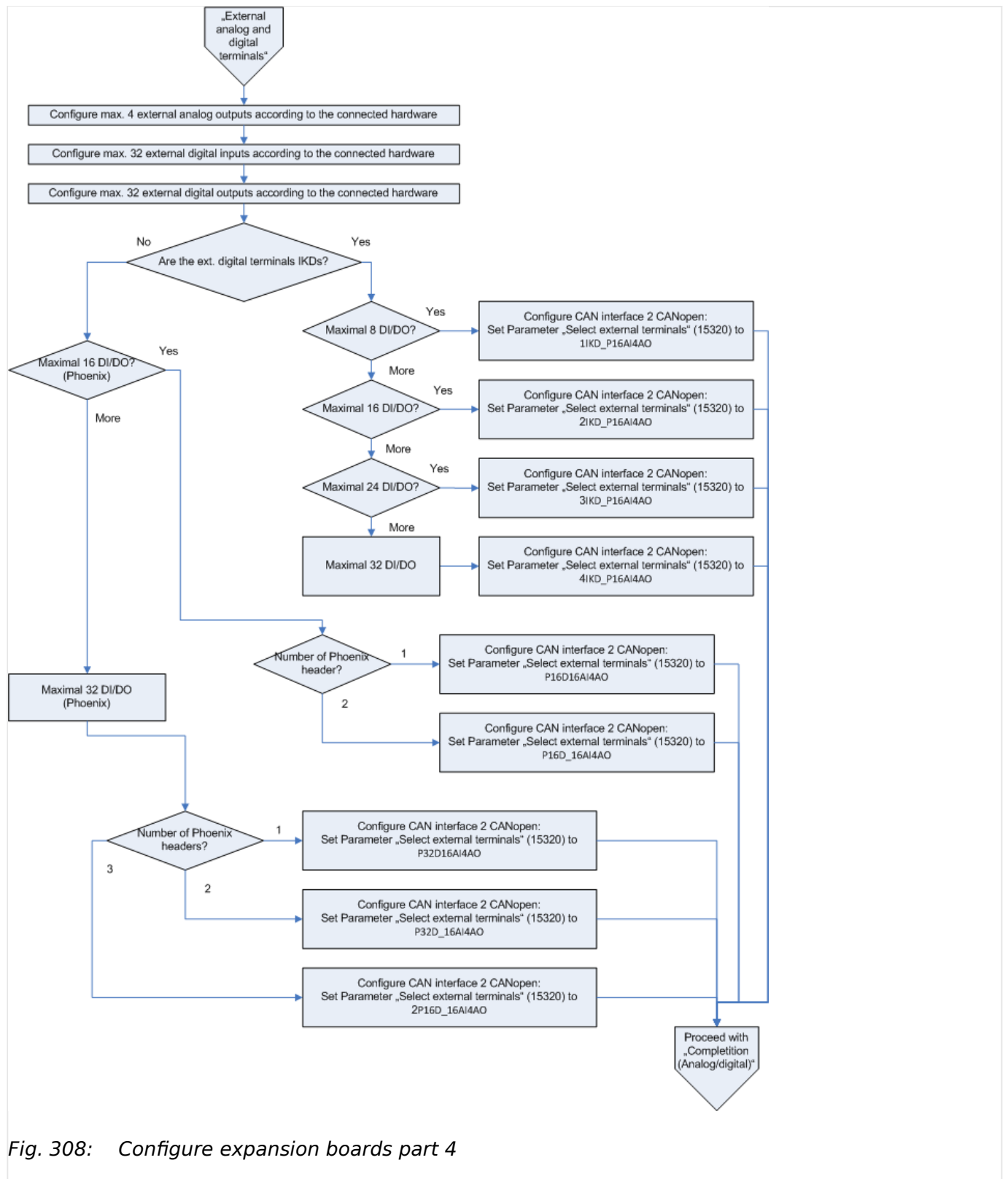

Fig. 308: Configure expansion boards part 4

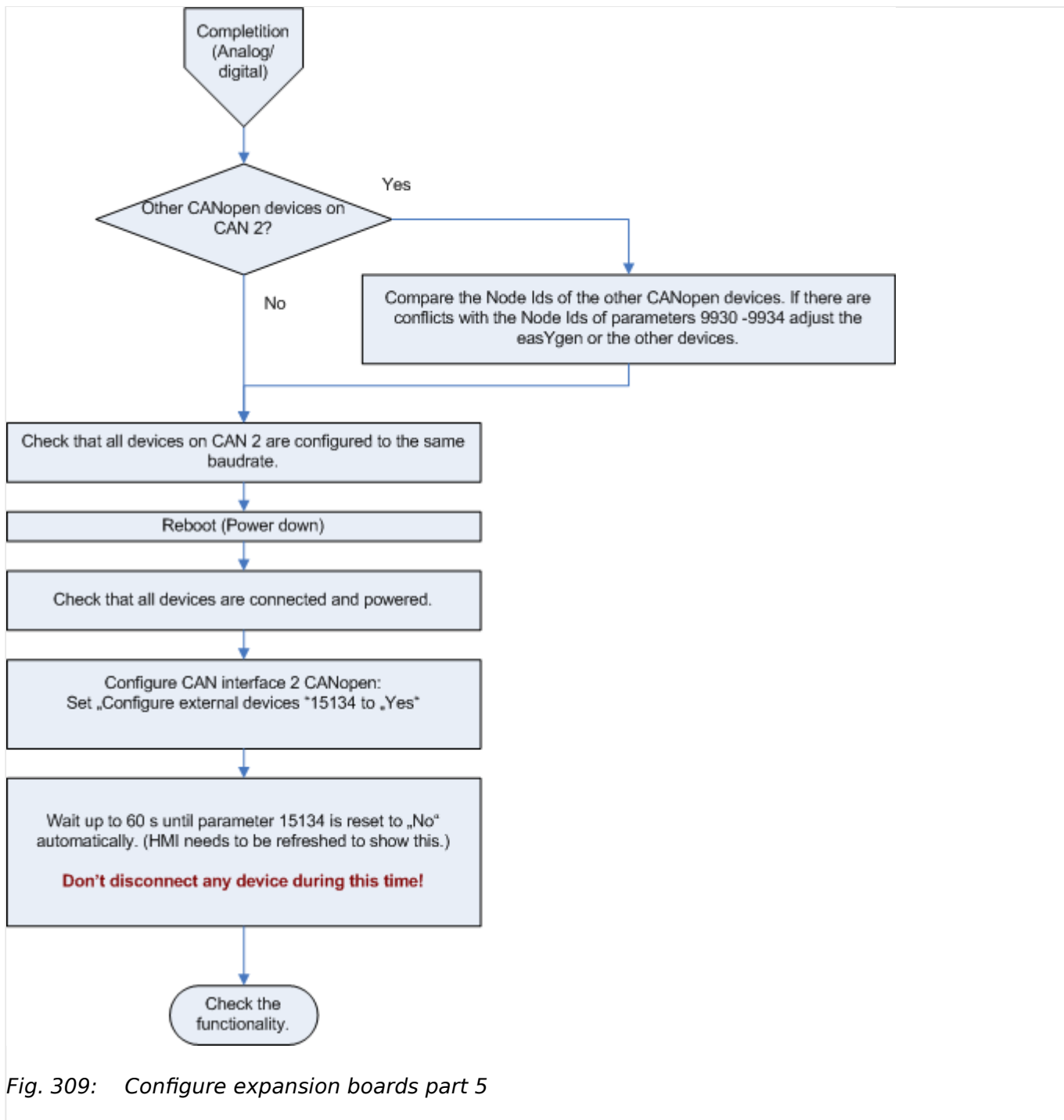

Fig. 309: Configure expansion boards part 5

6.3.12 Phase Angle Compensation

WARNING!



Check parameters!

Erroneous synchronization settings can destroy the generator with destructive power!

Ensure the parameters are configured correctly! Incorrect wiring of the system cannot be compensated for with this parameter.

General notes

This feature allows the easYgen to adapt the phase angle measurement system according to the transformer type. The phase angle of the "generator to busbar" and the "busbar to mains" measurement can be compensated. The phase angle compensation is activated with the parameters "Phase angle compensation GCB" (parameter [↩ 8825](#)) and "Phase angle compensation MCB"/>" (parameter [↩ 8841](#)).

The controller provides an adjustment for a phase angle deviation in a range of +/-180.0°. The range can be configured with the parameters "Phase angle GCB" (parameter [↩ 8824](#)) and "Phase angle MCB" (parameter [↩ 8842](#)). This parameters compensate the phase angle deviation, which can be caused by transformers (i.e. a delta to wye transformer) located within the electrical system.

Example - "Phase angle compensation GCB"

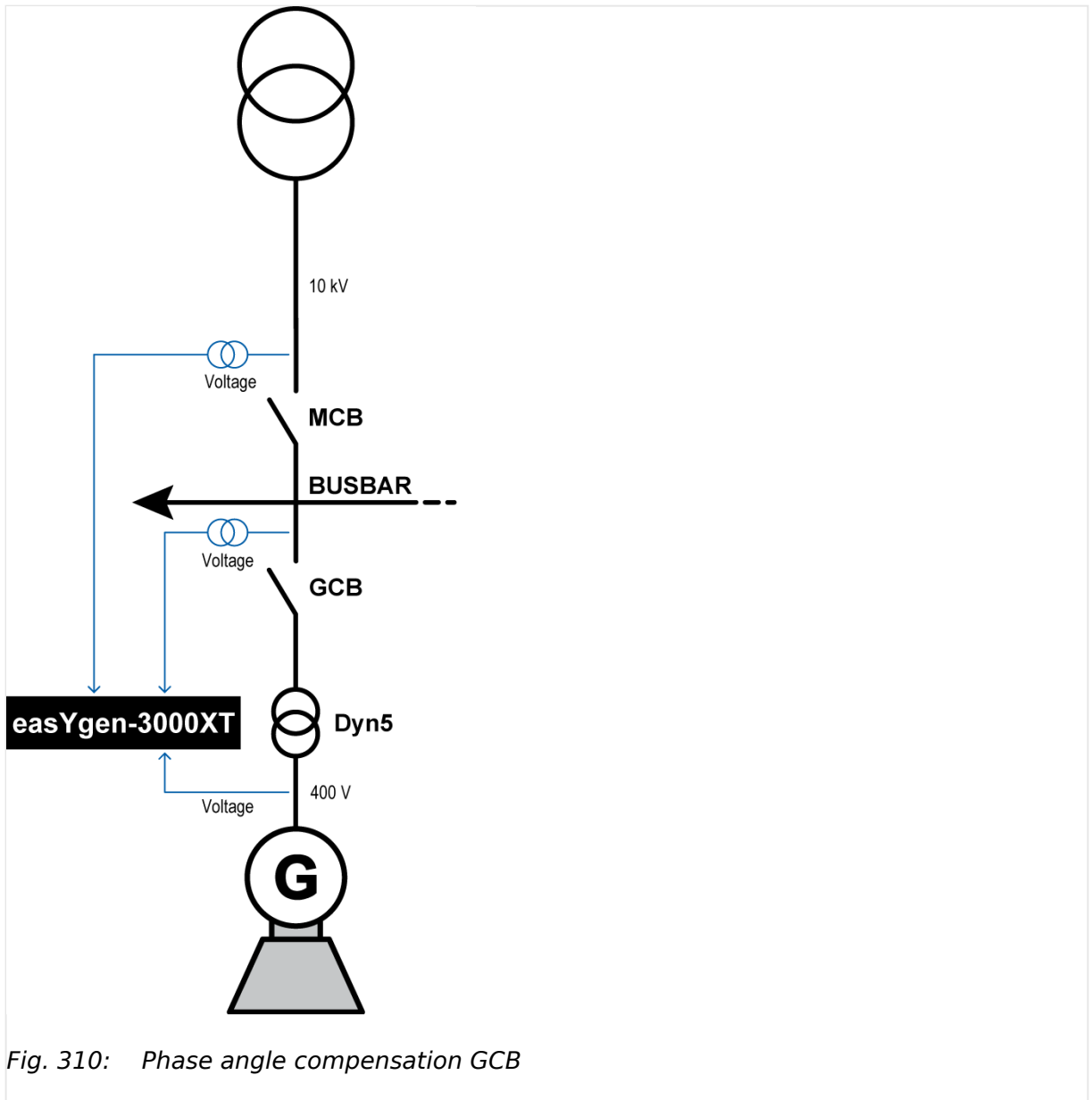



Fig. 310: Phase angle compensation GCB

The easYgen generator voltage is connected to the low voltage side of a transformer with the vector group **Dyn5**. The easYgen busbar voltage is connected to the high voltage side. Because of the transformer, the phase angles between generator and busbar differs due the closed GCB. The synchronization function of the easYgen can be compensated by a configurable phase angle deviation.

Using vector group 5 (Dyn5) implies: $\alpha = 5 \times 30^\circ = 150^\circ$. Since $150^\circ < 180^\circ$ and the easYgen busbar measurement is connected to the high voltage side, this results into " α " to be used as phase difference. Configure parameter "Phase angle GCB" (parameter ) 8824) to "150°" to compensate the phase difference between generator/busbar.

Example - phase angle compensation MCB

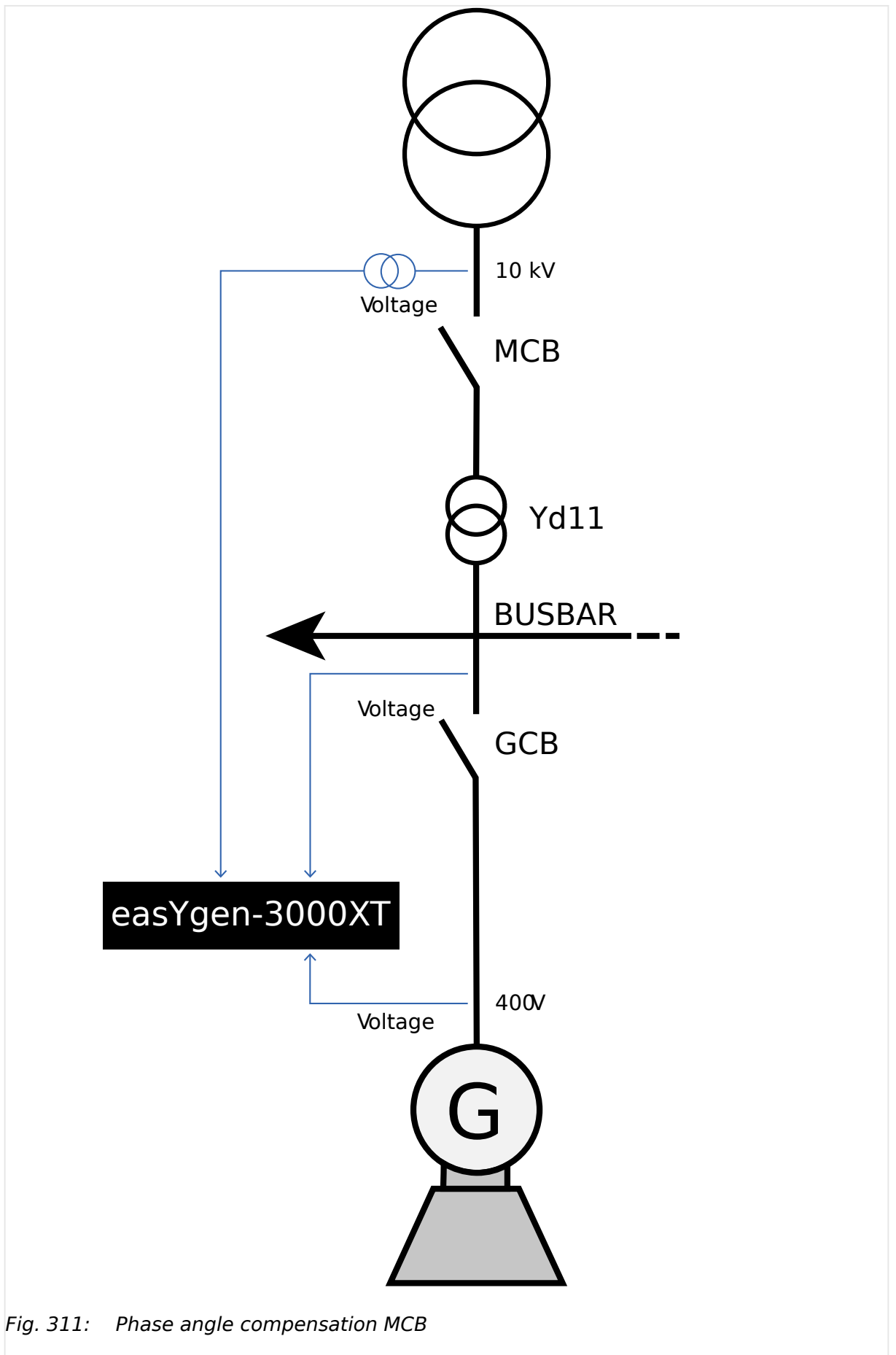

Fig. 311: Phase angle compensation MCB

The easYgen mains voltage is connected to the high voltage side of a transformer with the vector group **Yd11**. The easYgen busbar voltage is connected to the low voltage side. Because of the transformer, the phase angles between mains and busbar differs due the closed MCB. The synchronization function of the easYgen can be compensated by a configurable phase angle deviation.

Using vector group 11 (Yd11) implies: $\alpha = 11 \times 30^\circ = 330^\circ$. Since $330^\circ > 180^\circ$ and the easYgen mains measurement is connected to the high voltage side, this results into $-360^\circ - \alpha$ to be used as phase difference. Configure parameter "Phase angle MCB" (parameter [↔ 8842](#)) to -30° to compensate the phase difference between mains/ busbar.

6.3.13 Start/Stop Logic Mode "Off"

General notes

The start/stop sequence in the easYgen is completely disabled. This function is needed in applications where the control of the start/stop logic is completely done by an external device (e.g. PLC).



The LogicsManager "Release eng.mon." (parameter [↔ 12999](#)) has a special function, if the "Start/Stop mode logic" (parameter [↔ 3321](#)) is configured to "Off". When the LogicsManager becomes TRUE, the delayed monitoring function alarms are triggered, which are delayed by the engine speed. If they become FALSE all engine speed related monitoring functions are switched off. The LogicsManager "Start req. in AUTO" (parameter [↔ 12120](#)) gets a special function if the "Start/Stop mode logic" (parameter [↔ 3321](#)) is configured to "Off". When the LogicsManager becomes TRUE the operational mode begins. With becoming FALSE the operational mode will be left.

To operate the easYgen in this configuration correctly, the following needs to be done:

- The easYgen requires an external feedback, that the drive system will be started. That is the precondition for the easYgen to trigger the delayed monitoring function, which activates, after a delay time, the speed related monitoring functions. (underspeed, underfrequency, undervoltage, etc.)
- The easYgen requires an external feedback, that the drive system will be stopped. That is the precondition for the easYgen to deactivate the speed related monitoring functions. This avoids upcoming alarms due the drive system is stopped.
- The easYgen must be directed to switch into the active operational mode or to exit this operational mode. The operational mode proceeds with the actions according to the configured application and transition modes.

Example

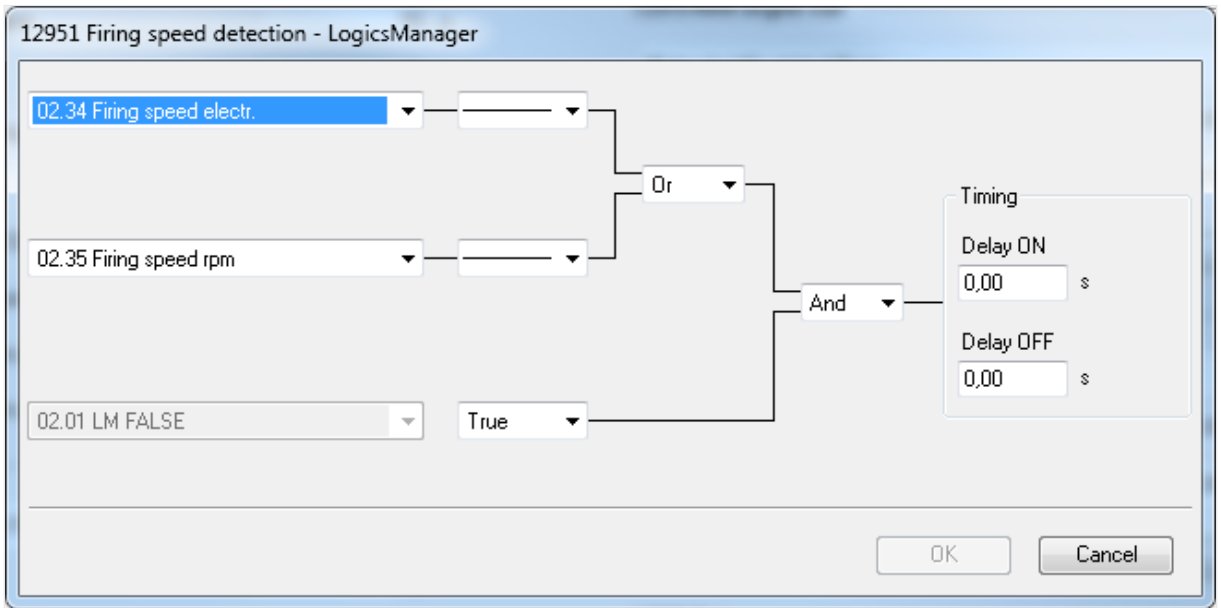

Fig. 312: LogicsManager function "Firing speed detection"

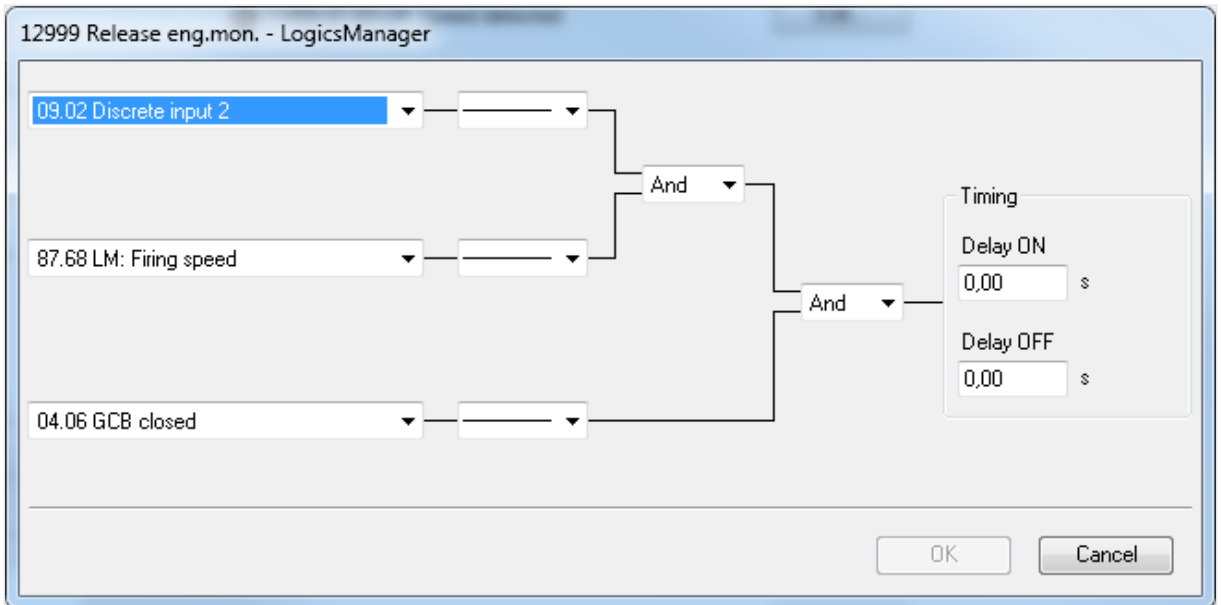

Fig. 313: LogicsManager function "Release eng.mon."

The following section shows a practical example, to explain in detail the described above configuration.

↳ Fig. 313 shows the LogicsManager "Release eng.mon." (parameter ↳ 12999). The LogicsManager could be configured as follows:

- The external start/stop device gives an feedback to the easYgen via discrete input [DI 02] ("09.02 Discrete input 2") that the drive system will be started or already is started.
- Firing speed ("87.68 LM: Firing speed") must be reached.

- Additionally the reply GCB closed ("04.06 GCB closed") must be true to get the result true.

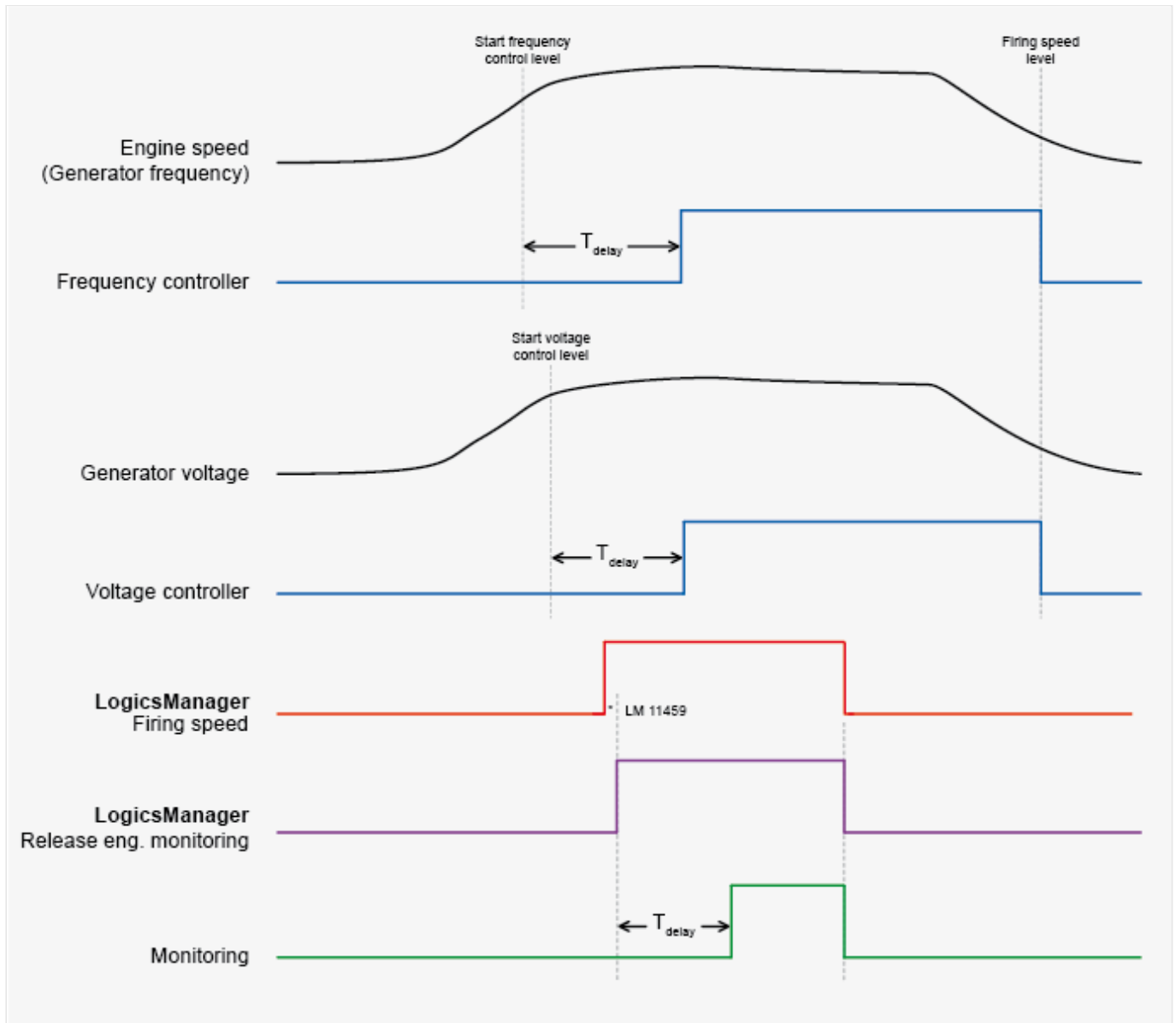

Fig. 314: Start/Stop sequence - LogicsManager "Firing speed detection"

The drawing above shows the following:

- The frequency controller is triggered, if the engine speed (generator frequency) reaches the "Start frequency control level" (parameter [↩ 5516](#)) and after the expired "Start frequency control delay" (parameter [↩ 5517](#)) time. The frequency controller is switched off, if the engine speed (generator frequency) falls below the "Release eng.mon." (parameter [↩ 12999](#)) level.
- The voltage controller is triggered, if the generator reaches the "Start value" (parameter [↩ 5616](#)) and after the expired "Start delay" (parameter [↩ 5617](#)) time. The voltage controller is switched off, if the engine speed (generator frequency) falls below the "Release engine monitoring" (parameter [↩ 12999](#)) level.
- The delayed monitoring function is triggered when LogicsManager "Release eng.mon." (parameter [↩ 12999](#)) becomes TRUE and after the "Engine monitoring

delay time" (parameter [↩➤ 3315](#)). The delayed monitoring function is switched off when LogicsManager "Release eng.mon." (parameter [↩➤ 12999](#)) becomes FALSE.

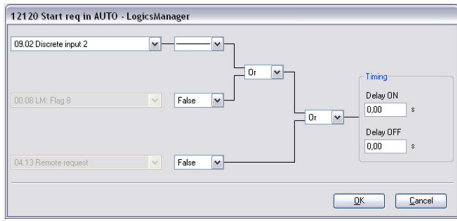

Fig. 315: LogicsManager function Start req. in AUTO

To activate the operational mode in the easYgen, discrete input [DI 02] ("09.02 Discrete input 2") is used in the LogicsManager "Start req. in AUTO" (parameter [↩➤ 12120](#)) .

With removing the start request in AUTOMATIC the operational mode will be left.

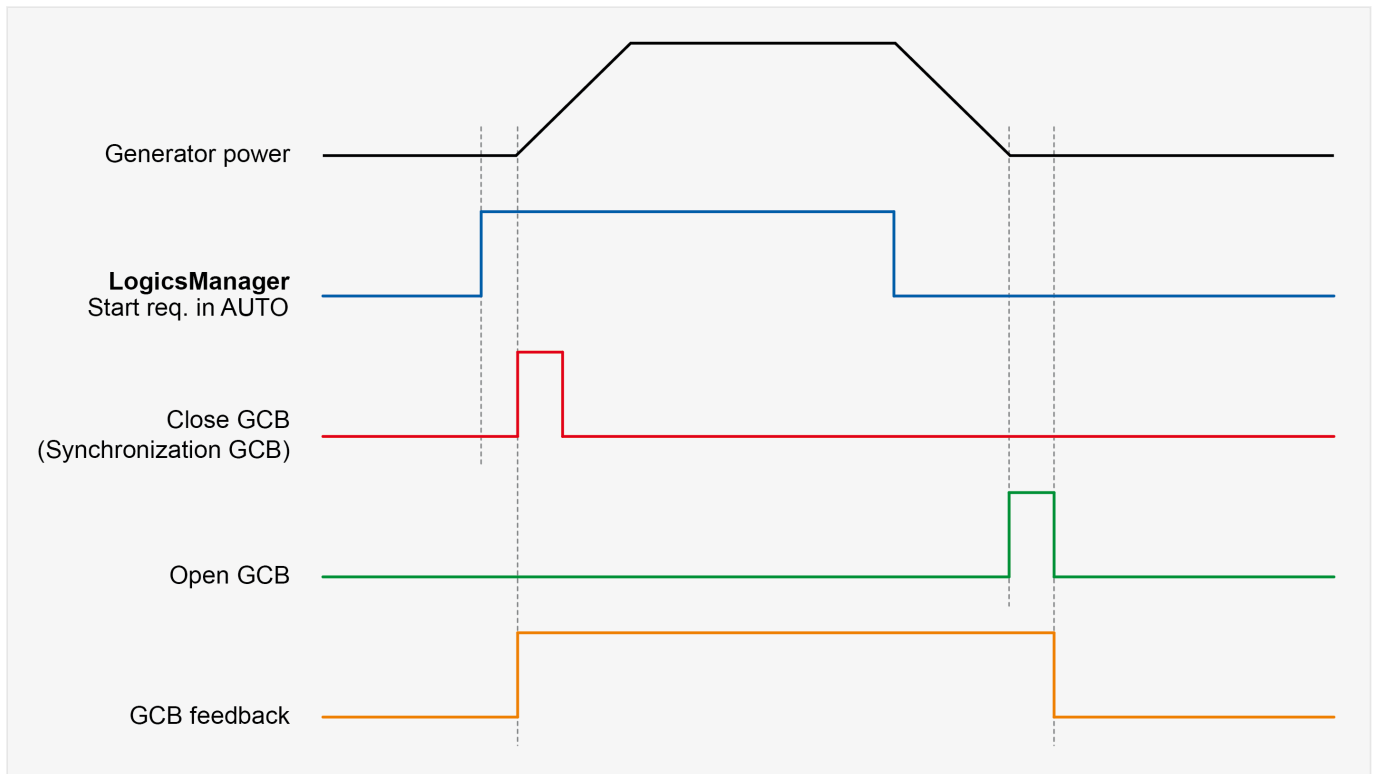

Fig. 316: Start/Stop sequence - LogicsManager Start req. in AUTO

[↩➤](#) Fig. 316 shows the following:

- The closing (synchronization) of the GCB is triggered when LogicsManager Start req. in AUTO (parameter [↩➤ 12120](#)) becomes TRUE.
- The opening (including power down ramping) of the GCB is triggered when LogicsManager Start req. in AUTO (parameter [↩➤ 12120](#)) becomes FALSE.

6.3.14 Ripple Control Receiver

General notes

Decentralized energy producers can be obliged by power supply companies to equip plants with a technical and operational provision for remote-controlled reduction of the feed-in power to stabilize mains. Ripple control is one form of power limitation and is used in many countries around the world.

Functionality

The energy supply company provides a signal to the ripple control receiver to reduce the feed-in power of the generating plant. The ripple control receiver switches four relay contacts according to the required energy power level. This relay contacts correspond for example to the following energy power levels:

- 100% (full feed-in) - Step 1
- 60% - Step 2
- 30% - Step 3
- 0% (no feed-in) - Step 4

The respective contact is closed for the duration of the reduction.

The reduction of the feed-in power must be established within a certain time frame (depending on national regulations).

Derating of power

The power reduction is realized by using the LogicsManager "Free derating" (parameter [15146](#)). This function is using an analog signal. For this reason the relay outputs of the ripple control receiver must be converted into a corresponding analog signal. We recommend a resistor array like shown in [Fig. 317](#) to convert the relay outputs into a analog signal (0 to 500 Ohms).

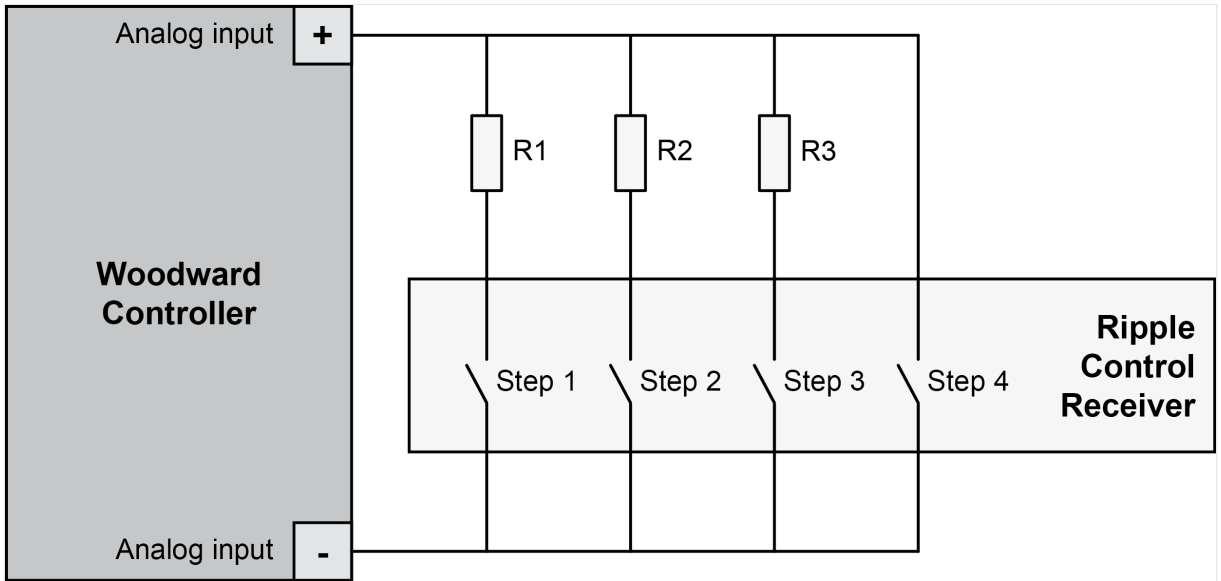

Fig. 317: Ripple control receiver wiring

- R1 = 500 Ohms (or 560 parallel 4.7 k)
- R2 = 300 Ohms (or 330 parallel 3.3 k)
- R3 = 150 Ohms

Max. power [% of rated]	Switched relay ripple control receiver	Corresponding analog value	Derating [% of rated]
100%	Relay - Step 1	500 Ohms	0%
60%	Relay - Step 2	300 Ohms	40%
30%	Relay - Step 3	150 Ohms	70%
0%	Relay - Step 4	0 Ohms	100%

Configuring the analog input for a ripple control receiver

1. ▷ Either on the front panel or using ToolKit navigate to menu [Parameter / Configuration / Configure application / Configure inputs/outputs / Configure analog inputs / Analog input 1].
2. ▷ Configure the parameters listed below.

ID	Parameter	Value	Comment
1000	Type	Linear	A user-defined linear characteristic curve is to be used
1001	User defined min display value	+100.00	A value of 100 is displayed at the minimum of the input range
1002	User defined max display value	+0.00	A value of 0 is displayed at the maximum of the input range

ID	Parameter	Value	Comment
1039	Sender value at display min.	0.000	The sender value at minimum display is 0 Ohms
1040	Sender value at display max.	500.000	The sender value at maximum display is 500 Ohms
1020	Sender type	0 - 2000 Ohm	A 0 to 2000 Ohms sender is used on the analog input
10113	Filter time constant	3	Filter time depending on the ambient conditions
3632	Bargraph minimum	+0.00	The start value for the bargraph display of the analog input is 0
3633	Bargraph maximum	+100.00	The end value for the bargraph display of the analog input is 100 and indicates the derating

3. ▷ Configure the following parameters using ToolKit. They facilitate a more detailed display of the analog value.

ID	Parameter	Value	Comment
1025	Description	Derating	Analog input [AI 01] is labeled with "Derating" on the display
1034	Unit	%	Text "%" is displayed for the unit
1035	Exponent for protocol	0	Value displayed "as is" (without exponent)



Configuring the derating of power

1. ▷ Either on the front panel or using ToolKit navigate to menu [Configure load control / Derating of power].
2. ▷ Configure the parameters listed below.

ID	Parameter	Value	Comment
15149	Direct Derating	On	Only the analog source is used for the derating
15147	AM Derating source	Determined by AnalogManager 81.21 A1 = 06.01 Analog input 1	E.g. »06.01 Analog input 1« can be configured as the analog source which controls the derating function Select "Pass through"
15142	J1939 derating	Off	The derate command via ECU is ignored

3. ▷

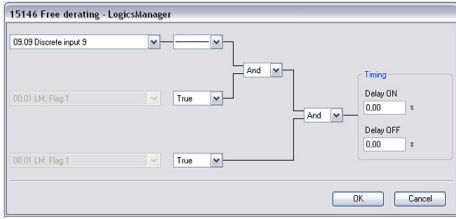

Fig. 318: LogicsManager function "Free derating"

Configure the LogicsManager function "Free derating" as shown in (↳ Fig. 318) to enable derating of power if discrete input [DI 09] is energized.



Please configure "Alarm class" (parameter ↳ 1362) of discrete input [DI 09] to "Control".

Maximal power setpoint

After the unit is configured as described above, the maximal power setpoint looks like shown in ↳ Fig. 319.

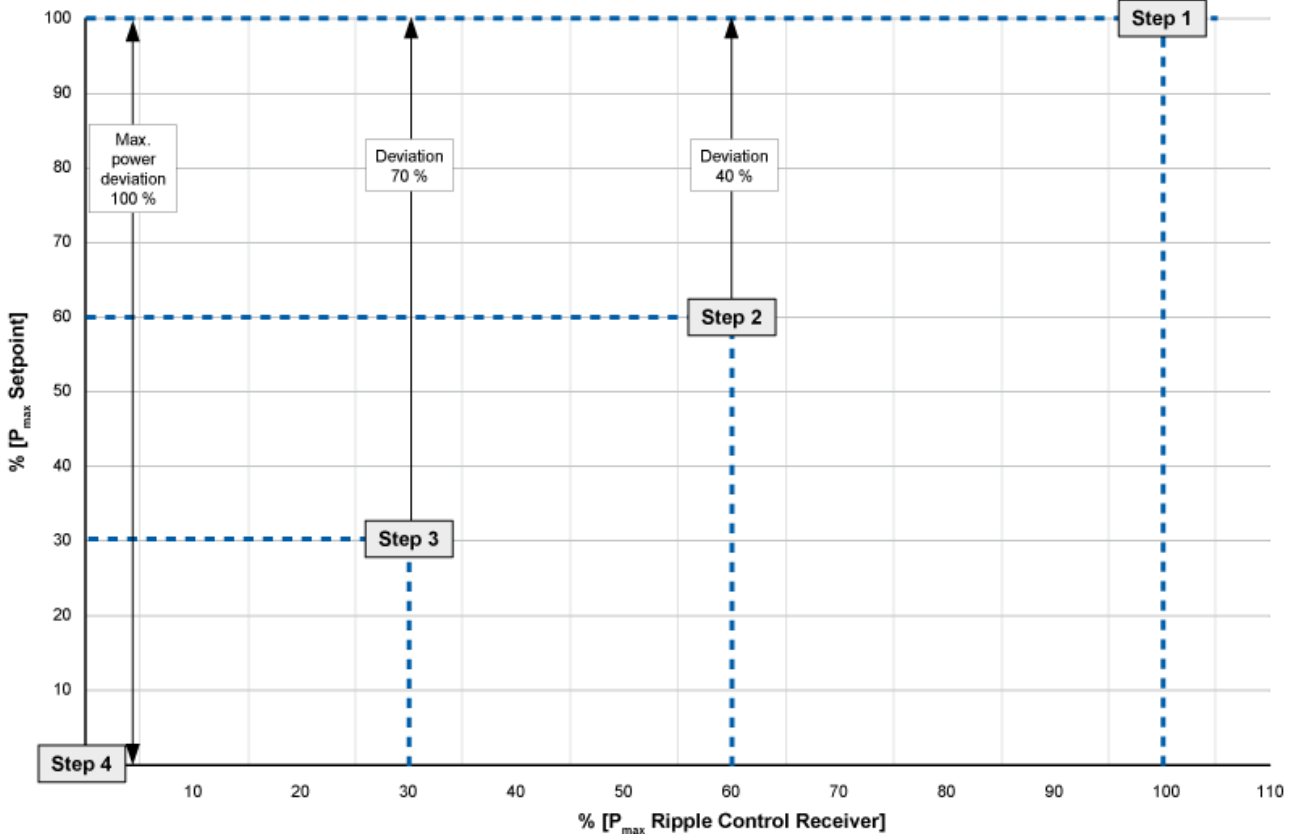

Fig. 319: Maximal power setpoint

6.3.15 Neutral Interlocking

General Notes



This function is not usable in the application mode "GCB/GC" **ATB**.

The Neutral Interlocking function controls in multiple-gen applications the Neutral Contactor (NC) of each generator. The contactor bridges the Neutral with the PE. The rule is that only one neutral of the running generators in the same segment are bridged to earth.

The Logic ensures that with changing of generators or a lacking neutral breaker the neutral link is passed over to another active running generator. This requires information exchange between the genset controls. The load share protocol in the easYgen provides the according information.

Application Examples

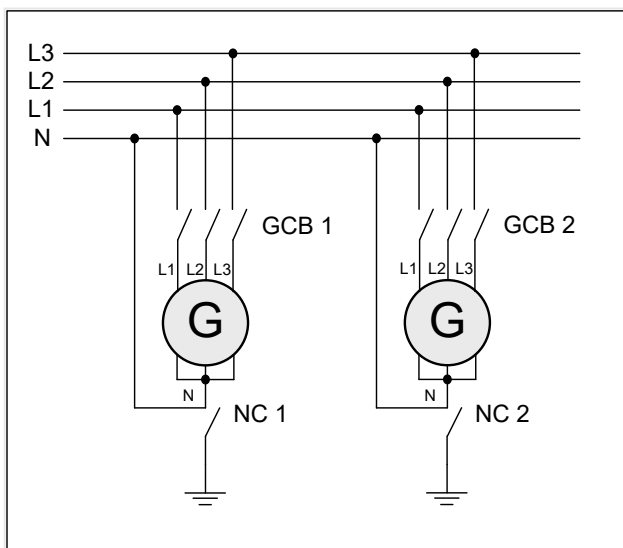

Fig. 320: Wiring neutral Interlocking: GCB 3-pole

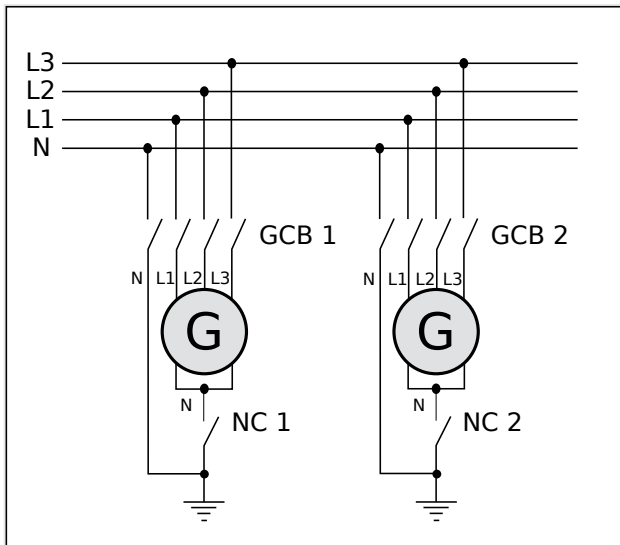

Fig. 321: Wiring neutral Interlocking: GCB 4-pole

Function

Start and operating

The genset control closes principally after each successful start (firing speed reached) the NC. The genset control proceeds with closing the GCB, if the NC has been closed successfully. If the NC closure was not successful the easYgen issues an alarm. The NC and GCB closure procedure is blocked from now on, until the alarm is acknowledged.

When the GCB is closed the genset control begins to figure out, whether the own NC can remain closed or must be opened. This monitoring is done continuously.

As long the GCB is closed, the NC remains closed or is closed, if:

- No connection to mains is active

AND

- one of the following is TRUE
 - the own NC is the only closed NC in the same segment

OR

- there is minimum one other NC in the same segment closed but the own generator has a higher neutral interlocking priority

OR

- there is minimum one other NC in the same segment closed which has the same neutral interlocking priority but the own genset control has a lower device number

In all other cases the NC is opened!

Running Generator without closed GCB

As long the engine/generator is running and the GCB is open the NC will be closed or remains closed until the engine/generator is stopped.

Neutral Contactor (NC) Feedback

The discrete input 12 (DI 12) is used as feedback of the Neutral contactor and cannot be configured onto another discrete input. If the input is energized, the neutral contactor is recognized as closed.

Monitoring NC Feedback

The monitoring of the NC feedback is performed always, if the Neutral Interlocking is enabled. The monitor checks, if the feedback behaves according to the NC command. With a configurable delay time the alarm is activated with a general alarm text. Open or closure failure are not differentiated. The issued Alarm text is: "N-cont. reply mism." (Neutral contactor has a reply mismatch).

Event logger and NC Feedback

If the Neutral Interlocking is enabled, following event entries shall take place:

- "Neutral cont. opened" (with +)
- "Neutral cont. closed" (with +)

Priority for Closing NC

The priority for closing GCB is configurable (parameter  1841). This priority is independent from the LDSS priority. The customer can freely decide which generator shall get which priority.



The advantage of this determination is that the application is not fixed with rated power settings. Maybe there are other circumstances which shall determine the neutral interlocking priority.

Two LogicsManager variables give further information:

- "03.39 Close neutral cont."
- 17.09 N-cont. reply mism.

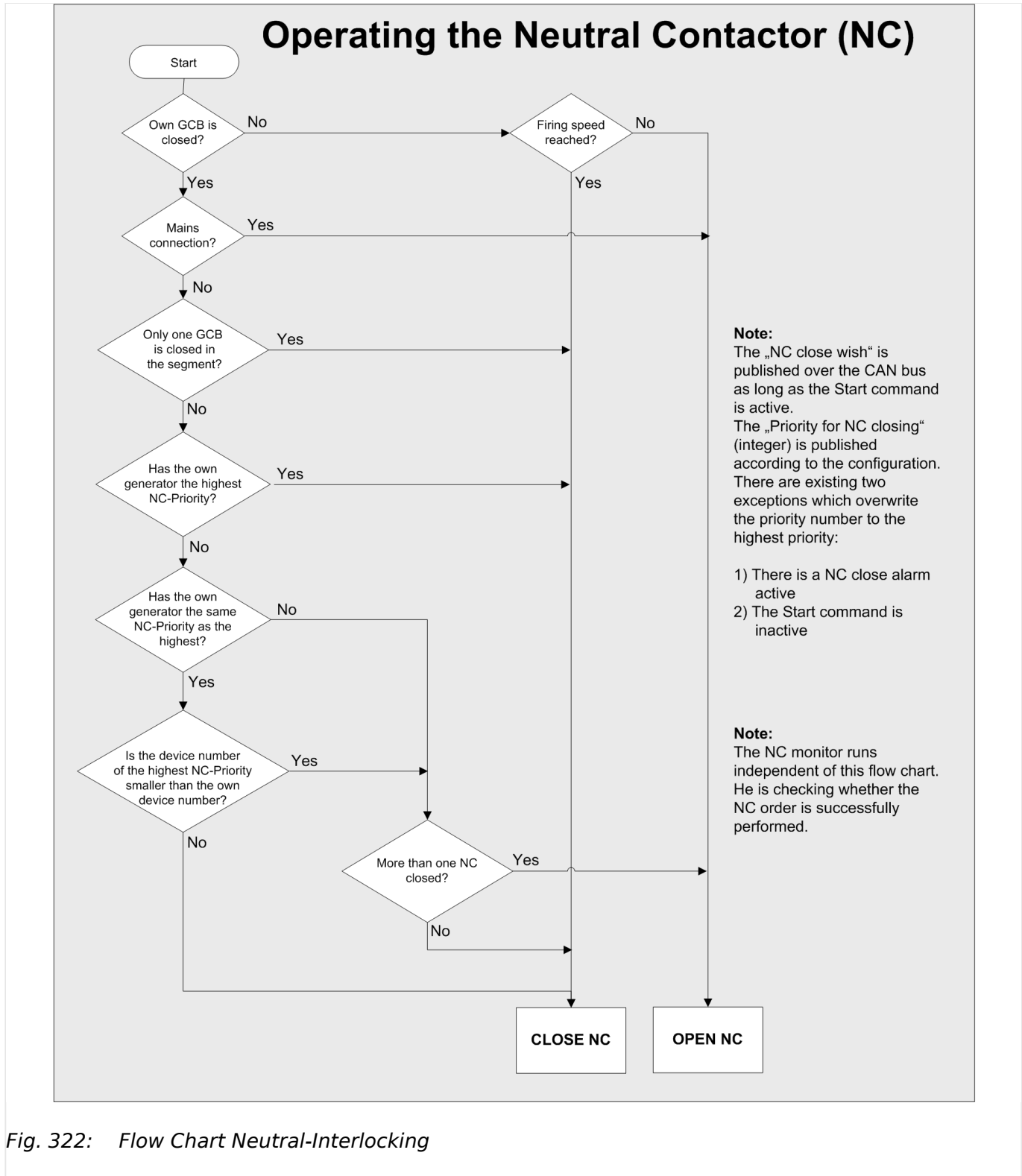

Fig. 322: Flow Chart Neutral-Interlocking

6.3.16 Run-Up Synchronization

The generators are paralleled together by closing their circuit breakers during the engine start sequence. Then after a certain speed is achieved the voltage regulators are enabled and the generators will produce voltage. The run-up synchronization method is used to get several synchronous generators onto load in a very short time. This time is determined by the engine start time and the AVR on-excitation.

Another application for using run-up synchronization is the excitation of power transformers. In some cases the in-rush current of a transformer may be more than one generator can supply when closing the live generator to the dead transformer. Using this run-up synchronization method allows the generator and transformer to build up voltage gradually through the start without the large in-rush.

The run-up synchronization supports also a GCB closure for magnetizing a power transformer under defined circumstances, if the prime mover is not controlled by the device.

General notes

- The run-up synchronization is generally released by configuration.
- The run-up synchronization is supported in dedicated application Modes and breaker transition modes.
- To get the run-up synchronization procedure active the LogicsManager 12937 "Run-up sync." has to be set on TRUE.
- When run-up synchronization is enabled the easYgen evaluates before each start an open connection to mains. For the case the generator would be connected to mains during run-up synchronization the unit would automatically open the connection to mains before start.
- The run-up synchronization requires an rpm speed source (MPU or J1939).
- With enabling the run-up synchronization the command variable "03.24 Excitation enabled" is usable. The activation can be checked in the online diagram.
- The excitation can be simultaneous or individual. The simultaneous excitation can reduce the cross currents between generators in some critical situations.
- After the excitation was enabled and the "Engine monitoring delay time" (Parameter  3315) expired, the easYgen is ready for load. If the easYgen is ready for load, the command variable "04.73 Run-up sync.finished" becomes active.
- The run-up synchronization can be executed in two modes:
 - Mode GCB: With starting the engines the GCB will be closed.
 - Mode GCB/GGB: With starting the engines the GCB and GGB will be closed.



Multiple Genset Run-Up

Run-up synchronization can be interrupted by an "Undelayed close" request!

Woodward strongly recommends to configure all gensets of a run-up synchronization system similar to avoid unexpected run-up synchronization interruptions.

Example applications

The run-up synchronization can be applied in different applications. The following figures show some examples.

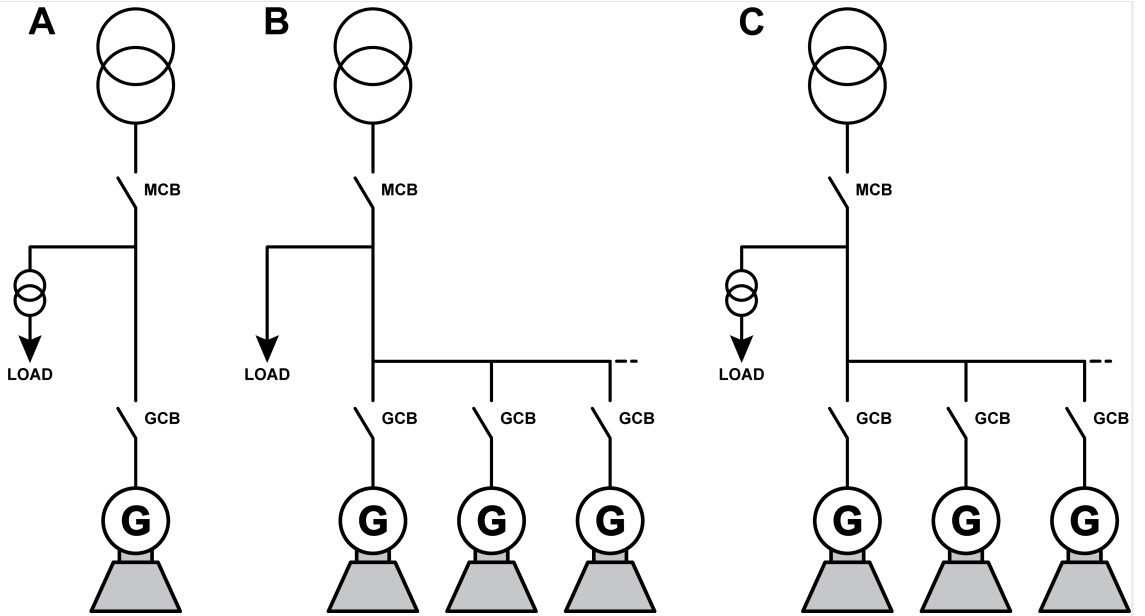

Fig. 323: Run-up synchronization examples

- A Single generator with power transformer without GGB
- B Multiple generators with load on busbar without GGB
- C Multiple generators with large transformer on busbar without GGB

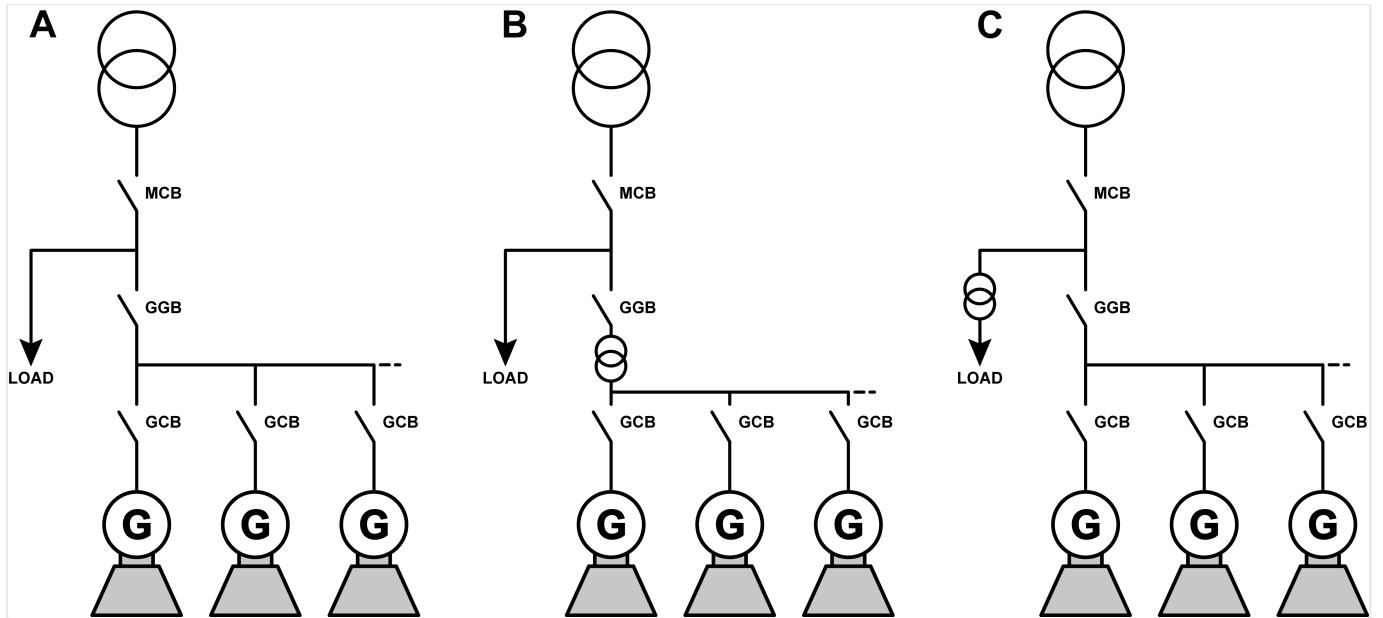

Fig. 324: Run-up synchronization examples

- A Multiple generators with large load on busbar with GGB
- B Multiple generators with common transformer and GGB
- C Multiple generators with large transformer load on busbar and GGB

6.3.16.1 Configuration

Breaker modes

The run-up synchronization can be used in following breaker modes.

- Application mode GCB **A03**
- Application Mode GCB/MCB **A04** (GCB/L-MCB **A08**)
 - Parallel
 - Interchange
 - Closed Transit.
 - Open Transition
- Application mode GCB/GGB **A05** (GCB/L-GGB **A10**)
- Application mode GCB/GGB/MCB **A06** (GCB/L-GGB/L-MCB **A11** and GCB/L-GGBMCB **A12**)
 - Parallel
 - Open Transition
 - Closed Transit.
 - Interchange
- Application mode GCB/LSx **A07**, (GCB/GGB/L-MCB **A09**) and "GCB/GC" **A13**

Preconditions

The following preconditions must be fulfilled to use the run-up synchronization.

- The run-up synchronization is enabled AND
- The MPU input is enabled AND
- The operating mode AUTOMATIC is active AND
- The LogicsManager LogicsManager 12937 "Run-up sync." is "TRUE" AND
- An engine start command is active AND
- The unit recognizes a generator dead busbar situation AND
- No shutdown alarm is present

Interrupt conditions



The run-up synchronization is interrupted by following conditions.

- The run-up synchronization is disabled OR
- The LogicsManager 12937 "Run-up sync." is not TRUE OR
- A shutdown failure (alarm class C, D, E or F) is active OR

- An engine start command is not active OR
- The „Generator Group Breaker is closed” AND the run-up synchronization mode does not allow this

Behavior of the biasing signals

During the run-up synchronization the frequency controller, the voltage controller and the load sharing are disabled. To avoid a reverse power condition shortly after activation of the excitation, the biasing signals of the easYgen will behave with a droop (static) curve.

The droop settings for the frequency f (parameter  5504) and voltage V (parameter  5604) are used for this calculation.

The initial state frequency decreases as active power increases according to this formula:

- Initial State Frequency Deviation = Initial State Frequency*Active Power [%]*Droop f [%]

The initial state voltage decreases as reactive power increases according to this formula:

- Initial State Voltage Deviation = Initial State Voltage*Reactive Power [%]*Droop V [%]

The frequency and voltage biasing is switched on, when the excitation is activated and the following triggered "Engine monitoring delay time" (parameter  3315) has expired.

6.3.16.2 Procedures

6.3.16.2.1 Application Mode GCB

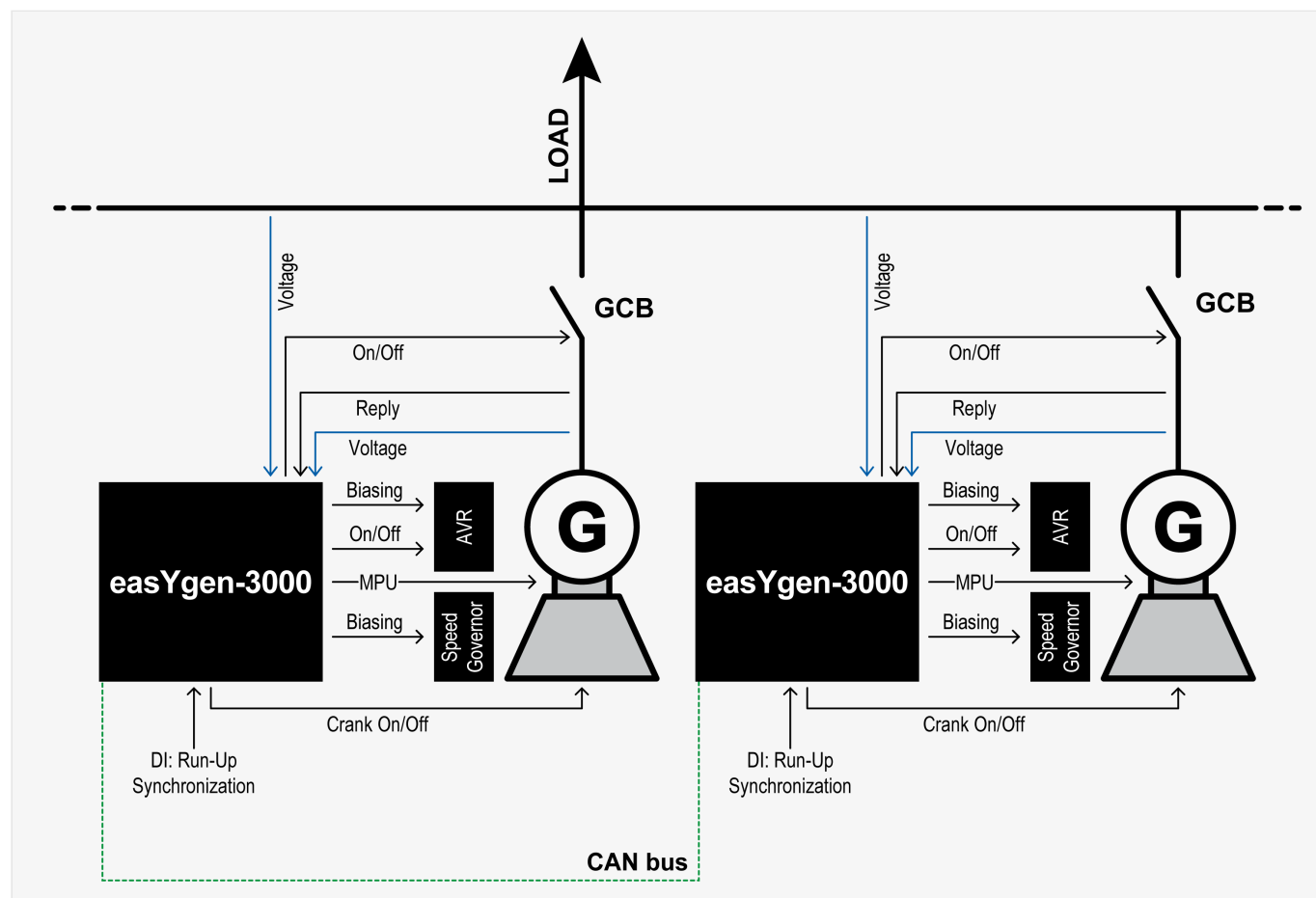

Fig. 325: Application mode GCB

Run-up synchronization GCB

ID	Parameter	Setting range	Proposal
3435	Run-up synchronization Mode	Off / with GCB / with GCB/GGB	with GCB
3436	Minimum speed for close GCB	0 to 4,000 rpm	350 rpm
3437	Speed for excitation start	0 to 4,000 rpm	700 rpm
3438	Time of participation	1 to 180 s	7 s
3442	Simultaneous excitation	Off / On	Off
12937	Run-up sync.	LogicsManager	DI 11

Table 122: Run-up synchronization

Preconditions for run-up synchronization:

- GCB open

- MCB open (no mains connection)
- Engine(s) are stopped
- Run-up synchronization is released (LogicsManager)

With the start command the easYgen sets the solenoid valve, the starter and closes the GCB. The unit displays "Run-up synchronization". If the engine reaches the 700 rpm (speed for excitation start) the easYgen activates the excitation. From now on monitoring delay time is decremented from start value "Engine monitoring delay time" (parameter [↩> 3315](#)) until it is expired; then:

- The underfrequency / overfrequency monitoring is activated
- The undervoltage monitoring is activated
- The pickup/frequency monitoring is activated
- The frequency and voltage controller is activated



Run-up synchronization acting on GCB and GGB is not applicable in this application mode. The run-up synchronization is inhibited.

6.3.16.2.2 Application Mode GCB/GGB

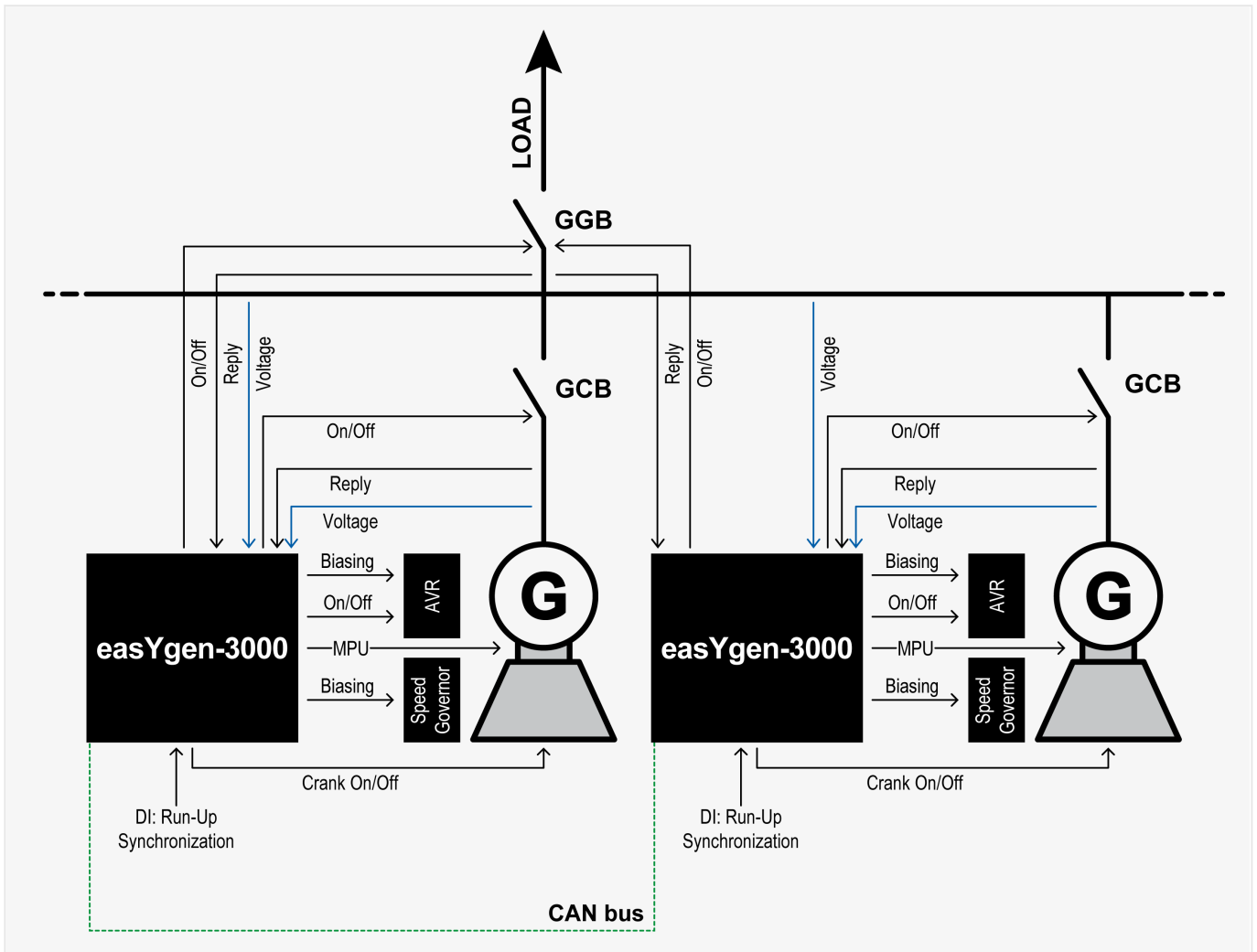

Fig. 326: Application mode GCB/GGB

Run-up synchronization GCB

ID	Parameter	Setting range	Proposal
3435	Run-up synchronization Mode	Off / with GCB / with GCB/GGB	with GCB
3436	Minimum speed for close GCB	0 to 4,000 rpm	350 rpm
3437	Speed for excitation start	0 to 4,000 rpm	700 rpm
3438	Time of participation	1 to 180 s	7 s
3442	Simultaneous excitation	On / Off	Off
12937	Run-up sync.	LogicsManager	DI 11

Table 123: Run-up synchronization

ID	Parameter	Setting range	Proposal
3440	Min. Generator power	0.00 to 327.67 MW	0.10 MW

ID	Parameter	Setting range	Proposal
12936	Bypass min. Pgen.	LogicsManager	—
3441	Voltage monitoring load busbar	On / Off	Off

Table 124: GGB control

Preconditions for run-up synchronization:

- GCB open
- GGB open
- MCB open
- Engine(s) are stopped
- Run-up synchronization is released (LogicsManager)

With the start command the easYgen sets the solenoid valve, the starter and closes the GCB. The unit displays "Run-up synchronization". If the engine reaches the 700 rpm (speed for excitation start) the easYgen activates the excitation. From now on monitoring delay time is decremented from start value "Engine monitoring delay time" (parameter [↪ 3315](#)) until it is expired; then:

- The underfrequency / overfrequency monitoring is activated
- The undervoltage monitoring is activated
- The pickup/frequency monitoring is activated
- The frequency and voltage controller is activated
- The closing of the GGB will be executed, if enough generator power is available on generator busbar

Run-up synchronization GCB and GGB

ID	Parameter	Setting range	Proposal
3435	Run-up synchronization Mode	Off / with GCB / with GCB/GGB	with GCB/GGB

Table 125: Run-up synchronization

Preconditions for run-up synchronization:

- GCB open
- GGB open
- MCB open
- Engine(s) are stopped
- Run-up synchronization is released (LogicsManager)

With the start command the easYgen sets the solenoid valve, the starter and closes the GCB and GGB. The unit displays "Run-up synchronization". If the engine reaches the 700

rpm (speed for excitation start) the easYgen activates the excitation. From now on monitoring delay time is decremented from start value "Engine monitoring delay time" (parameter [3315](#)) until it is expired; then:

- The underfrequency / overfrequency monitoring is activated
- The undervoltage monitoring is activated
- The pickup/frequency monitoring is activated
- The frequency and voltage controller is activated

6.3.16.2.3 Application Mode GCB/MCB

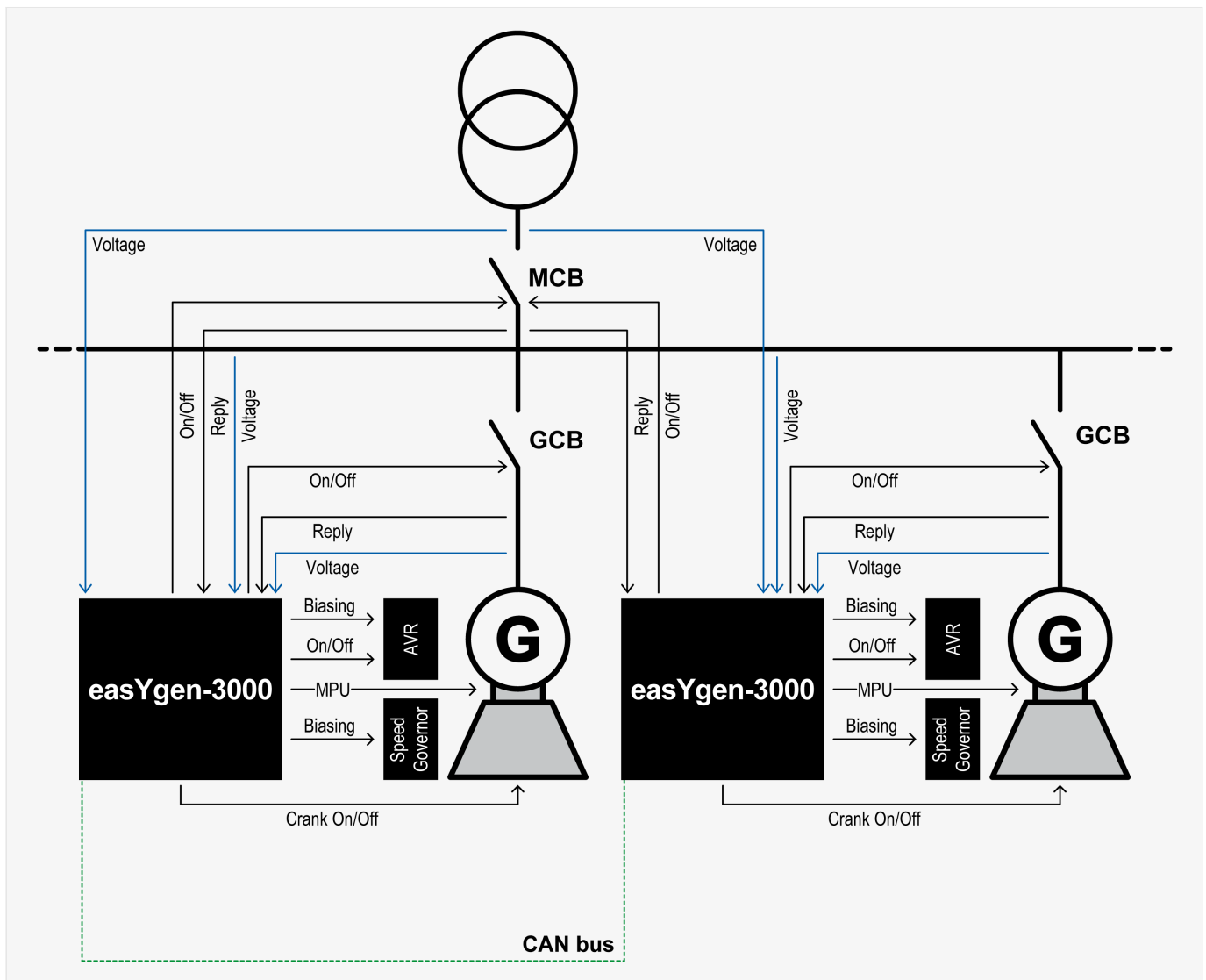

Fig. 327: Application mode GCB/MCB



The breaker transition mode makes no difference during the run-up synchronization.

Run-up synchronization GCB

ID	Parameter	Setting range	Proposal
3435	Run-up synchronization Mode	Off / with GCB / with GCB/GGB	with GCB
3436	Minimum speed for close GCB	0 to 4,000 rpm	000 rpm
3437	Speed for excitation start	0 to 4,000 rpm	600 rpm
3438	Time of participation	1 to 180 s	7 s
3442	Simultaneous excitation	On / Off	Off
12937	Run-up sync.	LogicsManager	Emergency run

Table 126: Run-up synchronization

Preconditions for run-up synchronization in emergency run:

- Mains OK
- GCB open
- Engine(s) are stopped
- Run-up synchronization is released (LogicsManager)

In this example the run-up synchronization shall be executed, if the emergency start (AMF) becomes active. With the start command the easYgen evaluates the condition of the MCB. If the MCB is closed, the unit opens at first the MCB. After successful opening the MCB the unit sets the solenoid valve, the starter and closes the GCB. The unit displays "Run-up synchronization". If the engine reaches the 700 rpm (speed for excitation start) the easYgen activates the excitation. From now on monitoring delay time is decremented from start value "Engine monitoring delay time" (parameter [↩ 3315](#)) until it is expired; then:

- The underfrequency / overfrequency monitoring is activated
- The undervoltage monitoring is activated
- The pickup/frequency monitoring is activated
- The frequency and voltage controller is activated



Run-up synchronization acting on GCB and GGB is not applicable in this application mode. The run-up synchronization is inhibited.

6.3.16.2.4 Run-Up Synchronization without Speed Sensor

General notes**Application**

- Step-up transformer with master and prime mover control

- No speed sensor (signal)
- Application Mode: "GCB", "GCB/LSx", "GCB/MCB" or "GCB/L-MCB"

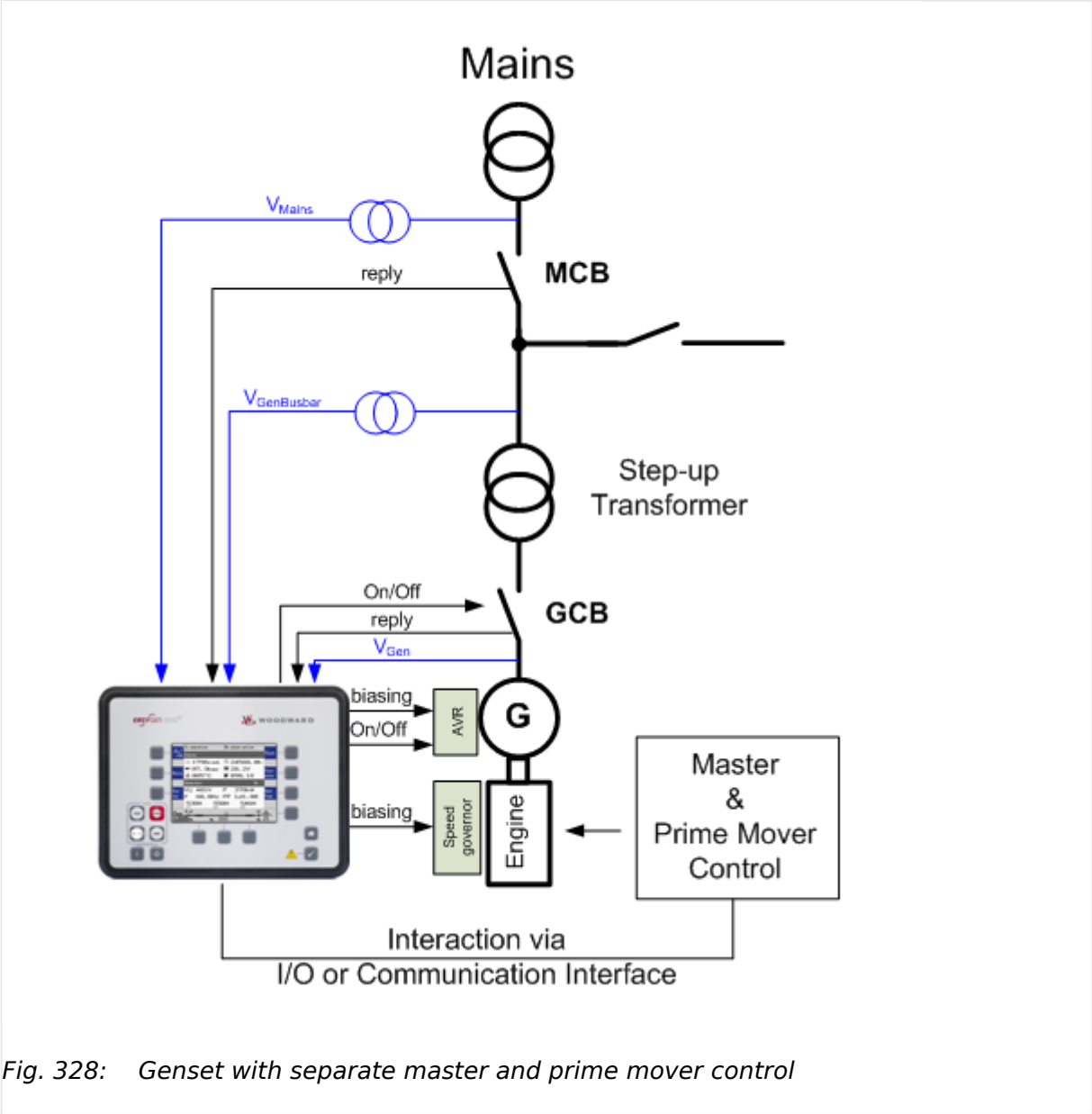

Fig. 328: Genset with separate master and prime mover control

In this application the run up synchronization supports a GCB closure for magnetizing a power transformer. The engine is initiated for start and controlled by an independent control device. The easYgen can support this feature without any speed sensor input as long the Start/Stop mode logic (ID3321) is configured on "Off".

i This mode is only valid for applications in which no parallel start of multiple gensets are required. This mode only supports the single start of a genset with its generator and its power transformer to get it magnetized. If multiple gensets shall be started together the easYgen Start/Stop mode logic must be configured to Diesel, Gas or External and the MPU (speed sensor signal) must be passed to the easYgen.



To run the run-up synchronization correctly it is mandatory **FIRST** to configure as described here.

AFTERWARDS please follow the "Special run-up procedure".

For application correct run-up synchronization, please **configure** the easYgen-XT as follows:

- Application mode must be set up to "GCB", "GCB/LSx", "GCB/MCB" or "GCB/L-MCB"
- The run-up synchronization 3435 must be set up to "with GCB"
- The Minimum speed for close GCB 3436 must be set up to "0" rpm
- The Speed for excitation start 3437 must be set up to "0" rpm
- The Simultaneous excitation 3442 must be set up to "Off"
- The Start/Stop mode logic [↪ 3321](#) must be set up to "Off"
- Check the Engine monitoring delay time [↪ 3315](#).

This time determines how long the easYgen-XT waits enabling the generator monitoring after starting the run-up procedure.



The procedure for run-up a transformer in the application shown above is:



1. ▷ The master control passes the run-up synchronization command to the easYgen-XT: 12937 »Run-up sync«
2. ▷ The master control passes the Start command to the easYgen-XT: [↪ 12120](#) »Start request in AUTO«)
 - ▶ If the MCB is open and the busbar is dead the easYgen-XT closes the GCB
3. ▷ The master control initiates the prime mover start
4. ▷ The master control activates the monitoring delay time with LogicsManager [↪ 12999](#)
 - ▶ The easYgen-XT remains passive until the moment the time delay is passed
5. ▷ If the the monitoring delay time expired
 - ▶ The easYgen-XT starts biasing frequency and voltage according to its setpoint
6. ▷ The master control removes the run-up sync signal
 - ▶ Run-Up synchronization is done

6.3.16.2.5 Application Mode GCB/GGB/MCB

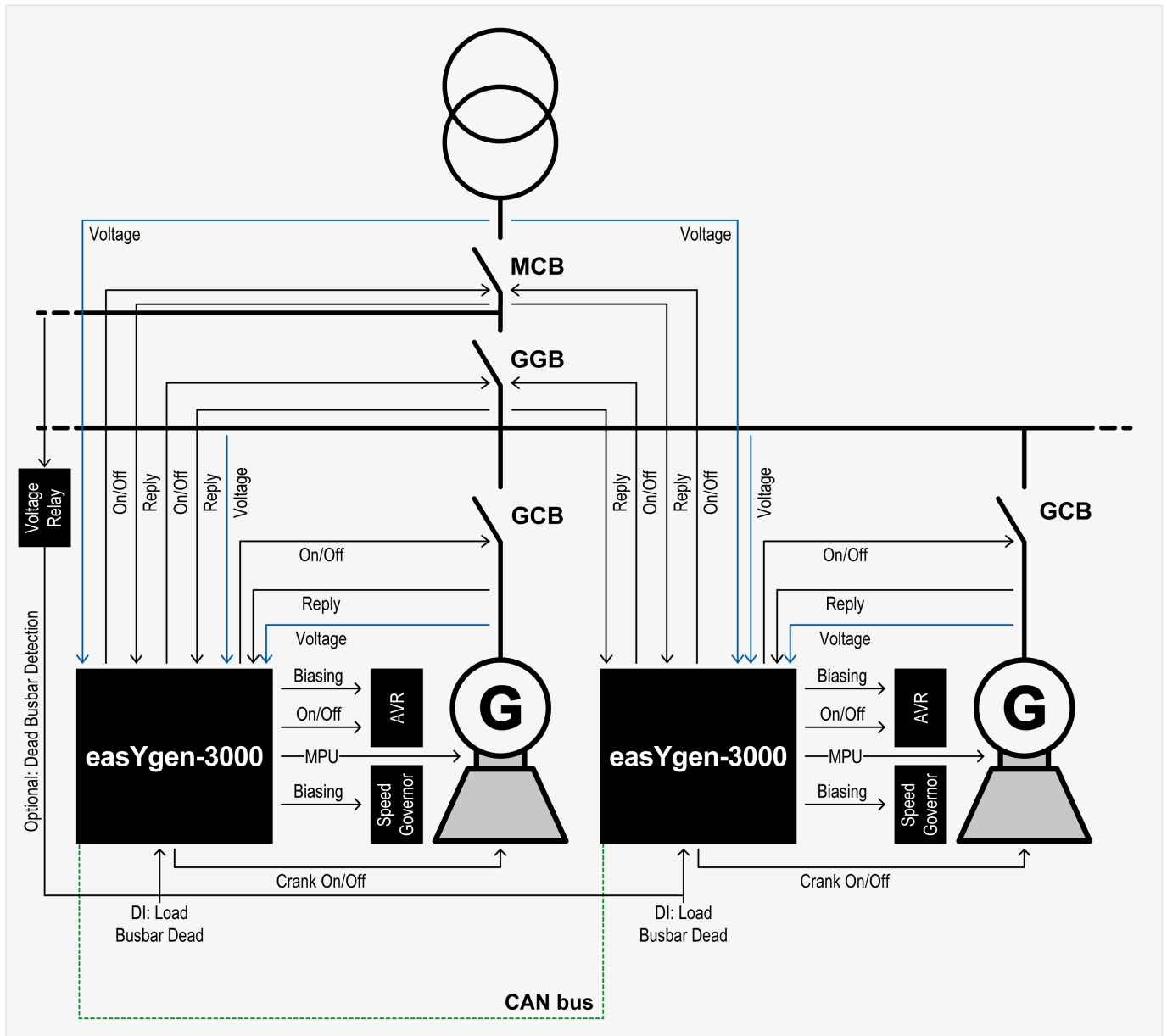

Fig. 329: Application mode GCB/GGB/MCB



The breaker transition mode makes no difference during the run-up synchronization.

Run-up synchronization GCB

ID	Parameter	Setting range	Proposal
3435	Run-up synchronization Mode	Off / with GCB / with GCB/GGB	with GCB
3436	Minimum speed for close GCB	0 to 4,000 rpm	350 rpm

ID	Parameter	Setting range	Proposal
3437	Speed for excitation start	0 to 4,000 rpm	700 rpm
3438	Time of participation	1 to 180 s	7 s
3442	Simultaneous excitation	On / Off	Off
12937	Run-up sync.	LogicsManager	Emergency run

Table 127: Run-up synchronization

ID	Parameter	Setting range	Proposal
3440	Min.Generator power	0.00 to 327.67 MW	—
12936	Bypass min. Pgen.	LogicsManager	—
3441	Voltage monitoring load busbar	On / Off	On

Table 128: GGB control

Preconditions for run-up synchronization in emergency run:

- Mains OK
- GGB open or closed (depending on the GGB mode "ID3422")
- GGB open
- Engine(s) are stopped
- Run-up synchronization is released (LogicsManager)

In the example here the run-up synchronization shall be executed, if the emergency start (AMF) becomes active. Depending on the respective GGB mode, the GGB is opened. With the start command the easYgen sets the solenoid valve, the starter and closes the GCB. The unit displays "Run-up synchronization". If the engine reaches the 700 rpm (speed for excitation start) the easYgen activates the excitation. From now on monitoring delay time is decremented from start value "Engine monitoring delay time" (parameter [↩ 3315](#)) until it is expired; then:

- The underfrequency / overfrequency monitoring is activated
- The undervoltage monitoring is activated
- The pickup/frequency monitoring is activated
- The frequency and voltage controller is activated
- The load will be transferred according to the configured breaker transition mode

Run-up synchronization GCB and GGB

ID	Parameter	Setting range	Proposal
3435	Run-up synchronization Mode	Off / with GCB / with GCB/GGB	with GCB/GGB
3436	Minimum speed for close GCB	0 to 4,000 rpm	350 rpm

ID	Parameter	Setting range	Proposal
3437	Speed for excitation start	0 to 4,000 rpm	700 rpm
3438	Time of participation	1 to 180 s	7 s
3442	Simultaneous excitation	On / Off	Off
12937	Run-up sync.	LogicsManager	Emergency run

Table 129: Run-up synchronization

ID	Parameter	Setting range	Proposal
3440	Min.Generator power	0.00 to 327.67 MW	0.10 MW
12936	Bypass min. Pgen.	LogicsManager	—
3441	Voltage monitoring load busbar	On / Off	On

Table 130: GGB control

Preconditions for run-up synchronization in emergency run:

- Mains OK
- GCB open (depending on the GGB mode "ID3422")
- GGB open
- Engine(s) are stopped
- Run-up synchronization is released (LogicsManager)

In this example, the run-up synchronization shall be executed, if the emergency start (AMF) becomes active. With the start command the easYgen evaluates the condition of the MCB. If the MCB is closed, the unit opens the MCB first. After successfully opening the MCB, the unit sets the solenoid valve and the starter and closes the GCB and GGB. The unit displays "Run-up synchronization". If the engine reaches the 700 rpm (speed for excitation start), the easYgen activates the excitation. From now on, monitoring delay time is decremented from start value "Engine monitoring delay time" (parameter [3315](#)) until it is expired; then:

- The underfrequency / overfrequency monitoring is activated
- The undervoltage monitoring is activated
- The pickup/frequency monitoring is activated
- The frequency and voltage controller is activated

6.3.16.3 Parameter Information

The "Minimum speed for close GCB" (parameter 3436) is 0 rpm:

The GCB (GGB) will be closed from the beginning on during the run-up synchronization start. The advantage of this solution is a clear defined start condition for all participating engines. It is recommended for cases where all gensets are needed for the run-up synchronization and no reserve genset is available.

The "Minimum speed for close GCB" (parameter 3436) is higher than 0 rpm:

The GCB (GGB) will be closed, when the starter has turned the crankshaft successfully. The level is usually set between 100 rpm and under the firing speed level (450 rpm). The advantage of this solution is to save time during the run-up procedure, if more gensets are started as needed. It is recommended for cases where more gensets are available as needed for the run-up synchronization.

The "Speed for excitation start" (parameter 3437):

If the engine reaches the speed for excitation the excitation output will be issued. The speed for excitation must be higher than the firing speed of the engine to make sure the start will be successful.

The "Simultaneous excitation" (parameter 3442):

If the simultaneous excitation is enabled, all participating units, which match the speed limit for excitation will issue their excitation command to the AVRs at the same time.

If the simultaneous excitation is disabled, all participating units, which match the speed limit for excitation will issue their excitation command to the AVRs independent of their neighbors.

The advantage of a simultaneous excitation is to minimize cross currents between the generators during the run-up synchronization. The disadvantage of a simultaneous excitation is the demand of a little bit more time until all units are available for excitation.

The simultaneous excitation makes sense, when high cross currents are expected between the generators during run-up synchronization.

The "Time of participation" (parameter 3438):

The time of participation is the maximum time an engine is accepted during the common run-up synchronization. When the time is over, the single unit interrupts the run-up synchronization and opens the GCB (GGB).

Recommendation:

- The time of participation should be never longer than the starter time (parameter  3306)
- The time of participation should be long enough that the engines can reach their speed for excitation in that time band

The "Engine monitoring delay time" (parameter 3315):

The "Engine monitoring delay time" is also used in the run-up synchronization. It determines the time to wait between activating the excitation and starting monitoring voltage and frequency. Usually the closing of a GGB shall only be executed, when the monitoring delay time is expired. In some cases like emergency run this time can be bypassed to get the GGB faster closed.

6.3.16.4 Commissioning Checklist

The following checklist is guideline to commission the run-up synchronization mode.

- Select the right application mode according to your application. Note that the feedback of the GCB, GGB and MCB is always used according to the chosen

application mode. The "Enable MCB" LogicsManager must be considered in case of running mains parallel.

- Select in case of the application mode GCB/MCB **A04** or GCB/GGB/MCB **A06** the desired transition mode.
- Check at first all breaker feedbacks.
- Enabled
- Make sure that your emergency stop button works.
- Before trying any run-up synchronization function, check each unit with a normal start by setting the LogicsManager "Run-up sync." to "FALSE".
- Do a single start (without run-up synchronization) for each engine to check:
 - Starter
 - Solenoid valve
 - MPU input (speed)
 - Excitation command
 - Generator voltage measurement
 - Optional voltage relay input
 - Busbar voltage measurement
 - Mains voltage measurement (depending on application mode)
 - Generator breaker control
 - Generator group breaker control (depending on application mode)
 - Mains breaker control (depending on application mode)
- Check the synchronization of GCB, GGB and MCB by each unit with single runs.
- Check the frequency, voltage, active power and power factor control by each unit with single runs.
- Check the load share function with all units.
- Check the CAN communication between the single easYgens. Make sure that each unit has its own device identifier and an own Node-ID (usually ID 1, 2, 3 etc. and node identifier 1, 2, 3 etc.). The sequencing window gives you an overview.
- Before you begin with the run-up synchronization make sure, that the physical connection to mains is really open. Later on, if the easYgen shall open the MCB check this again.
- Before you do the first tries with run-up synchronization read this manual and especially the chapter describing your especially application.
- Consider, if you like a GCB closed before issue the crank command (parameter 3437 is set to 0) or after the engine crank shaft is definitely turning (parameter 3437 > 0).

- Consider, if you like simultaneously excitation (parameter 3442 = On] or not. Simultaneously excitation sequence is a little bit longer but can avoid reverse power on the engines, if they very differently come on speed.
- Consider the time of participation (parameter 3438), because the time determines when a member will be removed from the others to continue with a normal start.

6.3.17 LDSS with predicted load

6.3.17.1 Introduction



This function is not usable in the application mode "GCB/GC" **AT3**.

Please read the [↳ "4.4.5.5.6 LDSS with predicted load"](#) first, before you continue. The chapter here shall give you additional information to dedicated application.

Be aware of the two possible modes configurable by parameter 9066 "Predicted load source"):

- **"External":**

The easYgen is autarkic handling the function. The easYgen serves the GGB and the MCB.

- **"Internal":**

The easYgen cooperates with an external ATS control (e.g. Woodward DTSC-200). The ATS control measures the mains power and serves the MCB and GGB. The ATS device communicates over CANopen with the easYgen.



We recommend to ask Woodward for a dedicated application note with configuration examples, if you want go for the external mode.

For parameter refer to [↳ "4.4.5.5.6 LDSS with predicted load"](#). The easYgen informs the user with AnalogManager variables and LogicsManager command variables about their content.

For the relevant analog variables (10.73-10.78, 81.30 and group 21) refer to [↳ "9.4 AnalogManager Reference"](#).

For the relevant logic variables 04.68, 04.69, 86.36, groups 32 - 36 refer to [↳ "9.3.2 Logical Command Variables"](#).

6.3.17.2 Internal source mode (EG3500XT only)

6.3.17.2.1 General

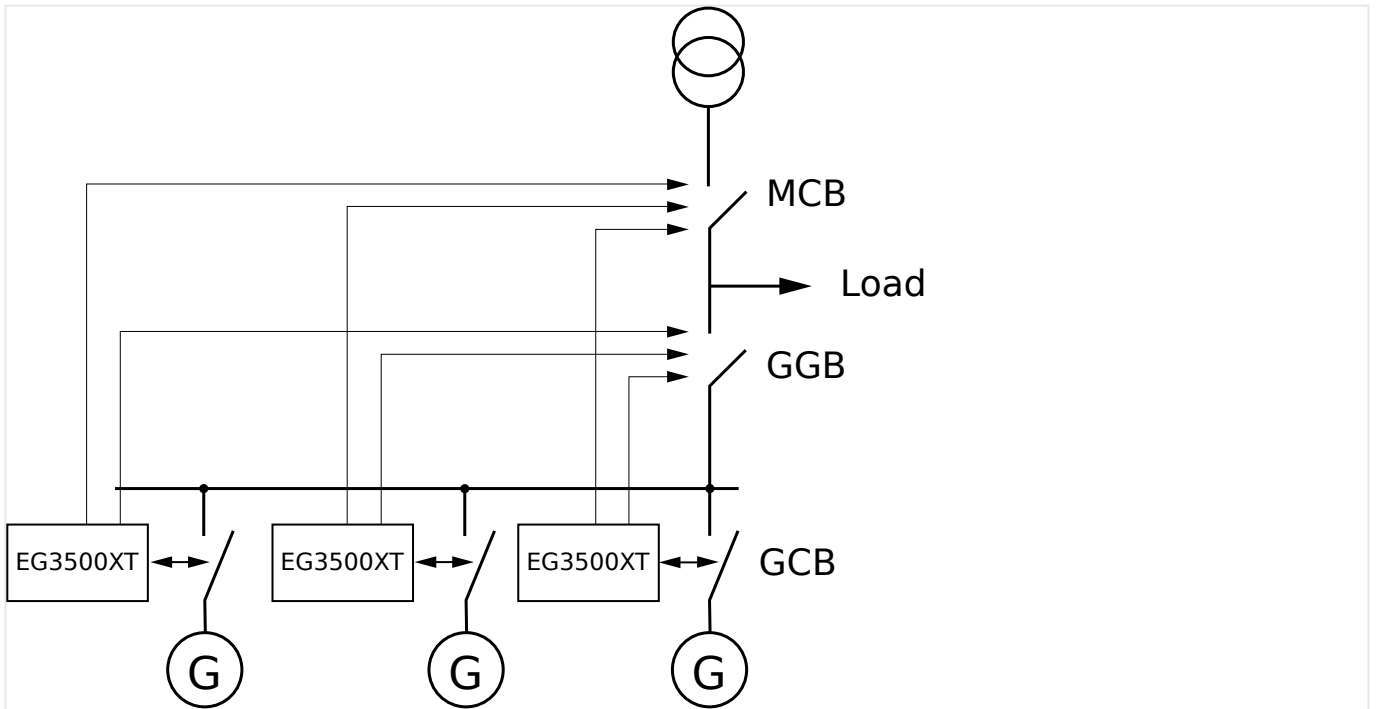

Fig. 330: Example of an application with predicted load source „internal“

Pre-assumption:

The LM 12930 "LD start stop" is TRUE.

The parameter 9066 "Predicted load source" is configured as "Internal".

The LM 15026 "LDSS with predicted load" is TRUE.

The AnalogManager 9059 "AM Consumer load [kW]" passes the mains active power ($02.74 \text{ Mains act.power [W]} * -0.001$) to the LDSS PL function.

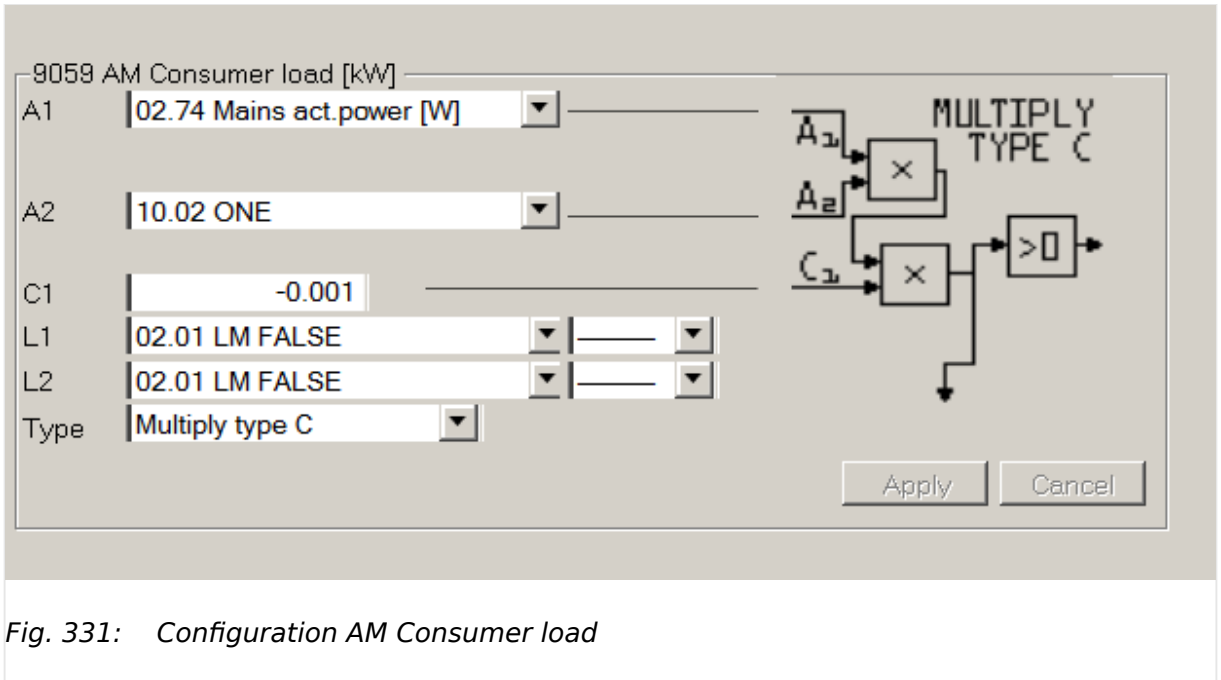

Fig. 331: Configuration AM Consumer load

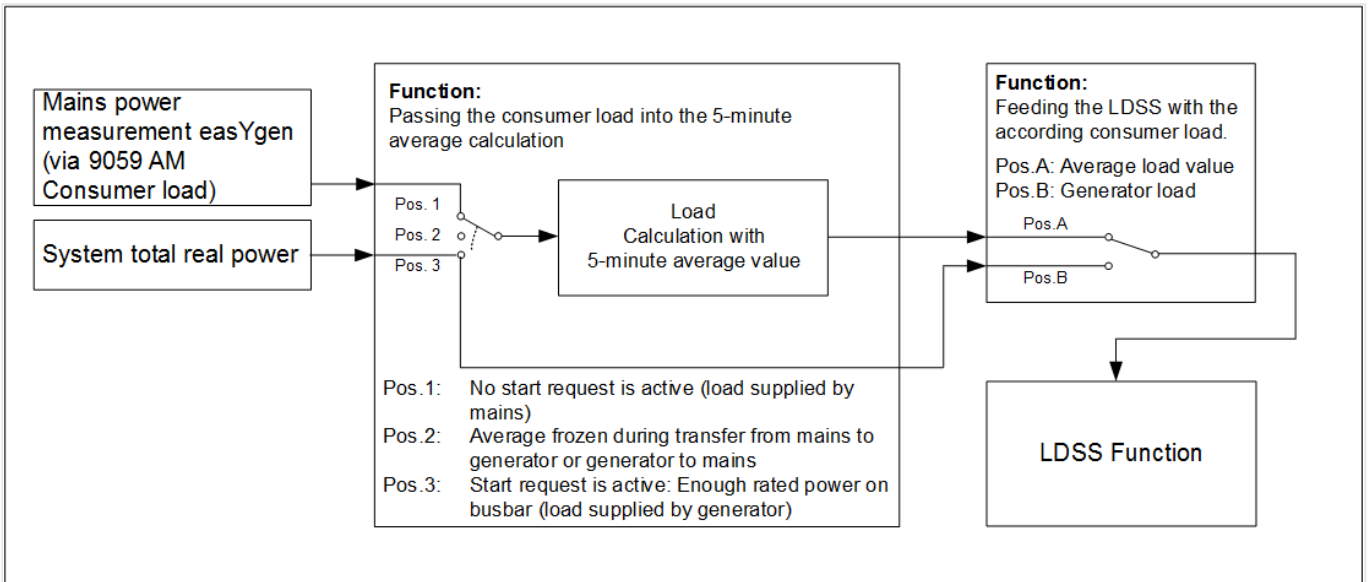

Fig. 332: Schematic of a predicted load with „internal“ source handling

The Procedure:

As long as LM 12120 "Start req. in AUTO" is FALSE, the value of the AM 9059 "AM Consumer load [kW]" goes into the 5-minute average power calculation which is passed to the LDSS.

In that moment the LM 12120 "Start req. in AUTO" becomes TRUE, the last result of the 5-minute average calculation will be kept.

So following procedure is started:

- The configuration 5752 "Start stop mode" is ignored and forced to "Reserve power".
- The GGB close release will be internally blocked in the easYgen and the "04.69 Inhibit ATS" becomes true.

6.3.17.2.2 Example "Emergency power unit" with internal GGB control (only easYgen 3400XT/3500XT)

- The easYgen(s) starts in dead busbar start mode "LDSS", the according amount of engines which are required to maintain the consumer load. (Parameter 5753 "Dead busbar start mode" is ignored in that moment).

If the rated power on the generator busbar is higher than the 5-minute average value plus the active reserve power,

- the internal GGB close will be released and the "04.69 Inhibit ATS" becomes false.
 - The GGB will be closed
- The generator load measurement easYgen is passed to the LDSS. So the LDSS is now working like in the original mode.
- The configuration of 5752 "Start stop mode" is considered again. So the start stop argue could change now.
- The 5-minute average value is now supplied by the real busbar load. Thus the 5-minute average value is still tracked with the consumer load.

The procedure is stopped from that moment on the LM 12120 "Start req. in AUTO" becomes FALSE. The generators will go into cooldown and stop.

6.3.17.2.2 Example "Emergency power unit" with internal GGB control (only easYgen 3400XT/3500XT)

The example here shows what is to do if the easYgen shall start the correct amount of engines in emergency mode. The GGB and MCB is operated by the easYgen. The breaker transition mode is "Open transition".



To incorporate the easYgen emergency mode into the procedure, the flag "04.09 Emergency mode" is to include in the LM 12120 "Start req. in AUTO" .

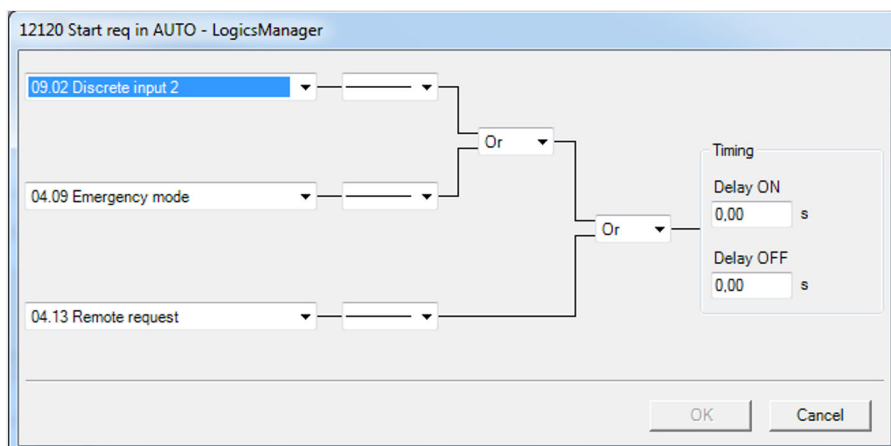

Fig. 333: Including the emergency mode as starting argue.

6 Application Field

6.3.17.2.2 Example "Emergency power unit" with internal GGB control (only easYgen 3400XT/3500XT)

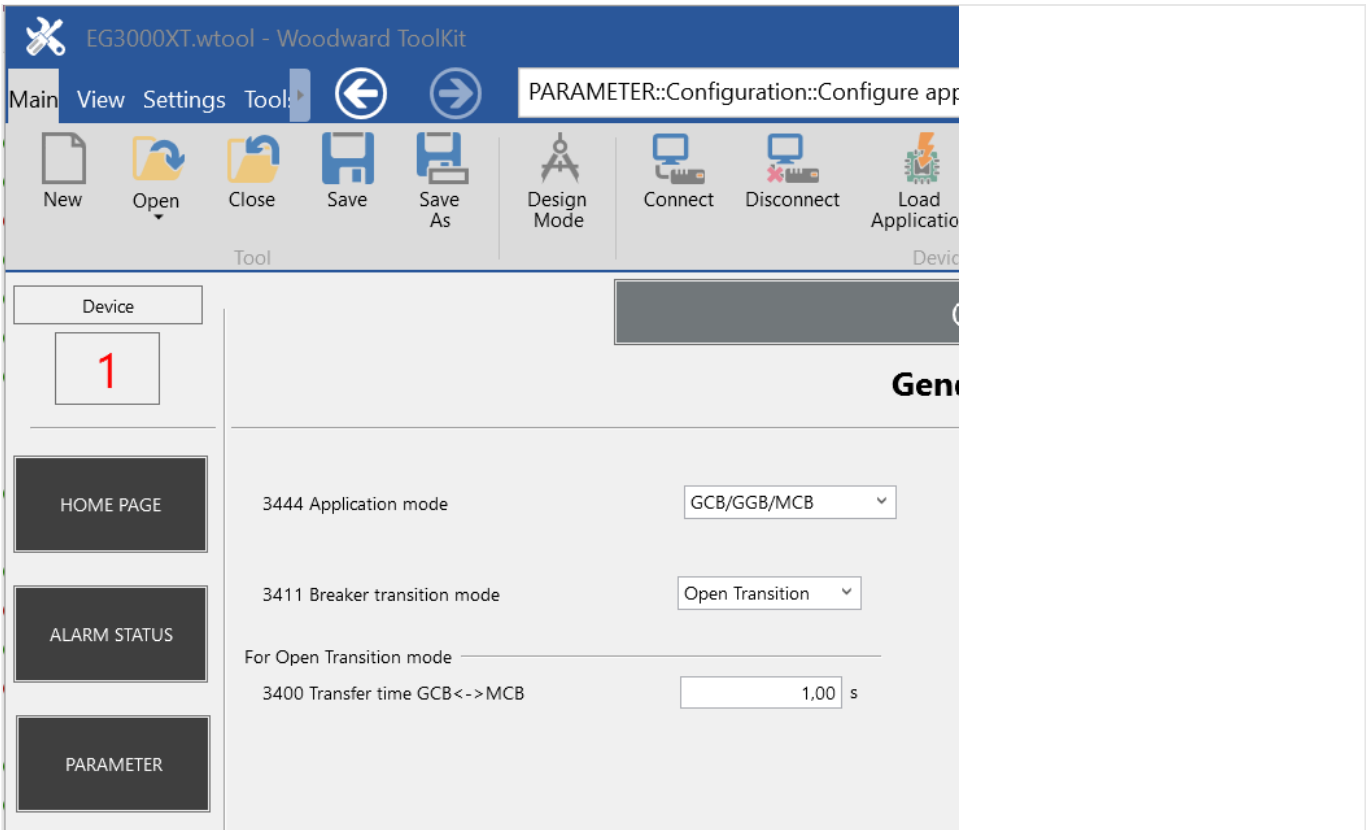

Fig. 334: Example - GGB breaker handling with open transition.

The minimum generator power is set according to the largest expected load. The GGB is released with the signal "04.69 Inhibit ATS". Parameter 3440 "Min. Generator power" is set to the maximum expected load.

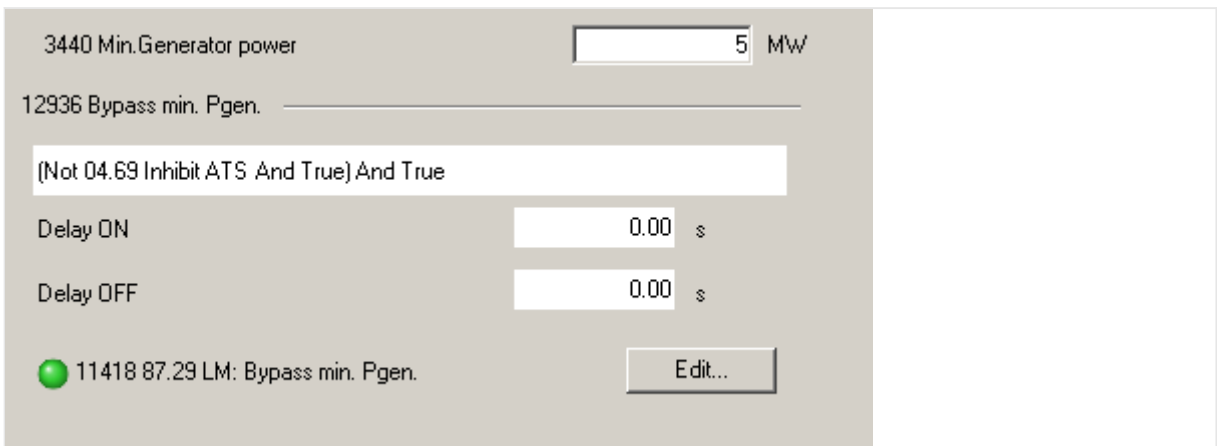

Fig. 335: LM 12936 "Bypass min. Pgen." becomes active if "04.69 Inhibit ATS" is false. That is the case if there is enough generator rated power on busbar.

6.3.17.3 External source mode

6.3.17.3.1 General

The external source mode is basically running like the internal source mode but the mains measurement, the MCB and GGB control is provided by an external control. This control, usually an ATS control (e.g. DTSC-200), sends the mains power and required condition flags as CANopen TPDO messages to the easYgen device. Through configuration of the RPDO in the easYgen the mains power and the condition flags are appearing automatically in the LDSS PL function. The system allows to connect up to 5 ATS controls.



We recommend to ask Woodward for a dedicated application note with configuration examples, if you want go for the external mode.

The external mode contains up to 5 independent "5-minute average value [kW]" calculations. Out of these values "10.78 Average load sum [kW]" is provided.

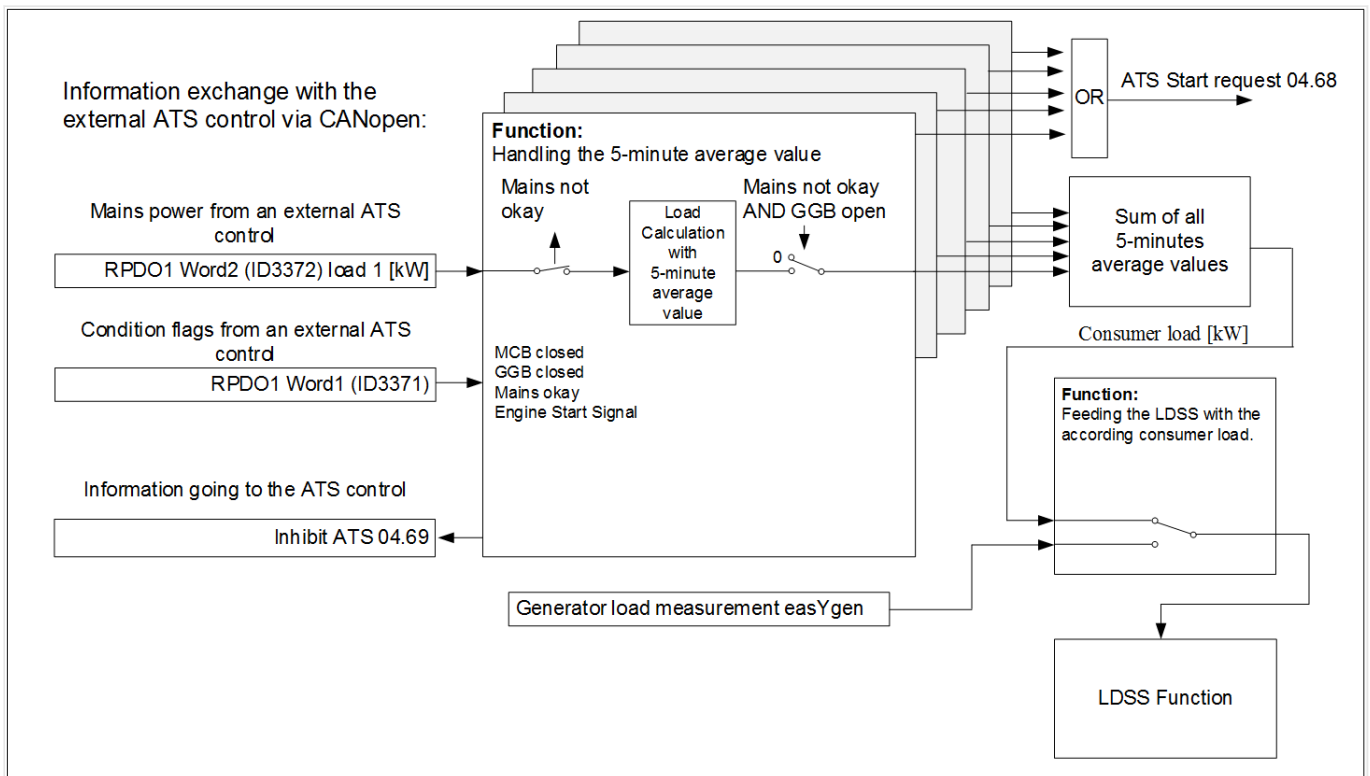

Fig. 336: The principle of the LDSS PL in external source mode

Pre-assumption

The explanation here is performed for an application with one ATS control. The principle is expandable on up to 5 ATS controls.

The LM 12930 "LD start stop" is TRUE.

The parameter 9066 "Predicted load source" is configured as "External".

The LM 15026 "LDSS with predicted load" is TRUE.

The ATS control sends:

- The mains load 1 [kW]
- The MCB condition
- The mains condition
- The GGB condition
- An ATS Start signal

The "04.68 ATS start request" is entered in the LM 12120 "Start req. in AUTO".

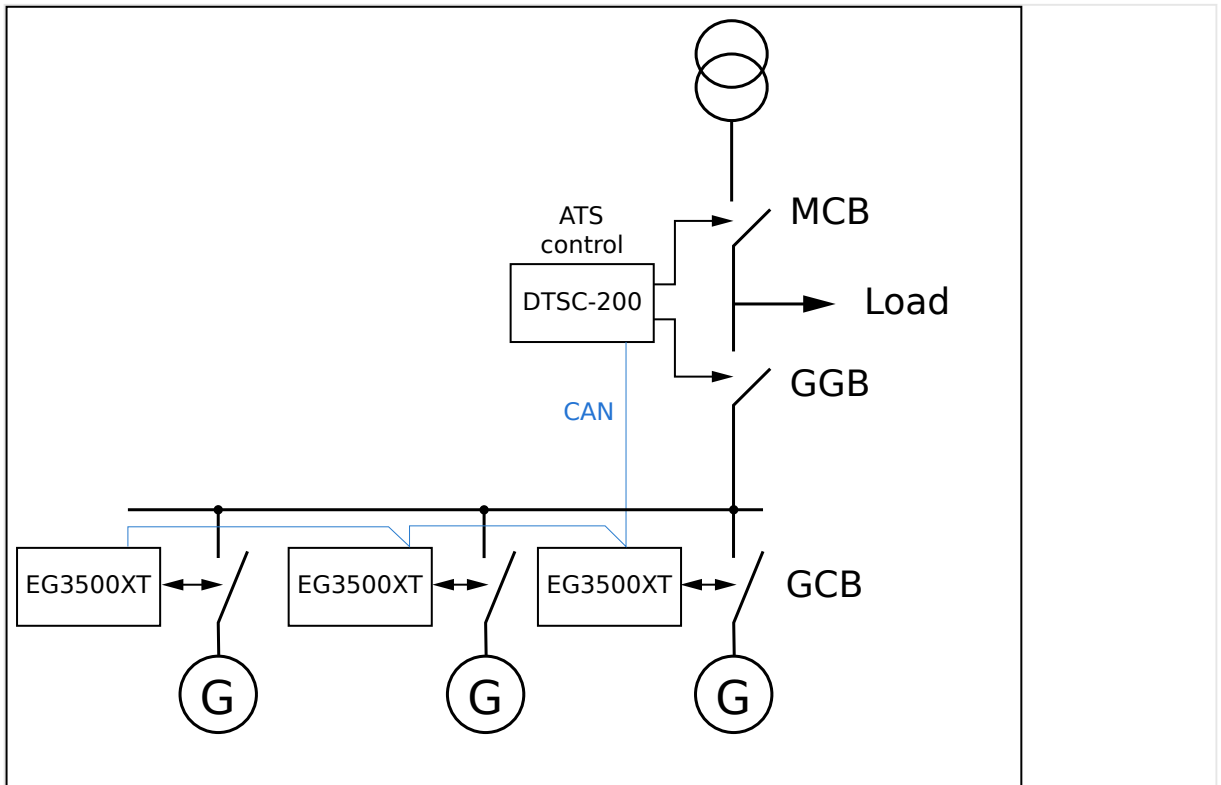

Fig. 337: Example of an application with parameter 9066 "Predicted load source" is configured as "External". Additionally, there is a hardwired inhibit signal from easYgens to the ATS".

Inhibit Signal

To inhibit the switching over of the ATS (e.g. DTCSs) before the nominal power on bus matches the predicted load plus the active reserve power the easYgens activate an inhibit signal.

For this reason every easYgen must have a relay configured with the command variable "04.69 Inhibit ATS". These signals must be hardwired as OR and connected to the ATS inhibit input.

The procedure

As long as LM 12120 "Start req. in AUTO" is FALSE and the MCB is closed, the RPDO1 Word2 (ID3372) load 1 [kW] goes into the individual 5-minute average power calculation.

In the moment the mains fails [see RPDO1 Word1 (ID3371)] the feeding of the 5-minute average value is stopped. So the last result of average calculation will be kept. If the GGB

is open [see RPDO1 Word1 (ID3371)] the value will be passed over as consumer load to the LDSS function.

The ATS start signal from extern [see RPDO1 Word1 (ID3371)] sets the LM command variable "04.68 ATS start request" on TRUE. So the LM 12120 "Start req. in AUTO" becomes TRUE.

- So following procedure is started:
 - The configuration ID5752 "Start stop mode" is ignored and forced to "Reserve power".
 - The flag "04.69 Inhibit ATS" becomes true.
 - The easYgen(s) starts in dead busbar start mode "LDSS", the according amount of engines which are required to maintain the consumer load. (The parameter ID5753 is ignored in that moment).

If the rated power on the generator busbar is higher than the 5-minute average value plus the active reserve power,

- the flag "04.69 Inhibit ATS" becomes false.
 - The ATS closes the GGB
- The generator load measurement easYgen is passed to the LDSS. So the LDSS is now working like in the original mode.
- The configuration ID5752 "Start stop mode" is considered again. So the start stop argue could change now.

The procedure is stopped from that moment on the LM 12120 "Start req. in AUTO" becomes FALSE. The generators will go into cooldown and stop.



The easYgen emergency mode ID2802 must be disabled. The control over the start of the engines is maintained by the ATS control.

6.3.17.3.2 LDSS PL CANopen Handling

The following chapter summarize the CANopen analog and binary variables within the LDSS PL function. If the RPDO mapping is configured the LDSS PL function is supported. Parallel to that the easYgen makes the binary and analog variables available via the Logics- and AnalogManager. (see table below). These values can be taken for visualization or additional logical purposes.

Each ATS must send a transmit PDO with minimal two words (INT16):

- **“Word 1”** with binary flags
 - a. Bit 1-12 empty (0)
 - b. Bit 13 GGB closed
 - c. Bit 14 MCB closed
 - d. Bit 15 Mains okay flag
 - e. Bit 16 ATS start signal

- **“Word 2”** with the mains power [0.1 kW resolution] signed.

These two words are mapped inside the easYgen to according database identifiers.

Binary flags from ATS (Word 1)

The word with the binary flags is filled up on the last 4 bits. This word is mapped in the easYgen to the according database index. (According to the ATS number)

CAN	LogicsManager Command Variable	Bit	ID	Function LDSS PL	ID De- script- ion Field
ATS1: RPDO 1 “Word 1” is mapped to ID 3371	32.13 CAN1 RPDO1.1.13	13	11509	GGB closed	11573
	32.14 CAN1 RPDO1.1.14	14	11510	MCB closed	11574
	32.15 CAN1 RPDO1.1.15	15	11511	Mains OK	11575
	32.16 CAN1 RPDO1.1.16	16	11512	ATS Start signal	11576

CAN	LogicsManager Command Variable	Bit	ID	Function LDSS PL	ID De- script- ion Field
ATS2: RPDO 2 “Word 1” is mapped to ID 3375	33.13 CAN1 RPDO2.1.13	13	11513	GGB closed	11577
	33.14 CAN1 RPDO2.1.14	14	11514	MCB closed	11578
	33.15 CAN1 RPDO2.1.15	15	11515	Mains OK	11579
	33.16 CAN1 RPDO2.1.16	16	11516	ATS Start signal	11580
ATS3: RPDO 3 “Word 1” is mapped to ID 3379	34.13 CAN1 RPDO3.1.13	13	11517	GGB closed	1577
	34.14 CAN1 RPDO3.1.14	14	11518	MCB closed	11578
	34.15 CAN1 RPDO3.1.15	15	11519	Mains OK	11583
	34.16 CAN1 RPDO3.1.16	16	11520	ATS Start signal	11584
ATS4: RPDO 4 “Word 1” is mapped to ID 3383	35.13 CAN1 RPDO4.1.13	13	11521	GGB closed	11585
	35.14 CAN1 RPDO4.1.14	14	11522	MCB closed	11586
	35.15 CAN1 RPDO4.1.15	15	11523	Mains OK	11587
	35.16 CAN1 RPDO4.1.16	16	11524	ATS Start signal	11588
ATS5: RPDO 5 “Word 1” is mapped to ID 3387	36.13 CAN1 RPDO5.1.13	13	11525	GGB closed	11589
	36.14 CAN1 RPDO5.1.14	14	11526	MCB closed	11590
	36.15 CAN1 RPDO5.1.15	15	11527	Mains OK	11591
	36.16 CAN1 RPDO5.1.16	16	11528	ATS Start signal	11592

Table 131: If further ATS are in use:

Mains power [kW] from ATS (Word 2)

The word with mains power is an 16INT signed. This word is mapped in the easYgen to the according database index.

CAN	AnalogManager variable	Function LDSS PL
ATS 1: RPDO 1 "Word 2" is mapped to ID 3372	21.02 CAN1 RPDO1.2	Real power 1 [0.1kW]

If further ATS are in use:

CAN	AnalogManager variable	Function LDSS PL
ATS 2: RPDO 2 "Word 2" is mapped to ID 3376	21.06 CAN1 RPDO2.2	Real power 2 [0.1kW]
ATS 3: RPDO 3 "Word 2" is mapped to ID 3380	21.10 CAN1 RPDO3.2	Real power 3 [0.1kW]
ATS 4: RPDO 4 "Word 2" is mapped to ID 3384	21.14 CAN1 RPDO4.2	Real power 4 [0.1kW]
ATS 5: RPDO 5 "Word 2" is mapped to ID 3388	21.18 CAN1 RPDO5.2	Real power 5 [0.1kW]

6.3.17.3.3 Internally provided analog variables

	These values can be assigned to the analog variables of the Customer screens for visualization.
10.73 Average load 1 [kW]	5 min average of "21.02 CAN1 RPDO1.2 "
10.74 Average load 2 [kW]	5 min average of "21.06 CAN1 RPDO2.2 "
10.75 Average load 3 [kW]	5 min average of "21.10 CAN1 RPDO3.2 "
10.76 Average load 4 [kW]	5 min average of "21.14 CAN1 RPDO4.2 "
10.77 Average load 5 [kW]	5 min average of "21.18 CAN1 RPDO5.2 "
10.78 Average load sum [kW]	If LDSS PL external is active, 10.78 is the load value which is passed to the LDSS. It is the sum of all averages (10.73 - 10.77) which have "Mains not okay" and "GGB not closed". In internal mode it is the value of the 5 min. average of the AM "Consumer load".

	These values can be assigned to the analog variables of the Customer screens for visualization.
81.30 AM Consumer load [kW]	This analog variable provides the load for the LDDS with load prediction in internal source mode.

6.3.17.4 Tables

RPDO Summary

RPDO configuration to get data from ATS 1:

Receive PDO	Database Index	AnalogManager variable	Comment
RPDO1 Word1	3371	21.01 CAN1 RPDO1.1	Binary information
RPDO1 Word2	3372	21.02 CAN1 RPDO1.2	Real power [0.1kW]

RPDO Summary

RPDO configuration to get data from ATS 2:

Receive PDO	Database Index	AnalogManager variable	Comment
RPDO2 Word1	3375	21.05 CAN1 RPDO2.1	Binary information
RPDO2 Word2	3376	21.06 CAN1 RPDO2.2	Real power [0.1kW]

RPDO Summary

RPDO configuration to get data from ATS 3:

Receive PDO	Database Index	AnalogManager variable	Comment
RPDO3 Word1	3379	21.09 CAN1 RPDO3.1	Binary information
RPDO3 Word2	3380	21.10 CAN1 RPDO3.2	Real power [0.1kW]

RPDO Summary

RPDO configuration to get data from ATS 4:

Receive PDO	Database Index	AnalogManager variable	Comment
RPDO4 Word1	3383	21.13 CAN1 RPDO4.1	Binary information
RPDO4 Word2	3384	21.14 CAN1 RPDO4.2	Real power [0.1kW]

RPDO Summary

RPDO configuration to get data from ATS 5:

Receive PDO	Database Index	AnalogManager variable	Comment
RPDO5 Word1	3387	21.17 CAN1 RPDO5.1	Binary information
RPDO5 Word2	3388	21.18 CAN1 RPDO5.2	Real power [0.1kW]

Internally provided LM Command Variables

	ID LMCV	Function
04.68 ATS start request	11983	If this variable is true, LDSS PL wants to start the engines. This command variable is incorporated in the LM "Start request in AUTO".
04.69 Inhibit ATS	11984	This variable is true if "04.68 ATS start request" is true and the rated power on the bus bar is lower than the predicted load (+ active reserve power). It is usually passed internally to release the GGB or external to release the ATS control.
86.36 LM: LDSS predicted	12606	Result of the LM LDSS with load prediction.

6.3.18 Derating And Uprating Of Power (Details)

6.3.18.1 Direct Derating

General notes

The idea of direct derating of power is that the user can control with an analog value, usually from outside, the amount of reduction. For this purposes mainly an analog input would be taken. Additionally in some applications are uprating desired, for example during load sharing procedures, which can be as well executed in determined circumstances.

Derating

If parameter 15149 "Direct Derating" (ID [15149](#)) is enabled, the output value of the AnalogManager 15147 "AM Derating source" determines the derating directly. This derating value is also provided as AnalogManager variable under "81.21 AM Derating source". For derating the active power setpoint, the value shall vary between 100% (no derating) and 0% (full derating). The derating function parameters 15143, 15144, 15145 are not in use.

Uprating

If parameter 15149 "Direct Derating" (ID [15149](#)) is enabled, the output value of the AnalogManager 15147 "AM Derating source" determines the uprating directly. This value is also provided as AnalogManager variable under "81.21 AM Derating source". For uprating the value shall vary between 100% (no uprating) and higher (uprating begins). The scaling with parameters 15143, 15144, 15145 is not in use.

Combined Derating and Uprating

If parameter 15149 "Direct Derating" (ID [15149](#)) is enabled, the output value of the AnalogManager 15147 "AM Derating source" determines the derating/uprating directly. This value is also provided as AnalogManager variable under "81.21 AM Derating source".

For derating the active power setpoint goes under 100%, for uprating the value goes over 100%, and with exact value of 100% the normal setpoint becomes active.

6.3.18.2 Derating With Characteristic Curve

General notes

Some application require a functionality to reduce the active power dependent on a well defined measured value. This could be for example a temperature measurement: The load should decrease with higher temperatures according to a configured characteristic.

If parameter 15149 "Direct Derating" ([↪ 15149](#)) is OFF, the LogicsManager 15146 "Free derating" ([↪ 15146](#)) becomes TRUE and the analog value of power exceeds the value "Start derating at" ([↪ 15143](#)), the unit begins to reduce the present active power setpoint. The grade of reducing depends on the value "Stop derating at" ([↪ 15144](#)) and the value of "Max. power deviation" ([↪ 15145](#)) which are configurable.

If the LogicsManager 15146 "Free derating" becomes FALSE, the unit ramps back to its original setpoint. If derating/uprating is active, the display shows the indication "Derating"/"Uprating".

The derating/uprating function can be used in islanded operation, too. The available rated power from an engine can be reduced (derated) or increased (uprated) with an analog value without adjusting a parameter value. With this function the engine can be individually loaded within of an multiple gen islanded operation (asynchronous load sharing).

Freely scalable derating characteristic

The easYgen-XT offers a characteristic which is linearly decreasing the momentary active power setpoint according to the value offered by the AnalogManager AM Derating source [↪ 15147](#).

The characteristic is defined by the following parameters:

- 15143: "Start derating at"
- 15144: "Stop derating at"
- 15145: "Max. power deviation"

When the LogicsManager 15146 "Free derating" becomes active and the analog value crosses the reducing start value, the configured derating line becomes active. If the derating line falls below the active power setpoint the derating becomes effective. The grade of reduction depends on the reducing stop value and the power deviation freely configurable. If the LogicsManager "Power Reduction" becomes FALSE, the unit shall ramp back to its original setpoint.

To become more familiar please look at the examples below:



Example 1: Mains Parallel Operation (setpoint = below rated power)

- Rated generator power = 200 kW
- Current power setpoint of the generator = 150 kW (75%)
- "Start derating at" = 80 °C water temperature (i.e. analog input AI 01 is defined as free derating source by parameter 15147)
- "Stop derating at" = 90 °C water temperature
- "Max. power deviation" = 40% (80 kW)

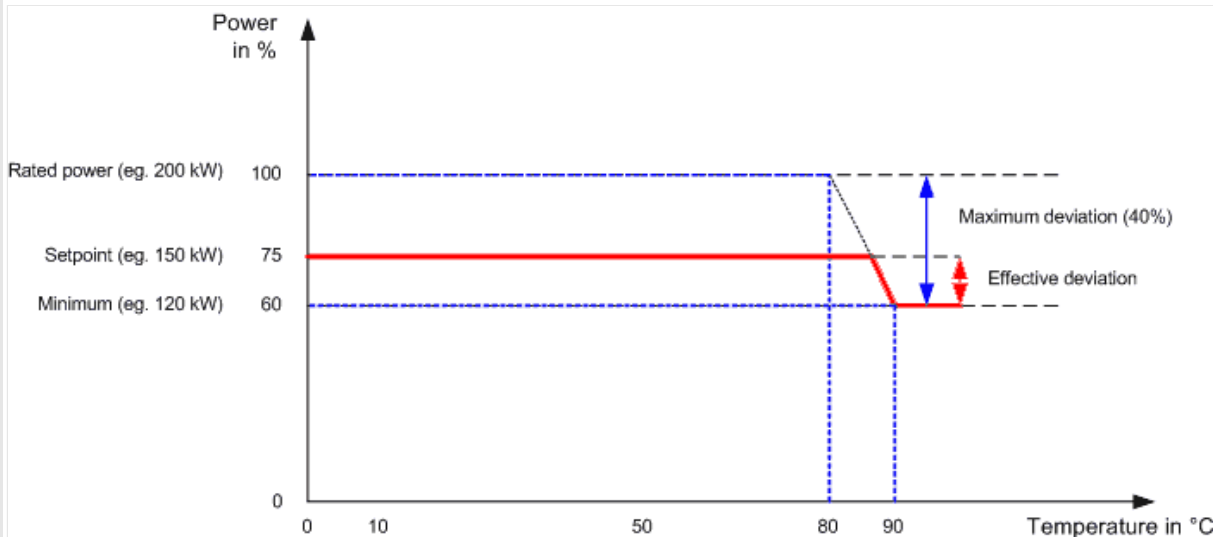

Fig. 338: Derating: Mains parallel operation; setpoint below rated power

If the engine is running and the LogicsManager 15146 "Free derating" is TRUE, the unit monitors the water temperature. If the water temperature remains below the value "Start derating at", the reduction becomes not active and remains on 0%. If the water temperature increases and so exceeds the value Start derating at the reduction becomes active (the unit starts to derate the current active power setpoint). The rate of reduction (slope) is determined by the values of Start derating at, "Stop derating at", and "Max. power deviation" ("Max. power deviation" also defines the minimum power). In this example the power reduction would increase and so reduce power from 75% at 86.5 °C down to 60% = 120 kW at 90 °C. Temperature over 90 °C would cause the same reduction of 40% in this example. So it is guaranteed that the engine is not running with too less load.

A Setpoint below the Minimum (e.g. 55%) would not run into reduction.

With a smaller Maximum deviation (e.g. 20%) Minimum would be higher than Setpoint and so not cause reduction.



Example 2: Mains Parallel Operation (setpoint = rated power)

- Rated generator power = 200 kW
- Current power setpoint of the generator = 200 kW (100%)
- "Start derating at" = 80 °C water temperature (i.e. analog input AI 02 is defined as free derating source by parameter 15147)
- "Stop derating at" = 90 °C water temperature
- "Max. power deviation" = 40% (80 kW)

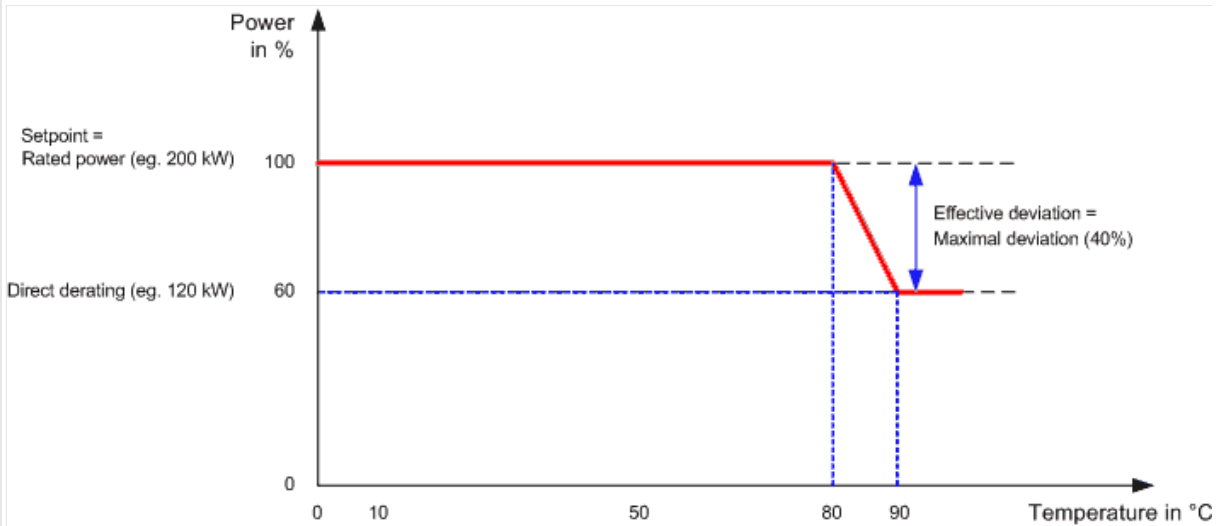

Fig. 339: Derating: Mains parallel operation; setpoint = rated power

If the engine is running and the LogicsManager "Free derating"15146 "Free derating" is TRUE, the unit monitors the water temperature. If the water temperature remains below the value "Start derating at", the reduction becomes not active and remains on 0%. If the water temperature increases and so exceeds the value "Start derating at" the reduction becomes active (the unit starts to derate the current active power setpoint). The rate of reduction (slope) is determined by the values of "Start derating at", "Stop derating at", and "Max. power deviation" ("Max. power deviation" also defines the minimum power).

The power reduction would increase and so reduce power from 100% at 80 °C down to 60% = 120 kW at 90 °C. Temperature over 90 °C would cause the same reduction of 40% in this example. So it is guaranteed that the engine is not running with too less load.



Example 3: Islanded Parallel Operation (IOP)

- Rated generator power = 200 kW
- Current average utilization of all generators = 95%
- "Start derating at" = 80 °C water temperature (i.e. analog input AI 02 is defined as free derating source by parameter 15147)
- "Stop derating at" = 90 °C water temperature
- "Max. power deviation" = 40%

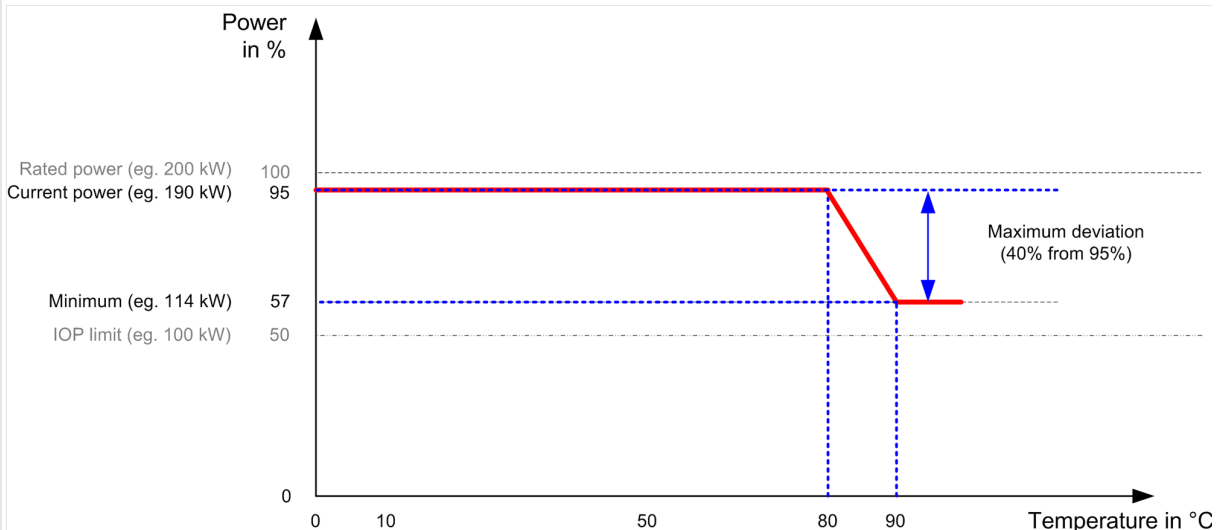

Fig. 340: Derating: Islanded parallel operation

In islanded parallel operation the derating factor is correlated to the utilization factor of all engines! This becomes the new Maximum for derating.

The engine is running with 95% (190 kW). If the LogicsManager is enabled and temperature has reached 80 °C the derating becomes effective (the unit starts to derate the current active power setpoint). If the temperature is 90 °C or higher the maximum reduction value of 40% becomes active. The current power of 95% will be reduced by 40% to 60%.

$$95\% \times 0.6 = 57\% \hat{=} 0.57$$

This engine will run now with $200 \text{ kW} \times 0.57 = 114 \text{ kW}$.



In islanded parallel operation the derating is limited to 50%. It is not possible to get the utilization factor lower than 50% by derating function.

If the derating signals are digital (e.g. different relay outputs from a ripple control receiver; refer to [6.3.14 Ripple Control Receiver](#)), the digital signals can be transformed to an analog signal with a simple set of resistors.

The derating of power has an impact on the Load-Dependent Start/Stop functionality (refer to [6.2.1.1 Configuring Load-Dependent Start/Stop](#)): The start of the next generator will be shifted.

6.3.18.3 J1939 (ECU) Derating

General notes

In some conditions -- for example when knocking of the engine is detected -- the ECU (Engine Control Unit) is requesting a load reduction via J1939 standard message SPN 3644. This message is only supported by some ECUs e.g. Woodward EGS/LECM.

To allow J1939 ECU derating parameter 15142 "J1939 derating" must be configured to "On". The derating value of SPN 3644 is defined as a percentage value related to rated power, with 0% = no derating and 100% = maximum derating (= no load).

If parameter 15142 "J1939 derating" is on and the power P is limited to:

$$P_{lim} = (100\% - \text{derating value}) \times P_{rated} / 100\%$$



In islanded parallel operation this behavior does not meet exactly the derating required by the ECU. Because of the influence of load share, in the first moment the derating is stronger than required by the ECU.

6.3.19 Examples timer configuration

Example 1:

Each day a function shall be activated from 8.12am to 6.48pm (18:48)

- Configure Timer 1: Hour (ID1652) to 8
- Configure Timer 1: Minute (ID1651) to 12
- Configure Timer 1: Second (ID1650) to 0
- Configure Timer 2: Hour (ID1657) to 18
- Configure Timer 2: Minute (ID1656) to 48
- Configure Timer 2: Second (ID1655) to 0
- Take a LogicsManager equation i.e. Internal flag and configure:
 - 11.01 Timer 1 AND
 - 11.02 Timer 2 NOT
- Incorporate this internal flag into the LogicsManager equation which enables the desired function.

Example 2:

Each working day (Monday to Friday) a function shall be activated at 10.15am for the duration of 1 minute

- Configure Active houractive hour (ID1662) to 10
- Configure Active minuteactive minute (ID1661) to 15

- Configure "Active weekdays" (ID1670, 1671,1672,1673,1674; Monday - Friday) to YES
- Configure "Active weekdays" (ID1675, 1676; Saturday - Sunday) to NO
- Take a LogicsManager equation i.e. Internal flag and configure:
 - 11.05 Active hour AND
 - 11.06 Active minute AND
 - 11.03 Active weekdays
- Incorporate this internal flag into the LogicsManager equation which enables the desired function.

Example 3:

Each day a function shall be activated at 7am for the duration of 1 hour

- Configure "11.05 Active hour" (ID1662) to 7
- Take a LogicsManager equation i.e. Internal flag and configure:
 - 11.05 Active hour
- Incorporate this internal flag into the LogicsManager equation which enables the desired function.

Example 4:

Each Monday a function shall be activated at 8.12am and deactivated at Friday 6.48pm (18:48)

- Configure Timer weekly 1: Start day (ID1664) to 1
- Configure Timer weekly 1: Start hour (ID1606) to 8
- Configure Timer weekly 1: Start minute (ID1607) to 12
- Configure Timer weekly 1: Start second (ID1608) to 0
- Configure Timer weekly 1: Stop day (ID1665) to 5
- Configure Timer weekly 1: Stop hour (ID1609) to 18
- Configure Timer weekly 1: Stop minute (ID1610) to 48
- Configure Timer weekly 1: Stop second (ID1611) to 0
- Incorporate 11.14 Timer weekly 1 into a LogicsManager equation which enables the desired function.

6.3.20 LDSS with Interchange, Closed Transit. or Open Transition**Introduction**

In breaker transition mode "Interchange", "Closed Transit." or "Open Transition" the mains parallel operation from the Load-dependent start/stop works different in comparison to the "Parallel" logic.

Please read the chapter [↪ “4.4.5.5 Load Dependent Start/Stop \(LDSS\)”](#) for additional information about the Load-dependent start/stop functionality. The chapter here shall give additional information to the functionality in the mentioned breaker transition modes.

6.3.20.1 LDSS for main parallel-/ isolated operation

Application mode with MCB, for example "GCB/MCB".

The Mains is in range and the MCB is closed.

ID	Parameter	Value	Comment
12930	LD start stop	[(1 & 1) & 1]	Load-dependent start/stop is always enabled
5752	Start stop mode	Reserve power	Load-dependent uses "Reserve power" calculation

- 
- 1.** ▷ Start request in AUTO is active.
- 2.** ▷ If the load at the mains interchange point exceeds the MOP minimum load threshold, the first genset will be added.
 - $PMN_{real} > PMOP_{minimum}$
- 3.** ▷ Load transfer from mains to generator (MCB opens after transfer).
- 4.** ▷ If the reserve power falls below the IOP Reserve power threshold another genset will be added.
 - $P_{Reserve} < P_{Reserve\ IOP}$
- 5.** ▷ Additional genset is in operation.
- 6.** ▷ If the reserve power exceeds the IOP Reserve power threshold plus the hysteresis plus the rated load of the genset, a genset will be stopped.
 - $P_{Reserve} > P_{Reserve\ islanded\ IOP} + P_{hysteresis\ IOP} + P_{RatedGen}$
- 7.** ▷ If the genset is supplying the load and the generator load falls below the MOP minimum load threshold minus the hysteresis, the genset will synchronize back to mains.
 - $PGN\ real\ active < PMOP\ minimum - P_{hysteresis\ MOP}$
- 8.** ▷ Load transfer from generator to mains.

Example

ID	Parameter	Value	Comment
1752	Gen. rated active power [kW]	200	Generator rated power (200kW)
5767	IOP Dynamic	100	Mains minimum power for Generator start (100kW)
5769	MOP Hysteresis	20	Mains hysteresis for Generator stop (20kW)
5760	IOP Reserve power	50	Generator reserve power for starting additional Gens (50kW)
5761	IOP Hysteresis	30	Generator hysteresis for stopping Gens (30kW)

	
1. ▷	Start request in AUTO is active.
2. ▷	If the load at the mains interchange point exceeds the MOP minimum load threshold, the first genset will be added. <ul style="list-style-type: none"> • $PMN_{real} > PMOP_{minimum}$ • $PMN_{real} > 100kW$
3. ▷	Load transfer from mains to generator (MCB opens after transfer).
4. ▷	If the reserve power falls below the IOP Reserve power threshold another genset will be added. <ul style="list-style-type: none"> • $P_{Reserve} < P_{Reserve\ IOP}$ • $P_{Reserve} < 200kW\ (Generator\ rated\ power) - 150kW\ (Load)$ • $P_{Reserve} < 50kW$
5. ▷	Second genset is in operation.
6. ▷	If the reserve power exceeds the IOP Reserve power threshold plus the hysteresis plus the rated load of the genset, the second genset will be stopped. <ul style="list-style-type: none"> • $Preserve > Preserve\ islanded\ IOP + Physteresis\ IOP + P_{RatedGen}$ • $Preserve > 50kW + 30kW + 200kW$ • $Preserve > 280kW$
7. ▷	If the genset is supplying the load and the generator load falls below the MOP minimum load threshold minus the hysteresis, the genset will synchronize back to mains. <ul style="list-style-type: none"> • $PGN\ real\ active < PMOP\ minimum - Physteresis\ MOP$ • $PGN\ real\ active < 100kW - 20kW$ • $PGN\ real\ active < 80kW$
8. ▷	Load transfer from generator to mains (Genset stops after transfer).

6.3.20.2 LDSS only for isolated operation

Application mode with MCB, for example "GCB/MCB".

The Mains is in range and the MCB is closed.

ID	Parameter	Value	Comment
12930	LD start stop	[(Not 04.07 & 1) & 1]	Load-dependent start/stop is enabled if the MCB is open
5752	Start stop mode	Reserve power	Load-dependent uses "Reserve power" calculation
5767	MOP Minimum load	0	Mains minimum power (0kW disables LDSS back to mains)



1. ▷ Start request in AUTO is active, all genset with start request will start.
2. ▷ Load transfer from mains to generator (MCB opens after transfer).
3. ▷ LDSS is enable (configuration MCB is open).
4. ▷ Gensets with open GCB stops and gensets with closed GCB will run for the configured minimum running time.
5. ▷ If the reserve power falls below the IOP Reserve power threshold another genset will be added.
 - $P_{Reserve} < P_{Reserve\ IOP}$

or

If the reserve power exceeds the IOP Reserve power threshold plus the hysteresis plus the rated load of the genset, a genset will be stopped.

 - $P_{Reserve} > P_{Reserve\ islanded\ IOP} + P_{Hysteresis\ IOP} + P_{RatedGen}$
6. ▷ If the Start request in AUTO is changes to "False" the genset transfer the load from generator to mains.
7. ▷ MCB is closed and genset stops.

6.4 CANopen Applications

6.4.1 Remote Control

6.4.1.1 Remote Start/Stop, Shutdown, And Acknowledgment



Refer to [6.3.5 Performing Remote Start/Stop And Acknowledgment](#) for detailed information.

The easYgen may start, stop, shut down, or acknowledge alarms with CAN/Modbus. Therefore, two logical command variables (04.13 and 04.14) have to be configured with the LogicsManager. 03.40 can handle Remote shutdown only.

- 04.13 Remote request
- 04.14 Remote acknowledge
- 03.40 Remote Shutdown

A "03.40 Remote Shutdown" can be configured via LogicsManager internal flag (e.g. 12230 "Flag 1") combined with a free alarm LogicsManager (e.g. 8120 "Free alarm 1") configured with shutdown alarm class.

Two different methods to perform a remote start/stop/Acknowledgment using "04.13 Remote request" and "04.14 Remote acknowledge" are detailed in the below.

These are "Remote start/stop/Acknowledgment via RPDO" and "Remote start/stop/Acknowledgment via default SDO communication channel". The advantages and the disadvantages of these two methods are as follows.

RPDO	Default SDO communication channel
Classical communication for CANopen devices	Configuration process
One message	Two messages
No validation of the received answer	Validation answer, if message has been received by the unit
Only working in operational mode	May take longer in case of communication with two messages

Table 132: Comparison

6.4.1.1.1 RPDO

CANopen Master (parameter  8993) must be enabled, if there is no PLC taking over the master function.

 **Configure CAN interface 1**

1. ▷ Either on the front panel or using ToolKit navigate to menu [Configure CAN interface / Configure CAN interface 1].
2. ▷ Configure the parameter listed below.

ID	Parameter	Value	Comment
8993	CANopen Master	On	CANopen Master is enabled.

 **Configure RPDO**

1. ▷ Either on the front panel or using ToolKit navigate to menu [Configure CAN interface 1 / Receive PDO 1].
2. ▷ Configure the parameters listed below.

ID	Parameter	Value	Comment
9300	COB-ID	00000201 (hex)	COB-ID set to 00000201.
9910	Number of Mapped Objects	1	One mapped object is configured
9911	1. Mapped Object	00503	The 1st mapped object is set to control parameter 503.

 Setting the COB-ID to 201 (hex) is exemplary; usually, the PDOs are in the range of 181 (hex) to 57F (hex).

With this setting, the Receive PDO is configured to overtake the received data coming in by COB-ID 201 into the ID 503. The number of mapped objects is here 1.

Refer to [“9.2.9 Additional Data Identifier”](#) for a list of additional parameter groups.

CANopen message

The following table shows four data examples the device is receiving on the CANopen bus. These data are sent as TPDO to the device (COB-ID 201). The settings above map the received data to the easYgen address ID 503.

ID (hex)	Description	Data (hex)
201	Remote Start	01 00
201	Remote Stop	02 00
201	Remote Acknowledge	sequence of: 0000, 10 00; 0000, 1000
		Notes The message 1000hex must be sent twice to acknowledge an alarm completely. The first rising edge (0000hex followed by 1000hex) disables the horn and the second rising edge resets the alarm.
201	Remote Shutdown	00 02

6.4.1.1.2 Default SDO Communication Channel

Another possibility for a remote start/stop/Acknowledgment is to send the request via default SDO communication channel. The device listens to the CAN ID 600 (hex) + Node-ID internally to perform the desired control, the reply is on CAN ID 580 (hex) + Node-ID.

The following examples show the request format on CANopen with different Node-IDs.

The request on the bus is sent via the control parameter ID 503 of the device.

The value 2000 (hex) is calculated internally:

- 503 (dec) -- 1F7 (hex)
- 1F7+2000 (hex) = 21F7 (hex)

Please note that high and low bytes are exchanged in the sent address. The data (hex) shows the state of parameter 503 to achieve the required control.

Node-ID 1 (standard value)

The following table shows exemplary request data for the device on the CANopen bus.

Identifier	Description	Data (hex)
601	Remote Start	2B F7 21 01 01 00 00 00



Identifier	Description	Data (hex)
601	Remote Stop	2B F7 21 01 02 00 00 00
601	Remote Acknowledge	sequence of: 2B F7 21 01 00 00 00 00, 2B F7 21 01 10 00 00 00; 2B F7 21 01 00 00 00 00, 2B F7 21 01 10 00 00 00; Notes The message 2B F7 21 01 10 00 00 00 must be sent twice to acknowledge an alarm completely. The first rising edge (2B F7 21 01 00 00 00 00 followed by 2B F7 21 01 10 00 00 00) disables the horn and the second rising edge resets the alarm.
601	Remote Shutdown	2B F7 21 01 00 02 00 00

Node-ID (not standard value)

If the Node-ID of the device is intended to be different from the standard value, the parameter "Node-ID CAN bus 1" (parameter  8950) must be configured accordingly. Node-ID 2 is used in the following example.



Configure the Node-ID

1.  Either on the front panel or using ToolKit navigate to menu [Configure CAN interface / Configure CAN interface 1].
2.  Configure the parameter listed below.

ID	Parameter	Value	Comment
8950	Node-ID CAN bus 1	002 (hex)	Node-ID set to 002.

 With this setting, the Node-ID of the CAN interface 1 is set to 002.

The request on the bus is sent via the control parameter 503 of the device.

The hexadecimal value 2000 is calculated internally:

- 503 (dec) -- 1F7 (hex)
- 1F7 (hex) + 2000 (hex) = 21F7 (hex)



Please note that high and low bytes are exchanged in the sent address.

The data (hex) shows the state of parameter 503 to achieve the required control.

The following table shows exemplary request data for the device on the CANopen bus.

Identifier	Description	Data (hex)
602	Remote Start	2B F7 21 01 01 00 00 00

Identifier	Description	Data (hex)
602	Remote Stop	2B F7 21 01 02 00 00 00
602	Remote Acknowledge	sequence of: 2B F7 21 01 00 00 00 00, 2B F7 21 01 10 00 00 00; 2B F7 21 01 00 00 00 00, 2B F7 21 01 10 00 00 00; Notes The message 2B F7 21 01 10 00 00 00 must be sent twice to acknowledge an alarm completely. The first rising edge (2B F7 21 01 00 00 00 00 followed by 2B F7 21 01 10 00 00 00) disables the horn and the second rising edge resets the alarm.
602	Remote Shutdown	2B F7 21 01 00 02 00 00

Additional SDO communication channels

It is also possible to allow several PLCs to start/stop/acknowledge the unit in addition to the default SDO communication channel. Four additional SDO communication channels are provided for this. The additional SDO 127 (dec) is used in the following example.

- 1. ▷ Configure an additional SDO communication channel**
 Either on the front panel or using ToolKit navigate to menu [Configure CAN interface 1 / Additional Server SDOs].
- 2. ▷ Configure the parameters listed below.**

ID	Parameter	Value	Comment
12801	2. Node ID	127 (dec) = 7F (hex)	SDO communication channel is configured to 127

▶ With this setting, an additional SDO communication channel is configured to 127.

The control request is equal to the request via default SDO communication channel, but the device will listen to messages including the configured address as well.

The device listens to the CAN ID 600 (hex) + 2. Node-ID internally to perform the desired control, the reply from the easYgen is sent on CAN ID 580 (hex) + 2. Node-ID.

- Receive CAN ID 67F (hex) (600 (hex) + 7F (hex))
- Receive CAN ID 5FF (hex) (580 (hex) + 7F (hex))

The same is valid for the additional SDO communication channels 3, 4, and 5.

The following table shows exemplary request data for the device on the CANopen bus.

Identifier	Description	Data (hex)
67F	Remote Start	2B F7 21 01 01 00 00 00
67F	Remote Stop	2B F7 21 01 02 00 00 00
67F	Remote Acknowledge	2B F7 21 01 10 00 00 00

Identifier	Description	Data (hex)
67F	Remote Shutdown	2B F7 21 01 00 02 00 00



If parameters are written or read via two or more SDO communication channels at the same time (before the first has answered), the second one will be refused.

6.4.1.2 Transmitting A Frequency Setpoint

It is possible to transmit a frequency setpoint value via the CANopen protocol. Prerequisite for the use of a frequency setpoint via an interface is the configuration of the frequency setpoint sources with AnalogManager "AM Frequency SP1[Hz]" [↪ 5518](#) or AnalogManager "AM Frequency SP2[Hz]" [↪ 5519](#). Refer to [↪ "4.4.4.4 Frequency Control"](#) for detailed information.

The respective frequency setpoint source is to be configured to "05.53 Interface f setp [Hz]".

Two different methods to transmit a frequency setpoint via CANopen are detailed below.

These are "Transmitting a frequency setpoint via RPDO" and "Transmitting a frequency setpoint via default SDO communication channel". The advantages and the disadvantages of these two methods are as follows.

RPDO	Default SDO communication channel
Classical communication for CANopen devices	Configuration process
One message	Two messages
No validation of the received answer	Validation answer, if message has been received by the unit
Only working in operational mode	May take longer in case of communication with two messages

Table 133: Comparison

6.4.1.2.1 RPDO

Configure CAN interface 1

CANopen Master (parameter [↪ 8993](#)) must be enabled, if there is no PLC taking over the master function.



- 1.** ▷ Either on the front panel or using ToolKit navigate to menu [Configure CAN interface / Configure CAN interface 1].
- 2.** ▷ Configure the parameter listed below.

ID	Parameter	Value	Comment
8993	CANopen Master	On	CANopen Master is enabled.

Configure RPDO

- 1. ▷ Either on the front panel or using ToolKit navigate to menu [Configure CAN interface 1 / Receive PDO 1].
- 2. ▷ Configure the parameters listed below.

ID	Parameter	Value	Comment
9300	COB-ID	00000321 (hex)	COB-ID set to 00000321
9910	Number of Mapped Objects	1	One mapped object is configured
9911	1. Mapped Object	00509	The 1st mapped object is set to control parameter 509.

 Setting the COB-ID to 321 (hex) is exemplary; usually, the PDOs are in the range of 181 (hex) to 57F (hex).

With this setting, the Receive PDO is set to the address, for which the device is listening on the bus. The "Number of Mapped Objects" is 1 since 1 mapped object is used. The request on the bus is sent with the control parameter 509 of the device as mapped object 1.

 Refer to [↪ “9.2.9 Additional Data Identifier”](#) for a list of additional parameter groups.

CANopen message

The following table shows exemplary send data for the device on the CANopen bus.

A frequency setpoint of 50.60 Hz is transmitted:

- 5060 (dec) = 13C4 (hex) → C4 13 according to the CANopen protocol

ID (hex)	Description	Data (hex)
321	Remote F setpoint	C4 13

6.4.1.2.2 Default SDO Communication Channel

Another possibility for transmitting a frequency setpoint is to send the value via default SDO communication channel. The device listens to the CAN ID 600 (hex) + Node-ID internally to perform the desired control, the reply is on CAN ID 580 (hex) + Node-ID.

The following example shows the send format on CANopen with Node-ID 1.

The value is sent on the bus via the control parameter 509 of the device.

The hexadecimal value 2000 is calculated internally:

- 509 (dec) -- 1FD (hex)
- 1FD (hex) + 2000 (hex) = 21FD (hex)



Please note that high and low bytes are exchanged in the sent value.

The data (hex) shows the state of parameter 509 to achieve the required control.

The following table shows exemplary send data for the device on the CANopen bus.

Identifier	Description	Data (hex)
601	Remote F setpoint	2B FD 21 01 C4 13 00 00

6.4.1.3 Transmitting A Voltage Setpoint

It is possible to transmit a voltage setpoint value via the CANopen protocol. Prerequisite for the use of a voltage setpoint via an interface is the configuration of the voltage setpoint sources with AnalogManager "AM Voltage SP1 [V]" [↪ 5618](#) or AnalogManager "AM Voltage SP2 [V]" [↪ 5619](#).

Refer to [↪ "4.4.4.1 Voltage Control"](#) for detailed information.

The respective voltage setpoint source is to be configured to "05.59 Interface v setp [V]".

Two different methods to transmit a voltage setpoint setpoint via CANopen are detailed below.

These are "Transmitting a voltage setpoint via RPDO" and "Transmitting a voltage setpoint via default SDO communication channel". The advantages and the disadvantages of these two methods are as follows.

RPDO	Default SDO communication channel
Classical communication for CANopen devices	Configuration process
One message	Two messages
No validation of the received answer	Validation answer, if message has been received by the unit
Only working in operational mode	May take longer in case of communication with two messages



Table 134: Comparison

6.4.1.3.1 RPDO

Configure CAN interface 1

CANopen Master (parameter  8993) must be enabled, if there is no PLC taking over the master function.





1.  Either on the front panel or using ToolKit navigate to menu [Configure CAN interface / Configure CAN interface 1].
2.  Configure the parameter listed below.

ID	Parameter	Value	Comment
8993	CANopen Master	On	CANopen Master is enabled.

Configure RPDO



1.  Either on the front panel or using ToolKit navigate to menu [Configure CAN interface 1 / Receive PDO 1].
2.  Configure the parameters listed below.

ID	Parameter	Value	Comment
9300	COB-ID	00000321 (hex)	COB-ID set to 00000321.
9910	Number of Mapped Objects	1	One mapped object is configured
9911	1. Mapped Object	00510	The 1st mapped object is set to control parameter 510.



Setting the COB-ID to 321 (hex) is exemplary; usually, the PDOs are in the range of 181 (hex) to 57F (hex).

With this setting, the Receive PDO is set to the address, for which the device is listening on the bus. The "Number of Mapped Objects" is 1 since 1 mapped object is used. The request on the bus is sent with the control parameter 510 of the device as mapped object 1.



Refer to  "9.2.9 Additional Data Identifier" for a list of additional parameter groups.

CANopen message

The following table shows exemplary send data for the device on the CANopen bus in line 1.

A voltage setpoint of 412 V is transmitted:

- 412 (dec) = 019C (hex) → 9C 01 according to the CANopen protocol

ID (hex)	Description	Data (hex)
321	Remote V setpoint	9C 01 00 00

6.4.1.3.2 Default SDO Communication Channel

Another possibility for transmitting a voltage setpoint is to send the value via default SDO communication channel. The device listens to the CAN ID 600 (hex) + Node ID internally to perform the desired control, the reply is on CAN ID 580 (hex) + Node ID.

The following example shows the send format on CANopen with Node ID 1.

The value is sent on the bus via the control parameter 510 of the device.

The hexadecimal value 2000 is calculated internally:

- 510 (dec) - 1FE (hex)
- 1FE (hex) + 2000 (hex) = 21FE (hex)



Please note that high and low bytes are exchanged in the sent value.

ID (hex)	Description	Data (hex)
601	Remote V setpoint	23 FE 21 01 9C 01 00 00

The data (hex) shows the state of parameter 510 to achieve the required control.

6.4.1.4 Transmitting A Power Factor Setpoint

It is possible to transmit a power factor setpoint value via the CANopen protocol. Prerequisite for the use of a power factor setpoint via an interface is the configuration of the power factor setpoint source "AM PF/kvar SP1[-/kvar]" (parameter [↪ 5638](#) or parameter "AM PF/kvar SP2[-/kvar]" [↪ 5639](#)).

Refer to [↪ "4.4.4.2 Power Factor Control"](#) for detailed information.

The respective power factor setpoint source is to be configured to "05.12 Interface PF sp [%]".

Two different methods to transmit a power factor setpoint via CANopen are detailed below.

These are "Transmitting a power factor setpoint via RPDO" and "Transmitting a power factor setpoint via default SDO communication channel". The advantages and the disadvantages of these two methods are as follows.

RPDO	Default SDO communication channel
Classical communication for CANopen devices	Configuration process
One message	Two messages
No validation of the received answer	Validation answer, if message has been received by the unit
Only working in operational mode	May take longer in case of communication with two messages

Table 135: Comparison

6.4.1.4.1 RPDO

CANopen Master (parameter  8993) must be enabled, if there is no PLC taking over the master function.

 **Configure CAN interface 1**

1. ▷ Either on the front panel or using ToolKit navigate to menu [Configure CAN interface / Configure CAN interface 1].
2. ▷ Configure the parameter listed below.

ID	Parameter	Value	Comment
8993	CANopen Master	On	CANopen Master is enabled.

 **Configure RPDO**

1. ▷ Either on the front panel or using ToolKit navigate to menu [Configure CAN interface 1 / Receive PDO 1].
2. ▷ Configure the parameters listed below.

ID	Parameter	Value	Comment
9300	COB-ID	00000321 (hex)	COB-ID set to 00000321.
9910	Number of Mapped Objects	1	One mapped object is configured
9911	1. Mapped Object	00508	The 1st mapped object is set to control parameter 508.



Setting the COB-ID to 321 (hex) is exemplary; usually, the PDOs are in the range of 181 (hex) to 57F (hex).

With this setting, the Receive PDO is set to the address, for which the device is listening on the bus. The "Number of Mapped Objects" is 1 since 1 mapped object is used. The request on the bus is sent with the control parameter 508 of the device as mapped object 1.



Refer to [↪ "9.2.9 Additional Data Identifier"](#) for a list of additional parameter groups.

CANopen message

The following table shows exemplary send data for the device on the CANopen bus. A power factor setpoint of 0.85 capacitive/leading is transmitted (64689 (dec) [65536-850] = FCAE (hex) → AE FC according to the CANopen protocol) in line 1. Please note that negative (capacitive or leading) power factor values are deducted from 65536 (dec) or FFFF (hex).

A power factor setpoint of 0.9 inductive/lagging is transmitted in line 2:

- 900 (dec) = 0384 (hex) → 84 03 according to the CANopen protocol.

A power factor setpoint of 1.0 is transmitted in line 3:

- 1000 (dec) = 03E8 (hex) → E8 03 according to the CANopen protocol

ID (hex)	Description	Data (hex)
321	Remote PF Ld 085	AE FC
321	Remote PF LG 090	84 03
321	Remote PF 1.00	E8 03

6.4.1.4.2 Default SDO Communication Channel

Another possibility for transmitting a power factor setpoint is to send the value via default SDO communication channel. The device listens to the CAN ID 600 (hex) + Node-ID internally to perform the desired control, the reply is on CAN ID 580 (hex) + Node-ID.

The following example shows the send format on CANopen with Node-ID 1.

The value is sent on the bus via the control parameter 508 of the device.

The hexadecimal value 2000 is calculated internally:

- 508 (dec) -- 1FC (hex)
- 1FC (hex) + 2000 (hex) = 21FC (hex)



Please note that high and low bytes are exchanged in the sent value.

The data (hex) shows the state of parameter 508 to achieve the required control.

The following table shows exemplary send data for the device on the CANopen bus.

Identifier	Description	Data (hex)
601	Remote PF Ld 085	2B FC 21 01 AE FC 00 00
601	Remote PF LG 090	2B FC 21 01 84 03 00 00
601	Remote PF 1.00	2B FC 21 01 E8 03 00 00

6.4.1.5 Transmitting A Power Setpoint

It is possible to transmit a power setpoint value via the CANopen protocol. Prerequisite for the use of a power setpoint via an interface is the configuration of the power setpoint sources with AnalogManager "AM ActPower SP1 [kW]" [↪ 5539](#), AnalogManager "AM ActPower SP2 [kW]" [↪ 5540](#), "AM ActPower SP3 [kW]" [↪ 5606](#) or "AM ActPower SP4 [kW]" [↪ 5609](#).

Refer to [↪ "4.4.4.5 Load Control"](#) for detailed information).

The respective power setpoint source is to be configured to "05.56 Interface P setp [kW]".

Please note that the type of the power setpoint (Steady, Import, or Export) must also be defined by parameter "Load setpoint 1", ([↪ 5526](#)), parameter "Load setpoint 2" ([↪ 5527](#) for), parameter "Load setpoint 3" ([↪ 5796](#)) or parameter "Load setpoint 4" ([↪ 5999](#)).

Two different methods to transmit a power setpoint via CANopen are detailed below.

These are "Transmitting a power setpoint via RPDO" and "Transmitting a power setpoint via default SDO communication channel". The advantages and the disadvantages of these two methods are as follows.

RPDO	Default SDO communication channel
Classical communication for CANopen devices	Configuration process
One message	Two messages
No validation of the received answer	Validation answer, if message has been received by the unit
Only working in operational mode	May take longer in case of communication with two messages

Table 136: Comparison

6.4.1.5.1 RPDO

Configure CAN interface 1

CANopen Master (parameter [↪ 8993](#)) must be enabled, if there is no PLC taking over the master function.

- 1.** ▷ Either on the front panel or using ToolKit navigate to menu [Configure CAN interface / Configure CAN interface 1].
- 2.** ▷ Configure the parameter listed below.

ID	Parameter	Value	Comment
8993	CANopen Master	On	CANopen Master is enabled.

Configure RPDO



1. ▷ Either on the front panel or using ToolKit navigate to menu [Configure CAN interface 1 / Receive PDO 1].

2. ▷ Configure the parameters listed below.

ID	Parameter	Value	Comment
9300	COB-ID	00000321 (hex)	COB-ID set to 00000321.
9910	Number of Mapped Objects	1	One mapped object is configured
9911	1. Mapped Object	00507	The 1st mapped object is set to control parameter 507.



Setting the COB-ID to 321 (hex) is exemplary; usually, the PDOs are in the range of 181 (hex) to 57F (hex).

With this setting, the Receive PDO is set to the address, for which the device is listening on the bus. The "Number of Mapped Objects" is 1 since 1 mapped object is used. The request on the bus is sent with the control parameter 507 of the device as mapped object 1.



Refer to [↪ "9.2.9 Additional Data Identifier"](#) for a list of additional parameter groups.

CANopen message

The following table shows exemplary send data for the device on the CANopen bus in line 1.

A power setpoint of 1000.0 kW is transmitted:

- 10000 (dec) = 2710 (hex) → 10 27 according to the CANopen protocol

ID (hex)	Description	Data (hex)
321	Remote P setpoint	10 27 00 00

6.4.1.5.2 Default SDO Communication Channel

Another possibility for transmitting a power setpoint is to send the value via default SDO communication channel. The device listens to the CAN ID 600 (hex) + Node-ID internally to perform the desired control, the reply is on CAN ID 580 (hex) + Node-ID.

The following example shows the send format on CANopen with Node-ID 1.

The value is sent on the bus via the control parameter 507 of the device.

The hexadecimal value 2000 is calculated internally:

- 507 (dec) -- 1FB (hex)
- 1FB (hex) + 2000 (hex) = 21FB (hex)



Please note that high and low bytes are exchanged in the sent value.

ID (hex)	Description	Data (hex)
601	Remote P setpoint	23 FB 21 01 10 27 00 00

The data (hex) shows the state of parameter 507 to achieve the required control.

The table above shows exemplary send data for the device on the CANopen bus in line 2.

6.4.1.6 Transmitting Multiple Setpoints

A single RPDO can transmit multiple objects. The receive PDO can be used for four objects with 16 bits (2 bytes).

If larger objects - for example 32 bits (4 bytes), like for voltage and power setpoints - are used, the maximum number of objects is reduced.

Configure RPDO



1.
▷
 Either on the front panel or using ToolKit navigate to menu [Configure CAN interface 1 / Receive PDO 1].
2.
▷
 Configure the parameters listed below.

ID	Parameter	Value	Comment
9300	COB-ID	00000321 (hex)	"COB-ID" set to 00000321.
9910	Number of Mapped Objects	3	Three mapped objects are configured
9911	1. Mapped Object	00509	The "1. Mapped Object" is set to control parameter 509.

ID	Parameter	Value	Comment
9912	2. Mapped Object	00507	The "2. Mapped Object" is set to control parameter 507.
9913	3. Mapped Object	00508	The "3. Mapped Object" is set to control parameter 508.



Setting the "COB-ID" to 321 (hex) is exemplary; usually, the PDOs are in the range of 181 (hex) to 57F (hex).

With this setting, the Receive PDO is set to the address, for which the device is listening on the bus. The "Number of Mapped Objects" is 3 since 3 mapped object are used. The request on the bus is sent with the control parameters 509, 507, and 508 of the device as the mapped objects.



Refer to [↪ "9.2.9 Additional Data Identifier"](#) for a list of additional parameter groups.

CANopen message

The following table shows exemplary send data for the device on the CANopen bus in line 1. The following setpoints are transmitted:

- Frequency 50.6 Hz (5060 (dec) = 13C4 (hex) → C4 13 according to the CANopen protocol)
- Power 1000 kW (10000 (dec) = 2710 (hex) → 10 27 according to the CANopen protocol)
- Power factor 0.9 lagging (900 (dec) = 0384 (hex) → 84 03 according to the CANopen protocol)

ID (hex)	Description	Data (hex)
321	Remote F P PF setpoint	C4 13 10 27 00 00 84 03

6.4.1.7 Remotely Changing The Setpoint

It is possible to remotely switch between pre-defined setpoints. This is available for active power, power factor, frequency, and voltage.

The bits 4 to 7 of parameter 504 ([↪ "9.2.9 Additional Data Identifier"](#)) are carrying the settings and are available in CAN bus and Modbus protocols. Each bit may be used as input of the according setpoint switching LogicsManager.

ID	Parameter	Setting range	Data type
504	Remote control word 2	Yes / No	UNSIGNED 16

Table 137: Remote Control word »504«: switching between setpoints

In order to switch to another setpoint, the respective bit of object 21F8 (hex), i.e. parameter 504, must be enabled. The following bits are used for this:

Bit "x" of Parameter 504 remotely requests to switch to	... is available as LogicsManager command variable	... uses LogicsManager "y" to switch
Bit 4	Spannungssollwert 2	"04.37 Remote volt. setp. 2"	12920; "86.83 LM: Setp. 2 voltage"
Bit 5	Frequency setpoint 2	"04.38 Remote freq. setp. 2"	12918; "86.81 LM: Setpoint 2 freq."
Bit 6	Power factor setpoint 2	"04.39 Remote PF setp. 2"	12921; "86.84 LM: Setp.2 pwr.factor"
Bit 7	Active power setpoint 2	"04.40 Remote pwr. setp. 2"	12919; "86.82 LM: Setp. 2 load"
			12998; "87.67 LM: Setp. 3 load"
			12969; "87.75 LM: Setp. 4 load"
			Notes This LogicsManager command variable can be used to switch to each available load setpoint.



Additionally/alternatively to remotely changing the control setpoints, it is possible to use "remote" setpoints (values) defined via interface instead of the internal setpoints as data source in the respective controller. For example, use data source "05.53 Interface f setp [Hz]" instead of "05.51 Internal f setp1 [Hz]" in AnalogManager "AM Frequency SP1[Hz]"  5518 to transmit a frequency setpoint via interface.

Two different methods for remotely switch between setpoints via CANopen are detailed below.

These are switching between setpoints via »RPDO« or »Default SDO communication channel«. The advantages and the disadvantages of these two methods are as follows:

RPDO	Default SDO communication channel
Classical communication for CANopen devices	Configuration process
One message	Two messages
No validation of the received answer	Validation answer, if message has been received by the unit
Only working in operational mode	May take longer in case of communication with two messages

Table 138: Comparison CANopen methods

6.4.1.7.1 RPDO

CANopen Master (parameter  8993) must be enabled, if there is no PLC taking over the master function.



Configure CAN interface 1

1. 

Either on the front panel or using ToolKit navigate to menu [Configure CAN interface / Configure CAN interface 1].

2. ▷ Configure the parameter listed below.

ID	Parameter	Value	Comment
8993	CANopen Master	On	CANopen Master is enabled.



Configure RPDO

1. ▷ Either on the front panel or using ToolKit navigate to menu [Configure CAN interface 1 / Receive PDO 1].

2. ▷ Configure the parameters listed below.

ID	Parameter	Value	Comment
9300	COB-ID	00000321 (hex)	COB-ID set to 00000321.
9910	Number of Mapped Objects	1	One mapped object is configured
9911	1. Mapped Object	00504	The "1. Mapped Object" is set to control parameter 504.



Setting the COB-ID to 321 (hex) is exemplary; usually, the PDOs are in the range of 181 (hex) to 57F (hex).

With this setting, the Receive PDO is set to the address, for which the device is listening on the bus. The "Number of Mapped Objects" is 1 since 1 mapped object is used. The request on the bus is sent with the control parameter 504 of the device as mapped object 1.

CANopen message

The following table shows exemplary send data for the device on the CANopen bus. The respective bits are enabled by sending the data of the respective lines.

ID (hex)	Description	Data (hex)
321	Remote P setpoint 2	80 00
321	Remote PF setpoint 2	40 00
321	Remote F setpoint 2	20 00
321	Remote V setpoint 2	10 00

6.4.1.7.2 Default SDO Communication Channel

Another possibility for changing a setpoint is to enable the bit via default SDO communication channel. The device listens to the CAN ID 600 (hex) + Node-ID internally to perform the desired control, the reply is on CAN ID 580 (hex) + Node-ID.

The following example shows the send format on CANopen with Node-ID 1.

The value is sent on the bus via the control parameter ID 504 of the device.

The hexadecimal value 2000 is calculated internally:

- 504 (dec) -- 1F8 (hex)
- 1F8 (hex) + 2000 (hex) = 21F8 (hex)

Please note that high and low bytes are exchanged in the sent value.

The data (hex) shows the state of parameter 504 to achieve the required control.

The following table shows exemplary send data for the device on the CANopen bus.

Identifier	Description	Data (hex)
601	Remote P setpoint 2	2B F8 21 01 80 00 00 00
601	Remote PF setpoint 2	2B F8 21 01 40 00 00 00
601	Remote F setpoint 2	2B F8 21 01 20 00 00 00
601	Remote V setpoint 2	2B F8 21 01 10 00 00 00

6.4.1.8 Transmitting A Remote Control Bit

It is possible to transmit a remote control bit via the CANopen protocol. Such a remote control bit can be sent by a PLC to remotely control the easYgen if this remote control bit is used as a command variable in a LogicsManager function.

Configure RPDO

1.
▷
 Either on the front panel or using ToolKit navigate to menu [Configure CAN interface 1 / Receive PDO 1].
2.
▷
 Configure the parameters listed below.

ID	Parameter	Value	Comment
9300	COB-ID	00000334 (hex)	"COB-ID" set to 00000334.
9910	Number of Mapped Objects	1	One mapped object is configured
9911	1. Mapped Object	00505	The "1. Mapped Object" is set to control parameter 505.

Setting the COB-ID to 334 (hex) is exemplary; usually, the PDOs are in the range of 181 (hex) to 57F (hex).

With this setting, the Receive PDO is set to the address, for which the device is listening on the bus. The "Number of Mapped Objects" is 1 since 1 mapped object is used. The request on the bus is sent with the control parameter 505 of the device as mapped object 1.



Refer to [9.2.9 Additional Data Identifier](#) for a list of additional parameter groups.

CANopen message

The following table shows exemplary send data for the device on the CANopen bus.

Remote control bit 1 is set:

- 1 (dec) = 0001 (hex) → 01 00 according to the CANopen protocol

ID (hex)	Description	Data (hex)
334	Remote Control Bit 1 (PDO)	01 00

6.4.1.8.1 Default SDO Communication Channel

Another possibility for transmitting a power setpoint is to send the value via default SDO communication channel. The device listens to the CAN ID 600 (hex) + Node-ID internally to perform the desired control, the reply is on CAN ID 580 hex) + Node-ID.

The following example shows the send format on CANopen with Node-ID 1.

The value is sent on the bus via the control parameter 249 of the device.

The hexadecimal value 2000 is calculated internally:

- 249 (dec) -- 1F9 (hex)
- 1FB (hex) + 2000 (hex) = 21F9 (hex)



Please note that high and low bytes are exchanged in the sent value.

ID (hex)	Description	Data (hex)
601	Remote Control Bit 1 (SDO)	2B F9 21 01 01 00 00 00

The data (hex) shows the state of parameter 249 to achieve the required control.

The table above shows exemplary sends data for the device on the CANopen bus in line 2.

6.4.2 Sending A Data Protocol via TPDO

This is a configuration example for sending an object (data protocol 5003) on CAN ID 2AE (hex) every 20 ms on TPDO1. For this, TPDO1 must be configured as follows:

⚙️

1. ▷ Either on the front panel or using ToolKit navigate to menu [Configure CAN interface 1 / Transmit PDO 1].
2. ▷ Configure the parameters listed below.

ID	Parameter	Value	Comment
9600	COB-ID	000002AE (hex)	COB-ID set to 000002AE.
9602	Transmission type	255	The number of required sync messages is set to 255.
9604	Event timer	20 ms	Object is sent every 20 ms.
8962	Selected Data Protocol	5003	Data protocol 5003 is used.
9609	Number of Mapped Objects	0	No mapped object is configured

The data to be sent (Mapped Objects) may be provided on request by configuring the "COB-ID SYNC Message" (parameter ↩️ 9100) and the "Transmission type" (parameter ↩️ 9602, ↩️ 9612, ↩️ 9622, ↩️ 9632, or ↩️ 12793) of a TPDO. The unit is requested to send its data by sending a Sync Message.

The number of required Sync Messages is determined by the setting of the Transmission Type.

If the data is to be sent on request, Bit 30 of the "COB-ID SYNC Message" (parameter ↩️ 9100) must be configured to "0" and the "CANopen Master" (parameter ↩️ 8993) function must be configured to "Off".

Additional example

The "Transmission type" of TPDO 1 (parameter ↩️ 9602) is configured to "2" in the following example. This means that a message of the configured TPDO is sent by the unit after two Sync Messages have been sent to the unit.

⚙️

1. ▷ Either on the front panel or using ToolKit navigate to menu [Configure CAN interface 1 / Transmit PDO 1].
2. ▷ Configure the parameters listed below.

ID	Parameter	Value	Comment
9600	COB-ID	000002AE (hex)	COB-ID set to 000002AE.
9602	Transmission type	2	The number of required sync messages is set to 2.

ID	Parameter	Value	Comment
9604	Event timer	20 ms	Object is sent every 20 ms.
8962	Selected Data Protocol	5003	Data protocol 5003 is used.
9609	Number of Mapped Objects	0	No mapped object is configured

The recorded data shows that the data of the Mapped Object (in this example Mux 5) is sent (↪ Table 139) after sending the Sync Message twice (↪ Table 140).

ID (hex)	Description	Data (hex)
80	-	-

Table 139: Cyclical sending of data - sync message request

No.	Count	ID (hex)	Data (hex)
1	2	80	-
2	1	2AE	8B 13

Table 140: Cyclical sending of data - reply

6.4.3 Troubleshooting

General diagnosis

Error	Possible diagnosis
Connected device (Phoenix I/O board) cannot be configured	Are all LEDs at the expansion modules illuminated green (i.e. correctly connected)?
	Are all modules detected (i.e. no blinking expansion module)?

CAN interface 1 (guidance level) diagnosis

Error	Possible diagnosis
No data is sent by the Woodward controller	Is the unit in operational mode (heartbeat - CAN ID 700 (hex) + Node-ID has the content 5 (hex)?
	Are the TPDOs correctly configured (CAN ID, mapping, parameter)?
No data is received by the Woodward controller	Is the unit in operational mode (heartbeat - CAN ID 700 (hex) + Node-ID has the content 5 (hex)?
	Are the RPDOs correctly configured (CAN ID, mapping, parameter)?
No monitoring bit data is received on the RPDO	Is the CAN bus connected correctly?
	Is the baud rate configured correctly?
	Is the CAN ID assigned more than once?
	Is the unit in operational mode? If not, start it via another device or put in NMT Master (parameter ↪ 8993).

Error	Possible diagnosis
	No SDOs (configuration messages) are received by the unit
No SDOs (configuration messages) are received by the unit	Is the CAN ID assigned more than once?
	Is the CAN ID 600 (hex) + Node-ID of the easYgen already used in a PDO (COB-ID)?
	Are RPDOs or TPDOs higher then 580 (hex) or lower than 180 (hex) used?

6.5 Modbus Applications



Data Format(s)

Modbus registers are read and written according to the Modbus standard as Big-endian.

Composite data types like LOGMAN, ANALOGMANAGER, and TEXT use separate descriptions.

6.5.1 Remote Control

6.5.1.1 Remote Start/Stop, Shutdown, And Acknowledgment

The Woodward controller may be configured to perform start/stop/Acknowledgment functions remotely through the Modbus protocol. The required procedure is detailed in the following steps.



Please find remote control parameter 505 described at: [↪ “ Remote control word 3”](#). It works similar like 503 described below.



The following descriptions refer to the remote control parameter 503 as described in [↪ “9.2.9 Additional Data Identifier”](#).

It may be necessary to shift the address by 1 depending on the used PC software. In this case, the address would be 504 for example.

Be sure to check both possibilities in case of remote control problems.

ID	Parameter	Setting range	Data type
503	Remote control 1	0 to 65535	UNSIGNED 16

- Modbus address = 40000 + (Par. ID +1) = 40504
- Modbus length = 1 (UNSIGNED 16)

In order to issue a command, the respective bit of object 21F7 (hex), i.e. parameter 503, must be enabled. The following bits are used for this:

- Bit 0 Start bit:

This bit activates the LogicsManager command variable "04.13 Remote request" and enables a remote start.

- Bit 1 Stop bit:

This bit deactivates the LogicsManager command variable "04.13 Remote request" and disables a remote start.

- Bit 4 Acknowledgment bit:

This bit activates the LogicsManager command variable "04.14 Remote acknowledge". This bit must be set and reset twice to acknowledge an alarm completely. The first rising edge disables the horn and the second rising edge resets the alarm.

- Bit 9 Shutdown Command bit:

This bit activates the LogicsManager command variable "03.40 Remote Shutdown-Status". With this function the engine is immediately shut down without auxiliary service and cool down. This works independent from beaker conditions.

The following Modscan32 screenshot ( Fig. 341) shows the configurations made to remote control parameter 503. It is possible to set the format to binary to view single bits using the "display options".

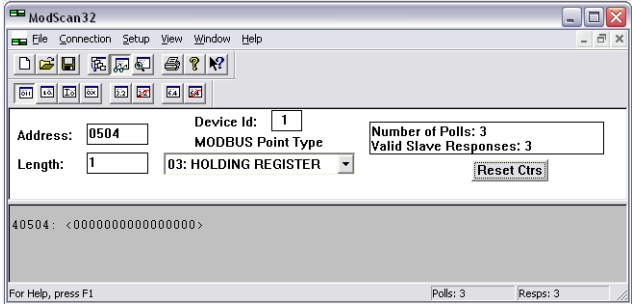

Fig. 341: Modbus - remote control parameter 503

Example 1: Start Request

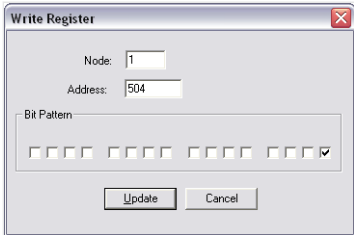

Fig. 342: Modbus - write register - start request

By double-clicking the address, a Write Register command may be issued.

 Fig. 342 shows how bit 0 is set using the ModScan32 Software.

Example 2: Stop Request

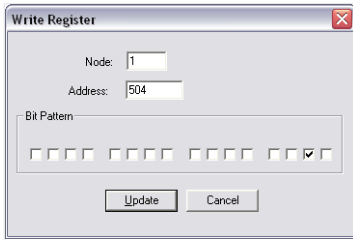

Fig. 343: Modbus - write register - stop request

By double-clicking the address, a Write Register command may be issued.

↳ Fig. 343 shows how bit 1 is set using the ModScan32 Software.

Example 3: External Acknowledge

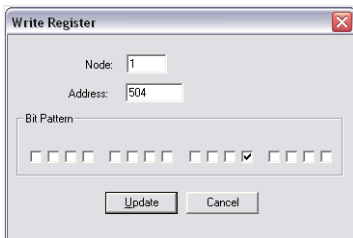

Fig. 344: Modbus - write register - external acknowledge

By double-clicking the address, a Write Register command may be issued.

↳ Fig. 344 shows how bit 4 is set using the ModScan32 Software.

Example 4: Shutdown Command

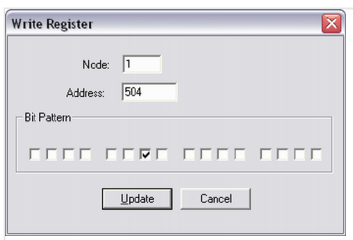

Fig. 345: Modbus - write register - shutdown command

By double-clicking the address, a Write Register command may be issued.

↳ Fig. 345 shows how bit 9 is set using the ModScan32 Software.

Sample for Free alarm 1

This (remote) shutdown request can be taken by LogicsManager equation 12230 to set Flag 1 (see ↳ Fig. 346). To perform an immediately shutdown, the free alarm has to be configured as alarm Class F. Free alarm 1 configuration ↳ Fig. 347 shows how the Monitoring source LM ↳ 8120 »Free alarm 1« is set to Flag 1 and the Alarm class 8121 is set to Class F.

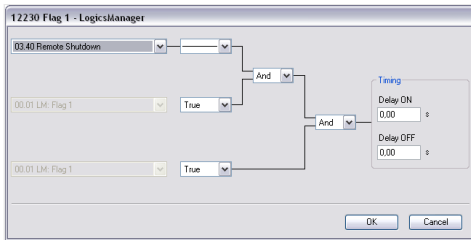

Fig. 346: LM 12230 Flag1

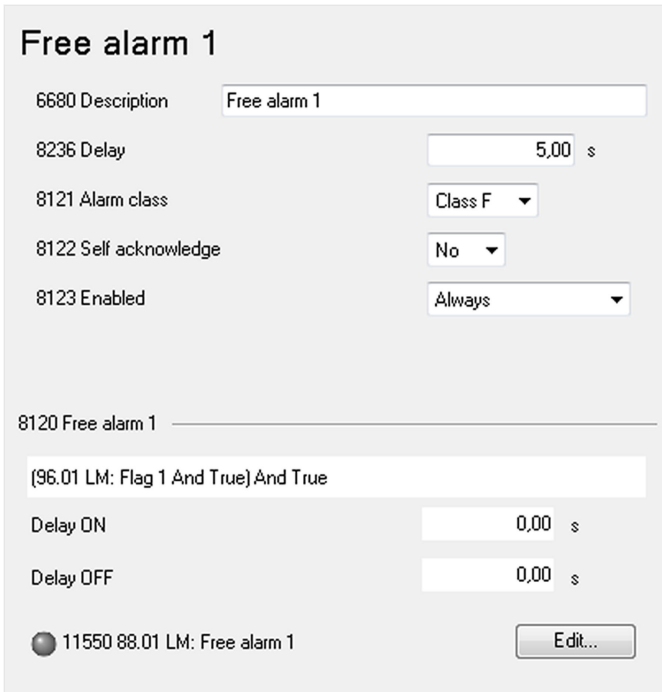

Fig. 347: LM Free-Alarms

6.5.1.2 Setpoint Setting

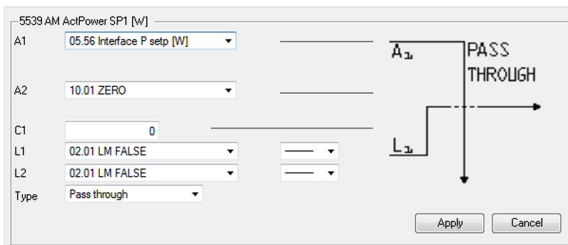



Fig. 348: Setpoint source selection

For a remote setting of the control setpoints, it is necessary to use the interface setpoints instead of the internal setpoints.

For example, use data source "05.56 Interface P setp [kW]" in AnalogManager "AM ActPower SP1 [kW]"  5539 to transmit a load setpoint via interface. No password is required to write this value.

Screen shots beside show an exemplary configuration of the load setpoint 1 source. All other setpoint sources are configured accordingly.

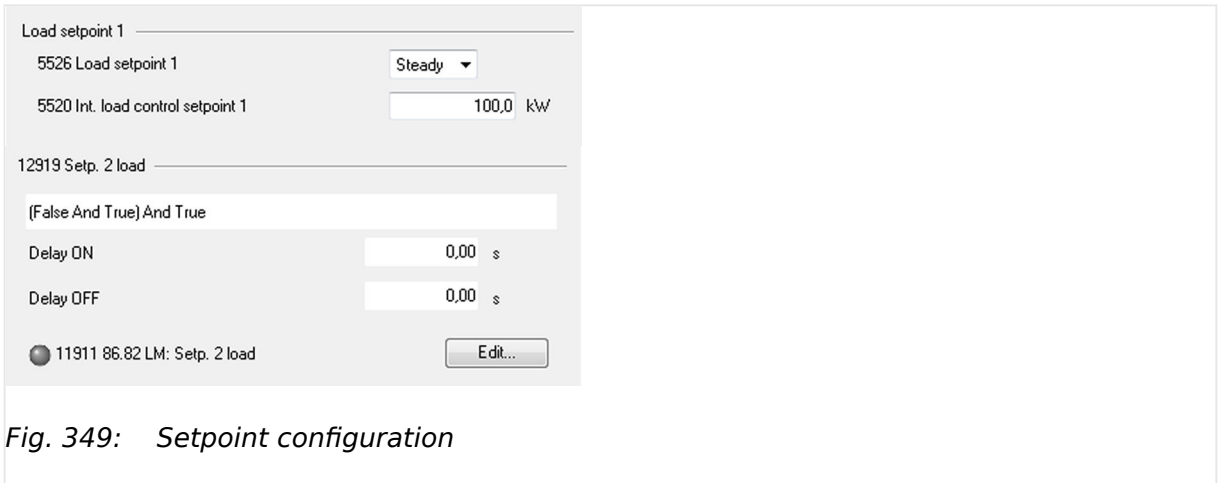

Fig. 349: Setpoint configuration

The interface setpoints may be set using the objects for active power, power factor, frequency, and voltage (refer to [“9.2.9 Additional Data Identifier”](#) for detailed information).

ID	Parameter	Setting range	Unit	Data type	Data source
507	Active Power Setpoint	0 to 999999	1/10 kW	INTEGER 32	05.56 Interface P setp [kW]
508	Power Factor Setpoint	-710 to 1000 to 710	-	INTEGER 16	05.12 Interface PF sp [%]
509	Frequency Setpoint	0 to 7000	1/100 Hz	UNSIGNED 16	05.53 Interface f setp [Hz]
510	Voltage Setpoint	50 to 650000	V	UNSIGNED 32	05.59 Interface v setp [V]

✧ Example 1: Active power interface setpoint

The active power setpoint value must be written to object 21FB (hex), i.e. parameter 507.

A power value of 50 kW = 500 (dec) = 01F4 (hex) is to be transmitted.

- Modbus address = 40000 + (Par. ID + 1) = 40508
- Modbus length = 2 (INTEGER 32)

The high word must be written to the lower address and the low word must be written to the higher address.

⚙

> To set the parameter address in ModScan32:

1. ▷

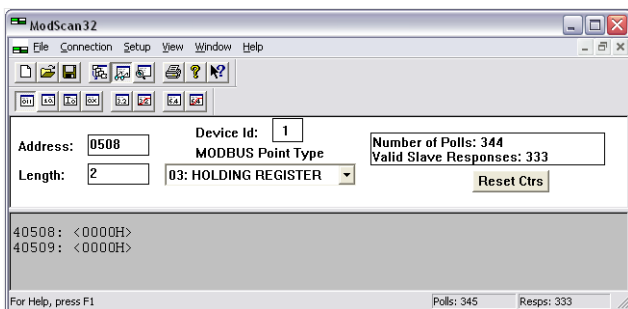

Fig. 350: Modscan32 at address 40508

Open the "Preset Multiple Registers" dialog by selecting [Setup / Extended / Preset Regs] from the menu.

2. ▷

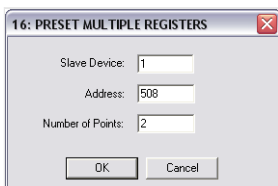

Fig. 351: "Preset Multiple Registers" dialog 1

Select »OK« and enter the desired values.

3. ▷

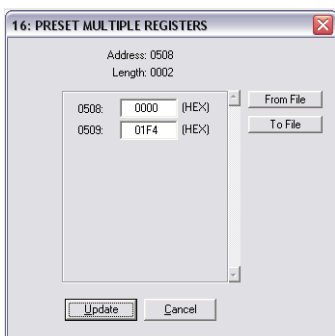

Fig. 352: "Preset Multiple Registers" dialog 2

Select »Update« to confirm the entered values.

▶ The dialog closes and the values are changed.

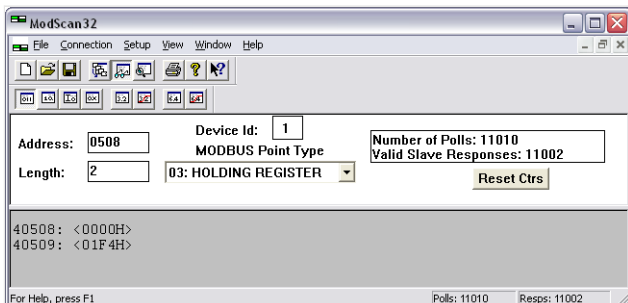

Fig. 353: Modscan32 at address 40508

✧ **Example 2: Power factor interface setpoint**

The power factor setpoint value must be written to object 21FC (hex), i.e. parameter 508.

A power factor of 1 = 1000 (dec) = 03E8 (hex) is to be transmitted.

- Modbus address = 40000 + (Par. ID + 1) = 40509
- Modbus length = 1 (UNSIGNED 16)



> To set the parameter address in ModScan32:

1. ▷

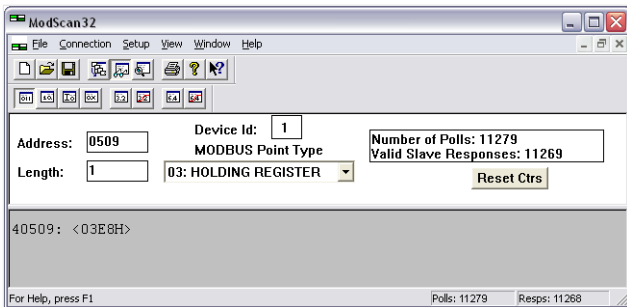

Fig. 354: Modscan32 at address 40509

Analogous to [Chapter 6.5.1.2](#) set the parameter address as shown in [Fig. 354](#).

✧ **Example 3: Frequency interface setpoint**

The frequency setpoint value must be written to object 21FD (hex), i.e. parameter 509. A frequency value of 50.00 Hz = 5000 (dec) = 1388 (hex) is to be transmitted.

- Modbus address = 40000 + (Par. ID + 1) = 40510
- Modbus length = 1 (UNSIGNED 16)



> To set the parameter address in ModScan32:

1. ▷

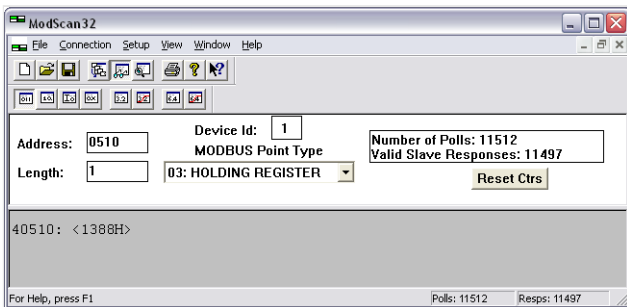

Fig. 355: Modscan32 at address 40510

Analogous to [Chapter 6.5.1.2](#) set the parameter address as shown in [Fig. 355](#).

✧ **Example 4: Voltage interface setpoint**

The voltage setpoint value must be written to object 21FE (hex), i.e. parameter 510. A voltage value of 400 V = 400 (dec) = 0190 (hex) is to be transmitted.

- Modbus address = 40000 + (Par. ID + 1) = 40511
- Modbus length = 2 (UNSIGNED 32)

The high word must be written to the lower address and the low word must be written to the higher address.



> To set the parameter address in ModScan32:

1. ▷

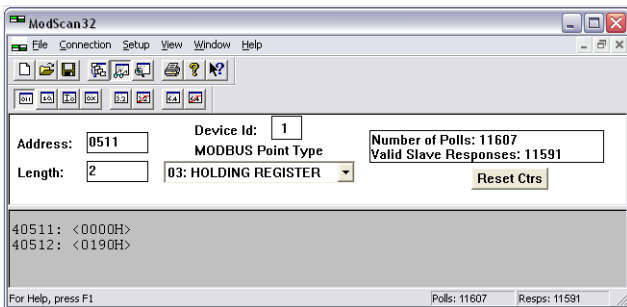

Fig. 356: Modscan32 at address 40511

Analogous to [Chapter 6.5.1.2](#) set the parameter address as shown in [Fig. 356](#).

6.5.1.3 Remotely Changing The Setpoint

It is possible to remotely switch between pre-defined setpoints. This is available for active power, power factor, frequency, and voltage.

The bits 4 to 7 of parameter 504 ([“9.2.9 Additional Data Identifier”](#)) are carrying the settings and are available in CAN bus and Modbus protocols. Each bit may be used as input of the according setpoint switching LogicsManager.

ID	Parameter	Setting range	Data type
504	Remote control word 2	Yes / No	UNSIGNED 16

Table 141: Remote Control word »504«: switching between setpoints

In order to switch to another setpoint, the respective bit of object 21F8 (hex), i.e. parameter 504, must be enabled. The following bits are used for this:

Bit “x” of Parameter 504 remotely requests to switch to	... is available as LogicsManager command variable	... uses LogicsManager “y” to switch
Bit 4	Spannungssollwert 2	"04.37 Remote volt. setp. 2"	12920; "86.83 LM: Setp. 2 voltage"
Bit 5	Frequency setpoint 2	"04.38 Remote freq. setp. 2"	12918; "86.81 LM: Setpoint 2 freq."

Bit "x" of Parameter 504 remotely requests to switch to	... is available as LogicsManager command variable	... uses LogicsManager "y" to switch
Bit 6	Power factor setpoint 2	"04.39 Remote PF setp. 2"	12921: "86.84 LM: Setp.2 pwr.factor"
Bit 7	Active power setpoint 2	"04.40 Remote pwr. setp. 2"	12919; "86.82 LM: Setp. 2 load"
			12998; "87.67 LM: Setp. 3 load"
			12969; "87.75 LM: Setp. 4 load"
			<p>Notes</p> <p>This LogicsManager command variable can be used to switch to each available load setpoint.</p>

Example

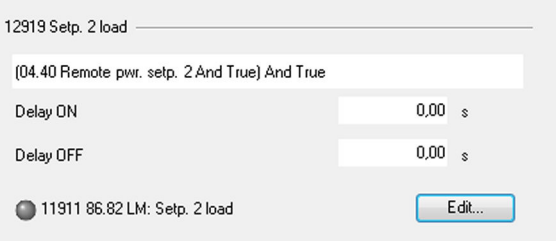

Fig. 357: Remotely switch Setp. 2 load

The active power setpoint 2 is to be enabled. Therefore LM 12919 is prepared using 04.40 (see beside).

The switching signal than comes remotely e.g. as described below:

- Modbus address = 40000 + (Par. ID + 1) = 40505
- Modbus length = 1 (UNSIGNED 16)

To set the bits in ModScan32:

1. ▷

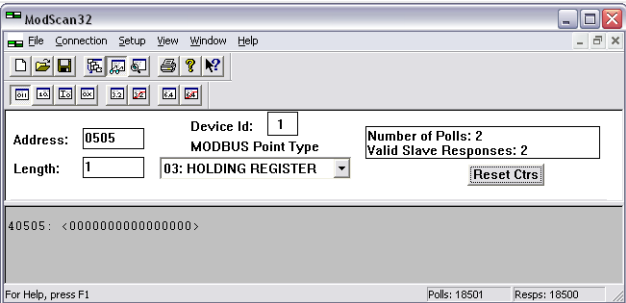

Fig. 358: ModScan32 single bit view

Using the "display options" set the format to binary to view single bits (↪ Fig. 358).

2. ▷

Double-click the address to issue a Write Register command.

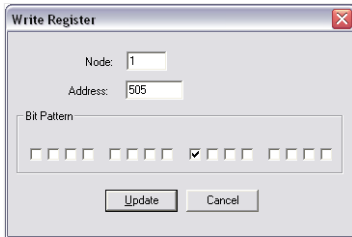

Fig. 359: Active power setpoint

↳ Fig. 359 shows how bit 7 is set to enable the active power setpoint 2.

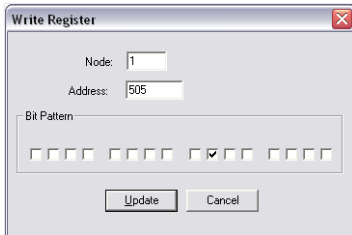

Fig. 360: Power factor setpoint

↳ Fig. 360 shows how bit 6 would be set to enable the power factor setpoint 2.

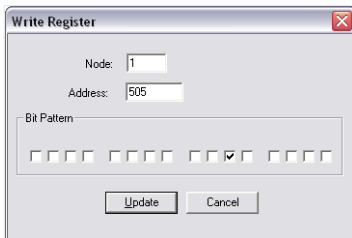

Fig. 361: Frequency setpoint

↳ Fig. 361 shows how bit 5 would be set to enable the frequency setpoint 2.

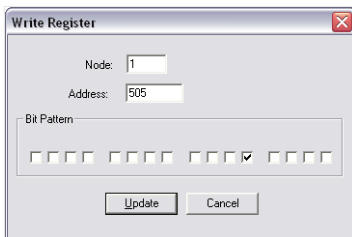

Fig. 362: Voltage setpoint

↳ Fig. 362 shows how bit 4 would be set to enable the voltage setpoint 2.



Additionally/alternatively to remotely changing the control setpoints, it is possible to use "remote" setpoints (values) defined via interface instead of the internal setpoints as data source in the respective controller. For example, use data source "05.53 Interface f setp [Hz]" instead of "05.51 Internal f setp1 [Hz]" in AnalogManager "AM Frequency SP1[Hz]"
↳ 5518 to transmit a frequency setpoint via interface.

6.5.2 Changing Parameter Settings

6.5.2.1 Parameter Setting

i The example tables below are excerpts. Refer to the following chapters for the complete parameter lists:

- [“4.3.4 Enter Password”](#)
- [“4.6 Configure Measurement”](#)

i Be sure to enter the password for the code level that is needed to get access for changing parameter settings via the preferred interface.

i The new entered value must comply with the parameter setting range when changing the parameter setting.

Example 1: Addressing the generator rated voltage

ID	Parameter	Setting range	Data type
1766	Generator rated voltage	50 to 650000 V	UNSIGNED 32

✧

Example

- Modbus address = 40000 + (Par. ID + 1) = 41767
- Modbus length = 2 (UNSIGNED 32)

⚙

1. ▷

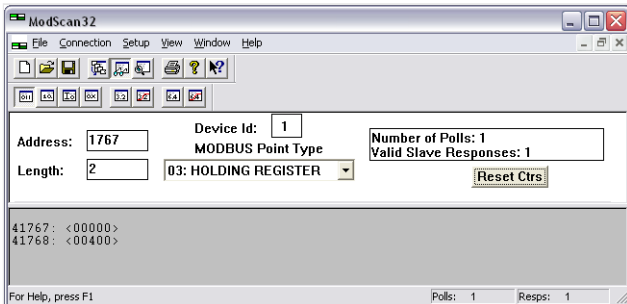
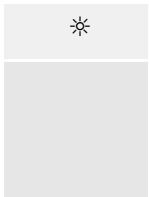

Fig. 363: Modscan32 at address 41767

Set the configuration to address parameter 1766 as shown in [Fig. 363](#).

Example 2: Addressing the generator voltage measuring

ID	Parameter	Setting range	Data type
1851	Generator voltage measuring	3Ph 4W 3Ph 3W 1Ph 2W 1Ph 3W 3Ph 4W OD	UNSIGNED 16



Example

- Modbus address = 40000 + (Par. ID + 1) = 41852
- Modbus length = 1 (UNSIGNED 16)

i If the setting range contains a list of parameter settings like in this example, the parameter settings are numbered and start with 0 for the first parameter setting. The number corresponding with the respective parameter setting must be configured.



1. ▶

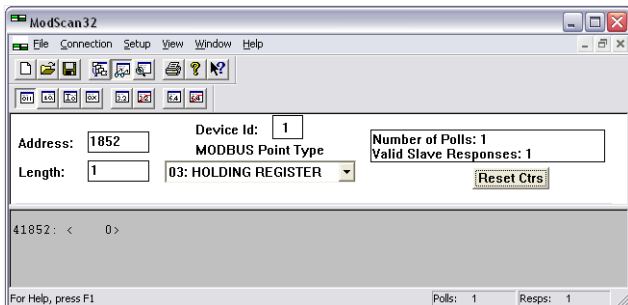

Fig. 364: Modscan32 at address 41852

Set the configuration to address parameter 1851 as shown in (↪ Fig. 364).

- ▶ The parameter is configured to "3Ph 4W".

6.5.2.2 Configuration Of LogicsManager Functions

Next to HMI and ToolKit, LogicsManager can also be configured via Modbus.

- The complete LogicsManager instruction set is available for Modbus control.
- Hex code equivalents are defined for all LogicsManager settings.
- The Modbus definition for a LogicsManager equation consists of 7 data words following a well defined sequence.

Word 0	Word 1	Word 2	Word 3	Word 4	Word 5	Word 6
Delay ON	Delay OFF	Logic equation 1	Logic equation 2	Command 1	Command 2	Command 3

Table 142: 7 words Modbus message

To send a LogicsManager function via Modbus follow these steps:

-  1. ▷ Define your LogicsManager equation
- 2. ▷ Describe the LogicsManager equation as "command chain" in hex code
- 3. ▷ Send the message via Modbus

Describe the LogicsManager equation as "command chain" in hex code (step 2)

The LogicsManager screens below show parts of the command chain. How to generate hex code words is described for each part of the Modbus message.

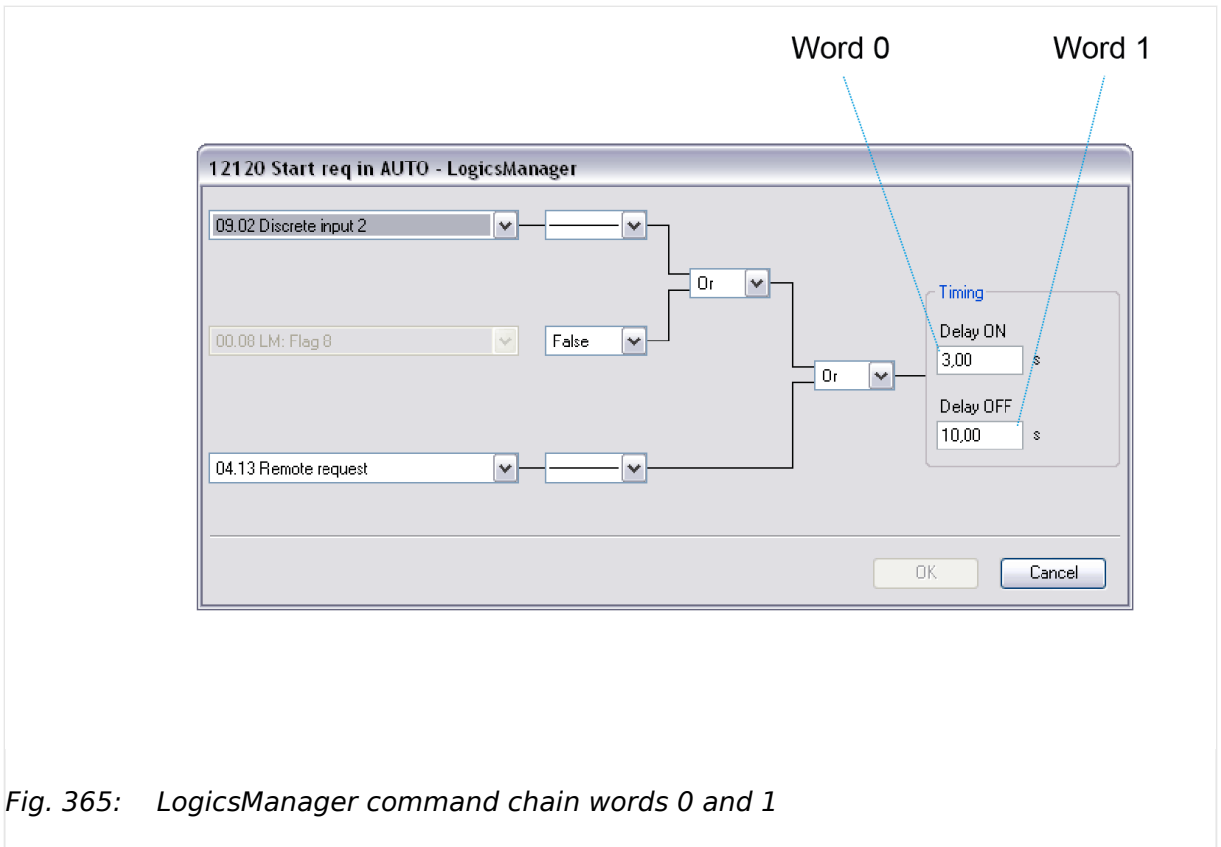

Fig. 365: LogicsManager command chain words 0 and 1

Word 0 and word 1 contain the hex code of the Delay times but in the reverse order of double-byte words, i.e. low byte before high byte.

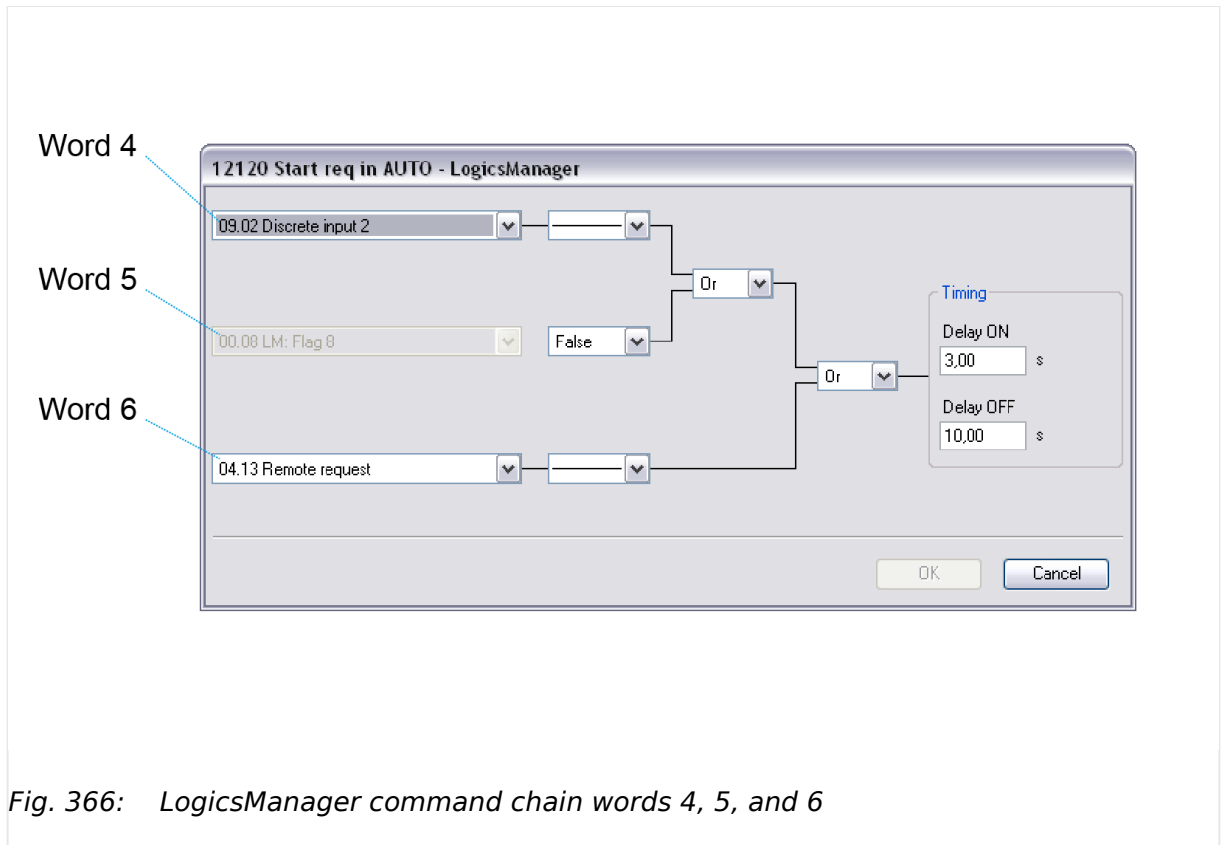

Fig. 366: LogicsManager command chain words 4, 5, and 6

Words 4, 5, and 6 contain the hex codes of the respective command variable ID's decimal value but in the reverse order of double-byte words, i.e. low byte before high byte.



The command variable prefix e.g., "04.13" is the number of the command variable not it's ID.

Refer to [9.3.2 Logical Command Variables](#) for the command variable IDs.

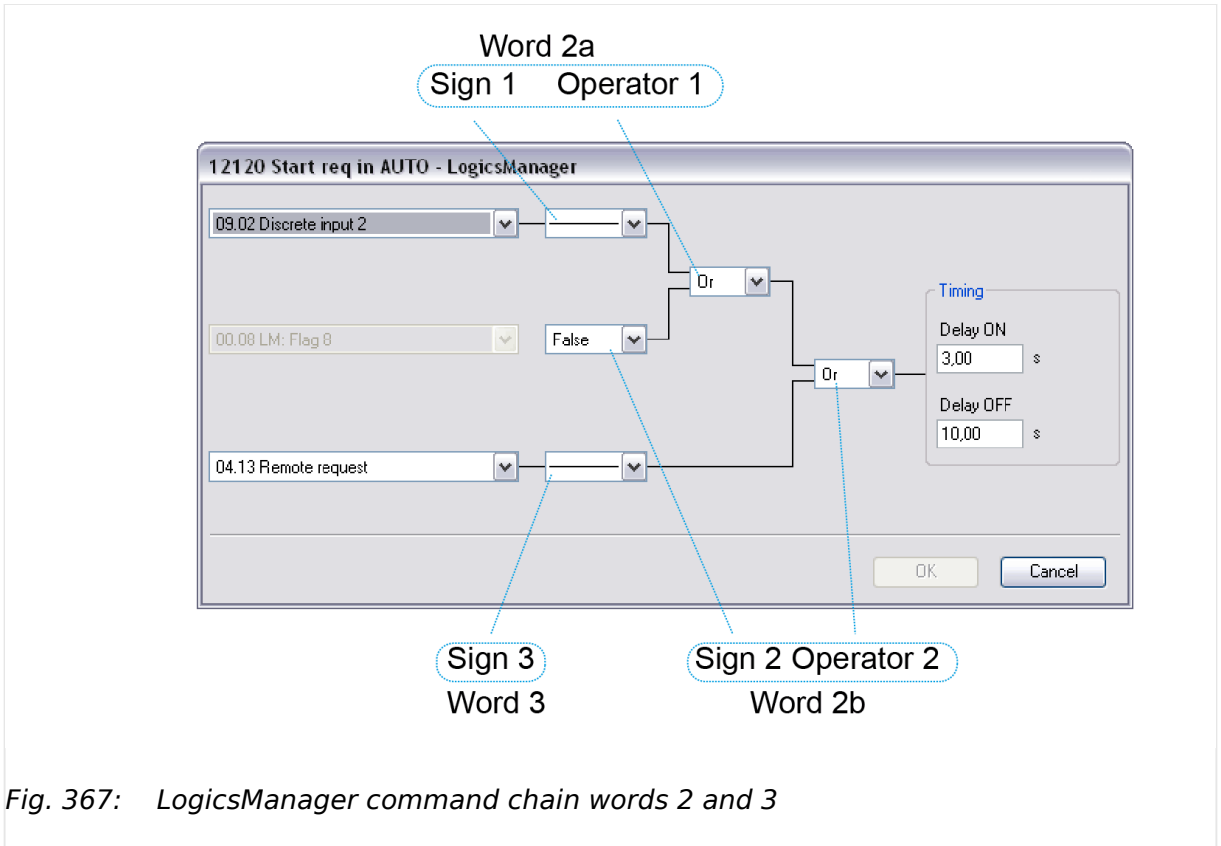

Fig. 367: LogicsManager command chain words 2 and 3

Words 2 and 3 contain a sequence of nibbles each representing a sign or operator of the equation.

The Data words table below shows the sequence how to arrange the LogicsManager setting that build the command chain.

Word 2				Word 3			
Sign 1	Operator 1	Sign 2	Operator 2	Sign 3	not used	not used	not used

Table 143: Data words 2 and 3 - details of the logic equations

Please find the hex code equivalents on the table below:

Signs		Operators	
"NOT"	0	"AND"	0
"_"	1	"NAND"	1
"TRUE"	2	"OR"	2
"FALSE"	3	"NOR"	3
		"XOR"	4
		"NOT-XOR"	5

Table 144: Hex code equivalents of the logic equations' nibbles

The hex code of words 2 and 3 is taken "as is", don't swap high byte and low byte.

Write the Modbus message (step 3)

 It may be necessary to shift the address by 1 depending on the software you use for Modbus communication.

1. ▷

Copy the complete message of 7 words to the address [parameter number +1] in one step.

Word 0		Word 1		Word 2				Word 3			Word 4		Word 5		Word 6		
Delay ON		Delay OFF		Logic equation 1				Logic equation 2			Command 1		Command 2		Command 3		
low byte	high byte	low byte	high byte	Sign 1	Operator 1	Sign 2	Operator 2	Sign 3	0x00	0x00	0x00	low byte	high byte	low byte	high byte	low byte	high byte

Table 145: 7 words Modbus message in detail

Example

The screenshot shows the 'LogicsManager' configuration window for '12120 Start req in AUTO'. It features a logic chain with three discrete input conditions: '09.02 Discrete input 2', '100.08 LM: Flag 8', and '04.13 Remote request'. The first two are connected via an 'Or' operator to a 'False' condition. The 'Remote request' is connected via another 'Or' operator. The timing settings are set to 3.00s for Delay ON and 10.00s for Delay OFF. Callouts identify the following components:

- Word 2a:** Sign 1 (09.02 Discrete input 2)
- Word 2b:** Sign 2 Operator 2 (04.13 Remote request)
- Word 3:** Sign 3 (04.13 Remote request)
- Word 4:** Command 1 (Timing: Delay ON)
- Word 5:** Command 2 (Timing: Delay OFF)
- Word 6:** Command 3 (Timing: Delay OFF)

Fig. 368: LogicsManager command chain sample 12120

Word 0		Word 1		Word 2				Word 3			Word 4		Word 5		Word 6	
Delay ON		Delay OFF		Logic equation 1				Logic equation 2			Command 1		Command 2		Command 3	

Word 0		Word 1		Word 2				Word 3				Word 4		Word 5		Word 6	
3.00 sec		10.00 sec		-	Or	False	Or	-	-/-	-/-	-/-	No. 09.02 ID = 520 dec, 0208 hex		No. 00.08 ID = 7 dec, 0007 hex		No. 04.13 ID = 251 dec, 00FB hex	
low byte	high byte	low byte	high byte	Sign 1	Ope- rator 1	Sign 2	Ope- rator 2	Sign 3	0x00	0x00	0x00	low byte	high byte	low byte	high byte	low byte	high byte
2C	01	E8	03	1	2	3	2	1	0	0	0	08	02	07	00	FB	00

Table 146: 7 words Modbus message sample 12120 in detail

The Modbus message for the LogicsManager equation used for description above is 2C01 / E803 / 1232 / 1000 / 0802 / 0700 / FB00 (hex).

6.5.2.3 Configuration Of LogicsManager Functions For Remote Access

6.5.2.3.1 Basic remote control functions

The following chapters describe how to parametrize the LogicsManager via Modbus for the following basic remote control functions:

- Change to AUTOMATIC mode: 12510 "Operat. mode AUTO"
- Remote request start/stop: 12120 "Start req. in AUTO"
- Remote acknowledge: 12490 "Ext. acknowledge"
- Remote shutdown: 11669 "03.40 Remote Shutdown"
- Start without load: 12540 "Start w/o load"

6.5.2.3.2 Configuration of the LogicsManager "Operation mode AUTO"



To fix the operating mode use the LogicsManager function "86.16 LM: Operat. mode AUTO" (parameter 12510).

The LogicsManager function "Operat. mode AUTO" (parameter 12510) can be configured in two different ways:

- 1. Automatic operating mode is always enabled
- 2. Automatic operating mode is enabled via discrete input



Refer to "6.3.5 Performing Remote Start/Stop And Acknowledgment" for a detailed configuration of the LogicsManager via HMI or ToolKit.

Example

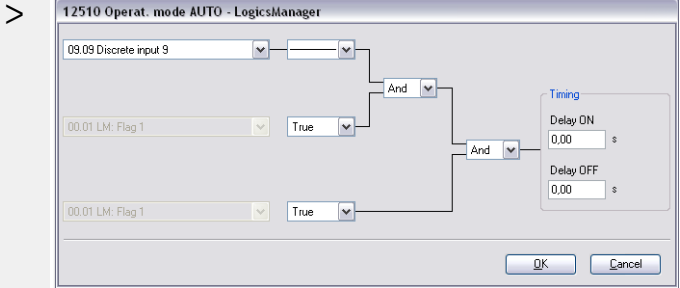

Fig. 369: LogicsManager function sample 12510

To configure the LogicsManager function "Operat. mode AUTO" (parameter \hookrightarrow 12510) as indicated in (\hookrightarrow Fig. 369) the following Modbus message must be sent to the easYgen:

See table \hookrightarrow Table 147 below

* see \hookrightarrow Table 144 for reference

1. \triangleright

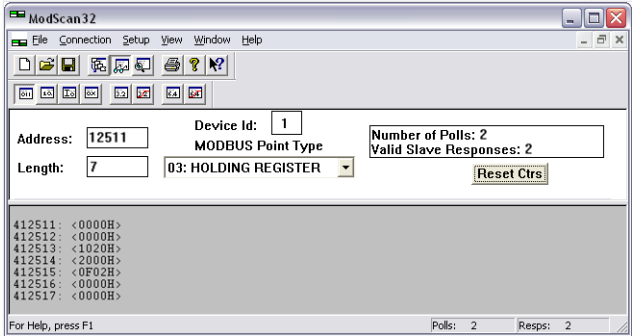



Fig. 370: Modscan32 at address 12511

Copy the complete message of 7 words to address 12511 ff (12510+1) in one step. This is shown in \hookrightarrow Fig. 370 using the ModScan32 software.

Word 0		Word 1		Word 2				Word 3			Word 4		Word 5		Word 6		
Delay ON		Delay OFF		Logic equation 1*				Logic equation 2*			Command 1		Command 2		Command 3		
				Sign 1	Op. 1	Sign 2	Op. 2	Sign 3	-/-	-/-	-/-						
0.00 sec		0.00 sec		-	And	True	And	True	00	00	00	No. 09.09 ID = 527 dec		No. 96.01 ID = 0 dec		No. 96.01 ID = 0 dec	
0000 (hex)		0000 (hex)		1	0	2	0	2	0	0	0	020F (hex)		0000 (hex)		0000 (hex)	
low byte	high byte	low byte	high byte	high byte	low byte	high byte	low byte	high byte	low byte	high byte	low byte	high byte	low byte	high byte	low byte	high byte	

Word 0	Word 1	Word 2	Word 3	Word 4	Word 5	Word 6
0000 (hex)	0000 (hex)	1020 (hex)	2000 (hex)	0F02 (hex)	0000 (hex)	0000 (hex)

Table 147: "Operat. mode AUTO" message



If an shutdown alarm of alarm class C through F occurs in AUTOMATIC operating mode, the control does not return to STOP operating mode if the alarm is cleared after acknowledgment. This means that a restart is initiated.

6.5.2.3.3 Configuration Of Remote Start/Stop, Shutdown, And Acknowledgment



Refer to [6.3.5 Performing Remote Start/Stop And Acknowledgment](#) for a detailed configuration of the LogicsManager via HMI or ToolKit.

The easYgen may start, stop, shut down, or acknowledge alarms with CAN/Modbus. Therefore, two logical command variables (04.13 and 04.14) have to be configured with the LogicsManager. 03.40 can handle Remote shutdown only.

- 04.13 Remote request
- 04.14 Remote acknowledge
- 03.40 Remote Shutdown

6.5.2.3.4 Configuration Of LogicsManager Function "Start Request in AUTO"

The LogicsManager function "Start req. in AUTO" (parameter [12120](#)) can be configured in a way that a start request in AUTOMATIC operating mode is enabled as soon as a remote request is issued.

Refer to [6.3.5 Performing Remote Start/Stop And Acknowledgment](#) for a detailed configuration of the LogicsManager via HMI or ToolKit.

The remote request may be enabled by setting bit 0 (start) of the remote control word 503 to HIGH and may be disabled by setting bit 1 (stop) of the remote control word 503 to HIGH (refer to [9.2.9 Additional Data Identifier](#)).

Example



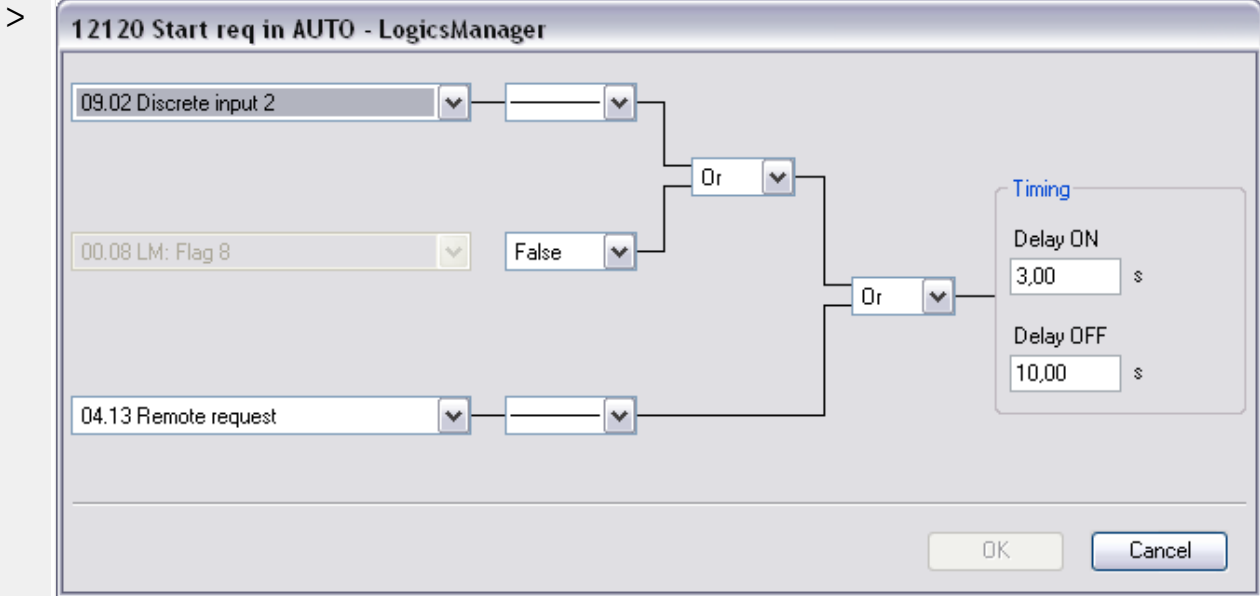

Fig. 371: LogicsManager function sample 12120

To configure the LogicsManager function "Start req. in AUTO " (parameter 12120) as indicated in (Fig. 371) the following Modbus message must be sent to the easYgen: See table Table 148 below.

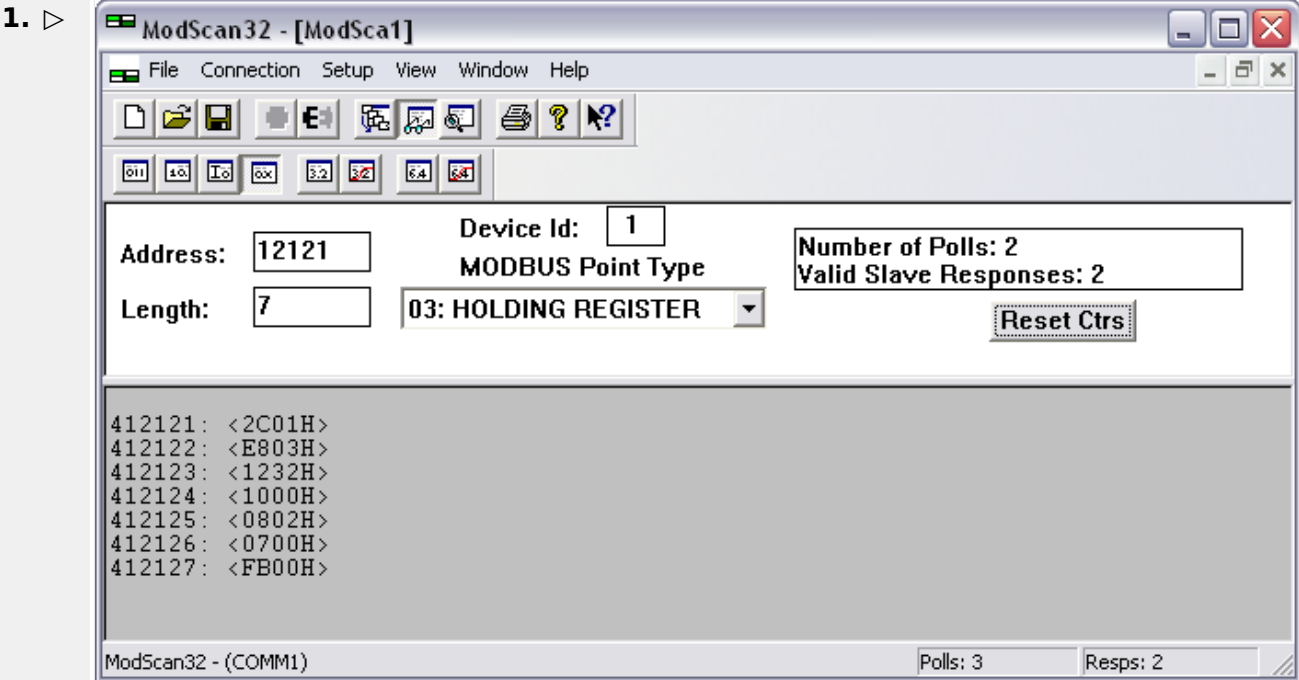

Fig. 372: Modscan32 at address 12121

Copy the complete message of 7 words to address 12121 ff (12120+1) in one step. This is shown in (Fig. 372) using the ModScan32 software.

Word	Word 1	Word 2	Word 3	Word 4	Word 5	Word 6
0						
Delay ON	Delay OFF	Logic equation 1*	Logic equation 2*	Command 1	Command 2	Command 3

Word 0	Word 1	Word 2				Word 3				Word 4	Word 5	Word 6	
		Sign 1	Op. 1	Sign 2	Op. 2	Sign 3	-/-	-/-	-/-				
3.00 sec	10.00 sec	-	Or	False	Or	-	00	00	00	No. 09.02 ID = 520 dec	No. 96.08 ID = 7 dec	No. 04.13 ID = 251 dec	
012c (hex)	03E8 (hex)	1	2	3	2	1	0	0	0	0208 (hex)	0007 (hex)	00FB (hex)	
low byte	high byte	low byte	high byte	high byte	low byte	high byte	low byte	high byte	low byte	low byte	high byte	low byte	high byte
2C01 (hex)	E803 (hex)	1232 (hex)				1000 (hex)				0802 (hex)	0700 (hex)	FB00 (hex)	

Table 148: Start req. in AUTO message

6.5.2.3.5 Configuration Of LogicsManager Function "External Acknowledge"

The LogicsManager function "Ext. acknowledge" (parameter [↩ 12490](#)) can be configured in a way that an external acknowledgment is performed as soon as the remote acknowledge signal is enabled.

Refer to [↩ "6.3.5 Performing Remote Start/Stop And Acknowledgment"](#) for a detailed configuration of the LogicsManager via HMI or ToolKit.

External acknowledge may be enabled by setting bit 4 (external acknowledge) of the remote control word 503 to HIGH (refer to [↩ "9.2.9 Additional Data Identifier"](#)).

Example

>

Fig. 373: LogicsManager function sample 12490

To configure the LogicsManager function "Ext. acknowledge" (parameter [↩ 12490](#)) as indicated in ([↩ Fig. 373](#)) the following Modbus message must be sent to the easYgen: See table [↩ Table 149](#) below.

1. ▷

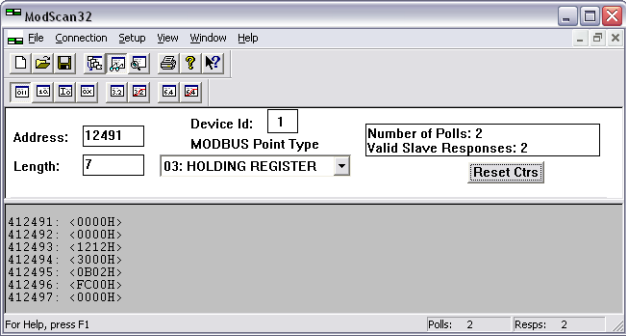

Fig. 374: Modscan32 at address 12491

Copy the complete message of 7 words to address 12491 ff (12490+1) in one step. This is shown in Fig. 374 using the ModScan32 software.

Word 0		Word 1		Word 2				Word 3				Word 4		Word 5		Word 6	
Delay ON		Delay OFF		Logic equation 1*				Logic equation 2*				Command 1		Command 2		Command 3	
				Sign 1	Op. 1	Sign 2	Op. 2	Sign 3	-/-	-/-	-/-						
0.00 sec		0.00 sec		-	Or	-	Or	False	00	00	00	No. 09.05 ID = 523 dec		No. 04.14 ID = 252 dec		No. 96.01 ID = 0 dec	
0000 (hex)		0000 (hex)		1	2	1	2	3	0	0	0	020B (hex)		00FC (hex)		0000 (hex)	
low byte	high byte	low byte	high byte	high byte	low byte	high byte	low byte	high byte	low byte	high byte	low byte	high byte	low byte	high byte	low byte	high byte	
0000 (hex)		0000 (hex)		1212 (hex)				3000 (hex)				0B02 (hex)		FC00 (hex)		0000 (hex)	

Table 149: "Ext. acknowledge" message

6.5.2.3.6 Configuration Of LogicsManager Function "Start w/o load"

The Start w/o load LogicsManager function (parameter 12540) can be configured in a way that it is always enabled.

Refer to "6.3.5 Performing Remote Start/Stop And Acknowledgment" for a detailed configuration of the LogicsManager via HMI or ToolKit.

Example



6 Application Field

6.5.2.3.6 Configuration Of LogicsManager Function "Start w/o load"

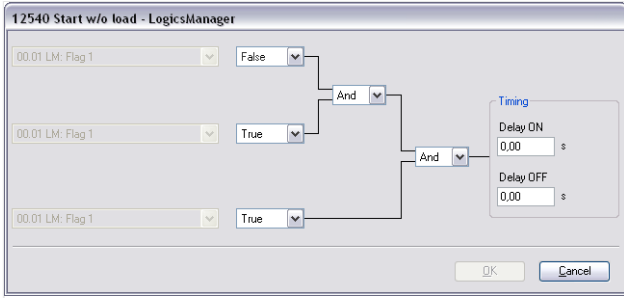

Fig. 375: LogicsManager function sample 12540

To configure the LogicsManager function "Start w/o load" (parameter ID 12540) as indicated in Fig. 375 the following Modbus message must be sent to the easYgen: See table Table 150 below.

1. ▷

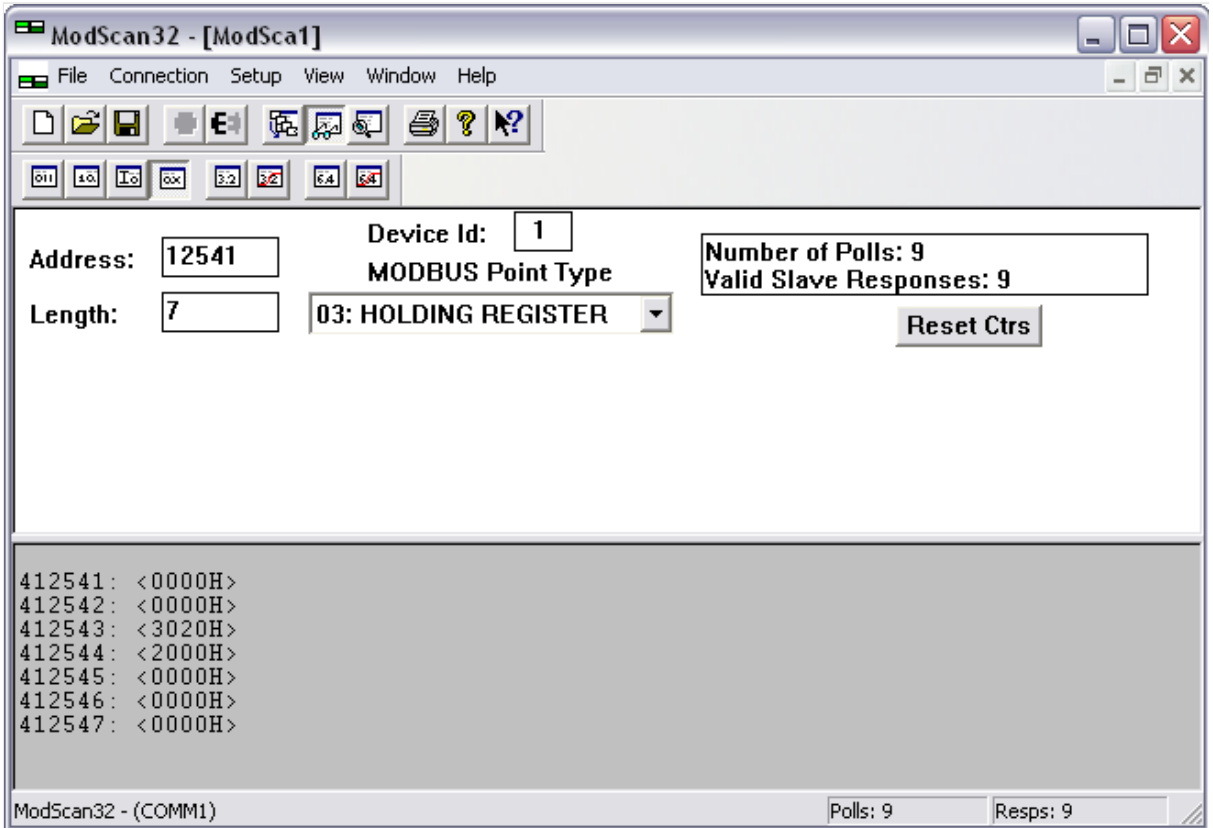

Fig. 376: Modscan32 at address 12541

Copy the complete message of 7 words to address 12541 ff (12540+1) in one step. This is shown in Fig. 376 using the ModScan32 software.

Word 0	Word 1	Word 2				Word 3				Word 4	Word 5	Word 6
Delay ON	Delay OFF	Logic equation 1*				Logic equation 2*				Command 1	Command 2	Command 3
		Sign 1	Op. 1	Sign 2	Op. 2	Sign 3	-/-	-/-	-/-			
0.00 sec	0.00 sec	False	And	True	And	True	00	00	00	No. 00.01 ID =	No. 96.01 ID =	No. 96.01 ID =
										0 dec	0 dec	0 dec
0000 (hex)	0000 (hex)	3	0	2	0	2	0	0	0	0000 (hex)	0000 (hex)	0000 (hex)

Word 0		Word 1		Word 2				Word 3				Word 4		Word 5		Word 6	
low byte	high byte	low byte	high byte	high byte	low byte	high byte	low byte	high byte	low byte	high byte	low byte	low byte	high byte	low byte	high byte	low byte	high byte
0000 (hex)		0000 (hex)		3020 (hex)				2000 (hex)				0000 (hex)		0000 (hex)		0000 (hex)	

Table 150: "Start w/o Load" message

6.5.2.4 Remotely Acknowledge Single Alarm Messages

Single alarm messages can be acknowledged remotely through the Modbus by sending the respective parameter ID of the alarm to be acknowledged on parameter 522. The required procedure is detailed in the following steps.

ID	Parameter	Setting range	Data type
522	Reset alarm list	0 to 65535	UNSIGNED 16

The parameter ID of the alarm to be acknowledged must be written to object 220A (hex), i.e. parameter 522.

Example

A "Mains undervoltage 1" alarm (ID 3012) shall be acknowledged (refer to ["9.5.5 Alarm Messages"](#)).

- Modbus address = 40000 + (Par. ID + 1) = 40523
- Modbus length = 1 (UNSIGNED 16)

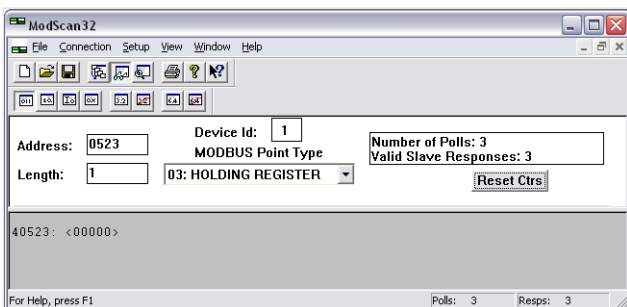

Fig. 377: ModScan32 at address 40523

1. ▷ Use the "display options" to set the format to decimal view.
2. ▷ Double-click the address to issue a Write Register command.



Fig. 378: Write register - acknowledge alarm message

↳ Fig. 378 shows how the parameter ID of the alarm to be acknowledged is written using the ModScan32 Software.

6.5.2.5 Remotely Clearing The Event History

The event history can be cleared remotely through the Modbus. The required procedure is detailed in the following steps.

ID	Parameter	Setting range	Data type
1706	Clear eventlog	Yes / No	UNSIGNED 16

In order to clear the event history, bit 0 of object 26AA (hex), i.e. parameter 1706, must be enabled.

* Remotely clearing event history

- Modbus address = 40000 + (Par. ID + 1) = 41707
- Modbus length = 1 (UNSIGNED 16)

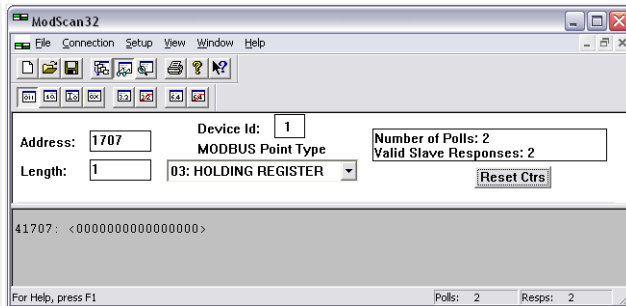

Fig. 379: Modscan32 at address 41707

1. ▷ Use the "display options" to set the value format to binary.
2. ▷ Double-click the address to issue a Write Register command.

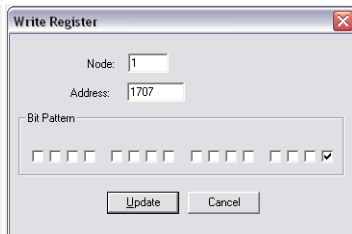

Fig. 380: Write register - clear event history

↳ Fig. 380 shows how bit 0 is enabled using the ModScan32 Software.

6.5.2.6 Remotely Resetting The Default Values

6.5.2.6.1 Modbus

ID	Parameter	Setting range	Data type
10417	Factory default settings	Yes / No	UNSIGNED 16
1701	Set factory default values	Yes / No	UNSIGNED 16

In order to enable the resetting procedure, parameter 10417 must be enabled.

Example 1 (enable resetting)

The resetting procedure shall be enabled.

- Modbus address = 40000 + (Par. ID + 1) = 410418
- Modbus length = 1 (UNSIGNED 16)

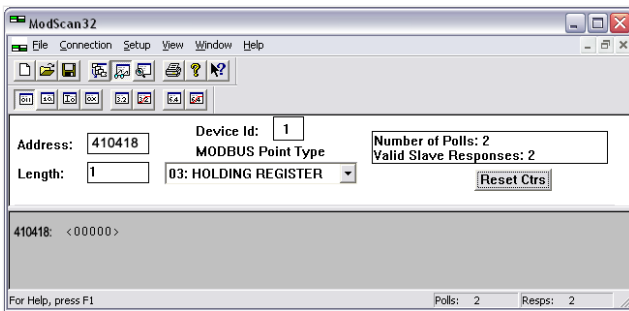

Fig. 381: Modscan32 at address 410418

1. ▷ Use the "display options" to set the value format to decimal.
2. ▷ Double-click the address to issue a Write Register command.



Fig. 382: Write register - enable the resetting procedure

↳ Fig. 382 shows how the parameter is enabled using the ModScan32 Software. The value must be set to "1" to enable the parameter.

Example 2 (reset to default)

In order to reset the default values, parameter [1701](#) must be enabled.

CAUTION!



Set factory default settings causes easYgen power cycle!

Don't run "Set factory default values" \hookrightarrow 1701 during controlling a genset because it causes a power cycle of the easYgen control.

The default values shall be reset.

- Modbus address = 40000 + (Par. ID + 1) = 41702
- Modbus length = 1 (UNSIGNED 16)

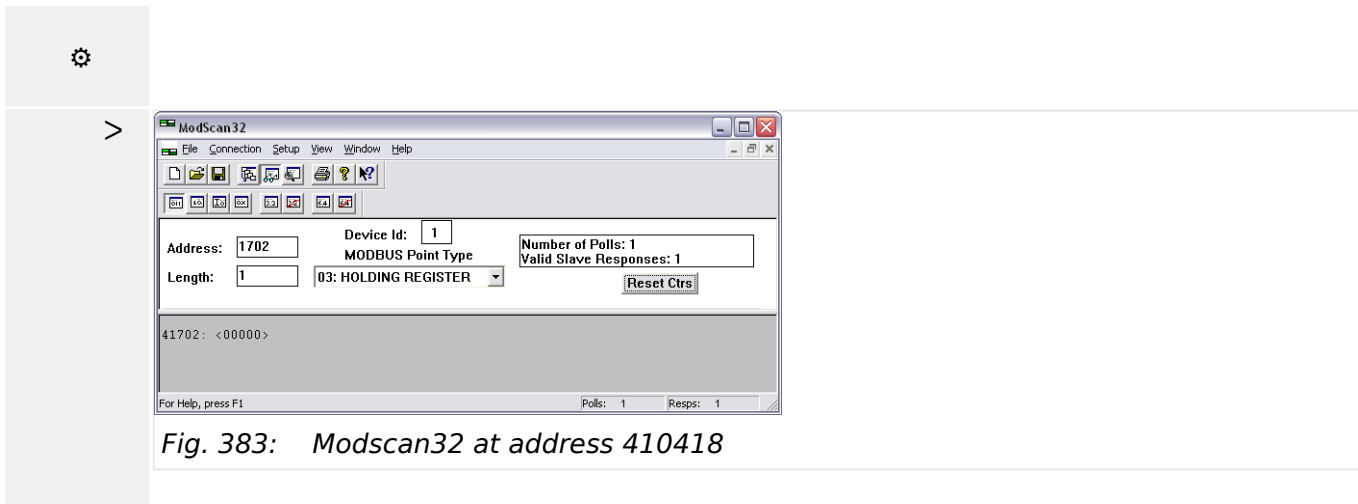

Fig. 383: Modscan32 at address 410418

1. ▷ Use the "display options" to set the value format to decimal.
2. ▷ Double-click the address to issue a Write Register command.



Fig. 384: Write register - resetting the default values

\hookrightarrow Fig. 384 shows how the parameter is enabled using the ModScan32 Software. The value must be set to "1" to enable the parameter.

6.5.3 Exception Responses

The Modbus protocol has multiple exception responses to show that a request could not be executed. Exception responses can be recognized if the response telegram contains the request function code with an offset of 128 (0x80 hex).

\hookrightarrow Table 151 explains possible reasons for an exception response that occurred.

Modbus exception responses		
Code	Name	Reason
01	ILLEGAL FUNCTION	The sent request function code is not supported by the Modbus protocol.
02	ILLEGAL ADDRESS	Permission to read/write the parameter is denied. The amount of requested registers is wrong to read/write this registers.
03	ILLEGAL DATA VALUE	The data value exceeds the min. and max. limitations of the parameter upon a write request. There is no parameter on the requested address.

Table 151: Modbus - exception responses

6.5.4 Modbus Telegram Mapper (Customer Written Data Protocols)

6.5.4.1 Introduction

The Modbus Telegram Mapper offers the possibility to generate customer defined Modbus protocols. It is possible to create individual Modbus Address Point lists for Modbus RTU and TCP. Therefore the address range (4)50000 can be taken. The user will be able to arrange contents from the easYgen database (Index No.), AnalogManager Variables and LogicsManager Command Variables to a customer specific protocol.

6.5.4.2 Configuration

Woodward offers the TelegramMapper PC software for free and enables easYgen-XT to import, make accessible, and proceed customer specific Modbus protocols. The TelegramMapper software can be installed separately from other Woodward software.



The Woodward Telegram Mapper software is required. To obtain this software you can either go over \Rightarrow <https://www.woodward.com> where you navigate to Industrial / Technical Help Desk / Software LOOKUP / ...and typing telegram mapper into the search window.

or

you can download it from internet you can download it from internet \Rightarrow https://wss.woodward.com/manuals/PGC/easYgen-3000XT_series/SW_Tools/TelegramMapper

After starting the program the HELP file can guide through the required settings.

Data of the particular easYgen model will be available/selectable:



- AnalogManager variables
- LogicsManager variables
- the easYgen database (ID based)

The according data types must be defined and each address entry can be commented. There is a maximum length of 300 addresses.

The final protocol can be saved with a **protocol number from 65100 to 65199 used as file name(!)** as an

- SCP-file for import into the easYgen device
- HTML-file for easy to read documentation of the (self) created data protocol
- MAP-file for further edits with the TelegramMapper software

To load your created Data Protocol(s) - the scp-file(s) - into your easYgen device use ToolKit.

To switch to your Data Protocol and use it for communication: Configure parameter  3184 "Modbus protocol number" to your customer specific protocol number and reboot  10419 the control.

Summary: The self-mappable address range is defined with a protocol number from 65100 to 65199 and has a maximum length of 300 addresses. Communication using customer specific data protocols is configurable similar to other already existing protocols 5003, 5011 etc. Navigate to [Parameter / Configuration / Configure interfaces / Modbus protocol].



The Telegram Mapper will ask for loading a package zip software. Each easYgen type and revision has an own multilingual_package zip software. To obtain this software you can either go over  <https://www.woodward.com> where you navigate to Industrial / Technical Help Desk / Control Configuration Files

or

you can download it from internet you can download it from internet  https://wss.woodward.com/manuals/PGC/easYgen-3000XT_series

- Navigate to your model
- Navigate to 02_Config_Files_
- Navigate to your part number and revision
- Download XXXX-XXXX_Y_multilingual_package
- Store it into your project folder

6.5.4.3 Status/diagnostic Modbus Telegram Mapper

The easYgen provides an information whether the Modbus TelegramMapper mapping file could be successful parsed and interpreted. Navigate to [STATUS MENU / Interfaces / >Ethernet / Modbus TCP/IP] to get an error code.

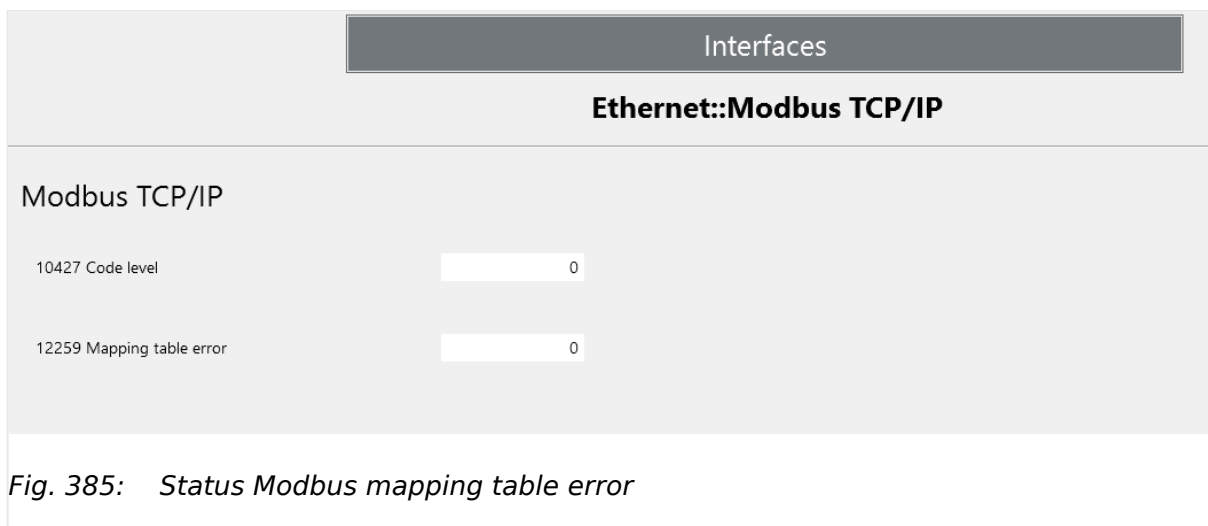

Fig. 385: Status Modbus mapping table error

Modbus: Mapping table error (12259):

Error codes:

- **0:** No error
- **100000 + error line:** There is a syntax error -- for any misformatted line
- **200000:** File not found -- when file corresponding to selected protocol does not exist
- **300000:** Too complex command discovered
- **700000:** Too many analog/logic manager indices (i.e. > 32)
- **800000:** Memory for the table exhausted (file too big)

6.5.5 Modbus master

6.5.5.1 Introduction

The device can act as a configurable Modbus master, for Modbus/TCP. Up to 5 independent slaves can be accessed simultaneously.

Note: For the configuration the licensed ModbusMasterMapper PC software is required.



The Modbus Master does not work with the serial interface (RS-485, Modbus RTU).

Up to 99 analog values can be read and transferred into **AnalogManager group 54** ("54.01 Mapped AM value 1" to "54.99 Mapped AM value 99") and up to 99 boolean values can be read and transferred into **LogicsManager group 54** ("54.01 Mapped LM flag 1" to "54.99 Mapped LM flag 99").

All analog values which are present in the device as AnalogManager values and all flags which are present as LogicsManager values can be written. Boolean flags can be grouped into 16 bit values. Reading and writing each can be combined to read/write multiple values in one command. Different variable types and Modbus modes are supported.

Multiple write and read rates can be defined, in order to access some datapoints more often than others.

6.5.5.2 Configuration with MasterMapper Tool

Woodward offers a ModbusMasterMapper PC software to configure the Modbus Master behavior for free and enables the device to import, make accessible, and proceed customer specific settings. The ModbusMasterMapper software can be installed separately from other Woodward software.



Woodwards MasterMapper Tool software is required. To obtain this software you can either go over \Rightarrow <https://www.woodward.com> where you navigate to Industrial / Technical Help Desk / Software LOOKUP / ...and typing master mapper into the search window.

or

you can download it from internet \Rightarrow https://wss.woodward.com/manuals/PGC/easYgen-3000XT_series/SW_Tools/MasterMapper

After starting the program the HELP file can guide through the required settings.

Data of the particular device will be available/selectable:

- AnalogManager variables
- LogicsManager variables
- the database (ID based)

The according data types, addresses, rates must be defined and each read/write entry can be commented.

Note: Modbus master has for read and write a limitation of maximum about 120 words. The ModbusMasterMapper PC software detects an overrun and will issue a warning.

The final protocol can be saved as a mapping file (*.mmap) file for further processing. The tool creates a *. SCP-file for uploading the Modbus Master control file into the device using Toolkit. After uploading and restarting the Modbus Master process can be started via configuring parameter 3219 to "On". Now the configured communication will be executed.



The MasterMapper will ask for loading a package zip software. Each easYgen type and revision has an own multilingual_package zip software. To obtain this software you can either go over \Rightarrow <https://www.woodward.com> where you navigate to Industrial / Technical Help Desk / Control Configuration Files

or

you can download it from internet you can download it from internet \Rightarrow https://wss.woodward.com/manuals/PGC/easYgen-3000XT_series/SW_Tools/ModbusMasterMapper

- Navigate to your model
- Navigate to 02_Config_Files_
- Navigate to your part number and revision
- Download XXXX-XXXX_Y_multilingual_package
- Store it into your project folder

ID	Parameter	CL	Setting range [Default]	Description
3219	Modbus master	2	[Off]	The Modbus master function is disabled and no Modbus master requests are sent.
			On	The Modbus master function is requesting data according to the control file. Note Take care that a Modbus master control file is already load into the device.



For more details refer to the help documentation of the ModbusMasterMapper PC software.

6.5.5.3 Status/diagnostic Modbus master

Toolkit is providing a screen for some Modbus master diagnostics.

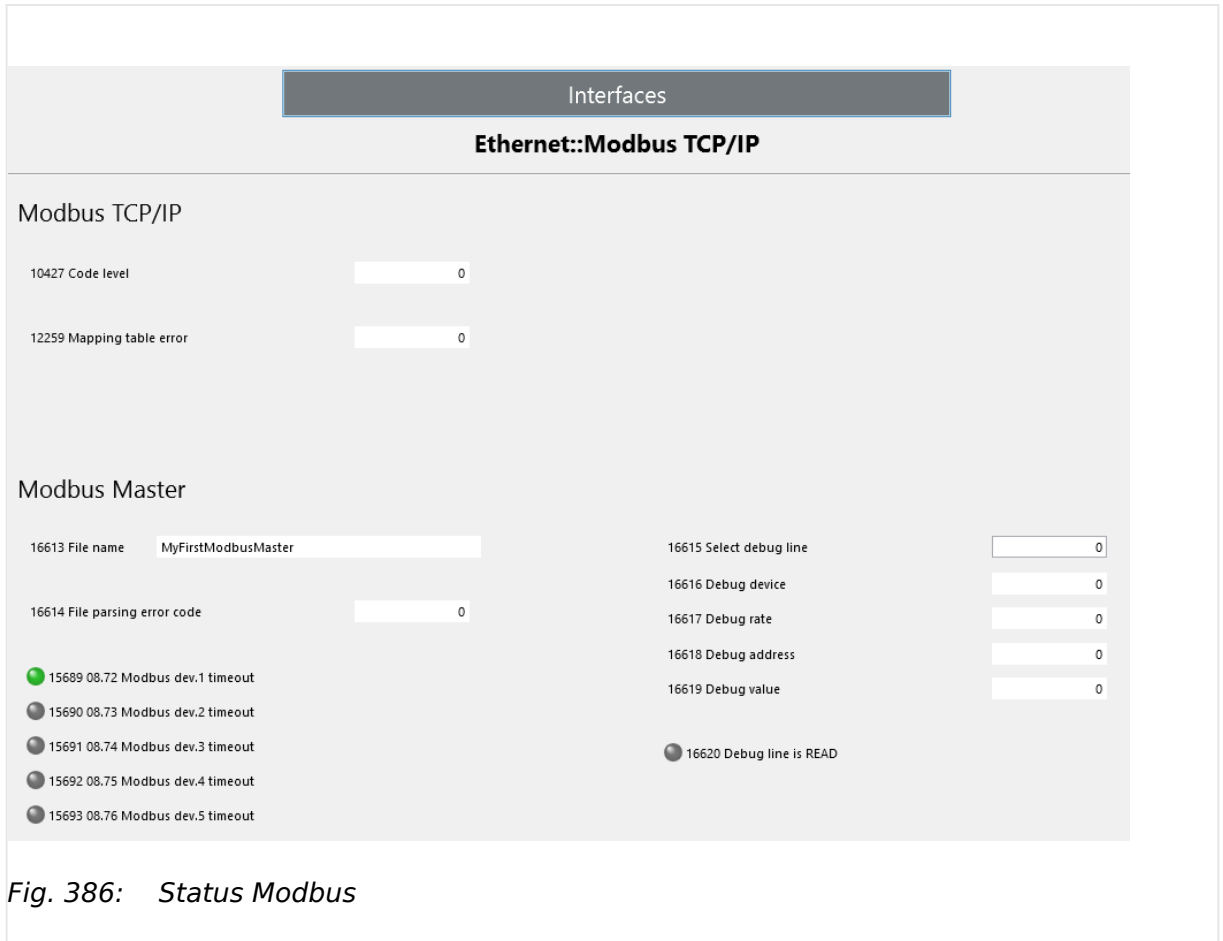

Fig. 386: Status Modbus

File name (16613):

This field shows the "Description" from the loaded Modbus Master config file. This will be read in at start-up.

File parsing error code (16614):

File parsing error code (16614)	
Code	Meaning
0	No error
1	File error: File was not found or could not be opened
2	Not a mapping file: The file is not a Modbus master mapping file or a malformed one.
4	Wrong version of mapping file: The version of the mapping file does not match. This can appear when the file was generated by an older version of the PC tool.
8	Mapping file has wrong check-sum: The mapping file was corrupted and is invalid. It has to be newly created.
16	Wrong SIZES statement: This is an internal file error, this shall not happen when the file was correctly created by the PC tool.
32	APPLICATION line wrong in file. The file was created for an application which does not match to the application running on the device. It has to be newly created for this application.

File parsing error code (16614)	
Code	Meaning
64	RELEASE line wrong in file. The file was created for a software release which does not match to the application running on the device. It has to be newly created for this release.

"Select debug line"(16615):

This "parameter" activates a debug mode when a number is entered higher than 0. This function enables the user to test the connections to different devices separately.

Valid values are:

- 0: Debug mode off (default)
- 1000+x: WRITE line 1000+x will be executed
- 2000+x: READ line 2000+x will be executed

Only the selected WRITE or READ line of the mapping file will be executed. All other reads and writes are suppressed.

"Select debug line" (16615)	
Indication	Meaning
16616 Debug device	This output shows the device number [1..] as defined in the mapping file of the selected debug line command. It is 0, if "Select debug line" set to 0.
16617 Debug rate	This output shows the rate in [s] of the selected debug line command. It is 0, if "Select debug line" set to 0.
16618 Debug address	This output shows the Modbus address of the selected debug line command. It is 0, if "Select debug line" set to 0.
16619 Debug value	This output shows the read or wrote value for the selected Debug line command. When multiple read or multiple write was selected, it shows the first value. It is 0, if "Select debug line" set to 0.
16620 Debug line is READ	This output is TRUE (LED is green), if the selected Debug line command was a read, otherwise FALSE. It is FALSE too if "Select debug line" set to 0.

Modbus Slave Devices 1-5 timeouts:

The LED s of LM variables "08.72 Modbus dev.1 timeout" to "08.76 Modbus dev.5 timeout" inform about time outs of the corresponding slave devices.

Timeouts can happen e.g. in this cases:

- The slave is not answering at all
- The slave is answering but in a rate slower than defined in the mapping file. This can happen, when the slave is inherently slow or when the mapping was set up in a way that too many requests were scheduled in the scheduled rate time.

6 Application Field

6.5.5.3 Status/diagnostic Modbus master

One Modbus read or write command to one slave will take at least 50 msec. The minimum permitted rate group is 100 msec. If now a mapping is configured in a way that it requires more writes to a device than fits into the required rate, or the slave has very long answer times, there will be a timeout error. The device will still read/write but it will not do it as quickly as required. This issue can be mitigated by defining slower rate groups or reducing the number of read/write commands.

7 Interfaces And Protocols



For interfaces terminal overview refer to [“3.4 Setup Interfaces”](#)

7.1 CAN Interfaces

7.1.1 CAN Interface 1 (Guidance level)

The CAN interface 1 is a freely configurable CANopen interface with 5 RPDOs (receive messages), 5 TPDOs (send messages) and 4 additional Server SDOs.

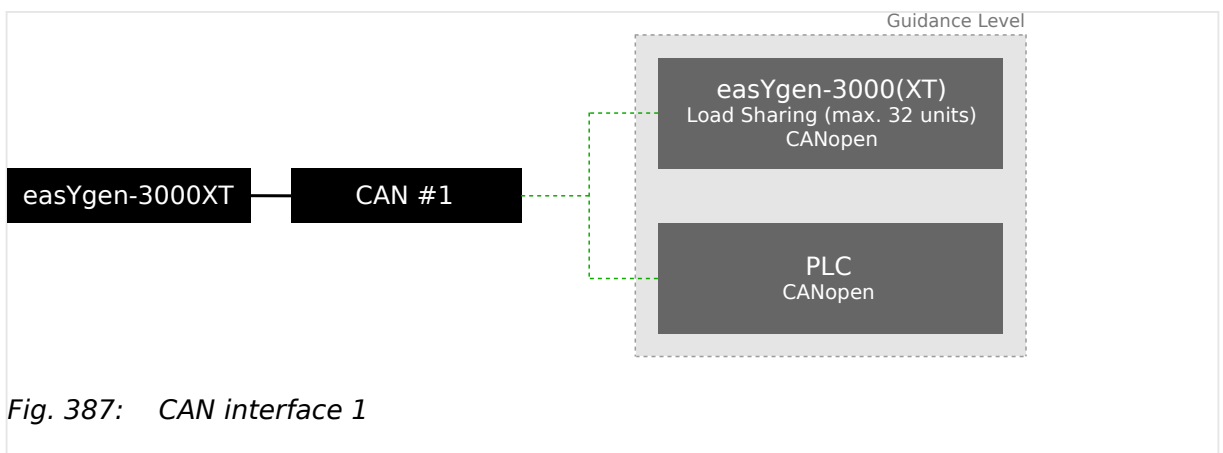

Fig. 387: CAN interface 1

7.1.2 CAN Interface 2 (Engine level)

The CAN interface 2 supports the CANopen and J1939 protocol simultaneously. It supports the connection of a wide range of engine control units (ECUs) and J1939 analog input extension modules, which comply with the J1939 standard (e.g. Axiomatic). CANopen extension modules are also supported.

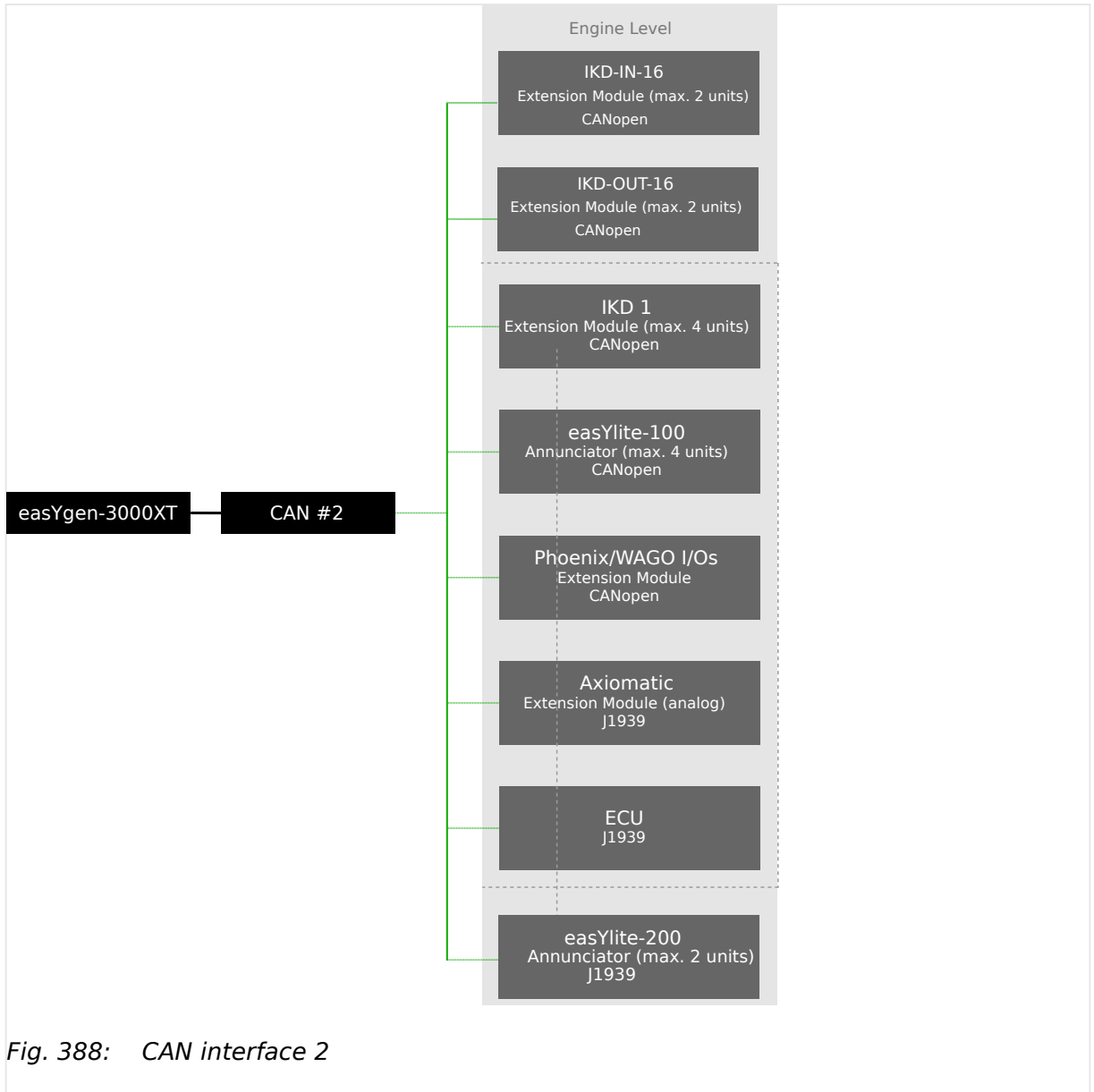

Fig. 388: CAN interface 2

CAN interface 2 is pre-configured for several expansion units. These include the I/O expansion boards Woodward IKD 1 (or IKD-IN-16 or IKD-OUT-16), several combinations of the expansion boards of the Phoenix Inline Modular (IL) series, and the support of Wago terminals.

It is possible to connect several combinations of up to four Woodward IKD 1s (or two IKD-IN-16 and two IKD-OUT-16) and/or Phoenix Inline Modular (IL) modules and/or WAGO modules with up to 32 discrete inputs/outputs, 16 analog inputs, and 4 analog outputs.

7.1.3 CAN Interface 3 (System level)

The CAN interface 3 is used for load sharing and the LSx communication.

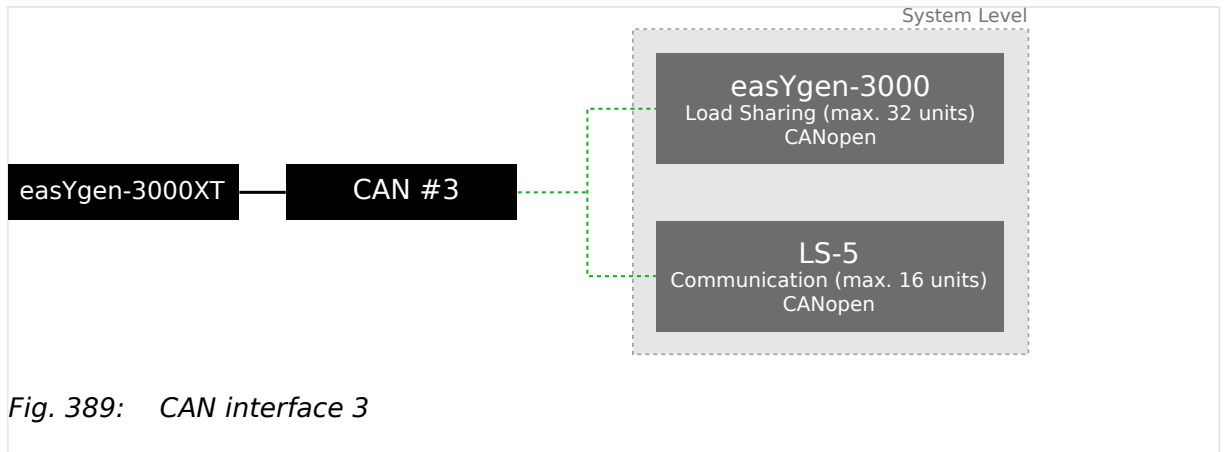

Fig. 389: CAN interface 3

7.2 Ethernet Interfaces

General notes

The Ethernet network provides a fast communication capability to different devices, like remote panel, PLC or SCADA systems. The common protocol Modbus TCP is there for the preferred communication protocol. Additionally the Ethernet connection supports the Woodward protocol Servlink for ToolKit and other Woodward own monitoring tools (like remote panel and SCADA visualization tool). At least the easYgen provides a UDP protocol for system relevant and time discrete information exchange.

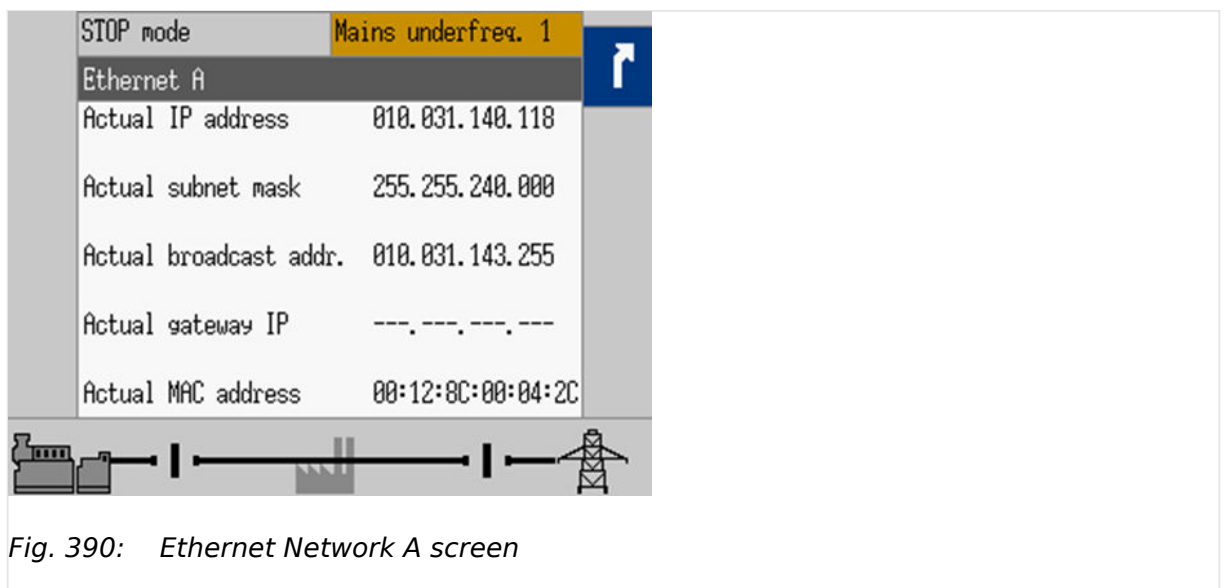

Fig. 390: Ethernet Network A screen

The actual IP address in Network A, subnet mask and gateway IP address can be viewed under Next Page (Status Menu) / Diagnostic / Interfaces / Ethernet / Ethernet A.

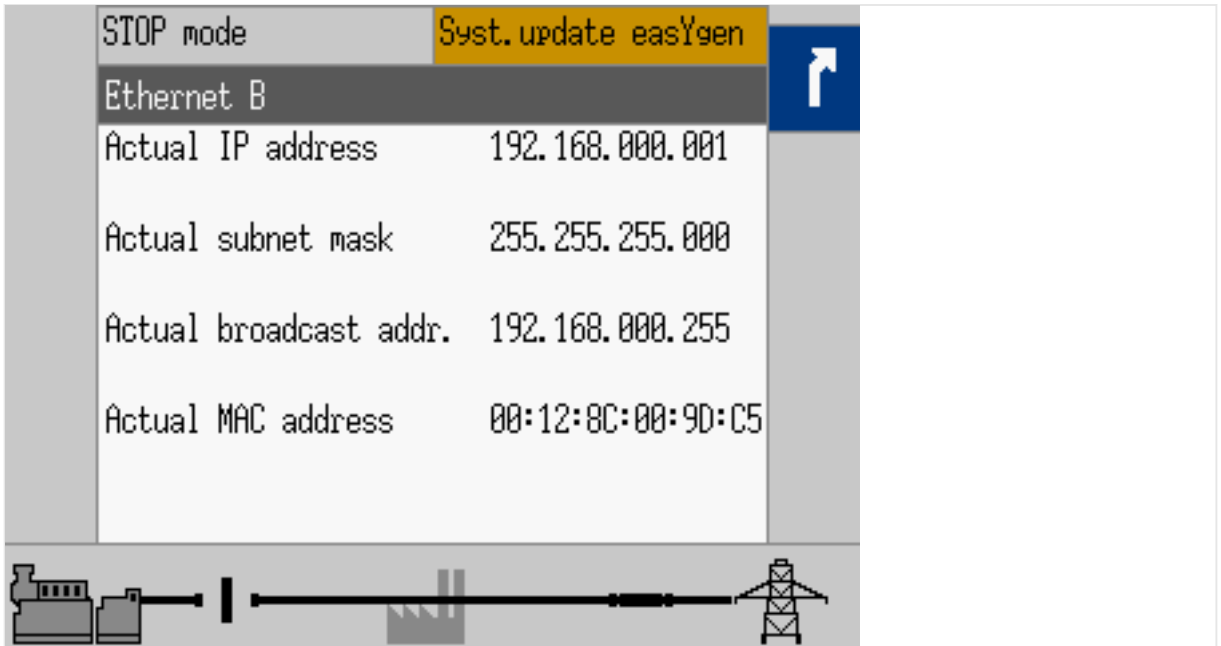

Fig. 391: Ethernet Network B screen

The actual IP address in Network B and the subnet mask can be viewed under Next Page (Status Menu) / Diagnostic / Interfaces / Ethernet / Ethernet B.

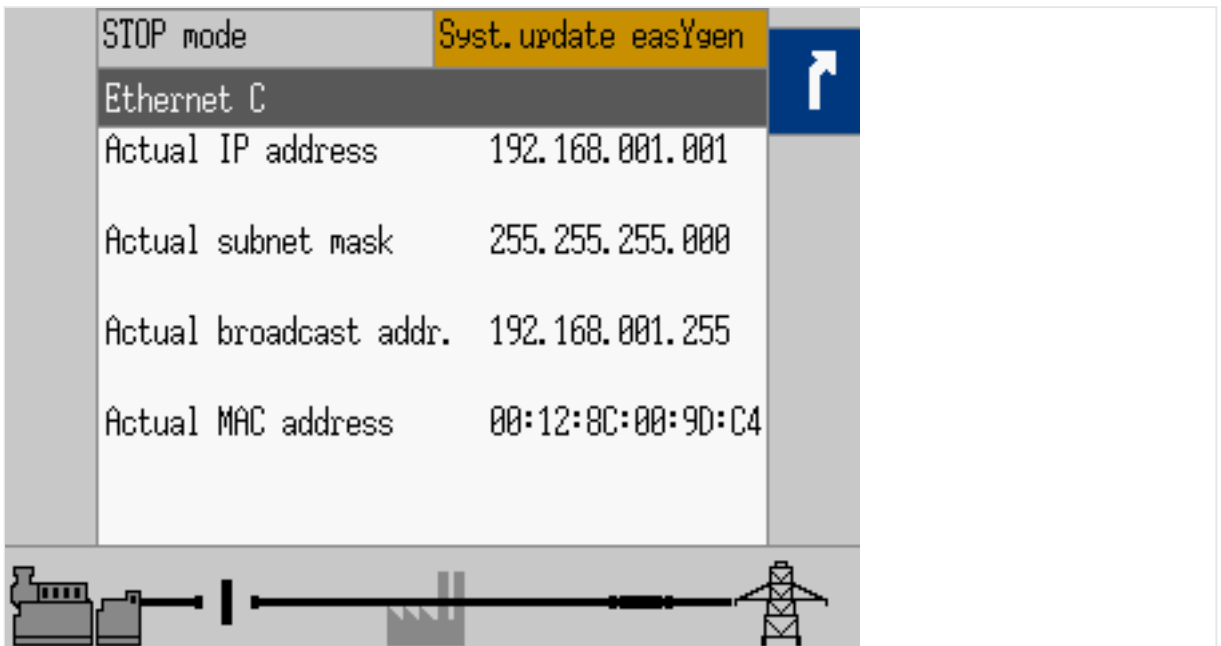

Fig. 392: Ethernet Network C screen

The actual IP address in Network C and the subnet mask can be viewed under Next Page (Status Menu) / Diagnostic / Interfaces / Ethernet / Ethernet C.

7.3 Serial Interfaces

7.3.1 RS-485 Interface (Serial Interface 2)

A freely configurable RS-485 Modbus RTU Slave interface is provided to add PLC connectivity. It is also possible to configure the unit, visualize measured data and alarm messages, and control the unit remotely.



Fig. 393: RS-485 interface

7.3.2 USB interface (USB 2.0, slave)



Service port

The USB interface follows the USB 2.0 standard but is - as a service port - reserved for ToolKit and special Woodward usage.

7.4 CANopen Protocol

CANopen is a communication protocol and device profile specification for embedded systems used in automation. The CANopen standard consists of an addressing scheme, several small communication protocols and an application layer defined by a device profile. The communication protocols have support for network management, device monitoring and communication between nodes, including a simple transport layer for message segmentation/de-segmentation.

Protocol description

If a data protocol is used, a CAN message looks like this:

Byte 0	Byte 1	Byte 2	Byte 3	Byte 4	Byte 5	Byte 6	Byte 7
MUX	Data byte	Data byte	Data byte	Data byte	Data byte	Data byte	Internal

The MUX byte is counted up, the meaning of the data byte changes according to the value of the MUX byte.

In the protocol tables is listed which parameter at which MUX on which position is transmitted. The meaning of the parameter can be taken by means of the number of the parameter description (For details refer to [“9.2 Data Protocols”](#)).

*	Example							
MUX	Byte 1	Byte 2	Byte 3	Byte 4	Byte 5	Byte 6	Byte 7	
1	118				147		Internal	

In MUX 1 (byte 0 has got value 1) the value of parameter 118 is included in the byte 1 up to byte 4 (mains voltage 1-2). In byte 6 up to byte 6 the value of parameter 147 is included (mains frequency). Byte 7 includes internal definitions and can be ignored.

Data format "Unsigned Integer"

UNSIGNED type data has positive integers as values. The range is between 0 and 2ⁿ-1. The data is shown by the bit sequence of length n.

- Bit sequence:

$$b = b_0 \text{ to } b_{-1}$$

- Value shown:

$$\text{UNSIGNED}_n(b) = b_{-1} * 2^{-1} + \dots + b_1 * 2^1 + b_0 * 2^0$$



Please note that the bit sequence starts on the left with the least significant byte.

Example: Value 266 = 10A hex of type UNSIGNED16 is transmitted on the bus in two octets, first 0A hex and then 01 hex.

The following UNSIGNED data types are transmitted as follows:

Octet Number	1.	2.	3.	4.	5.	6.	7.	8.
UNSIGNED8	b ₇ to b ₀							
UNSIGNED16	b ₇ to b ₀	b ₁₅ to b ₈						
UNSIGNED24	b ₇ to b ₀	b ₁₅ to b ₈	b ₂₃ to b ₁₆					
UNSIGNED32	b ₇ to b ₀	b ₁₅ to b ₈	b ₂₃ to b ₁₆	b ₃₁ to b ₂₄				
UNSIGNED40	b ₇ to b ₀	b ₁₅ to b ₈	b ₂₃ to b ₁₆	b ₃₁ to b ₂₄	b ₃₉ to b ₃₂			
UNSIGNED48	b ₇ to b ₀	b ₁₅ to b ₈	b ₂₃ to b ₁₆	b ₃₁ to b ₂₄	b ₃₉ to b ₃₂	b ₄₇ to b ₄₀		
UNSIGNED56	b ₇ to b ₀	b ₁₅ to b ₈	b ₂₃ to b ₁₆	b ₃₁ to b ₂₄	b ₃₉ to b ₃₂	b ₄₇ to b ₄₀	b ₅₅ to b ₄₈	
UNSIGNED64	b ₇ to b ₀	b ₁₅ to b ₈	b ₂₃ to b ₁₆	b ₃₁ to b ₂₄	b ₃₉ to b ₃₂	b ₄₇ to b ₄₀	b ₅₅ to b ₄₈	b ₆₃ to b ₅₆

Table 152: Transfer syntax for data type UNSIGNED_n

Data format "Signed Integer"

SIGNED type data has integers as values. The range is between 0 and 2ⁿ-1. The data is shown by the bit sequence of length n.

- Bit sequence:

$$b = b_0 \text{ to } b_{-1}$$

- Value shown:

$$\text{SIGNED}_n(b) = b_{-2} * 2^{-2} + \dots + b_1 * 2^1 + b_0 * 2^0$$

if $b_{-1} = 0$

- And with two's complement:

$$\text{SIGNED}_n(b) = \text{SIGNED}_n(\sim b) - 1$$

if $b_{-1} = 1$



Please note that the bit sequence starts on the left with the least significant byte.

Example: The value -266 = FEF6 hex of type SIGNED16 is transmitted in two octets, first F6 hex and then FE hex.

Octet Number	1.	2.	3.	4.	5.	6.	7.	8.
SIGNED8	b ₇ to b ₀							
SIGNED16	b ₇ to b ₀	b ₁₅ to b ₈						
SIGNED24	b ₇ to b ₀	b ₁₅ to b ₈	b ₂₃ to b ₁₆					
SIGNED32	b ₇ to b ₀	b ₁₅ to b ₈	b ₂₃ to b ₁₆	b ₃₁ to b ₂₄				
SIGNED40	b ₇ to b ₀	b ₁₅ to b ₈	b ₂₃ to b ₁₆	b ₃₁ to b ₂₄	b ₃₉ to b ₃₂			
SIGNED48	b ₇ to b ₀	b ₁₅ to b ₈	b ₂₃ to b ₁₆	b ₃₁ to b ₂₄	b ₃₉ to b ₃₂	b ₄₇ to b ₄₀		
SIGNED56	b ₇ to b ₀	b ₁₅ to b ₈	b ₂₃ to b ₁₆	b ₃₁ to b ₂₄	b ₃₉ to b ₃₂	b ₄₇ to b ₄₀	b ₅₅ to b ₄₈	
SIGNED64	b ₇ to b ₀	b ₁₅ to b ₈	b ₂₃ to b ₁₆	b ₃₁ to b ₂₄	b ₃₉ to b ₃₂	b ₄₇ to b ₄₀	b ₅₅ to b ₄₈	b ₆₃ to b ₅₆

Table 153: Transfer syntax for data type INTEGER

7.5 J1939 Protocol

The J1939 protocol is using an extended CAN identifier and can be used via CAN bus interface parallel to the CANopen protocol and ToolKit. All devices connected to the CAN bus interface must use the same baud rate independent of the selected protocol.

Most of the J1939 data is standardized and has a SPN (Suspect Parameter Number), which describes the data (e.g. SPN 110 is representing the value of the current "Engine Coolant Temperature"). The SPNs are packed in different PGNs (Parameter Group Numbers). The PGN is a part of the CAN ID and is representing one CAN message (e.g. SPN 110 is packed in PGN 65263). J1939 defines several hundred SPNs. However, only a small part is important for most of the applications. For this reason only a part of the SPNs is supported by the J1939 devices and by the easYgen.

'SAE J1939' also allows manufacturer-specific data areas, so called proprietary data, which are not defined in the standard. In most cases, these proprietary data is used for remote control purposes (like start/stop, speed set point) of ECUs (Engine Control Unit). Some manufacturers also issue specific error messages using manufacturer-specific data. Besides important standardized data, the easYgen is also supporting some proprietary data for the different ECUs. Please refer to [7.5.2 Supported J1939 ECUs & Remote Control Messages](#) for details.

7.5.1 Displayed Messages (Visualization)

Visualization messages like "Engine Coolant Temperature" of a device (for example an ECU) are received on the CAN bus according to J1939 protocol and are shown on the device display and the ToolKit configuration software. In most cases the visualization works with standard messages.

The easYgen is able to display all values listed in the table [↔](#) "Standard visualization messages" if they are supported by the connected device as well.



If a message is used but its sensor/signal is damaged HMI and ToolKit display »ERROR«.

Unused messages/SPN are monitored by ToolKit with »Missing« but HMI doesn't display unused messages/SPN (neither message/SPN nor status).

Diagnostic trouble codes (DM1/DM2)

In the J1939 status screen the first 10 active alarm messages (Active Diagnostic Trouble Codes - DM1) and the first 10 unacknowledged alarm messages (Previously Active Diagnostic Trouble Codes - DM2) with text, SPN, FMI, and OC are displayed.

Additionally, the state of the lamps (amber/red) is always displayed.

- SPN (= Suspect Parameter Number) indicates the measured value that the alarm code is referring (e.g. SPN = 100 corresponds to oil pressure).
- FMI (= Failure Mode Indicator) specifies the alarm more precisely (e.g. FMI = 3 means: value is above predefined limits)
- OC (Occurrence Count) indicates how often an alarm occurred.



The indication of fault texts for DM1 and the entry in the respective alarm list is only possible for SPNs which are listed in the SPN list (refer to [↔](#) "Standard visualization messages")!

For SPNs without text: Refer to the J1939 specification for a list of all SPNs.

Standard visualization messages



In case of ...

- ... defective sensor: "**Error**" is displayed.
- ... missing sensor: "**Missing**" is displayed.

SPN	PGN	Description	Resol.	Data range J1939	Index
38	65276	38:Fuel level 2 ⁴	0.1 %	0 to 100 %	12017
51	65266	51:Throttle valve 1 position 1 ⁴	0.1 %	0 to 100 %	10376
52	65262	52:Engine Intercooler Temp ²	1 °C	-40 to 210 °C	15217
91	61443	91:Accelerator Pedal Pos.1 ¹	0.1 %	0 to 100 %	15207
92	61443	92:Load At Current Speed ¹	1 %	0 to 250 %	15208

SPN	PGN	Description	Resol.	Data range J1939	Index
94	65263	94:Fuel Delivery Pressure ²	1 kPa	0 to 1000 kPa	15218
95	65276	95:Fuel Filter Diff. Pressure ²	1 kPa	0 to 500 kPa	15219
96	65276	96:Fuel level 1 ⁴	0.1 %	0 to 100 %	12016
97	65279	14.47 Water in fuel ⁶		(only LM)	1123
98	65263	98:Engine Oil Level ¹	0.1 %	0 to 100 %	15210
100	65263	100:Engine Oil Pressure ¹	1 kPa	0 to 1000 kPa	15205
101	65263	101:Crankcase Pressure ²	1 kPa	-250 to 251 kPa	15220
102	65270	102:Intake Manifold 1 Pressure ¹	1 kPa	0 to 500 kPa	15214
105	65270	105:Intake Manifold 1 Temp ¹	1 °C	-40 to 210 °C	15215
106	65270	106:Air Intake Pressure ²	1 kPa	0 to 500 kPa	15221
107	65270	107:Air Filter 1 Diff.Pressure ²	0.01 kPa	0 to 12.5 kPa	15222
108	65269	108:Barometric Pressure ¹	0.1 kPa	0 to 125 kPa	15212
109	65263	109:Coolant Pressure ²	1 kPa	0 to 500 kPa	15223
110	65262	110:Engine Coolant Temp ¹	1 °C	-40 to 210 °C	15202
111	65263	111:Coolant Level ¹	0.1 %	0 to 100 %	15206
127	65272	127:Transm. Oil Pressure ²	1 kPa	0 to 4000 kPa	15224
157	65243	157:Inj.Metering Rail 1 Press. ²	0.1 MPa	0 to 251 MPa	15225
158	65271	158:Keyswitch Batt.Potential ⁴	0.1 V	0 to 3212.75 V	15312
171	65269	171:Ambient Air Temperature ²	0.1 °C	-273 to 1735 °C	15226
172	65269	172:Air Intake Temperature ¹	1 °C	-40 to 210 °C	15213
173	65270	173:Exhaust Gas Temperature ¹	0.1 °C	-273 to 1735 °C	15216
174	65262	174:Fuel Temperature 1 ¹	1 °C	-40 to 210 °C	15203
175	65262	175:Oil Temperature 1 ¹	0.1 °C	-273 to 1735 °C	15309
176	65262	176:Turbo Oil Temp ²	0.1 °C	-273 to 1735 °C	15227
177	65272	177:Transmission Oil Temp.1 ²	0.1 °C	-273 to 1735 °C	15228
183	65266	183:Fuel Rate ¹	0.1 l/h	0 to 3212.75 l/h	15307
190	61444	190:Engine Speed ¹	1 rpm	0 to 8031.875 rpm	15308
247	65253	247:Total Engine Hours ^{1, 7}	1 h	0 to 210554060 h	15201
250	65257	250:Total fuel used ⁴	0.5 l	0 to 2105540608 l	15319
441	65164	441:Auxiliary Temp 1 ²	1 °C	-40 to 210 °C	15229
442	65164	442:Auxiliary Temp 2 ²	1 °C	-40 to 210 °C	15230
513	61444	513:Actual Engine Torque ¹	1 %	-125 to 125 %	15209
1081	65252	1081: Eng.wait to start lamp ⁵		enumeration	15508
1117	65193	1117:Desired rated exhaust O ₂ ⁴	0.00%	0 to 160.64 %	10362
1118	65193	1118:Desired exhaust O ₂ ⁴	0.00%	0 to 160.64 %	10364

SPN	PGN	Description	Resol.	Data range J1939	Index
1119	65193	1119:Actual exhaust O2 ⁴	0.00%	0 to 160.64 %	10366
1122	65191	1122:Alternator Bear. 1 Temp ²	1 °C	-40 to 210 °C	15231
1123	65191	1123:Alternator Bear. 2 Temp ²	1 °C	-40 to 210 °C	15232
1124	65191	1124:Alternator Wind. 1 Temp ²	1 °C	-40 to 210 °C	15233
1125	65191	1125:Alternator Wind. 2 Temp ²	1 °C	-40 to 210 °C	15234
1126	65191	1126:Alternator Wind. 3 Temp ²	1 °C	-40 to 210 °C	15235
1127	65190	1127:Turbo 1 boost pressure ⁴	0.0 kPA	0 to 8031.8 kPa %	10374
1131	65189	1131:Intake Manifold 2 Temp ²	1 °C	-40 to 210 °C	15236
1132	65189	1132:Intake Manifold 3 Temp ²	1 °C	-40 to 210 °C	15237
1133	65189	1133:Intake Manifold 4 Temp ²	1 °C	-40 to 210 °C	15238
1134	65262	1134:Intercooler Therm.Opening ²	0.1 %	0 to 100 %	15239
1135	65188	1135:Oil Temperature 2 ²	0.1 °C	-273 to 1735 °C	15240
1136	65188	1136:ECU Temperature ²	0.1 °C	-273 to 1735 °C	15241
1137	65187	1137:Exh.Gas Port 1 Temp ³	0.1 °C	-273 to 1735 °C	15242
1138	65187	1138:Exh.Gas Port 2 Temp ³	0.1 °C	-273 to 1735 °C	15243
1139	65187	1139:Exh.Gas Port 3 Temp ³	0.1 °C	-273 to 1735 °C	15244
1140	65187	1140:Exh.Gas Port 4 Temp ³	0.1 °C	-273 to 1735 °C	15245
1141	65186	1141:Exh.Gas Port 5 Temp ³	0.1 °C	-273 to 1735 °C	15246
1142	65186	1142:Exh.Gas Port 6 Temp ³	0.1 °C	-273 to 1735 °C	15247
1143	65186	1143:Exh.Gas Port 7 Temp ³	0.1 °C	-273 to 1735 °C	15248
1144	65186	1144:Exh.Gas Port 8 Temp ³	0.1 °C	-273 to 1735 °C	15249
1145	65185	1145:Exh.Gas Port 9 Temp ³	0.1 °C	-273 to 1735 °C	15250
1146	65185	1146:Exh.Gas Port 10 Temp ³	0.1 °C	-273 to 1735 °C	15251
1147	65185	1147:Exh.Gas Port 11 Temp ³	0.1 °C	-273 to 1735 °C	15252
1148	65185	1148:Exh.Gas Port 12 Temp ³	0.1 °C	-273 to 1735 °C	15253
1149	65184	1149:Exh.Gas Port 13 Temp ³	0.1 °C	-273 to 1735 °C	15254
1150	65184	1150:Exh.Gas Port 14 Temp ³	0.1 °C	-273 to 1735 °C	15255
1151	65184	1151:Exh.Gas Port 15 Temp ³	0.1 °C	-273 to 1735 °C	15256
1152	65184	1152:Exh.Gas Port 16 Temp ³	0.1 °C	-273 to 1735 °C	15257
1153	65183	1153:Exh.Gas Port 17 Temp ³	0.1 °C	-273 to 1735 °C	15258
1154	65183	1154:Exh.Gas Port 18 Temp ³	0.1 °C	-273 to 1735 °C	15259
1155	65183	1155:Exh.Gas Port 19 Temp ³	0.1 °C	-273 to 1735 °C	15260
1156	65183	1156:Exh.Gas Port 20 Temp ³	0.1 °C	-273 to 1735 °C	15261
1157	65182	1157:Main Bearing 1 Temp ³	0.1 °C	-273 to 1735 °C	15262
1158	65182	1158:Main Bearing 2 Temp ³	0.1 °C	-273 to 1735 °C	15263

SPN	PGN	Description	Resol.	Data range J1939	Index
1159	65182	1159:Main Bearing 3 Temp ³	0.1 °C	-273 to 1735 °C	15264
1160	65182	1160:Main Bearing 4 Temp ³	0.1 °C	-273 to 1735 °C	15265
1161	65181	1161:Main Bearing 5 Temp ³	0.1 °C	-273 to 1735 °C	15266
1162	65181	1162:Main Bearing 6 Temp ³	0.1 °C	-273 to 1735 °C	15267
1163	65181	1163:Main Bearing 7 Temp ³	0.1 °C	-273 to 1735 °C	15268
1164	65181	1164:Main Bearing 8 Temp ³	0.1 °C	-273 to 1735 °C	15269
1165	65180	1165:Main Bearing 9 Temp ³	0.1 °C	-273 to 1735 °C	15270
1166	65180	1166:Main Bearing 10 Temp ³	0.1 °C	-273 to 1735 °C	15271
1167	65180	1167:Main Bearing 11 Temp ³	0.1 °C	-273 to 1735 °C	15272
1172	65178	1172:Turbo1 Compr.Intake Temp ⁴	0.1 °C	-273 to 1735 °C	15273
1173	65178	1173:Turbo2 Compr.Intake Temp ⁴	0.1 °C	-273 to 1735 °C	15274
1174	65178	1174:Turbo3 Compr.Intake Temp ⁴	0.1 °C	-273 to 1735 °C	15275
1175	65178	1175:Turbo4 Compr.Intake Temp ⁴	0.1 °C	-273 to 1735 °C	15276
1176	65177	1176:Turbo1 Compr.Intake Press ⁴	1 kPa	-250 to 251 kPa	15277
1177	65177	1177:Turbo2 Compr.Intake Press ⁴	1 kPa	-250 to 251 kPa	15278
1178	65177	1178:Turbo3 Compr.Intake Press ⁴	1 kPa	-250 to 251 kPa	15279
1179	65177	1179:Turbo4 Compr.Intake Press ⁴	1 kPa	-250 to 251 kPa	15280
1180	65176	1180:Turbo1 Intake Temp ⁴	0.1 °C	-273 to 1735 °C	15281
1181	65176	1181:Turbo2 Intake Temp ⁴	0.1 °C	-273 to 1735 °C	15282
1182	65176	1182:Turbo3 Intake Temp ⁴	0.1 °C	-273 to 1735 °C	15283
1183	65176	1183:Turbo4 Intake Temp ⁴	0.1 °C	-273 to 1735 °C	15284
1184	65175	1184:Turbo1 Outlet Temp ⁴	0.1 °C	-273 to 1735 °C	15285
1185	65175	1185:Turbo2 Outlet Temp ⁴	0.1 °C	-273 to 1735 °C	15286
1186	65175	1186:Turbo3 Outlet Temp ⁴	0.1 °C	-273 to 1735 °C	15287
1187	65175	1187:Turbo4 Outlet Temp ⁴	0.1 °C	-273 to 1735 °C	15288
1203	65172	1203:Aux.Coolant Press ⁴	1 kPa	0 to 1000 kPa	15289
1208	65170	1208:Pre-filter Oil Pressure ⁴	1 kPa	0 to 1000 kPa	15290
1212	65172	1212:Aux. Coolant Temperature ⁴	1 °C	-40 to 210 °C	15291
1382	65130	1382:Fuel Filter Diff. Press ⁴	1 kPa	0 to 500 kPa	15292
1695	65193	1695:O2 Sens.fueling correct. ⁴	000%	-125 to 125 %	10368
1696	65193	1696:O2 sensor closed loop op. ⁵		enumeration	10370
1761	65110	1761:Aftertr.1 Exh.Tank1 Lev. ⁴	0.1%	0 to 100%	15313
1765	65153	1765:Request.fuel valve 1 pos. ⁴	000.0%	0 to 100 %	10372
1800	65104	1800:Battery 1 Temperature ⁴	1 °C	-40 to 210 °C	15293
1801	65104	1801:Battery 2 Temperature ⁴	1 °C	-40 to 210 °C	15294

7 Interfaces And Protocols

7.5.1 Displayed Messages (Visualization)

SPN	PGN	Description	Resol.	Data range J1939	Index
1802	65189	1802: Intake Manifold 5 Temp ⁴	1 °C	-40 to 210 °C	15295
1803	65189	1803: Intake Manifold 6 Temp ⁴	1 °C	-40 to 210 °C	15296
2433	65031	2433: Right Exhaust Gas Temp ⁴	0.1 °C	-273 to 1735 °C	15297
2434	65031	2434: Left Exhaust Gas Temp ⁴	0.1 °C	-273 to 1735 °C	15298
2629	64979	2629: Turbo1 Compr. Outl. Temp ⁴	0.1 °C	-273 to 1736 °C	15310
3031	65110	3031: Aftertr.1 Exh. Tank1 Temp. ⁴	1 °C	-40 to 210 °C	15314
3216	61454	3216: Aftertreatm.1 NOx intake ⁴	0.05 ppm	-200 to 3012.75 ppm	15909
3226	61455	3226: Aftertreatm.1 NOx outlet ⁴	0.05 ppm	-200 to 3012.75 ppm	15911
3237	65247	3237 Aftertr. 1 int. dew point ⁵		enumeration	10379
3238	65247	3238 Aftertr. 1 exh. dew point ⁵		enumeration	10381
3239	65247	3239 Aftertr. 2 int. dew point ⁵		enumeration	10383
3240	65247	3240 Aftertr. 2 exh. dew point ⁵		enumeration	10385
3251	64946	3251: DPF Differential press. ⁴	0.1 kPa	0 to 6425.5 kPa	15550
3380	64934	3380: Excitation volt. ⁵	0.05 V	-1606.00 to 1606.75 V	15904
3381	64934	3381: Excitation curr. ⁵	0.05 A	0 to 3212.75 A	15905
3517	65110	3517: Aftertr.1 Exh. Tank Lev.2 ⁴	0.0000 m	0 to 6.4255 m	17591
3644	64914	3644: Derate Request ⁴	0.1 %	0 to 100%	15311
3697	64892	3697: DPF Lamp ⁵		enumeration	15504
3698	64892	3698: Exh. Gas temp.lamp ⁵		enumeration	15505
3699	64892	3699: DPF Passive regen. state ⁵		enumeration	15608
3700	64892	3700: DPF Active regen. status ⁵		enumeration	15506
3701	64892	3701: DPF Regeneration needed ⁵		enumeration	15507
3702	64892	3702: DPF Act. regen. inhibit ⁵		enumeration	15607
3703	64892	03.87 Inhibit Switch ⁶		enumeration (only LM)	11030
3711	64892	03.88 Low exhaust temp. ⁶		enumeration (only LM)	11031
3712	64892	03.89 System fault active ⁶		enumeration (only LM)	11032
3713	64892	03.90 System timeout ⁶		enumeration (only LM)	11033
3714	64892	03.91 Temporary lockout ⁶		enumeration (only LM)	11034
3715	64892	03.92 Permanent lockout ⁶		enumeration (only LM)	11035
3716	64892	03.93 Engine not warmed up ⁶		enumeration (only LM)	11036

SPN	PGN	Description	Resol.	Data range J1939	Index
3719	64891	3719:DPF 1 Soot load ⁴	1 %	0 to 250 %	12018
3720	64891	3720:DPF 1 Ash load ⁴	1 %	0 to 250 %	12019
3721	64891	3721 DPF1 time since regen. ⁴	1 s	0 to 4211081215 s	12043
3750	64892	03.86 DPF1 Act.reg.inhibit ⁶		enumeration (only LM)	11029
3251	64946	3251:DPF Differential press.	0.1 kPa	0 to 6,425.5 kPa	15550
4151	64851	4151: Exhaust Gas Temp. Avr. ³	0.1 °C	-273 to 1734 °C	12807
4152	64851	4152: Exh. Gas Temp. Avr. B2 ³	0.1 °C	-273 to 1734 °C	12812
4153	64851	4153: Exh. Gas Temp. Avr. B1 ³	0.1 °C	-273 to 1734 °C	12809
4332	61475	4332: SCR System state ⁵		enumeration	12049
4367	64829	4367:Aftertr.1 Exh.Tank2 Lev. ⁴	0.1 %	0 to 100%	15315
4368	64829	4367:Aftertr.1 Exh.Tank2 Lev. ⁴	1 °C	-40 to 210 °C	15316
4765	64800	4765:Aft.1 Ox. Cat. Int. Gas T ⁴	0.1 °C	-273 to 1734.9	10388
4766	64800	4766:Aft.1 Ox. Cat. Out. Gas T ⁴	0.1 °C	-273 to 1734.9	10398
4990	64789	4990: Charger 1 state ⁵		enumeration	15913
4991	64789	4991: Charger 1 power line ⁵		enumeration	15914
4992	64789	4992: Charger 1 output volt. ⁴	0.05 V	0 to 3212.75 V	15915
4993	64789	4993: Charger 1 output current ⁴	0.05 A	-1600 to 1612.75 A	15916
5245	65110	5245: SCR Inducement (DEF) ⁵		enumeration	12047
5246	65110	5246: SCR Inducement severity ⁵		enumeration	12048
5466	64891	5466 DPF1 soot load threshold ⁴	0.01 %	0 to 160.63 %	12044
6915	64586	6915: SCR Cleaning Lamp ⁵		enumeration	12050

Notes to SPNs:

- ¹Value located at "J1939 Analog values 1"
- ²Value located at "J1939 Analog values 2"
- ³Value located at "J1939 Analog values 3"
- ⁴Value located at "J1939 Analog values 4"
- ⁵Value located at "J1939 Status miscellaneous". (Additionally there are "Logical Command Variables".)
- ⁶Value only available as "Logical Command Variable" or "AnalogManager Variable"
- ⁷ If the total engine hours sent by the ECU exceed 419,000 hrs, the display in the unit is not correct anymore.

Data transmission engine control unit (ECU)

- If the sent values exceed the limits of the specification, the displayed value is not defined.
- If a value of the ECU is not sent or sent as not available or defective, the value will be displayed as indicated in the table before.

Special Deutz EMR2/Volvo EDC4 messages

These values are located at screen "J1939 Special".

Suspect parameter number	Parameter group number	Description
Engine stop	65301 (FF15h)	0 to 250

Please refer to the ECU manual for the engine specific stop codes.



Special Scania S6 messages

These values are located at screen "J1939 Special".

Scania S6 message	Value	Corresponding Analog/Logic Variables
DLN2	15300 Low engine oil level	
	15301 High engine oil level	
	15302 Low oil pressure	
	15303 High engine coolant temp.	
	Power Lost Due to High Temp.	LM 03.17  "9.3.2.3 Group 03: Engine control"

Special Scania S8 messages

These values are located at screen "J1939 Special".

Scania S8 message	Value	Corresponding Analog/Logic Variables
DLN2	15300 Low engine oil level	
	15301 High engine oil level	
	15302 Low oil pressure	
	15303 High engine coolant temp.	
	Power Lost Due to High Temp.	LM 03.17  "9.3.2.3 Group 03: Engine control"
	Low Urea Level	LM 03.18  "9.3.2.3 Group 03: Engine control"
DLN7	15313 1761:Aftertr.1 Exh.Tank1 Lev. (assigned to SPN 1761 indication)	AM 09.08  "9.4.2.8 Group 09: J1939 values 2"

Scania S8 message	Value	Corresponding Analog/Logic Variables
	15900 Time to torque limiting	AM 09.29 ↪ "9.4.2.8 Group 09: J1939 values 2"
	11173 14.22 After run active	LM 14.22 ↪ "9.3.2.14 Group 14 Engine control 2"
DLN8	15398 DPF regen. countdown timer	AM 09.26 ↪ "9.4.2.8 Group 09: J1939 values 2"
	15399 Urea level inducement state	LM 14.23-14.25 ↪ "9.3.2.14 Group 14 Engine control 2"
	15694 Emission inducem.fail. reason	LM 14.26-14.29 ↪ "9.3.2.14 Group 14 Engine control 2"
ADS	15695 HC evaporation state	LM 14.30-14.32 ↪ "9.3.2.14 Group 14 Engine control 2"
	15696 HC evaporat. required action	LM 14.33-14.35 ↪ "9.3.2.14 Group 14 Engine control 2"
	15697 HC evaporation progress timer	AM 09.27 ↪ "9.4.2.8 Group 09: J1939 values 2"
	156846 HC evaporation start timer	AM 09.28 ↪ "9.4.2.8 Group 09: J1939 values 2"

Special Volvo EMS 2 messages (release 2.10-1 or higher)

These values are located at screen "J1939 Special".

Volvo message	Value	Corresponding Analog/Logic Variables
VP 71 VP Engine industry	15859 Restored operation	LM 03.73 to 03.74 ↪ "9.3.2.3 Group 03: Engine control"
VP 188	15999 Total aftertr. reagent	LM 09.36 ↪ "9.4.2.8 Group 09: J1939 values 2"
VP 191 OBD Information	15855 Time left to torque reduction	AM 09.19 ↪ "9.4.2.8 Group 09: J1939 values 2"
	15856 Time left to sev.torq. reduct.	AM 09.20 ↪ "9.4.2.8 Group 09: J1939 values 2"
	15857 SCR inducement severity	LM 03.75 to 03.80 ↪ "9.3.2.3 Group 03: Engine control"
	15858 SCR inducement reason	LM 03.81 to 03.85 ↪ "9.3.2.3 Group 03: Engine control"
VP 282 EIO Status (Emergency Inducement Override)	15852 Number of EIO activation	AM 09.21 ↪ "9.4.2.8 Group 09: J1939 values 2"
	15853 Accumulated EIO time	AM 09.22 ↪ "9.4.2.8 Group 09: J1939 values 2"
	15854 Time left EIO operation	AM 09.23 ↪ "9.4.2.8 Group 09: J1939 values 2"

Special FPT MD 1 flags (release 2.15-0 or higher)

These data are only available as logic variables.

FPT MD 1 message	Value	Corresponding Logic Variables
EDC2BC	Coolant temperature: prewarning	LM 14.48 ⇨ “9.3.2.14 Group 14 Engine control 2”
	Coolant temperature: warning	LM 14.49 ⇨ “9.3.2.14 Group 14 Engine control 2”
	Low engine oil pressure	LM 14.50 ⇨ “9.3.2.14 Group 14 Engine control 2”
ENG06	After run	LM 14.22 ⇨ “9.3.2.14 Group 14 Engine control 2”
	Clogging fuel filter: clogged	LM 14.51 ⇨ “9.3.2.14 Group 14 Engine control 2”
	Clogging fuel prefilter: clogged	LM 14.52 ⇨ “9.3.2.14 Group 14 Engine control 2”
	System tampering inducement: Warning	LM 14.53 ⇨ “9.3.2.14 Group 14 Engine control 2”
	System tampering inducement: Moderate	LM 14.54 ⇨ “9.3.2.14 Group 14 Engine control 2”
	System tampering inducement: Severe	LM 14.55 ⇨ “9.3.2.14 Group 14 Engine control 2”
	DEF level inducement: warning	LM 14.56 ⇨ “9.3.2.14 Group 14 Engine control 2”
	DEF level inducement: Moderate	LM 14.57 ⇨ “9.3.2.14 Group 14 Engine control 2”
	DEF level inducement: Severe	LM 14.58 ⇨ “9.3.2.14 Group 14 Engine control 2”
	DEF quality inducement: warning	LM 14.59 ⇨ “9.3.2.14 Group 14 Engine control 2”
	DEF quality inducement: Moderate	LM 14.60 ⇨ “9.3.2.14 Group 14 Engine control 2”
	DEF quality inducement: Severe	LM 14.61 ⇨ “9.3.2.14 Group 14 Engine control 2”

7.5.2 Supported J1939 ECUs & Remote Control Messages

The following table lists all ECUs, which are supported by the easYgen beyond the J1939 standard with the appropriate settings. We recommend "Device type" (parameter ⇨ 15102) "Standard" or "Standard C" for all ECUs, which are **not listed** here. All other parameters shall be clarified with the ECU manufacturer.

ECU	Device type (15102)	J1939 own address (15106)	Engine control address (15107)	SPN version (15103)	Comment
Standard ECUs	Standard	Refer to ECU manual.	Refer to ECU manual.	Refer to ECU manual.	Please refer to 7.5.3 Device Types "Standard" and "Standard C" for more details.
Standard ECUs (with message counter and checksum)	Standard C	Refer to ECU manual.	Refer to ECU manual.	Refer to ECU manual.	Please refer to 7.5.3 Device Types "Standard" and "Standard C" for more details.
Woodward EGS, E3, E6, PG+	EGS Woodward	234	0	N/A	
MTU ADEC ECU7	ADEC ECU7 MTU	1	128	N/A	The easYgen is connected with the SAM via CAN. The SAM communicates with the ADEC using an own bus.
Deutz EMR2 Volvo EDC4	EMR2 Deutz	3	0	Version 1	
Deutz EMR3 Deutz EMR4 (EDC 17)	Standard	3	0	N/A	
Volvo EMS2 Volvo EMS1 Volvo EDC3	EMS2 Volvo	17	0	N/A	The rated speed of the EMS1 and EDC3 cannot be switched via the easYgen.
Scania S6	S6 Scania	39	0	N/A	
Scania S8	S8 Scania	39	0	N/A	
MAN MFR/EDC7	MFR/EDC7 MAN	253	39	N/A	The easYgen is connected with the MFR via CAN. The MFR communicates with the EDC7 using an own bus.
SISU EEM2/3	EEM SISU	N/A	0 / (1)	N/A	
Cummins	Cummins	220	0	N/A	Notes Some Cummins setups need a special value for "Governor Gain" otherwise they will shut down. In this cases please set the "Governor Gain" of the ECU to »Internal« instead of »J1939«.
MTU ADEC ECU8/ ECU9	ADEC ECU8/9 MTU	234	0	N/A	The easYgen is connected with the MTU system: ADEC ECU8 & SmartConnect or ADEC ECU9.
Hatz EDC 17	Hatz EDC 17	3	0	N/A	
FPT MD1	FPT MD1	33	0	N/A	
ECU file	ECU file			N/A	This is to support ECUs which are not represented by the selection. Enter file name with parameter 15167 "ECU file name".

 The addresses listed here are only valid, if the ECU is not configured to other values. In case of doubt, please check the corresponding settings of the ECU with the service tool.

The following data is only transmitted to the corresponding ECU, if parameter 15127 "ECU remote controlled" is configured to "On", and parameter 15102 "Device type" is configured to one of the available ECU modes (if "Off" is configured, no J1939 remote control messages will be sent as well).

 Please note that some ECU manufacturers require that this functionality must be enabled first. In some cases, this is only possible by the manufacturer. Please consider this when ordering the ECU.

- 1 Woodward EGS, E3, E6, PG+ series
- 2 Scania S6/S8
- 3 Deutz EMR2/EMR3 / Volvo EDC4
- 4 Volvo EMS2
- 5 Volvo EMS1/EDC3
- 6 MTU ADEC ECU7
- 7 MAN MFR/EDC7
- 8 Standard, Standard C
- 9 SISU EEM 2/3
- 10 Cummins
- 11 MTU ADEC ECU8/ECU9
- 12 Hatz EDC 17
- 13 FPT MD1

Remote control function	Availability with supported ECU number ...													Comment
	1	2	3	4	5	6	7	8	9	10	11	12	13	
Engine Start	No	Yes	No	Yes	Yes	Yes	Yes	No	No / Yes	Yes	Yes	Yes	No	If an engine start command is initiated by the easYgen, this information is transmitted in the form of a J1939 message bit to an ECU. If ignition speed is reached, this bit will be reset (LogicsManager command variable 03.02. "Starter").
Engine Stop	Yes	Yes	No	Yes	Yes	Yes	Yes	Yes	No / Yes	Yes	Yes	Yes	No	This J1939 bit information is set, if a "Stop" command in

Remote control function	Availability with supported ECU number ...													Comment	
	1	2	3	4	5	6	7	8	9	10	11	12	13		
															automatic or manual mode is present in the easYgen. The "Stop" bit information remains set, until ignition speed is fallen below. After ignition speed has been fallen below, the "Stop" bit will be reset (LogicsManager command variable 03.27. "Stop solenoid").
Droop mode	Yes	Yes	No	Yes	Yes	Yes	Yes	Yes	Yes	Yes	No	No	No	This J1939 bit information is set, if a "Start" command in automatic or manual mode is initiated by the easYgen. The bit remains set until the engine has been stopped.	
														<p>Notes</p> <p>This message is only sent, if the LogicsManager output "86.25 LM: Freq. droop act." is TRUE.</p>	
Idle Mode	No	Yes	No ¹	Yes	Yes	No	No ¹	No ¹	No	Yes	Yes	No	No	<p>This J1939 bit information is set, if "Idle" mode is active (LogicsManager command variable 04.15. "Idle run active" is TRUE).</p> <p>The bit will be reset, if "Idle" mode is no longer active (LogicsManager command variable 04.15. "Idle run active" is FALSE).</p>	
50/60 Hz switch	Yes	Yes	No	Yes ²	No	Yes	No ¹	No	No	Yes	Yes	No	No	The J1939 information for 50 or 60 Hz mode is sent to the ECU depending on the "Rated system frequency" parameter	

Remote control function	Availability with supported ECU number ...													Comment	
	1	2	3	4	5	6	7	8	9	10	11	12	13		
															setting (↪ 1750) within the easYgen .
Speed bias	Yes ³	Yes ⁴	Yes ³	Yes ⁴	Yes ³	Yes ³	Yes ³	Yes ³	Yes ³	Yes ³	Yes ⁴	Yes ³	Yes	Yes ³	Refer to parameter ↪ 5537 for detailed information.
															<p>Notes</p> <p>Analog signal only</p>
Preglow	No	No	No	Yes	Yes	No	No	No	No	No	No	No	No	No	<p>This J1939 bit information is set, if the easYgen is in "Preglow" mode (LogicsManager command variable 03.04. "Preglow/ Ignition" is TRUE).</p> <p>The bit will be reset, if the "Preglow" phase has been expired or aborted.</p>
Override	No	Yes	No	Yes	No	Yes	No	Yes	No	Yes	Yes	No	No	No	<p>This J1939 bit information is set, if the easYgen is in critical mode (LogicsManager command variable 04.27. "Critical mode" is TRUE).</p> <p>The bit will be reset, if the critical mode has been expired or aborted.</p>
Engine power mode	No	No	No	No	No	No	No	No	No	No	Yes	No	No	No	This message is generated according to parameter "ECU power mode" (parameter ↪ 12939).
Engine selected application	No	No	No	No	No	No	No	No	No	No	Yes	No	No	No	This message is generated according to parameter "ECU application" (parameter ↪ 4843).



- ¹ Please contact manufacturer to clarify whether both frequencies (50/60 Hz) may be controlled by the speed bias.
- ² In case the rated speed of the easYgen and the ECU don't match, please make sure that the CAN connections works and change parameter \hookrightarrow 1750 of the easYgen once.
- ³ Speed biasing signal is transmitted as absolute value.
- ⁴ Speed biasing signal is transmitted as Offset value.

7.5.3 Device Types "Standard" and "Standard C"

General notes

If the used ECU is not specific listed in the chapter \hookrightarrow "7.5 J1939 Protocol" (e.g. Deutz (EMR3 & EMR4), John Deere, Daimler, Perkins, Iveco, Caterpillar, Liebherr, etc.) we recommend to configure the "Device type" (parameter \hookrightarrow 15102) to the setting Standard. Visualization via J1939 is working with every J1939 ECU. Concerning remote control most ECUs are also supporting the speed biasing via J1939 standard message TSC1. This chapter supplies you with the details of the device type standard, to help you to clarify with the manufacturer how the ECU is supported.

Displayed messages (visualization)

In standard mode, the easYgen is able to display all values listed in the table \hookrightarrow "Standard visualization messages" if they are supported by the connected ECU.

Diagnostic trouble codes (DM1/DM2)

In standard mode, the easYgen diagnostic messages DM1 (Active Diagnostic Trouble Codes) and DM2 (Previously Active Diagnostic Trouble Codes) are displayed. It is also possible to reset DM1 and DM2 failure codes via DM3 and DM11 messages.

Remote control messages

The following table shows the transmitted remote control messages. These messages are only transmitted if the parameter "ECU remote controlled" (parameter \hookrightarrow 15127) is configured to "On".



All listed messages are according to J1939 standard protocol.
Not all SPNs of the supported PGNs are listed here, in such case the easYgen transmits "Not available".

PGN		Acronym	Name	SPN	Description	Rate [ms]
Dec	Hex					
0	0000	TSC1	Torque/Speed Control 1	695	Engine Override Control Mode (fixed to "Speed Control")	10
				696	Requested Speed Control Conditions (fixed to "Transient Optimized")	
				897	Override Control Mode Priority (fixed to "Highest Priority")	

7 Interfaces And Protocols

7.5.3 Device Types "Standard" and "Standard C"

PGN		Acronym	Name	SPN	Description	Rate [ms]
Dec	Hex					
				898	Engine Requested Speed/Speed Limit	
				4206	Message Counter (Only if type "Standard C" is configured.)	
				4207	Message Checksum (Only if type "Standard C" is configured.)	
57344	E000	CM1	Cab Message 1	3695	Diesel Particulate Filter Regeneration Inhibit Switch active if LM 86.48 LM: Inhibit regener. is TRUE.	1000
				3696	Diesel Particulate Filter Regeneration Force Switch active if LM 86.49 LM: Force regener. is TRUE.	
61441	F001	EBC1	Electronic Brake Controller 1	970	Engine Auxiliary Shutdown Switch	100
61470	F01E	GC2	Generator Control 2	3938	Generator Governing Bias	20
65029	FE05	GTACP	Generator Total AC Power	2452	Generator Total Real Power	100
64913	FD91	ACS	AC Switching Device Status	3545	Generator Circuit Breaker Status	250
				3546	Utility Circuit Breaker Status	
64971	FDCB	OHECS	Off-Highway Engine Control Selection	2881	Engine Alternate Droop Accelerator 1 Select	500
					Notes If droop shall be active (LogicsManager 86.25 = TRUE) the easYgen is transmitting "Normal Droop" else "Alternate Droop Setting 1".	
65265	FEF1	CCVS	Cruise Control/Vehicle Speed	1237	Engine Shutdown Override Switch	100
59904	EA00	—	Request (specific)	247	Engine Total Hours of Operation (at PGN FEE5)	10,000
				—	DM11 Diagnostic Data Clear/Reset For Active DTCs (at PGN FED3)	
				—	DM3 Diagnostic Data Clear/Reset Of Previously Active DTCs (at PGN FECE)	
					Notes DM3 and DM11 are only transmitted if triggered.	
59904	EA(FF)	—	Request (global)	—	DM2 Previously diagnostic trouble codes (at PGN FECB)	2,000
				—	DM11 Diagnostic Data Clear/Reset For Active DTCs (at PGN FED3)	
				—	DM3 Diagnostic Data Clear/Reset Of Previously Active DTCs (at PGN FECE)	

PGN		Acronym	Name	SPN	Description	Rate [ms]
Dec	Hex					
				441	Auxiliary Temperature 1 (at PGN FE8C)	
				442	Auxiliary Temperature 2 (at PGN FE8C)	
					Notes DM3 and DM11 are only transmitted if triggered.	

Configure J1939 addresses

For the visualization the "J1939 own address" (parameter [↩ 15106](#)) and the "Engine control address" (parameter [↩ 15103](#)) are not relevant. But for remote control e.g. speed biasing these addresses must be configured correctly. Please refer to your ECU manual for the correct address. Normally the "Engine control address" (parameter [↩ 15103](#)) is "0" and the "J1939 own address" (parameter [↩ 15106](#)) is often "234" or "3".

7.6 Modbus Protocol

Modbus is a serial communications protocol published by Modicon in 1979 for use with its programmable logic controllers (PLCs). It has become a de facto standard communications protocol in industry, and is now the most commonly available means of connecting industrial electronic devices.

The Woodward controller supports

- a **Modbus RTU Slave** module for RS-485 connections

The Modbus RTU Slave expects that a Master node polls the controller slave node. Modbus RTU can also be multi-dropped, or in other words, multiple Slave devices can exist on one Modbus RTU network, assuming that the serial interface is a RS-485.

The Modbus/TCP Server fulfills the same role as Modbus client for RTU mode. Also here it is possible to have one client connected to many servers.

Detailed information about the Modbus protocol is available on the following website:

- [⇒ https://www.modbus.org/specs.php](https://www.modbus.org/specs.php)

There are also various tools available on the internet. We recommend using ModScan32 which is a Windows application designed to operate as a Modbus Master device for accessing data points in a connected Modbus Slave device. It is designed primarily as a testing device for verification of correct protocol operation in new or existing systems.

A trial version download is available from the following website:

- [⇒ https://www.win-tech.com/html/modscan32.htm](https://www.win-tech.com/html/modscan32.htm)

Address range

The controller Modbus Slave module distinguishes between visualization data and configuration & remote control data. The different data is accessible over a split address range and can be read via the "Read Holding Register" function.

Furthermore, controller parameters and remote control data can be written with the "Preset Single Registers" function or "Preset Multiple Registers" (↩ Fig. 394)

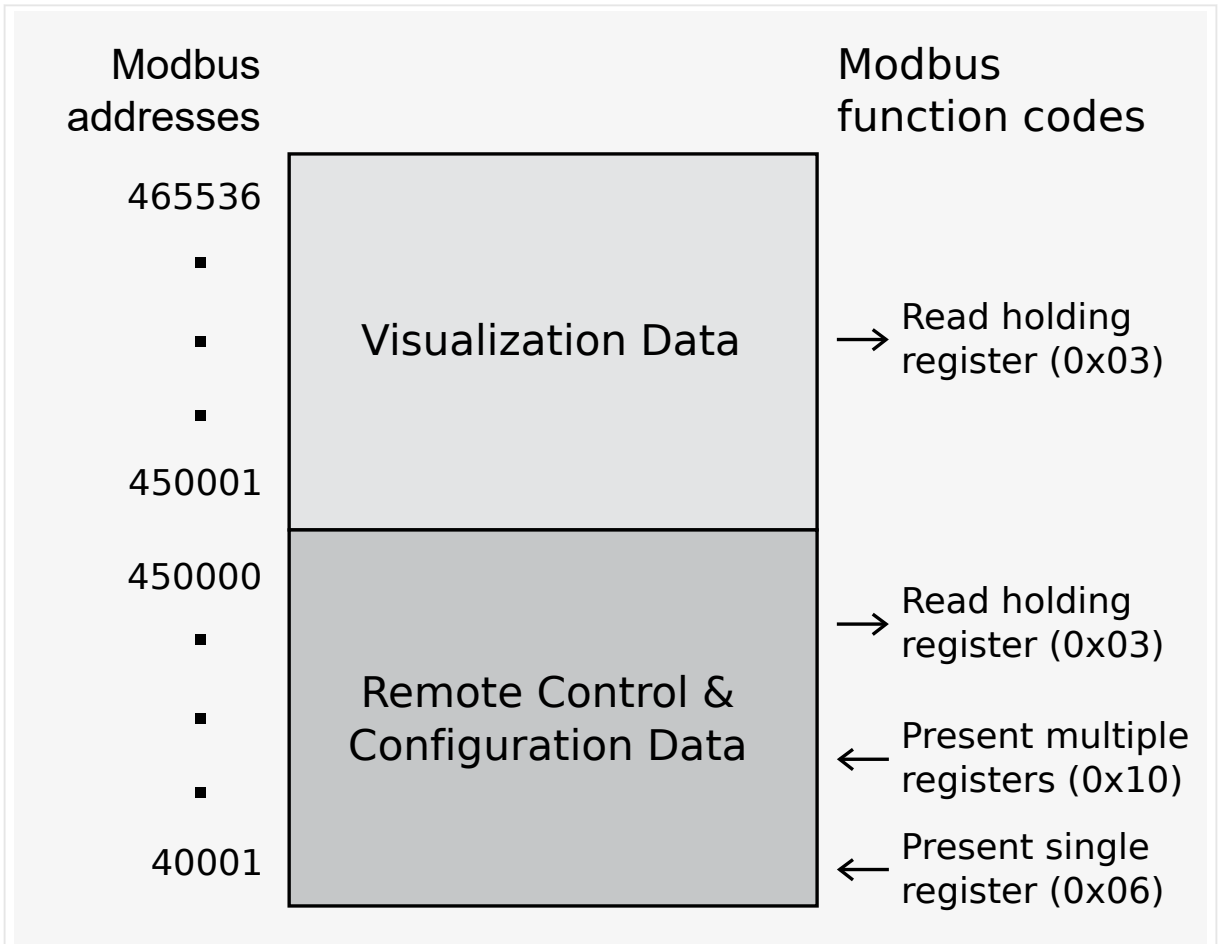

Fig. 394: Address range



All addresses in this document comply with the Modicon address convention. Some PLCs or PC programs use different address conventions depending on their implementation. Then the address must be increased and the leading 4 may be omitted.

Please refer to your PLC or program manual for more information. This determines the address sent over the bus in the Modbus telegram. The Modbus starting address 450001 of the visualization data may become bus address 50000 for example.

Visualization

The visualization over Modbus is provided in a very fast data protocol where important system data like alarm states, AC measurement data, switch states and various other information may be polled.

According to the Modbus addressing range, the visualization protocol can be reached on addresses starting at 450001. On this address range it is possible to do block reads from 1 up to 128 Modbus registers at a time.

Modbus read addresses	Description	Multiplier	Units
450001	Protocol-ID, always 5010		-

Modbus read addresses	Description	Multiplier	Units
450002	Scaling Power (16 bits) Exponent 10x W (5;4;3;2)		
.....
.....
450445	Total engine hours (j1939-HOURS)	1	h

Table 154: Address range block read



“4.7.3 Modbus Protocol” is only an excerpt of the data protocol. It conforms to the data protocol 5010.

The easYgen has an additional combined CANopen/Modbus protocol 5003.

Please refer to the Data Protocols chapter, “9.2 Data Protocols”

The following ModScan32 screenshot shows the configurations made to read the visualization protocol with a block read of 128 registers.

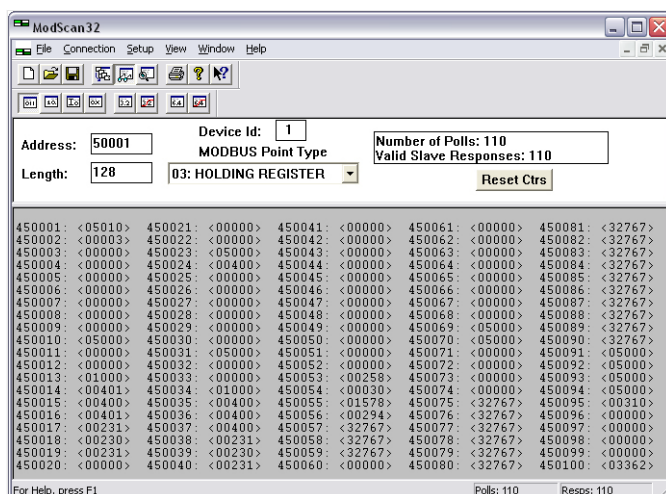

Fig. 395: Visualization configurations



Data Format(s)

Modbus registers are read and written according to the Modbus standard as Big-endian.

Composite data types like LOGMAN, ANALOGMANAGER, and TEXT use separate descriptions.

Configuration

The Modbus interface can be used to read/write parameters. According the Modbus addressing range for the configuration addresses, the range starts at 40001 and ends at 450000. You can always access only one parameter of the system in this address range. The Modbus address can be calculated depending on the parameter ID as illustrated below:

	Parameter ID < 10,000	Parameter ID >= 10,000
Modbus address =	40000 + (Par. ID+1)	400000 + (Par. ID+1)

Table 155: Address calculation

Block reads in this address range depend on the data type of the parameter. This makes it important to set the correct length in Modbus registers which depends on the data type (UNSIGNED 8, INTEGER 16, etc.).

Refer to [Table 156](#) for more information.

Types	Modbus registers	Remarks
UNSIGNED 8	1	
UNSIGNED 16	1	
INTEGER 16	1	
UNSIGNED 32	2	
INTEGER 32	2	
LOGMAN	7	Little-endian is used for LogicsManager to be compatible with (non-XT) easYgen series
ANALOGMANAGER	7	Big-endian is used for AnalogManager because it is the regular format for Modbus
TEXT/X	X/2	

Table 156: Data types



The Modbus RTU response time can increase under certain conditions (display versions / plastic housing only):

- **without** CAN (J1939 protocol) connected -> max. 2 seconds
- **with** CAN (J1939 protocol) connected -> max. 3 seconds



Woodward recommends to make a break time of 10 ms after receiving the data of the last Modbus request.

7.7 Load Sharing

General information

The maximum number of participating easYgen-3000XT Series devices for load sharing is 32. Both CAN and Ethernet interfaces can handle load share. Load share via Ethernet interface uses UDP broadcast messages.

(In the application mode "GCB/GC" **A13** the maximum number of participating easYgens in one group is restricted to 31 per group. Number 32 is used by the Group Controller.)

Multi-master principle

It is important to know that the load share and load-dependent start/stop functionality is subject to a multi-master principle. This means that there is no dedicated master and slave function. Each easYgen decides for itself how it has to behave.









The benefit is that there is no master control, which may cause a complete loss of this functionality in case it fails. Each control is also responsible for controlling common breakers like a mains circuit or generator group breaker.

Load share timeouts

The easYgen provides different timeout events to monitor a lost of loadshare messages. A lost of single loadshare messages may happen through bad connections, too much traffic on the bus or any other disturbances.

In general a timeout mark occurs if no load share message was received for a configured timeout. An according LogicsManager flag goes TRUE and a special entry can be activated in the Event History, see listed below. With parameter 2442 Load share timeout event set to OFF the timeout events will not show up in the Event History.

The timeout depends on the configured »Load share interface«  9924 and the related parameters, as follow:

- CAN: Timeout =  9921 *  9999
- ETHERNET A, B or B/C: Timeout =  7488 *  7489
- CAN/ETHERNET A: Max of ( 9921 *  9999) or ( 7488 *  7489)

Available timeout events:

- **easYgen LS timeout**

Occurs if no loadshare message is received for the configured timeout of any taught-in easYgen.

In the Event History "easYgen LS timeout" is shown with state True and the LogicsManager flag "08.78 easYgen LS timeout" is TRUE until the loadshare message is received again.

- **LSx LS timeout**

Occurs if no loadshare message is received for the configured timeout of any taught-in LSx.

In the Event History "LSx LS timeout" is shown with state True and the LogicsManager flag "08.79 LSx LS timeout" is TRUE until the loadshare message is received again.

- **Redundancy LS timeout**

Occurs if no loadshare message (of one of the redundant interfaces) is received for the configured timeout of any taught-in device.

In the Event History "Redund. LS timeout" is shown with state True and the LogicsManager flag "08.80 Redundancy LS timeout" is TRUE until the loadshare message is received again.

Load share monitoring

The easYgen provides Load Share / LDSS parameters for monitoring load sharing:

- **Multi-unit parameter alignment**

The multi-unit parameter alignment functionality requires that the relevant LDSS parameters are all configured identically at all participating units. For additional information refer to [↪ “4.5.6.17 Multi-Unit Parameter Alignment”](#).

- **Multi-unit missing member**

The multi-unit missing members monitoring function checks whether all participating units are available (sending data on the load share line).

The timeout depends on the configured "Load share Interface" ([↪ 9924](#)) and the related parameters, as follow:

ETHERNET A,B or B/C: Timeout = "Transmission rate"([↪ 7488](#)) multiplied with ["Timeout cycles"([↪ 7489](#)) + Timeout cycles data"([↪ 7497](#))]

CAN/ETHERNET A: Max of ("Transfer rate LS fast message" ([↪ 9921](#))) multiplied with "Load share timeout factor" ([↪ 9999](#)) or ("Transmission rate"([↪ 7488](#)) multiplied with "Timeout cycles"([↪ 7489](#)) + Timeout cycles data"([↪ 7497](#)))

- **Redundancy lost**

The Redundancy lost monitoring function checks whether all participating units are available (sending data on both load share lines CAN/ETH A or ETH B/C). For additional information refer to [↪ “4.5.6.22 Load Share Interface Redundancy is Lost”](#).

Load share communication

The following parameters allows to select the interface for load share communication. Refer to [↪ “4.4.4.3.5 Load-Share Interface”](#) for detailed information.

ID	Text	Setting range	Default value
9924	Load share Interface	CAN Off Ethernet A Ethernet B/C CAN/EthA by LM* CAN/Ethernet A Ethernet B	CAN
Notes * CAN or Ethernet A depending on ↪ 11986 (described below)			
11986	LS interface Ethernet A (LM 86.13: LS interf. EthA = 11987)	FALSE TRUE	FALSE
Notes			

ID	Text	Setting range	Default value
		Switches the load share interface between	
		<ul style="list-style-type: none"> • FALSE: CAN • TRUE: Ethernet A 	



Woodward recommends to configure the Node-IDs (parameter [↩️ 8950](#)) for units, which participate in load sharing, as low as possible to facilitate a fast establishing of communication.

7.7.1 Load Share via CAN

Bus load

The bus load increases with the number of units participating in load sharing.

The following parameters affect the bus load:

- Number of CAN participants
- Baud rate
- Transfer rate of load share messages
- Transfer rate of visualization protocols

We recommend to consider whether all data has to be sent on the CAN bus when planning the CAN bus. It is also possible to send visualization data via RS-485 for example.

Measures to reduce the bus load

If you need to reduce the bus load of the load share CAN bus, the following methods may be used:

- Increase the baud rate (parameter [↩️ 3156](#)) under consideration of the bus length (refer to [↩️ “3.4.4 CAN Bus Interfaces”](#)).
- Increase time of the transfer rate of the load share message (parameter [↩️ 9921](#)).
- Increase time of the transfer rate of the visualization message, i.e. the event timer (parameter [↩️ 9604](#)).
- Disable the transmission visualization data on the CAN bus and use the RS-485 interface to transmit visualization data.
- Disable SYNC message (parameter [↩️ 9100](#)) and/or TIME message (parameter [↩️ 9101](#)) and/or the producer heartbeat time SYNC message (parameter [↩️ 9120](#)), if possible.

CAN load share configuration

The following parameters are available for configuring the CAN bus interfaces. Refer to [↩️ “4.7.4.4 CAN Load Share Parameters”](#) for detailed information.

Open menu path [Parameter / Configuration / Configure interfaces / Configure CAN interfaces / Configure CAN load share]. Refer to [↳ “4.4.4.3.6 Load Sharing”](#).

ID	Text	Setting range	Default value
9921	Transfer rate LS fast message	0.10 to 0.30 s	0.10 s
9999	Load share timeout factor	2 to 20	2
9920	Load share CAN-ID	2xx Hex / 3xx Hex / 4xx Hex / 5xx Hex	5xx Hex

7.7.2 Load Share via UDP Broadcast Messages (Ethernet)

Load Share UDP

Load share and other system relevant messages are handled with UDP messages. The construction of the UDP messages allows (load share) communication with other Woodward devices.

For configuration of the Ethernet interface see chapters [↳ “4.7.5 Ethernet Interfaces”](#) and [↳ “7.2 Ethernet Interfaces”](#).

Additionally refer to [↳ “6.2.2.4 Tips for commissioning load share communication via Ethernet”](#) and [↳ “6.2.4 Ethernet Communication - General Measures to optimize bus load on easYgen devices”](#)

8 Technical Specifications

8.1 Technical Data

Product label

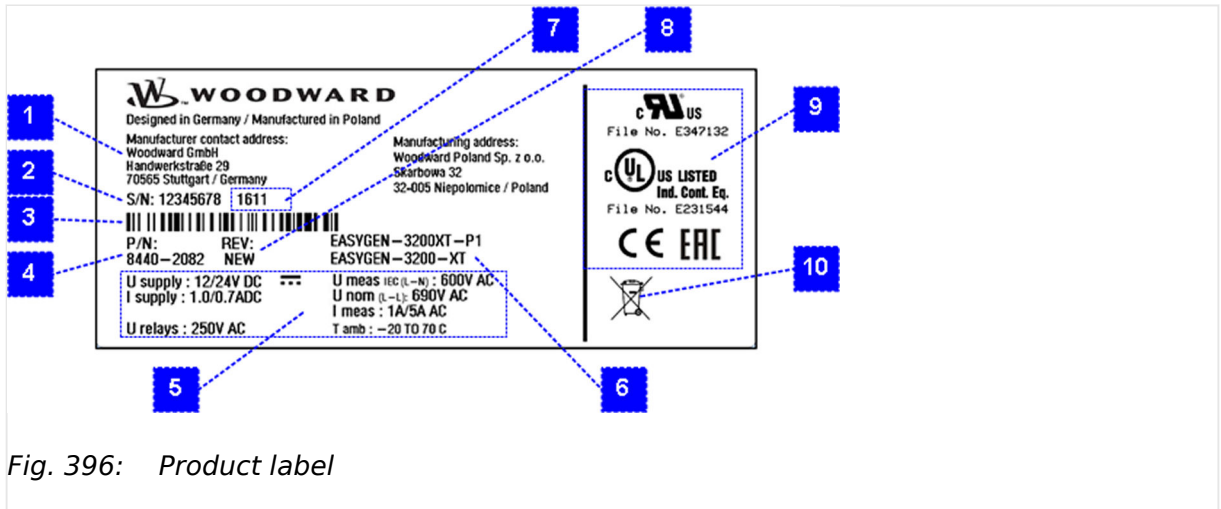

Fig. 396: Product label

Number	Name	Description
1	Address	Manufacturer and manufacturing addresses
2	S/N	Serial number (numerical)
3	S/N	Serial number (barcode)
4	P/N	Item number
5	Details	Technical data
6	Type Description	Description (product name)
7	S/N	Date of production (year-month)
8	REV	Item revision number
9	Approval	Approvals
10	Environment	Separate collection symbol

Battery inside



Fig. 397: Waste Disposal

This device contains a battery, and therefore it is labeled with the symbol shown beside according to the EU Directive 2006/66/EC.

WARNING!



Batteries can be harmful to the environment. Damaged or unusable batteries must be disposed of in a container specially reserved for this purpose.

In general, appropriate local guidelines and regulations must be followed when disposing of electrical devices and batteries.

8.1.1 Measuring Values

Voltages

Measuring values, voltages	
Measuring voltages \sphericalangle / Δ	398/690 V_{AC}
: Range rated value (V _{LLrated})	100 V _{AC} up to 690 V _{AC}
: Maximum value (V _{LLmax})	max. 897 V _{AC}
: Rated voltage phase - ground	600 V _{AC}
: Rated surge voltage	6.0 kV
Input resistance per path	2.5 M Ω
Maximum power consumption per path	< 0.15 W
Linear measuring range	1.3 × V _{rated}
Measuring frequency	50/60 Hz (30.0 to 85.0 Hz)

Currents



With External CT

For correct measuring with external CT the input has to be one side grounded by the customer.

Measuring values, currents		Galvanically isolated
Measuring current	Rated value (I _{rated})	../1 A or ../5 A
Linear measuring range	Generator	3.0 × I _{rated}
	Mains/ground current	approx. 1.5 × I _{rated}
Maximum power consumption per path		< 0.10 VA
Rated short-time current (1 s)		50.0 A

Battery Voltage

Measuring values, battery voltage	Galvanically isolated
Input voltage range	8 to 40 V _{DC}

8.1.2 Ambient Variables

CAUTION!



Device Operating Voltage

Connect the unit only to a DC power source that complies with the safety extra-low voltage (SELV) requirements.

Power supply	12/24 V _{DC} (8 to 40.0 V _{DC}), SELV
Intrinsic consumption	max. 32 W
Degree of pollution	2
Maximum elevation	4,000 m ASL
Insulation voltage	100 V _{DC} Marine applications: 40 V _{DC}
Overvoltage (≤ 2 min)	80 V _{DC}
Reverse voltage protection	Over the full supply range
Input capacitance	5,000 μF
Unit Power Supply	Negative potential grounded or positive potential grounded or ungrounded

8.1.3 Inputs/Outputs

Discrete inputs 'DI xx'

Discrete inputs	Galvanically isolated
Input range (V _{cont. dig. input})	Rated voltage 12/24 V _{DC} (8 to 40.0 V _{DC})
Input resistance	approx. 20 kΩ

Discrete outputs 'R xx' (relay outputs)

Discrete/relay outputs	Potential free Configurable via LogicsManager	Galvanically isolated
Contact material		AgNi
General purpose (GP) (V _{cont, relays})	AC	2.00 A _{AC} @250 V _{AC}
	DC	2.00 A _{DC} @24 V _{DC}
		0.36 A _{DC} @125 V _{DC} Not suitable for USA and Canada applications. Not evaluated by UL.
		0.18 A _{DC} @250 V _{DC}

		Not suitable for USA and Canada applications. Not evaluated by UL.
Pilot Duty	AC	B300

Sinking outputs (transistor outputs) 'SO xx'

CAUTION!



Additional external fuse recommended!

Protect your device by using a fast-acting fuses rated for 0.315 A compliant with IEC 60127 in an appropriate cartridge holder.

Sinking outputs	Galvanically isolated
Insulation voltage (continuously)	100 V _{AC/DC}
Insulation test voltage (1 s)	500 V _{AC}
Rated switching voltage	24 V _{DC}
Maximum switching voltage	40 V _{DC}
Maximum switching current	300 mA _{DC}

Analog inputs 'AI 01-03' (Type 1: 0/4 to 20 mA | 0 to 2000 Ω | 0 to 1 V)

Analog inputs	FlexIn™	Freely scalable
Maximum permissible voltage against Engine Ground		9 V
Maximum permissible voltage between Engine Ground & PE		100 V
Resolution		16 Bit
0/4 to 20 mA input	Internal load	~50 Ω
0 to 2000 Ω input	Load current	≤ 2.3 mA
0 to 1V input	Input resistance	approx. ~91 kΩ

Analog inputs 'AI 04-06' (Type 2: 0/4 to 20 mA | 0 to 10 V)

Analog inputs	FlexIn™	Freely scalable
Maximum permissible voltage against PE (Ground)		100 V
Resolution		14 Bit
0/4 to 20 mA input	Internal load	249 Ω
0 to 10 V input	Input resistance	approx. 80 kΩ

Analog inputs 'AI 07-10' (Type 3: 0 to 250 Ω | 0 to 2500 Ω)

Analog inputs	FlexIn™	Freely scalable
Maximum permissible voltage against PE (Ground)		100 V

Resolution		14 Bit
0 to 250 Ω input		0 to 250 Ω
0 to 2500 Ω input		0 to 2500 Ω

Analog outputs 'AO 01' "Speed Biasing" (Type 1: ± 20 mA | ± 10 V | PWM)

Analog output	Freely scalable Pre-configured to "11.03 Speed bias [%]"	Galvanically isolated
Resolution		min. 12 bit
Configurable as	(bipolar)	± 20 mA, ± 10 V _{DC}
PWM output		± 10 V _{DC} , 500 Hz duty cycle
Shunt resistor		max. 500 Ω
Galvanically isolation to PE		min. 100 V _{AC}

Analog outputs 'AO 02' "Voltage Biasing" (Type 1: ± 20 mA | ± 10 V | PWM)

Analog output	Freely scalable Pre-configured to "11.02 Voltage bias [%]"	Galvanically isolated
Resolution		min. 12 bit
Configurable as	(bipolar)	± 20 mA, ± 10 V _{DC}
PWM output		± 10 V _{DC} , 500 Hz duty cycle
Shunt resistor		max. 500 Ω
Basic isolation to PE		500 V _{RMS}
Reinforced isolation to PE		300 V _{RMS}

Analog outputs 'AO 03-06' (0/4 to 20 mA)

Analog outputs		Galvanically isolated
At rated output		Freely scalable
Insulation voltage (continuously)		100 V _{AC}
Insulation test voltage (1 s)		500 V _{AC}
Versions		0 to 20 mA
Resolution	Configured to 0 to 20 mA	12 bit
0 to 20 mA output	Load	≤ 500 Ω

Auxiliary excitation (D+) input/output

Auxiliary excitation (D+) input/output	Galvanically isolated
Output current	approx. 100 mA@12/24 V _{DC}

Voltage monitoring range (input)	8 to 40 V _{DC}
----------------------------------	-------------------------

Magnetic pickup input (MPU)

Magnetic pickup input	Capacitively isolated
Input impedance	min. 17 kΩ (decoupled by capacitors)
Voltage range (input)	800 mV _{pp} to 100 V _{pp} Refer to Fig. 398
Proximity Probe Leakage Current	≤100 μA
Response time (max. unloaded engine acceleration)	≤1000 rpm per second
Minimum rated rpm	100 (rpm)

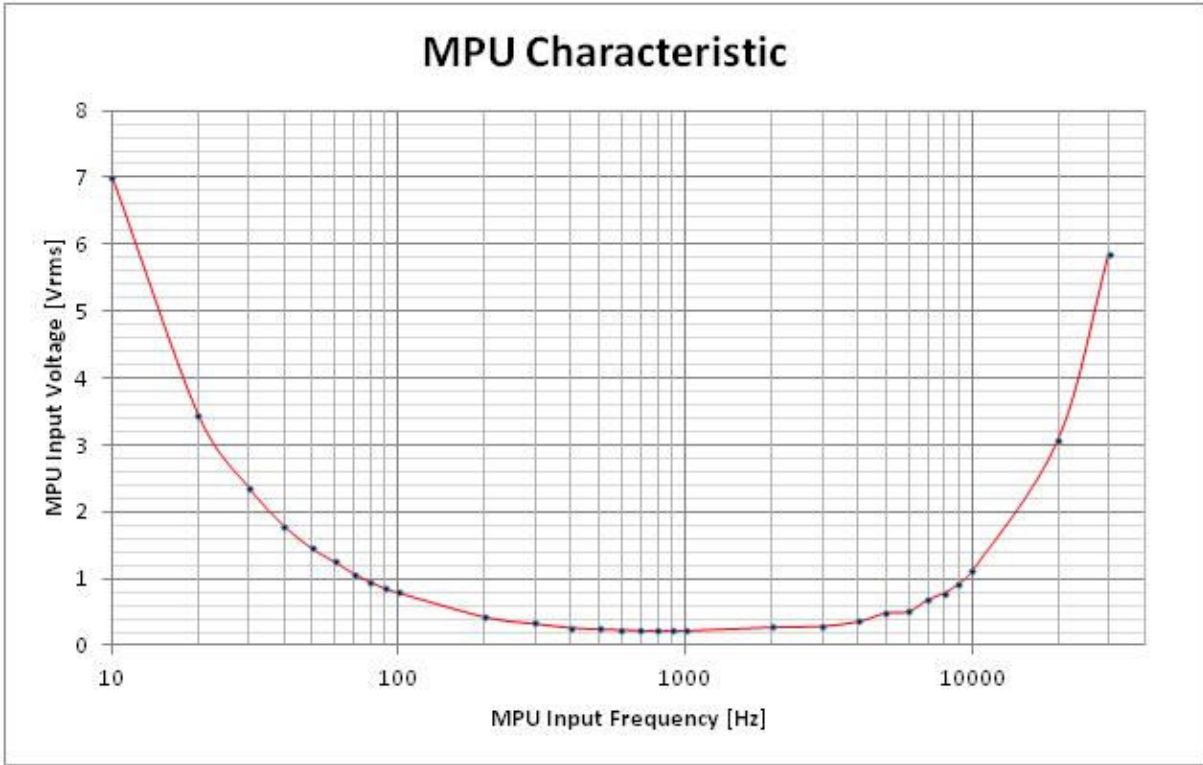

Fig. 398: MPU - characteristic

8.1.4 Interfaces

USB (slave)

USB 2.0 interface	Galvanically isolated
Type	USB 2.0 standard; slave (Type B)
Data rate	max. 12 Mbit/s

Insulation	Galvanically isolated
Bus Voltage	5 V
Current consumption	approx. 10 mA

RS-485 interface

RS-485 interface	Galvanically isolated
Insulation voltage (continuously)	100 V _{AC}
Insulation test voltage (1 s)	1700 V _{DC}
Version	RS-485 Standard

CAN bus interface

CAN bus interface	Galvanically isolated
Insulation voltage (continuously)	100 V _{AC}
Insulation test voltage (1 s)	1700 V _{DC}
Version	CAN bus
Internal line termination	Not available

Ethernet interface

Ethernet bus interface	Galvanically isolated Only one MAC ID is required
Insulation voltage (continuously)	100 V _{AC}
Insulation test voltage (1 s)	1700 V _{DC}
Version	Ethernet 10/100Base-T/TX
Ethernet plug socket	RJ45 standard, shielded 2 LEDs to indicate communication.
Ethernet cable	CAT 5 or 5e (class D) Shielding: F/UTP according to ISO/IEC 11801 (foil overall shielding, pairs unshielded)
Green LED	Indicates link activity (blinking during data transmission)
Yellow LED	Indicates link status (regarding speed): 10 Mb/s: LED switched-off 100 Mb/s: LED switched-on
Internal shield termination	Available

8.1.5 Real Time Clock Battery

Type	Lithium
Life span (operation without power supply)	approx. 5 years
Battery field replacement	Not allowed. Please contact your Woodward service partner.

8.1.6 Display (plastic housing variant, only)

Type	LCD display
Size	Diagonal: 5,7" (144.8 mm)
Resolution	320 x 240 pixel
Picture quality	up to 8 bad dots allowed
Backlight luminance	550 cd/m ² (max)
Temperature threshold (Heater ON/OFF)	-20 °C ambient (for "...-LT" variants, only)

8.1.7 Housing

Housing type

Type	Plastic	Sheet metal
	easYpack	Custom
Dimensions (W × H × D)	282 × 216 × 98.2 mm	250 × 227 × 84 mm
Front cutout (W × H)	249 [+1.1] × 183 [+1.0] mm	-/-
Weight	approx. 2560 g	approx. 2480 g
Wiring	Screw-plug-terminals 2.5 mm ²	
Recommended locked torque	4 inch pounds / 0.5 Nm. Use 90 °C copper wire or better. Use class 1 wire only or equivalent.	

Protection

Protection system	Plastic	Sheet metal
		IP54 in the front with clamp fasteners
		IP66 in the front with screw kit
		IP20 on the rear side
	Sheet metal	IP20

Front foil (plastic housing)		Insulating surface
------------------------------	--	--------------------

8.1.8 Approvals

EMC test (CE)	Tested according to applicable EMC standards. Refer to ↪ “8.2 Environmental Data” for details	
Listings	CE marking UL, Ordinary Locations, File No.: E231544 UL recognized component, category FTPM2/8, File No.: E347132 cUL CSA EAC BDEW (Dynamic mains stabilization) VDE-AR-N 4105 (Mains decoupling and single failure proof feature)	
Marine	Type approval	Lloyds Register (LR)
	Type approval	American Bureau of Shipping (ABS)

8.2 Environmental Data

Vibration

Frequency range - sine sweep	5 Hz to 100 Hz
Acceleration	4 G
Standards	IEC 60068-2-6, Fc
	Lloyd's Register, Vibration Test2
	SAEJ1455 Chassis Data
Frequency range - random	10 Hz to 2000 Hz
Power intensity	0.04 G ² /Hz
RMS value	8.2 Grms
Standards	MIL-STD 202F, M214A, SAE J1455

Shock

Shock	40 G, Saw tooth pulse, 11 ms
Standards	MIL-STD 810F, M516.5, Procedure 1

Temperature

Housing type			»...-LT« version, only
Plastic	Cold, Dry Heat (storage)	-30 °C (-22 °F) / 80 °C (176 °F)	-30 °C (-22 °F) / 80 °C (176 °F)

	Cold, Dry Heat (operating)	-20 °C (-4 °F) / 70 °C (158 °F)	-40 °C (-40 °F) / 70 °C (158 °F)
Sheet metal	Cold, Dry Heat (storage)	-40 °C (-40 °F) / 80 °C (176 °F)	
	Cold, Dry Heat (operating)	-40 °C (-40 °F) / 70 °C (158 °F)	
Standards	IEC 60068-2-2, Test Bb and Bd		
	IEC 60068-2-1, Test Ab and Ad		

Humidity

Humidity	60 °C, 95% RH, 5 days
Standards	IEC 60068-2-30, Test Db

Marine environmental categories

Marine environmental categories	Lloyd's Register of Shipping (LRS): ENV1, ENV2, ENV3 and ENV4
---------------------------------	--

Electromagnetic Compatibility

EN 61000-6-2	2005 - Electromagnetic compatibility (EMC). Generic standards. Immunity for industrial environment
EN 61000-6-4	2007 + A1: 2011 - Electromagnetic compatibility (EMC). Generic standards. Emission standard for industrial environments
EN 61326-1	2013 - Electrical equipment for measurement, control and laboratory use. EMC requirements. General requirements (according to industrial electromagnetic environment)

8.3 Accuracy

The accuracy declaration is defined by the according measurement ranges. The rated maximum of the single ranges are taken as 100%.

This results in the definitions:

- Range 1: 69/120 V rated = 100%
- Range 2: 277/480 V rated = 100%
- Range 3: 400/690 V rated = 100%

Measuring value	Display	Accuracy	Measuring start	Notes
Frequency				
Generator	15.0 to 85.0 Hz	0.1% (of 85 Hz)	5% (of PT secondary voltage setting) ¹	
Mains	30.0 to 85.0 Hz			

Measuring value	Display	Accuracy	Measuring start	Notes
Voltage				
Wye generator / mains / busbar	0 to 650 kV	0.5% , Class 0.5 ² related to:	1.5% (of PT secondary voltage setting) ¹	
Delta generator / mains / busbar		69/277/400 V (Wye) 120/480/690 V (Delta)	2% (of PT secondary voltage setting) ¹	
Power supply/Battery	0 to 40 V _{DC}	±0.5% related to 40 V	Related on the measurement range 8 to 40 V	0.5% equals 0.2 V (±0.2 V)
Current				
Generator	0 to 32,000 A	0.5%	1% (of 1.3/6.5 A) ³	
Max. value		(of 1/5 A) ³ Class 0.5		
Mains/ground current				
Real power				
Actual total real power value	-2 to 2 GW	1% (of 69/277/400 V x 1/5 A) ^{2/3}	Measuring starts with detecting the zero passage of current/voltage	
Reactive power				
Actual value in L1, L2, L3	-2 to 2 Gvar	1% (of 69/277/400 V x 1/5 A) ^{2/3}	Measuring starts with detecting the zero passage of current/voltage	
Power factor				
Actual value power factor L1	lagging 0.000 to 1.000 to leading 0.000	1%	1% (of 1.3/6.5 A) ³	1.000 is displayed for measuring values below the measuring start
Miscellaneous				
Real energy	0 to 4,200 GWh		0.36% (of 1.3/6.5 A) ³	Not calibrated
Operating hours	Max. 1 × 10 ⁶ h			
Maintenance call hours	0 to 9,999 h			
Maintenance call days	0 to 999 d			
(Engine) Start counter	0 to 65,535			
Battery voltage	8 to 40 V	±0.5% (of measurement range 0 to 40 V _{DC})		
Auxiliary excitation (D+) input/output		1%		
Pickup speed	f _{rated} +/- 40%	0,1% of f _{rated} +/- 1 rpm		
Phase angle	-180 to 180°	± 1 degree	1.25% (of PT secondary volt. setting)	180° is displayed for measuring values

Measuring value	Display	Accuracy	Measuring start	Notes
				below measuring start
Analog Inputs				
0 to 20 mA	Freely scalable	±0.5% related to 20 mA		2 wire input. 0.5% equals 0.1 mA ⇒ ± 0.1 mA)
0 to 2000 Ω	Freely scalable	±0.5% related to 2000 Ω		1 wire input (related to engine ground) ⁴
0 to 1 V	Freely scalable	±0.5% related to 1 V		2 wire input. 0.5% equals 0.005 V ⇒ ± 0.005 V)
0 to 10 V	Freely scalable	±0.5% related to 10 V		2 wire input. 0.5% equals 0.05 V ⇒ ± 0.05 V)
0 to 250 Ω	Freely scalable	±0.5% related to 250 Ω		3 wire input. 0.5% equals 1.25 Ω ⇒ ± ±1.25 Ω
0 to 2500 Ω	Freely scalable	±0.5% related to 2500 Ω		3 wire input. 0.5% equals 12.5 Ω ⇒ ±12.5 Ω
Analog Outputs				
Type 1: ±20 mA ±10 V PWM	Freely scalable	≤1%		
Type 2: 0 to 20 mA 4 to 20 mA	Freely scalable	≤0.5%		



¹ Setting of the parameter for the PT secondary rated voltage

² Depending on the used measuring range (120/480/690 V)

³ Depending on the CT input definition (1/5 A) by customer settings. easYgen-XT hardware covers both 1 A and 5 A ranges.

⁴ Some senders, like the VDO senders, are operating in the working range 0 to 200 Ohms. For sure, the 0.5% accuracy cannot be directly assigned to these senders. Therefore the accuracy percentage tolerance will be expanded accordingly. On the other hand, measurements have shown that under usual circumstances (at 20°C, no EMC surge or burst present) an accuracy of 1% for such senders can be kept.

Reference conditions



The reference conditions for measuring the accuracy are listed below.

Input voltage	Sinusoidal rated voltage
Input current	Sinusoidal rated current
Frequency	Rated frequency
Power supply	Rated voltage \pm 2%
Power factor (cos ϕ)	1.000
Ambient temperature	23 °C \pm 2 K
Warm-up period	20 minutes

8.4 Protection (ANSI)

"ANSI Code" related Protection Functions

Protection		related ANSI #
Generator:	Voltage / frequency	59 / 27 / 81O / 81U
	Overload, reverse/reduced power	32 / 32R / 32F
	Unbalanced load	46
	Synch Check	25
	Instantaneous overcurrent	50
	Time-overcurrent (IEC 255 compliant)	51 / 51 V
	Ground fault (measured ground current)	50G
	Power factor	55
	Rotation field	
Engine:	Overspeed / underspeed	12 / 14
	Speed / frequency mismatch	
	D+ auxiliary excitation failure	
	Cylinder temperature	
Mains:	Voltage / frequency	59 / 27 / 81O / 81U / 25
	Phase shift / rotation field / ROCOF (df/dt)	78
Busbar	Voltage	
	Frequency	

9 Appendix

9.1 Characteristics

9.1.1 Triggering Characteristics

Time-dependent overshoot monitoring

This triggering characteristic is used for time-dependent overcurrent monitoring.

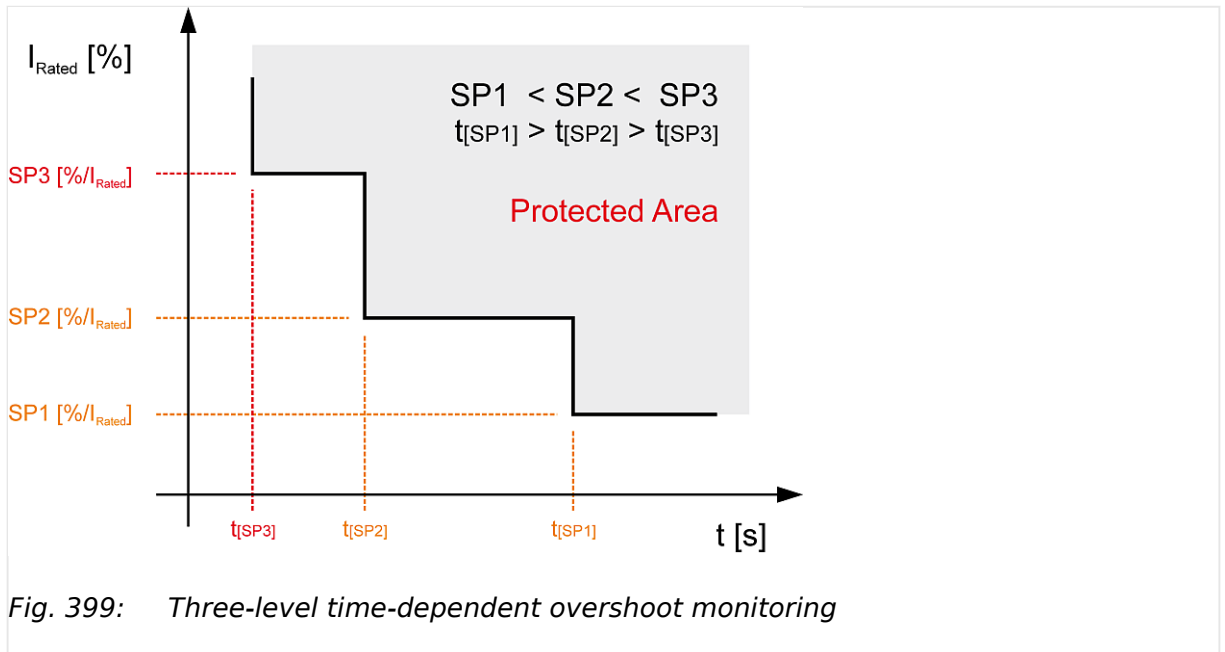

Fig. 399: Three-level time-dependent overshoot monitoring

Two-level overshoot monitoring

This triggering characteristic is used for generator, mains and battery overvoltage, generator and mains overfrequency, overload IOP and MOP and engine overspeed monitoring.

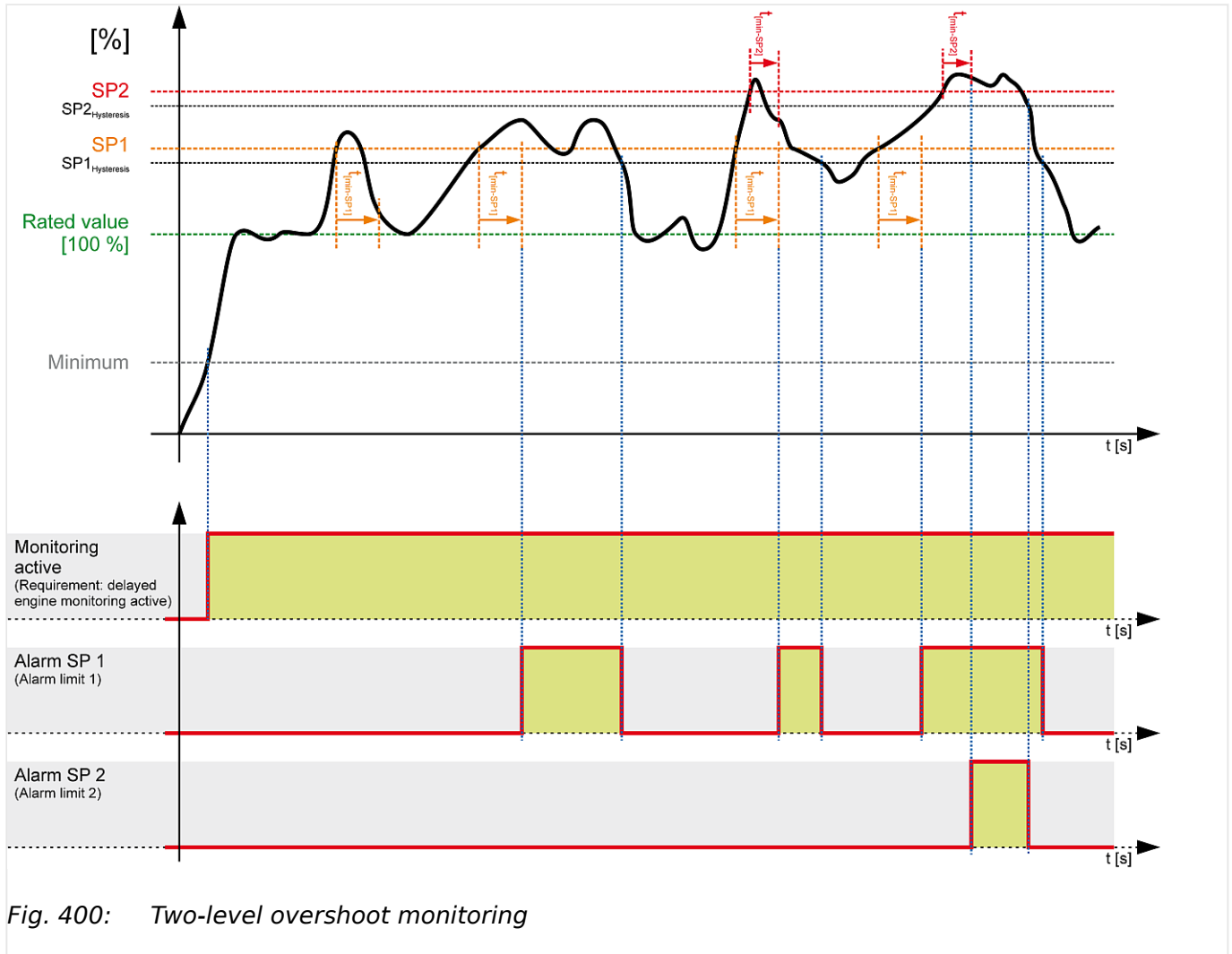

Fig. 400: Two-level overshoot monitoring

Two-level undershoot monitoring

This triggering characteristic is used for generator, mains and battery undervoltage, generator and mains underfrequency, and engine underspeed monitoring.

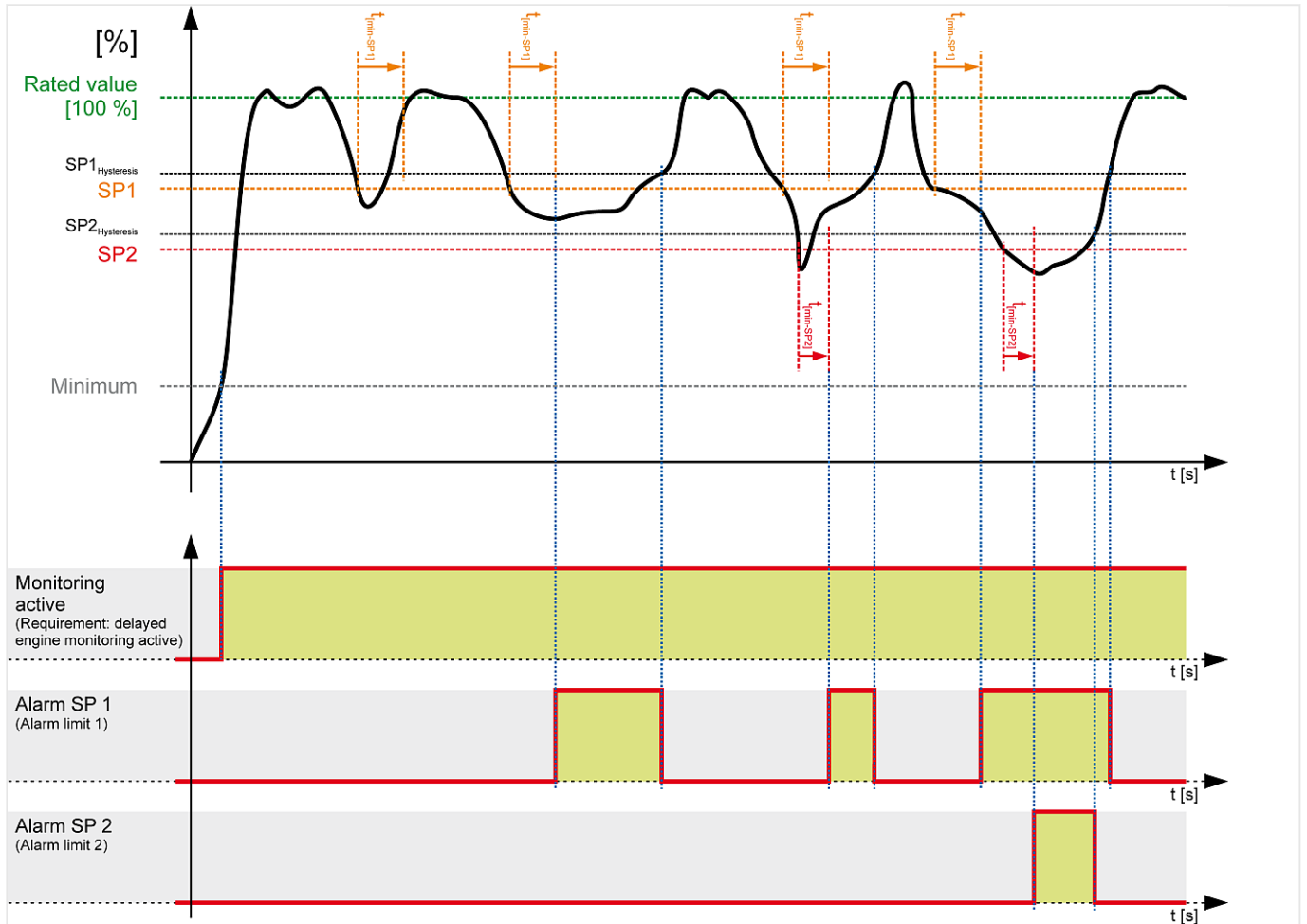

Fig. 401: Two-level undershoot monitoring

Two-level reversed/reduced load monitoring

This triggering characteristic is used for generator reversed/reduced load monitoring.

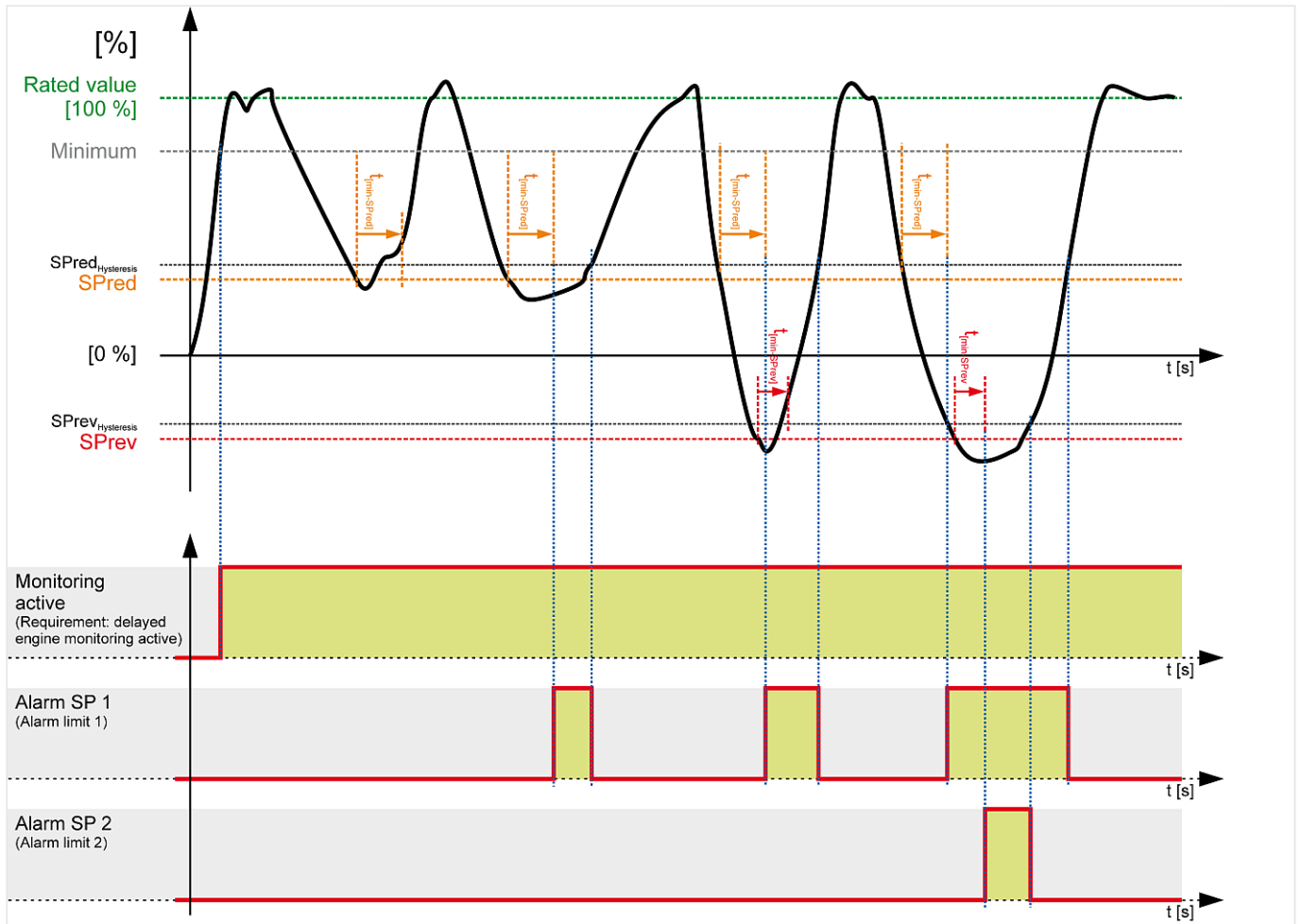

Fig. 402: Two-level reversed/reduced load monitoring

Two-level unbalanced load monitoring

This triggering characteristic is used for generator unbalanced load monitoring.

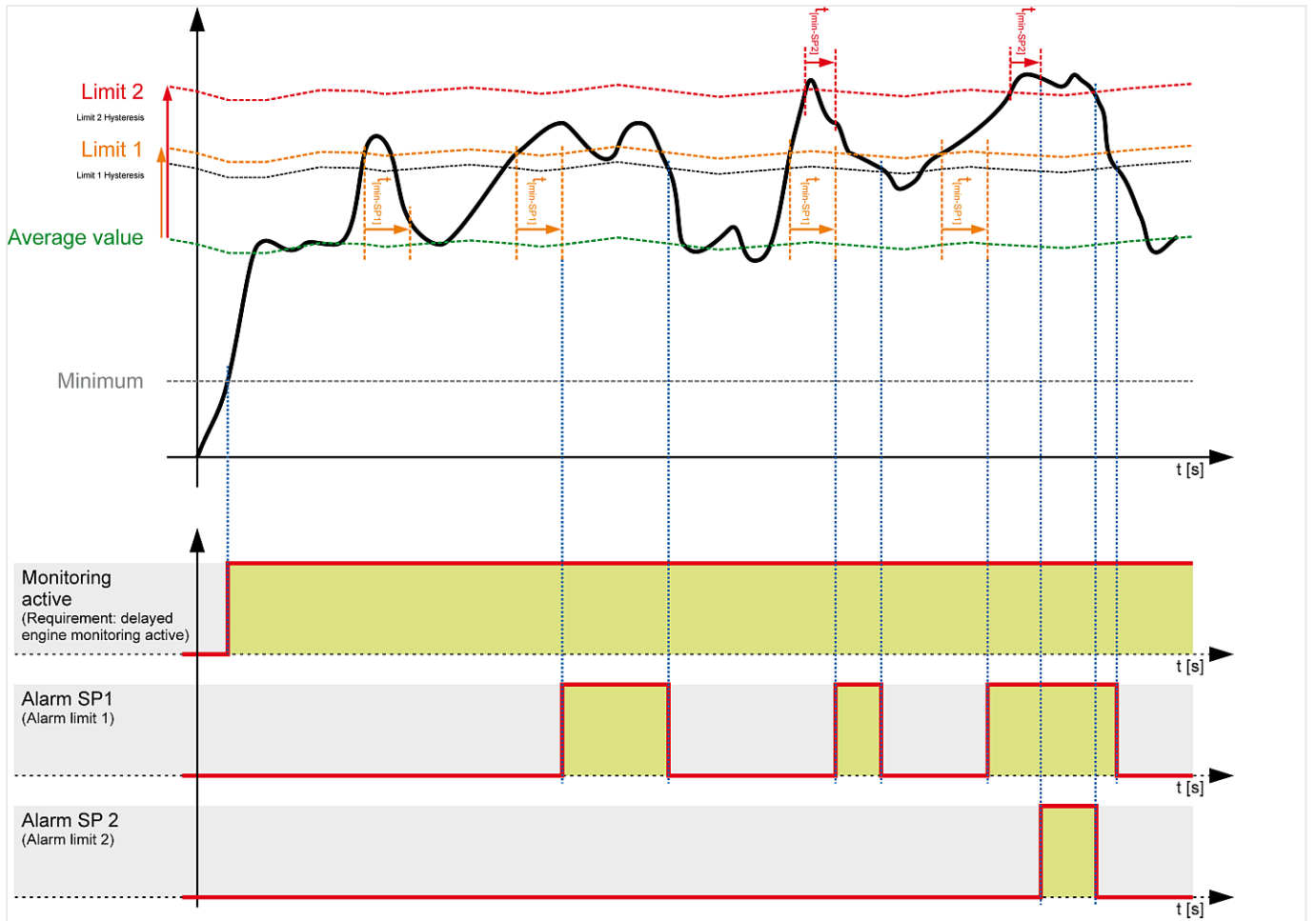

Fig. 403: Two-level unbalanced load monitoring

One-level asymmetry monitoring

This triggering characteristic is used for generator voltage asymmetry monitoring.

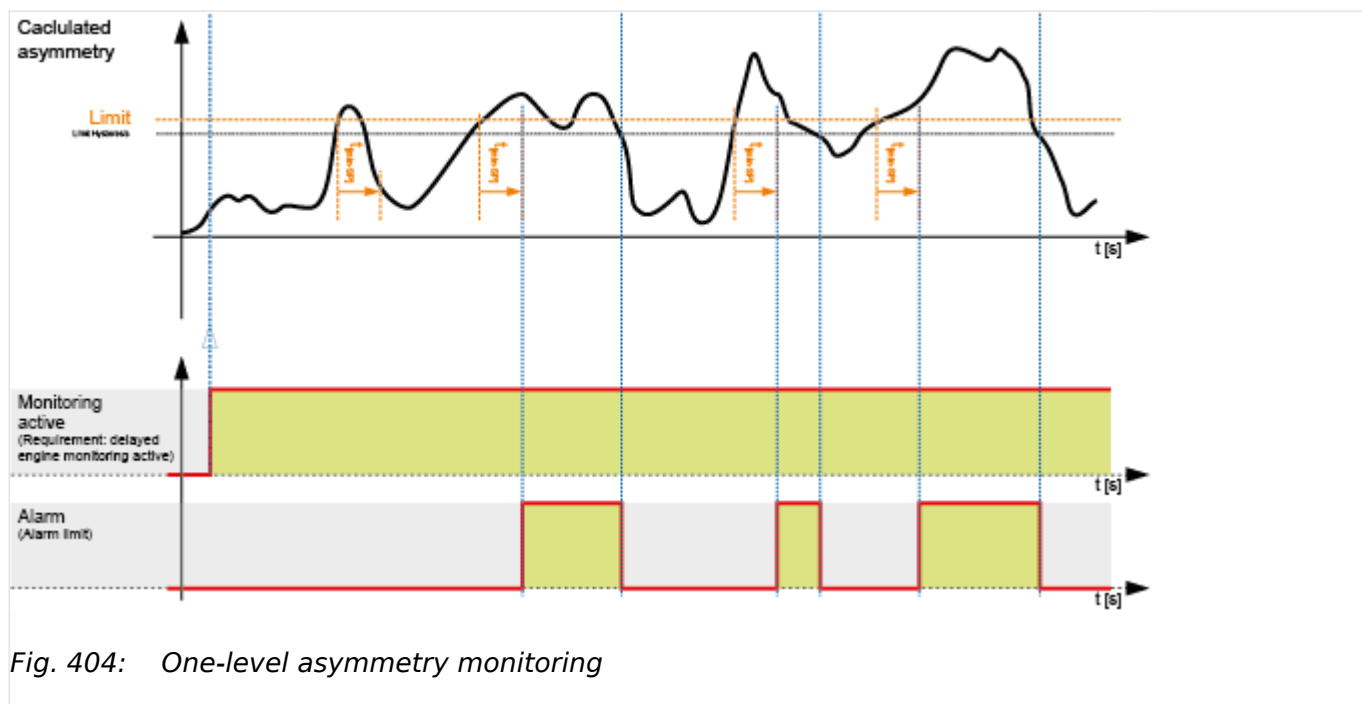

Fig. 404: One-level asymmetry monitoring

9.1.2 VDO Inputs Characteristics

Since VDO sensors are available in different types, the index numbers of the characteristic curve tables are listed.



1. ▷ Always order VDO sensors with the correct characteristic curve. Manufacturers of VDO sensors usually list these tables in their catalogs.

9.1.2.1 VDO Input "Pressure"

0 to 5 bar/0 to 72 psi - Index "III"

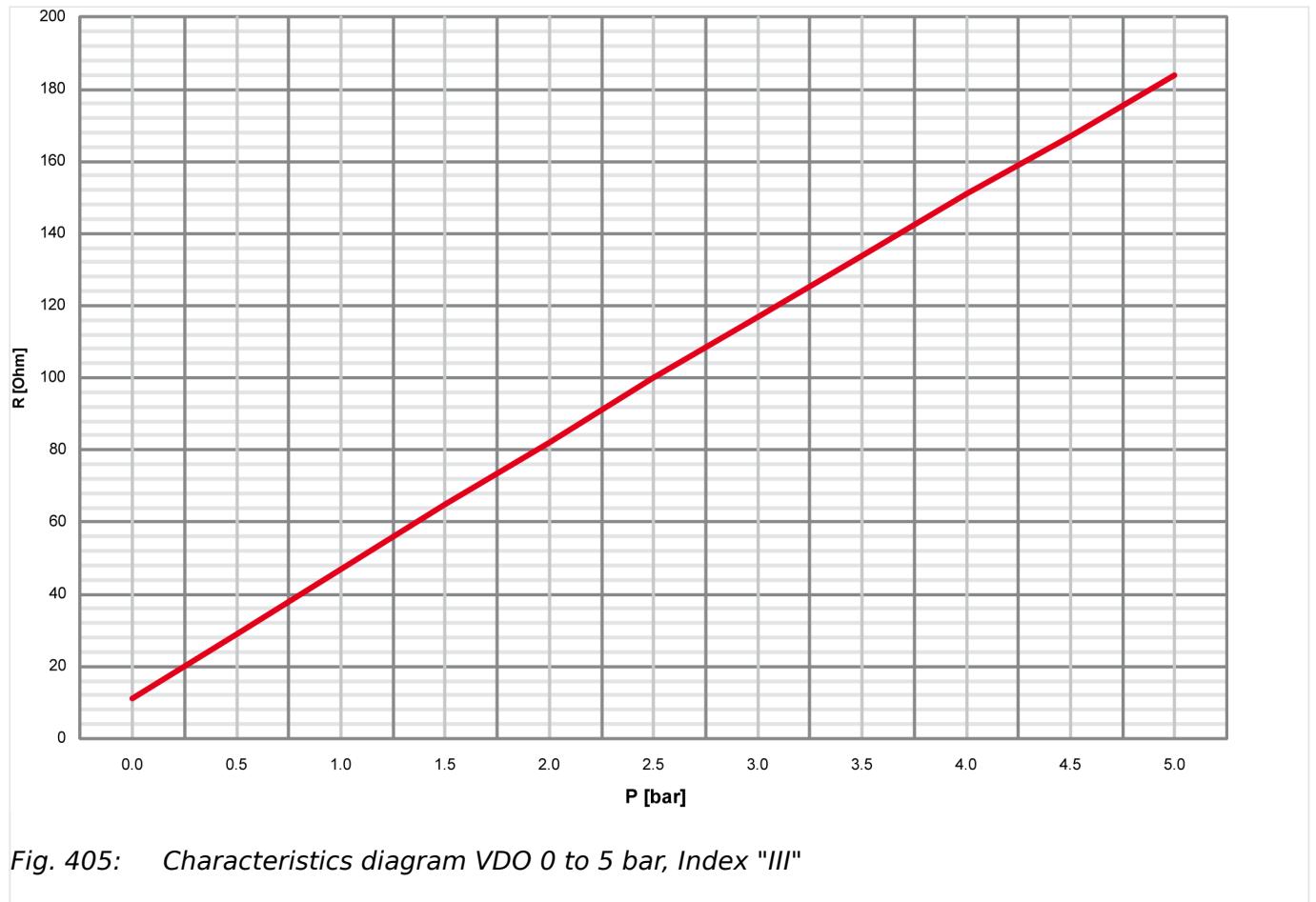

Fig. 405: Characteristics diagram VDO 0 to 5 bar, Index "III"

P [bar]	0	0.5	1	1.5	2	2.5	3	3.5	4	4.5	5
P [psi]	0	7.25	14.50	21.76	29.00	36.26	43.51	50.76	58.02	65.27	72.52
R [Ohm]	11	29	47	65	82	100	117	134	151	167	184

0 to 10 bar/0 to 145 psi - Index "IV"

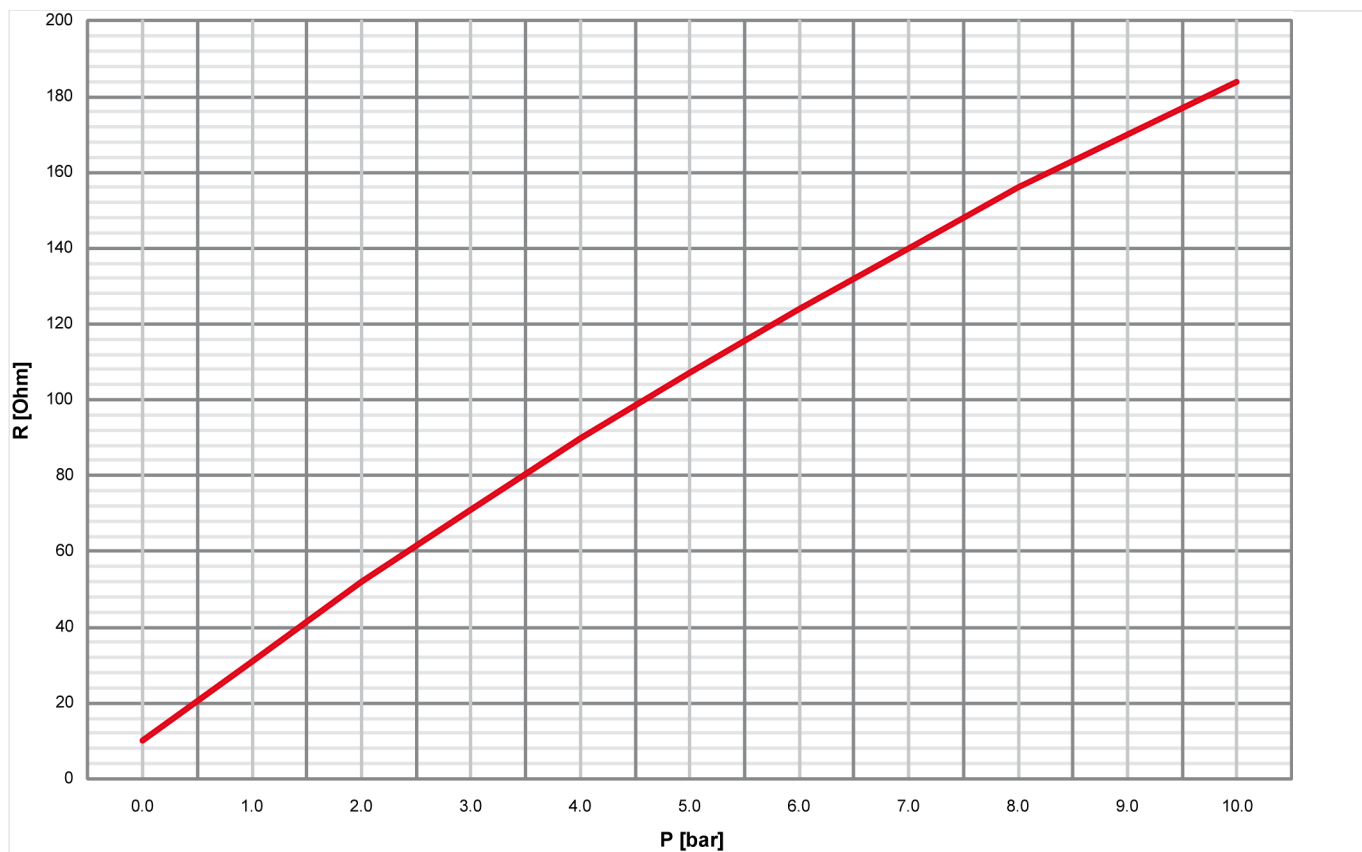

Fig. 406: Characteristics diagram VDO 0 to 10 bar, Index "IV"

P [bar]	0	0.5	1	1.5	2	3	4	5	6	7	8	8.5	9	10
P [psi]	0	7.25	14.50	21.76	29.00	43.51	58.02	72.52	87.02	101.53	116.03	123.28	130.53	145.04
R [Ohm]	10	21	31	42	52	71	90	107	124	140	156	163	170	184

9.1.2.2 VDO Input "Temperature"

40 to 120 °C/104 to 248 °F - Index "92-027-004"

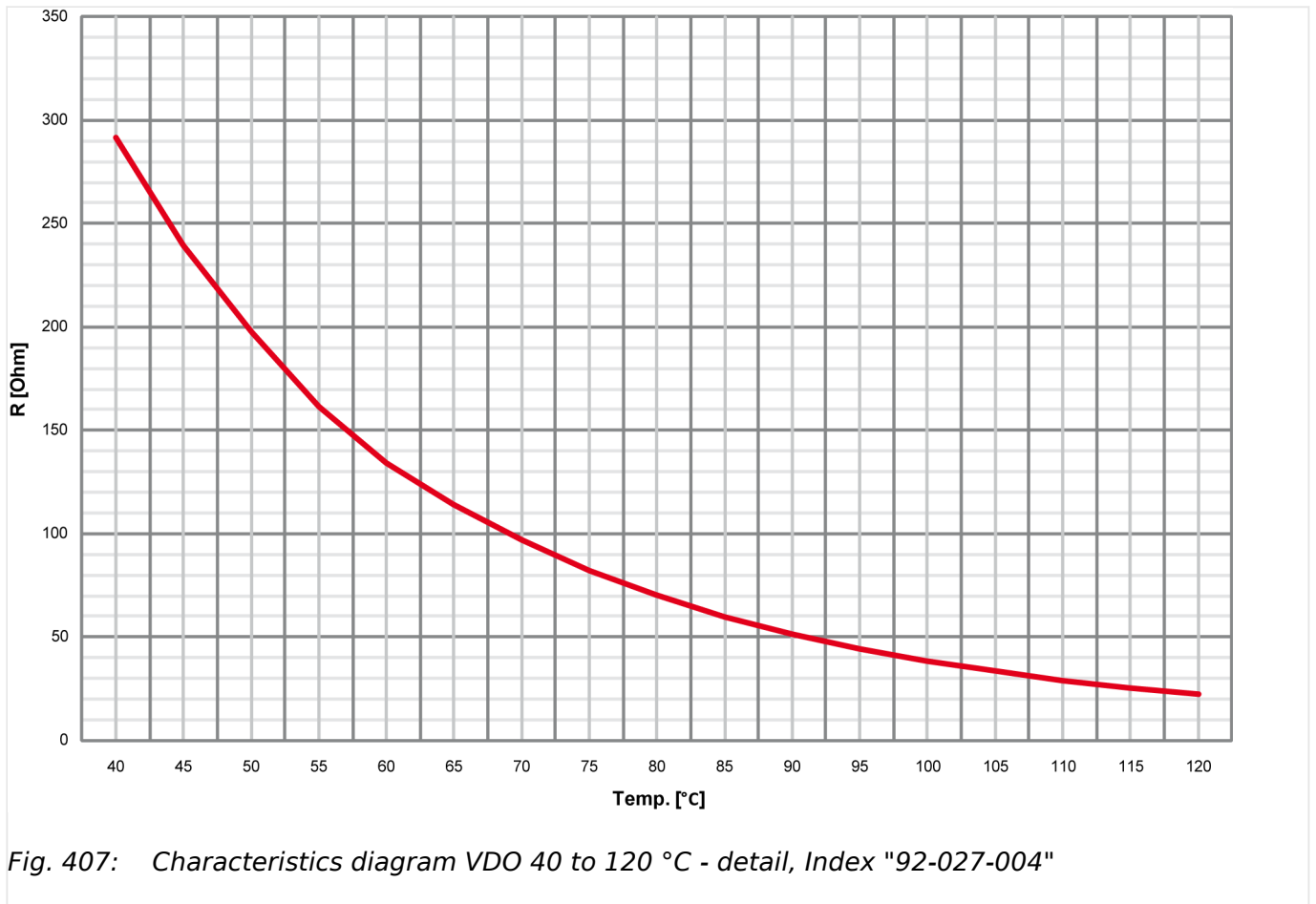

Fig. 407: Characteristics diagram VDO 40 to 120 °C - detail, Index "92-027-004"

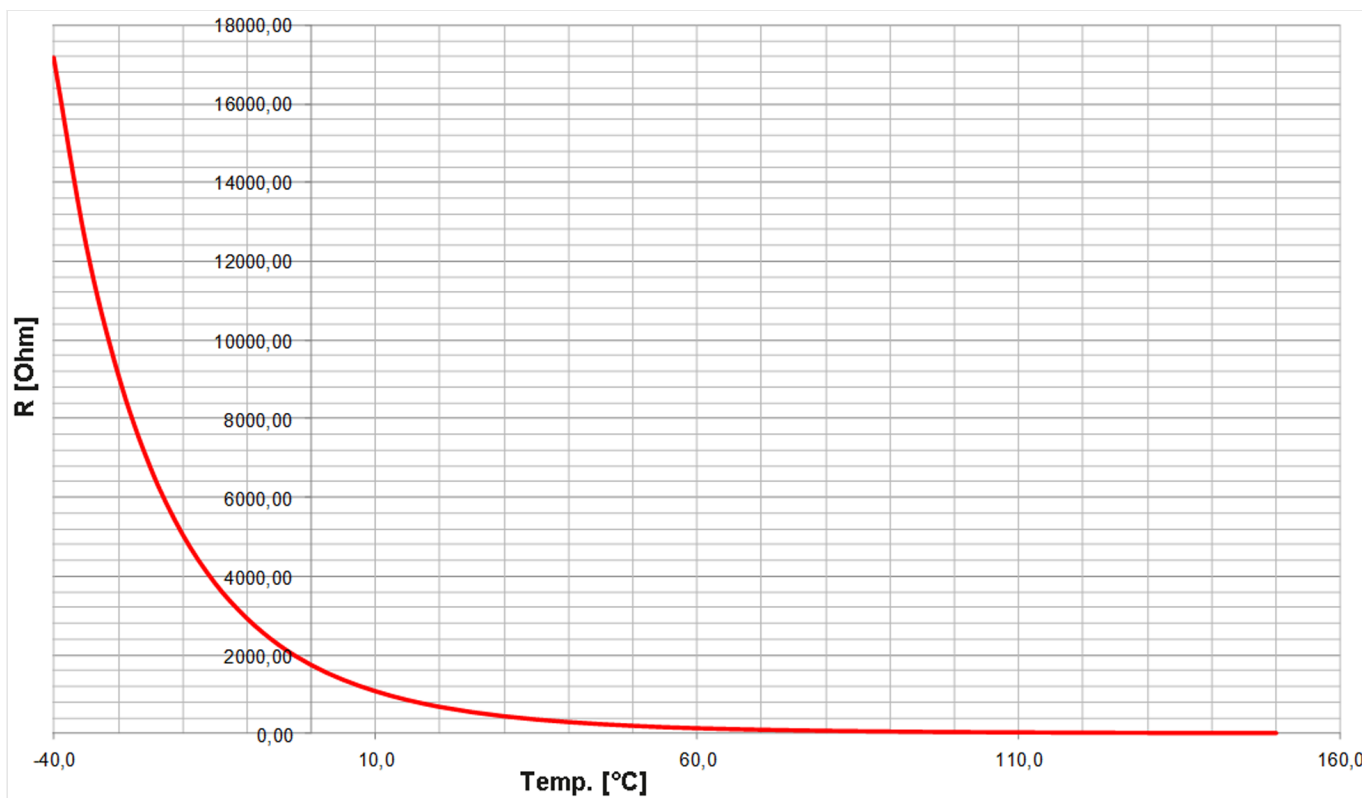

Fig. 408: Characteristics diagram VDO -40 to 120 °C - full range, Index "92-027-004"

Temp. [°C]	-40	-35	-30	-25	-20	-15	-10	-5	0	5	10
Temp. [°F]	-40	-31	-22	-13	-4	5	14	23	32	41	50
R [Ohm]	17162.4	12439.5	9134.5	6764.5	5067.6	3833.9	2929.9	2249.4	1743.1	1364.0	1075.6
... continued with further points:											
Temp. [°C]	15	20	25	30	35	40	45	50	55	60	65
Temp. [°F]	59	68	77	86	95	104	113	122	131	140	149
R [Ohm]	850.1	677.0	543.5	439.3	356.6	291.5	239.6	197.3	161.5	134.0	114.0
... continued with further points:											
Temp. [°C]	70	75	80	85	90	95	100	105	110	115	120
Temp. [°F]	158	167	176	185	194	203	212	221	230	239	248
R [Ohm]	97.1	82.4	70.1	59.7	51.2	44.3	38.5	33.4	29.1	25.5	22.4
... and finally continued with further points:											
Temp. [°C]	125	130	135	140	145	150					
Temp. [°F]	257	266	275	284	293	302					

9 Appendix

9.1.2.2 VDO Input "Temperature"

R [Ohm]	19.75	17.44	15.46	13.75	12.26	10.96					
---------	-------	-------	-------	-------	-------	-------	--	--	--	--	--

50 to 150 °C/122 to 302 °F - Index "92-027-006"

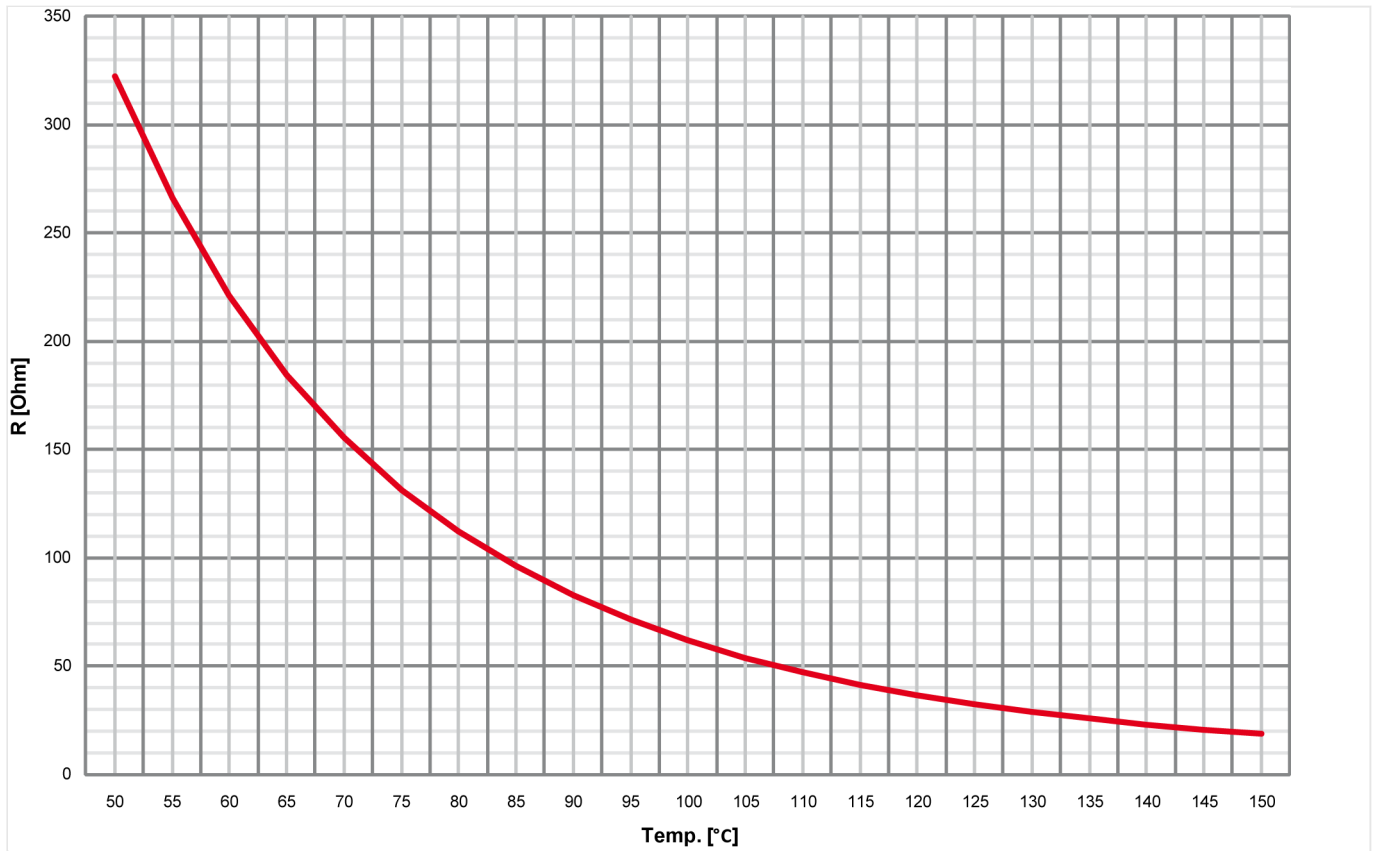

Fig. 409: Characteristics diagram VDO 50 to 150 °C - detail, Index "92-027-006"

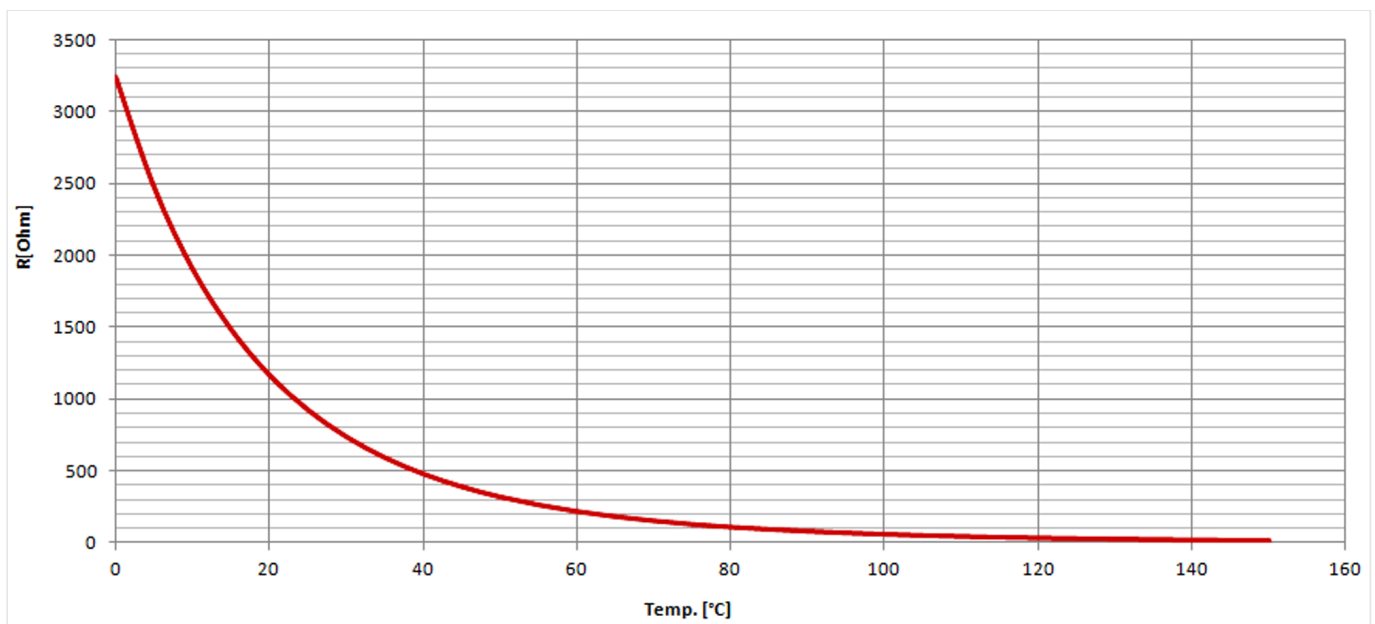

Fig. 410: Characteristics diagram VDO 0 to 120 °C - full range, Index "92-027-006"

Temp. [°C]	0	5	10	15	20	25	30	35	40	45	50
Temp. [°F]	32	41	50	59	68	77	86	95	104	113	122
R [Ohm]	3240.18	2743.6	1905.87	1486.65	1168.64	926.71	739.98	594.9	481.53	392.57	322.17

Temp. [°C]	55	60	65	70	75	80	85	90	95	100	105
Temp. [°F]	131	140	149	158	167	176	185	194	203	212	221
R [Ohm]	266.19	221.17	184.72	155.29	131.38	112.08	96.40	82.96	71.44	61.92	54.01

Temp. [°C]	110	115	120	125	130	135	140	145	150	
Temp. [°F]	230	239	248	257	266	275	284	293	302	
R [Ohm]	47.24	41.42	36.51	32.38	28.81	25.70	23.00	20.66	18.59	

9.1.2.3 Pt100 RTD

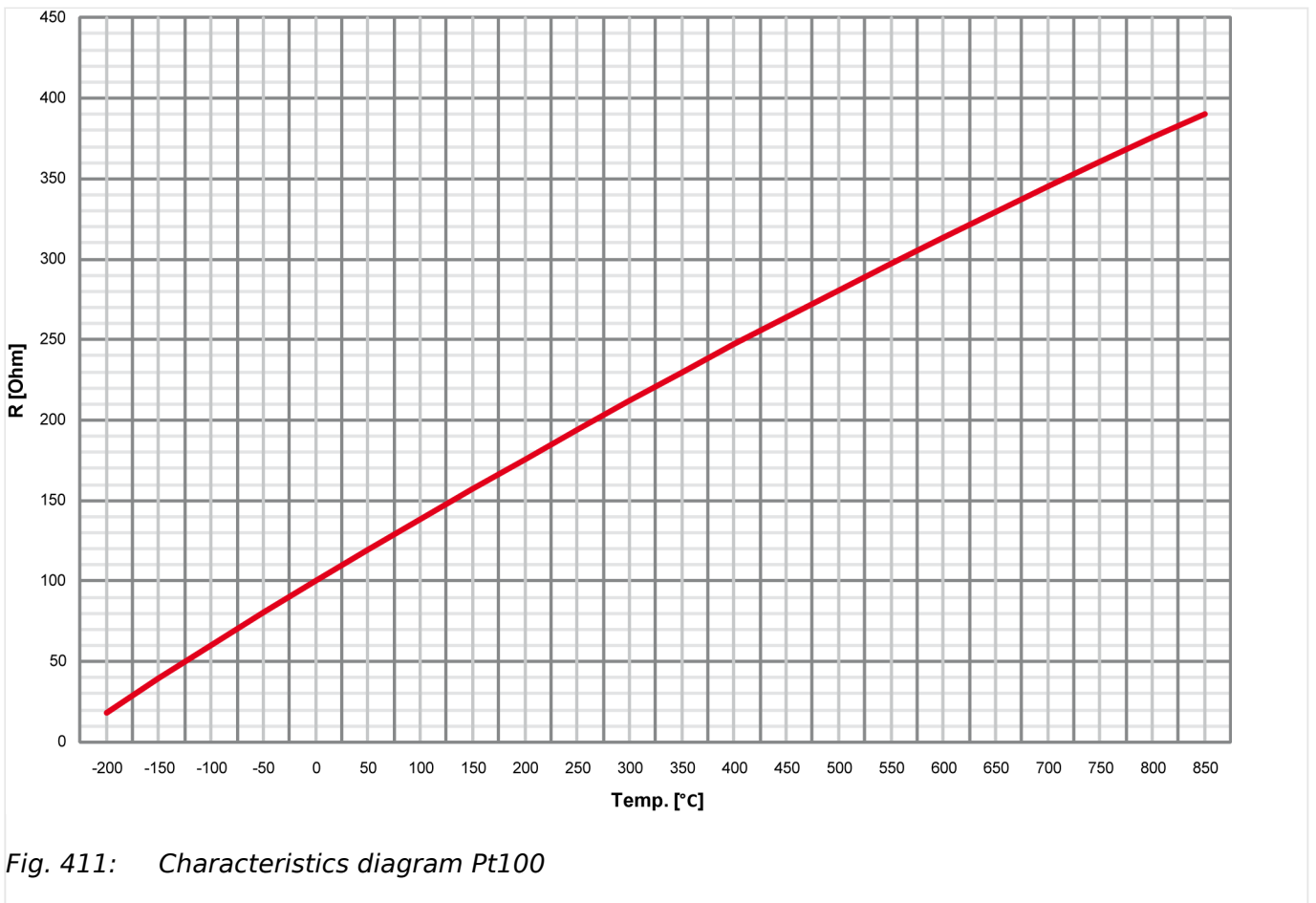

Fig. 411: Characteristics diagram Pt100

9 Appendix

9.1.2.4 Pt1000 RTD

Temp. [°C]	-200	-150	-100	-50	0	10	20	30	40	50	60
Temp. [°F]	-328	-238	-148	-58	32	50	68	86	104	122	140
R [Ohm]	18.5	39.7	60.25	80.7	100	103.9	107.8	111.7	115.5	119.4	123.2

Temp. [°C]	70	80	90	100	125	150	175	200	225	250	300
Temp. [°F]	158	176	194	212	257	302	347	392	437	482	572
R [Ohm]	127.1	130.9	134.7	138.5	147.9	157.3	166.6	175.8	188.6	194.1	212.0

Temp. [°C]	350	400	450	500	550	600	650	700	750	800	850
Temp. [°F]	662	752	842	932	1022	1112	1202	1292	1382	1472	1562
R [Ohm]	229.7	247.0	264.1	280.9	297.4	313.6	329.5	345.1	360.5	375.5	390.25

9.1.2.4 Pt1000 RTD

The characteristic of the Pt1000 temperature sender accords the characteristic diagram Pt100 at which the R value is to multiply with 10. Refer to [9.1.2.3 Pt100 RTD](#) for details.

9.1.2.5 NTC-Sender "AB_94099" (AB-Elektronik Sachsen GmbH)

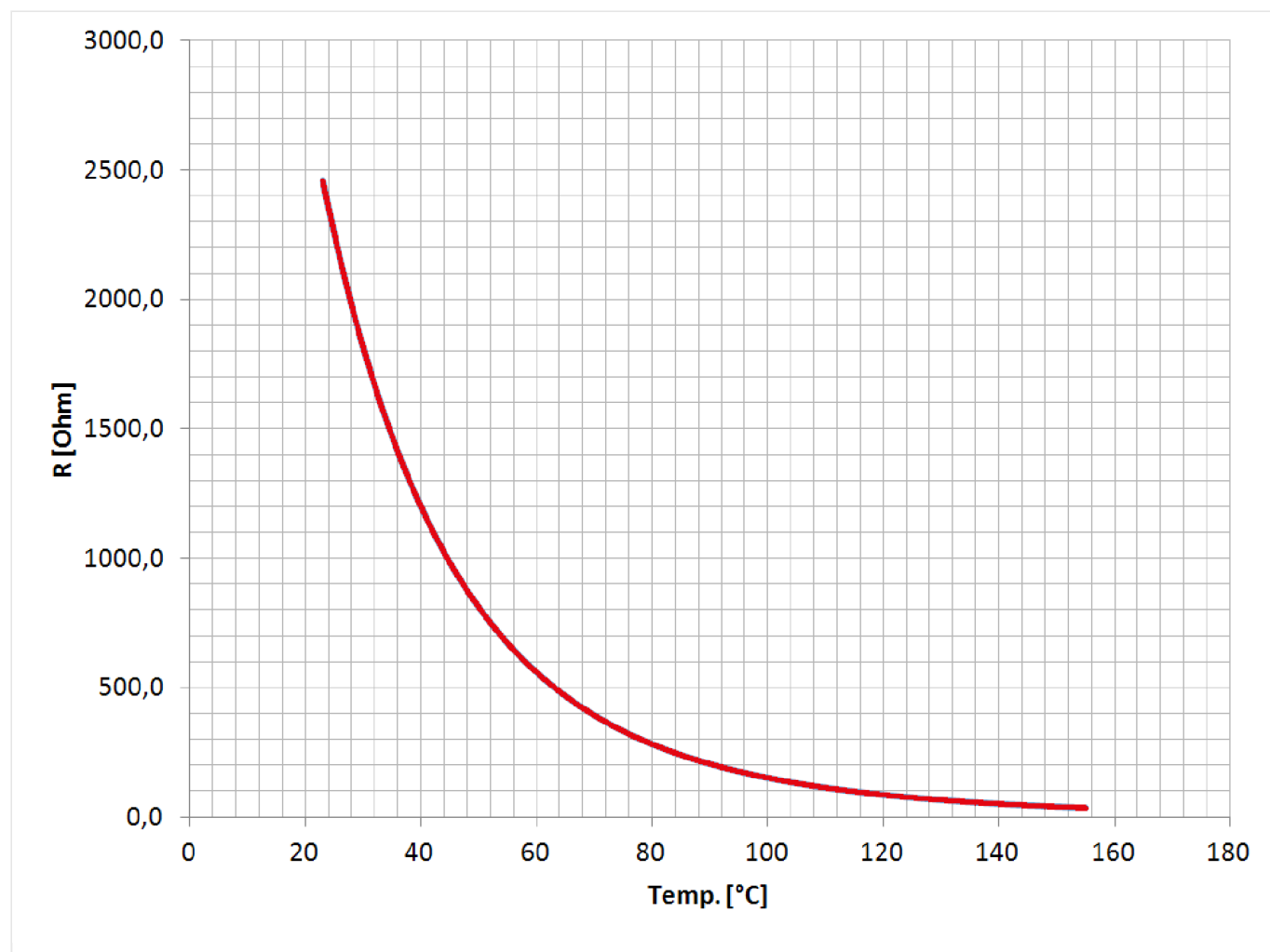

Fig. 412: Characteristic diagram "AB_94099"

9.2 Data Protocols

General note



The following data protocols / data telegrams are describing the currently defined full set of data for each protocol. Please ignore data your device does not support.

The following data protocols are implemented to be used

CANopen/Modbus

- 5003: Basic Visualization
supported for easYgen-3000 series compatibility
- 5014: Basic Visualization (based on 5003)

CANopen

- 5004: Generator Values Visualization
supported for easYgen-3000 series compatibility
- 5005: Mains Values Visualization
supported for easYgen-3000 series compatibility
- 5011: (preferred data protocol is 5017)
Alarm Values Visualization
supported for easYgen-3000 series compatibility
- 5017: Alarm Values Visualization
- 5018: Special data 1 (only CAN)
- 5019: Special data 2 (only CAN)
- 5020: Special data 3 (only CAN)
- 5021: Special data 4 (only CAN)
- 65000: External Discrete I/O 1 to 8
- 65001: External Discrete I/O 9 to 16
- 65002: External Discrete I/O 17 to 24
- 65003: External Discrete I/O 25 to 32

Modbus

- 5010: Basic Visualization
supported for easYgen-3000 series compatibility
- 5016: Basic Visualization (based on 5010)



Protocol tables

Please browse the documentation server for data protocol tables as separate MS Excel files (for url see [↪ “QR Code”](#)).

9.2.1 Protocol 5003 (Basic Visualization)

Modbus-Address	CAN Mux	CAN Byte	Size	Index	Description	Unit	Scale	Model
50000	0	1-2	int16		Protocol-ID, always 5003			All
50001	0	3-4	int16	10100	Pickup speed	rpm	*1	All
50002	0	5-6			BITLIST			
					Control mode (STOP/AUTO/MANUAL/TEST)		Mask:000Fh	All

Modbus-Address	CAN Mux	CAN Byte	Size	Index	Description	Unit	Scale	Model
					1=AUTO - 04.01 Operation Mode Auto 2=STOP - 04.02 Operation Mode Stop 4=MANUAL - 04.03 Operation Mode Man 8=TEST - 04.03 Operation Mode Test			
50003	1	1-2	int16	160	Gen. powerfactor		*1000	All
50004	1	3-6	int32	170	Av. Gen. Wye-Voltage	V	*10	All
50006	2	1-2	int16	144	Gen. frequency	Hz	*100	All
50007	2	3-6	int32	171	Av. Gen. Delta-Voltage	V	*10	All
50009	3	1-2	int16	147	Mains frequency	Hz	*100	All
50010	3	3-6	int32	173	Av. Mains Wye-Voltage	V	*10	All
50012	4	1-2	int16	208	Mains power factor		*1000	All
50013	4	3-6	int32	174	Av. Mains Delta-Voltage	V	*10	All
50015	5	1-2	int16	209	Busbar 1: Frequency	Hz	*100	All
50016	5	3-6	int32	216	Av. Busbar 1 Delta-Voltage	V	*10	All
50018	6	1-2	int16		Internal			
50019	6	3-4	int16		Internal			
50020	6	5-6	int16		Internal			
50021	7	1-2	int16	10110	Battery voltage	V	*10	All
50022	7	3-6	int32	207	Av. Mains Current	A	*1000	All
50024	8	1-2	int16	10111	Analog input 1		configurable	All
50025	8	3-6	int32	185	Av. Gen. Current	A	*1000	All
50027	9	1-2	int16	10112	Analog input 2		configurable	All
50028	9	3-6	int32	161	Meas. ground current	A	*1000	All
50030	10	1-2	int16	10115	Analog input 3		configurable	All
50031	10	3-6	int32	159	Calculated ground current	A	*1000	All
50033	11	1-2	int16	10117	Analog input 4		configurable	EG3500XT-P2
50034	11	3-6	int32	111	Gen. current 1	A	*1000	All
50036	12	1-2	int16	10151	Analog input 5		configurable	EG3500XT-P2
50037	12	3-6	int32	112	Gen. current 2	A	*1000	All
50039	13	1-2	int16	10152	Analog input 6		configurable	EG3500XT-P2
50040	13	3-6	int32	113	Gen. current 3	A	*1000	All
50042	14	1-2	int16	10153	Analog input 7		configurable	EG3500XT-P2
50043	14	3-6	int32	134	Mains current L1	A	*1000	All
50045	15	1-2	int16	10154	Analog input 8		configurable	EG3500XT-P2
50046	15	3-4	int16		Internal			

9 Appendix

9.2.1 Protocol 5003 (Basic Visualization)

Modbus-Address	CAN Mux	CAN Byte	Size	Index	Description	Unit	Scale	Model
50047	15	5-6	int16		Internal			
50048	16	1-2	int16	10155	Analog input 9		configurable	EG3500XT-P2
50049	16	3-4	int16		Internal			
50050	16	5-6	int16		Internal			
50051	17	1-2	int16	10156	Analog input 10		configurable	EG3500XT-P2
50052	17	3-6	int32	135	Total gen. power	W	*1	All
50054	18	1-2	int16		Internal			
50055	18	3-6	int32	140	Total mains power	W	*1	All
50057	19	1-2	int16		Internal			
50058	19	3-6	int32	136	Total gen. reactive power	var	*1	All
50060	20	1-2	int16	10159	AI Auxiliary excitation D+	V	*10	All
50061	20	3-6	int32	150	Total mains reactive power	var	*1	All
50063	21	1-2	uint16	10133	BITLIST			
					08.18 LM CANopen error at CAN Interface 1		Mask: 0001h	All
					05.10 LM Maintenance hours exceeded latched		Mask: 0002h	All
					05.09 LM Maintenance days exceeded latched		Mask: 0004h	All
					05.08 LM Start fail detected latched		Mask: 0008h	All
					08.10 LM General CAN-J1939 fault latched		Mask: 0010h	All
					08.08 LM MCB fail to open latched		Mask: 0020h	All
					08.07 LM MCB fail to close latched		Mask: 0040h	All
					08.06 LM GCB fail to open latched		Mask: 0080h	All
					08.05 LM GCB fail to close latched		Mask: 0100h	All
					05.06 LM Shutdown malfunction detected latched		Mask: 0200h	All
					05.07 LM Speed detection alarm latched		Mask: 0400h	All
					05.05 LM Unintended stop detected latched		Mask: 0800h	All
					05.04 LM Engine under speed 2 latched		Mask: 1000h	All
					05.03 LM Engine under speed 1 latched		Mask: 2000h	All
					05.02 LM Engine Over speed 2 latched		Mask: 4000h	All
					05.01 LM Engine Over speed 1 latched		Mask: 8000h	All
50064	21	3-6		182	Busbar 1: voltage L1-L2	V	*10	All
50066	22	1-2		10149	BITLIST			
					08.30 GCB syn. timeout latched		Mask: 8000h	All
					08.31 MCB syn. timeout latched		Mask: 4000h	All

Modbus-Address	CAN Mux	CAN Byte	Size	Index	Description	Unit	Scale	Model
					08.32 GGB Timeout latched		Mask: 2000h	EG3500XT-P1 EG3500XT-P2
					05.11 Charge alt. low voltage (D+) latched		Mask: 1000h	All
					operating range failure 12		Mask: 0800h	All
					08.45 CPU overload R1 trip		Mask: 0400h	All
					08.47 MCB failure 50BF latched		Mask: 0200h	All
					08.46 GCB failure 50BF latched		Mask: 0100h	All
					05.22 ECU Protect alarm latched		Mask: 0080h	All
					05.23 ECU Emission alarm latched		Mask: 0040h	All
					08.19 CANopen error at CAN Interface 2		Mask: 0020h	All
					08.16 Parameter Alignment latched		Mask: 0010h	All
					08.27 Missing easYgen latched		Mask: 0008h	All
					08.48 MCB plausibility latched		Mask: 0004h	All
					05.13 Red stop lamp latched		Mask: 0002h	All
					05.14 Amber warning lamp latched		Mask: 0001h	All
50067	22	3-4	int16		Internal			
50068	22	5-6	int16		Internal			
50069	23	1-2	uint16	10286	BITLIST			
					08.53 LS interf.redundancy latched		Mask: 8000h	EG3500XT-P1 EG3500XT-P2
					Internal		Mask: 4000h	All
					16.04 Free alarm 4 latched		Mask: 2000h	All
					16.03 Free alarm 3 latched		Mask: 1000h	All
					16.02 Free alarm 2 latched		Mask: 0800h	All
					16.01 Free alarm 1 latched		Mask: 0400h	All
					05.21 Max. starts per time		Mask: 0200h	K36
					17.09 Neutral contactor reply mismatch latched		Mask: 0100h	All
					17.08 Decoupling GCB<->MCB latched		Mask: 0080h	All
					17.07 Meas.difference 4105 VDE-AR-N 4105 latched		Mask: 0040h	All
					17.06 Parameter alignment VDE-AR-N 4105 latched		Mask: 0020h	All
					17.05 Missing member VDE-AR-N 4105 latched		Mask: 0010h	All
					08.22 Busbar monitoring latched		Mask: 0008h	All

9 Appendix

9.2.1 Protocol 5003 (Basic Visualization)

Modbus-Address	CAN Mux	CAN Byte	Size	Index	Description	Unit	Scale	Model
					08.21 Feedback GCB mismatch latched		Mask: 0004h	MARINE
					17.02 Reactive load share mismatch latched		Mask: 0002h	All
					17.01 Active load share mismatch latched		Mask: 0001h	All
50070	23	3-4	int16		Internal			
50071	23	5-6	int16		Internal			
50072	24	1-2	uint16	10134	BITLIST Alarms Generator latched (unacknowledged)			
					06.01 Generator over frequency 1 latched		Mask: 8000h	All
					06.02 Generator over frequency 2 latched		Mask: 4000h	All
					06.03 Generator under frequency 1 latched		Mask: 2000h	All
					06.04 Generator under frequency 2 latched		Mask: 1000h	All
					06.05 Generator over voltage 1 latched		Mask: 0800h	All
					06.06 Generator over voltage 2 latched		Mask: 0400h	All
					06.07 Generator under voltage 1 latched		Mask: 0200h	All
					06.08 Generator under voltage 2 latched		Mask: 0100h	All
					06.09 Generator over current 1 latched		Mask: 0080h	All
					06.10 Generator over current 2 latched		Mask: 0040h	All
					06.11 Generator over current 3 latched		Mask: 0020h	All
					06.12 Reverse / reduced power 1 latched		Mask: 0010h	All
					06.13 Reverse / reduced power 2 latched		Mask: 0008h	All
					06.14 Generator overload IOP 1 latched		Mask: 0004h	All
					06.15 Generator overload IOP 2 latched		Mask: 0002h	All
					06.34 Busbar phase rotation mismatch		Mask: 0001h	EG3500XT-P2
50073	24	3-6	int32	108	Gen. voltage L1-L2	V	*10	All
50075	25	1-2	uint16	10138	BITLIST Alarms Generator 1 latched (unacknowledged)			
					06.16 Generator unbalanced load 1 latched		Mask: 8000h	All
					06.17 Generator unbalanced load 2 latched		Mask: 4000h	All
					06.18 Generator voltage asymmetry latched		Mask: 2000h	All
					06.19 Ground fault 1 latched		Mask: 1000h	All
					06.20 Ground fault 2 latched		Mask: 0800h	All

Modbus-Address	CAN Mux	CAN Byte	Size	Index	Description	Unit	Scale	Model
					06.21 Gen. Phase Rotation mismatch Latched		Mask: 0400h	All
					06.29 Gen. active power mismatch Latched		Mask: 0200h	All
					06.30 Generator unloading mismatch Latched		Mask: 0100h	All
					06.22 Inverse time over current Latched		Mask: 0080h	All
					06.31 Operating Range failed latched		Mask: 0040h	All
					06.23 Generator overload MOP 1 latched		Mask: 0020h	All
					06.24 Generator overload MOP 2 latched		Mask: 0010h	All
					06.25 Gen.Power Factor lagging 1 latched		Mask: 0008h	All
					06.26 Gen.Power Factor lagging 2 latched		Mask: 0004h	All
					06.27 Gen.Power Factor leading 1 latched		Mask: 0002h	All
					06.28 Gen.Power Factor leading 2 latched		Mask: 0001h	All
50076	25	3-6	int32	114	Gen. voltage L1-N	V	*10	All
50078	26	1-2	uint16	10135	BITLIST			
					07.06 Mains over frequency 1 latched		Mask: 8000h	All
					07.07 Mains over frequency 2 latched		Mask: 4000h	All
					07.08 Mains under frequency 1 latched		Mask: 2000h	All
					07.09 Mains under frequency 2 latched		Mask: 1000h	All
					07.10 Mains over voltage 1 latched		Mask: 0800h	All
					07.11 Mains over voltage 2 latched		Mask: 0400h	All
					07.12 Mains under voltage 1 latched		Mask: 0200h	All
					07.13 Mains under voltage 2 latched		Mask: 0100h	All
					07.14 Mains Phase shift latched		Mask: 0080h	All
					07.25 Mains decoupling latched		Mask: 0040h	All
					Internal		Mask: 0020h	
					Internal		Mask: 0010h	
					Internal		Mask: 0008h	
					07.05 Mains Phase rotation mismatch latched		Mask: 0004h	All
					Internal		Mask: 0002h	
					Internal		Mask: 0001h	
50079	26	3-6	int32	109	Gen. voltage L2-L3	V	*10	All
50081	27	1-2	uint32	10278	BITLIST			
					07.21 Mains import power 1 latched		Mask: 8000h	All

9 Appendix

9.2.1 Protocol 5003 (Basic Visualization)

Modbus-Address	CAN Mux	CAN Byte	Size	Index	Description	Unit	Scale	Model
					07.22 Mains import power 2 latched		Mask: 4000h	All
					07.23 Mains export power 1 latched		Mask: 2000h	All
					07.24 Mains export power 2 latched		Mask: 1000h	All
					07.17 Mains PF lagging 1 latched		Mask: 0800h	All
					07.18 Mains PF lagging 2 latched		Mask: 0400h	All
					07.19 Mains PF leading 1 latched		Mask: 0200h	All
					07.20 Mains PF leading 2 latched		Mask: 0100h	All
					07.15 Mains df/dt latched		Mask: 0080h	All
					07.16 Mains active power mismatch latched		Mask: 0040h	All
					07.28 Mains Time-dep. Voltage (FRT) latched		Mask: 0020h	All
					Internal		Mask: 0010h	
					07.27 Mains slow voltage increase (10 min)		Mask: 0008h	All
					Internal		Mask: 0004h	
					07.29 QU Monitoring step 1 tripped		Mask: 0002h	All
					07.30 QU Monitoring step 2 tripped		Mask: 0001h	All
50082	27	3-6	int32	115	Gen. voltage L2-N	V	*10	All
50084	28	1-2	uint16	10132	BITLIST			
					09.01 Discrete input 1 latched		Mask: 8000h	All
					09.02 Discrete input 2 latched		Mask: 4000h	All
					09.03 Discrete input 3 latched		Mask: 2000h	All
					09.04 Discrete input 4 latched		Mask: 1000h	All
					09.05 Discrete input 5 latched		Mask: 0800h	All
					09.06 Discrete input 6 latched		Mask: 0400h	All
					09.07 Discrete input 7 latched		Mask: 0200h	All
					09.08 Discrete input 8 latched		Mask: 0100h	All
					09.09 Discrete input 9 latched		Mask: 0080h	All
					09.10 Discrete input 10 latched		Mask: 0040h	All
					09.11 Discrete input 11 latched		Mask: 0020h	All
					09.12 Discrete input 12 latched		Mask: 0010h	All
					Internal		Mask: 0008h	
					Internal		Mask: 0004h	
					Internal		Mask: 0002h	
					Internal		Mask: 0001h	
50085	28	3-6	int32	110	Gen. voltage L3-L1	V	*10	All
50087	29	1-2	uint32	10283	BITLIST			

Modbus-Address	CAN Mux	CAN Byte	Size	Index	Description	Unit	Scale	Model
					09.13 Discrete input 13 latched		Mask: 8000h	EG3500XT-P2
					09.14 Discrete input 14 latched		Mask: 4000h	EG3500XT-P2
					09.15 Discrete input 15 latched		Mask: 2000h	EG3500XT-P2
					09.16 Discrete input 16 latched		Mask: 1000h	EG3500XT-P2
					09.17 Discrete input 17 latched		Mask: 0800h	EG3500XT-P2
					09.18 Discrete input 18 latched		Mask: 0400h	EG3500XT-P2
					09.19 Discrete input 19 latched		Mask: 0200h	EG3500XT-P2
					09.20 Discrete input 20 latched		Mask: 0100h	EG3500XT-P2
					09.21 Discrete input 21 latched		Mask: 0080h	EG3500XT-P2
					09.22 Discrete input 22 latched		Mask: 0040h	EG3500XT-P2
					09.23 Discrete input 23 latched		Mask: 0020h	EG3500XT-P2
					Internal		Mask: 0010h	
					Internal		Mask: 0008h	
					Internal		Mask: 0004h	
					Internal		Mask: 0002h	
					Internal		Mask: 0001h	
50088	29	3-6	int32	116	Gen. voltage L3-N	V	*10	All
50090	30	1-2	uint16	16377	BITLIST			
					12.16 External discrete input 16 latched		Mask: 8000h	All
					12.15 External discrete input 15 latched		Mask: 4000h	All
					12.14 External discrete input 14 latched		Mask: 2000h	All
					12.13 External discrete input 13 latched		Mask: 1000h	All
					12.12 External discrete input 12 latched		Mask: 0800h	All
					12.11 External discrete input 11 latched		Mask: 0400h	All
					12.10 External discrete input 10 latched		Mask: 0200h	All
					12.09 External discrete input 9 latched		Mask: 0100h	All
					12.08 External discrete input 8 latched		Mask: 0080h	All
					12.07 External discrete input 7 latched		Mask: 0040h	All
					12.06 External discrete input 6 latched		Mask: 0020h	All
					12.05 External discrete input 5 latched		Mask: 0010h	All
					12.04 External discrete input 4 latched		Mask: 0008h	All
					12.03 External discrete input 3 latched		Mask: 0004h	All

9 Appendix

9.2.1 Protocol 5003 (Basic Visualization)

Modbus-Address	CAN Mux	CAN Byte	Size	Index	Description	Unit	Scale	Model
					12.02 External discrete input 2 latched		Mask: 0002h	All
					12.01 External discrete input 1 latched		Mask: 0001h	All
50091	30	3-6	int32	118	Mains voltage L1-L2	V	*10	All
50093	31	1-2	uint16	10279	BITLIST			
					15.16 Flexible limit 16 latched		Mask: 8000h	All
					15.15 Flexible limit 15 latched		Mask: 4000h	All
					15.14 Flexible limit 14 latched		Mask: 2000h	All
					15.13 Flexible limit 13 latched		Mask: 1000h	All
					15.12 Flexible limit 12 latched		Mask: 0800h	All
					15.11 Flexible limit 11 latched		Mask: 0400h	All
					15.10 Flexible limit 10 latched		Mask: 0200h	All
					15.09 Flexible limit 9 latched		Mask: 0100h	All
					15.08 Flexible limit 8 latched		Mask: 0080h	All
					15.07 Flexible limit 7 latched		Mask: 0040h	All
					15.06 Flexible limit 6 latched		Mask: 0020h	All
					15.05 Flexible limit 5 latched		Mask: 0010h	All
					15.04 Flexible limit 4 latched		Mask: 0008h	All
					15.03 Flexible limit 3 latched		Mask: 0004h	All
					15.02 Flexible limit 2 latched		Mask: 0002h	All
					15.01 Flexible limit 1 latched		Mask: 0001h	All
50094	31	3-6	int32	121	Mains voltage L1-N	V	*10	All
50096	32	1-2	uint16	10280	BITLIST			
					15.32 Flexible limit 32 latched		Mask: 8000h	All
					15.31 Flexible limit 31 latched		Mask: 4000h	All
					15.30 Flexible limit 30 latched		Mask: 2000h	All
					15.29 Flexible limit 29 latched		Mask: 1000h	All
					15.28 Flexible limit 28 latched		Mask: 0800h	All
					15.27 Flexible limit 27 latched		Mask: 0400h	All
					15.26 Flexible limit 26 latched		Mask: 0200h	All
					15.25 Flexible limit 25 latched		Mask: 0100h	All
					15.24 Flexible limit 24 latched		Mask: 0080h	All
					15.23 Flexible limit 23 latched		Mask: 0040h	All
					15.22 Flexible limit 22 latched		Mask: 0020h	All
					15.21 Flexible limit 21 latched		Mask: 0010h	All
					15.20 Flexible limit 20 latched		Mask: 0008h	All
					15.19 Flexible limit 19 latched		Mask: 0004h	All
					15.18 Flexible limit 18 latched		Mask: 0002h	All

Modbus-Address	CAN Mux	CAN Byte	Size	Index	Description	Unit	Scale	Model
					15.17 Flexible limit 17 latched		Mask: 0001h	All
50097	32	3-6	int32	119	Mains voltage L2-L3	V	*10	All
50099	33	1-2	uint16	10281	BITLIST			
					Internal		Mask: 8000h	
					Internal		Mask: 4000h	
					Internal		Mask: 2000h	
					Internal		Mask: 1000h	
					Internal		Mask: 0800h	
					Internal		Mask: 0400h	
					Internal		Mask: 0200h	
					Internal		Mask: 0100h	
					15.40 Flexible limit 40 latched		Mask: 0080h	All
					15.39 Flexible limit 39 latched		Mask: 0040h	All
					15.38 Flexible limit 38 latched		Mask: 0020h	All
					15.37 Flexible limit 37 latched		Mask: 0010h	All
					15.36 Flexible limit 36 latched		Mask: 0008h	All
					15.35 Flexible limit 35 latched		Mask: 0004h	All
					15.34 Flexible limit 34 latched		Mask: 0002h	All
					15.33 Flexible limit 33 latched		Mask: 0001h	All
50100	33	3-6	int32	122	Mains voltage L2-N	V	*10	All
50102	34	1-2	uint16	10136	BITLIST			
					Internal		Mask: 8000h	
					Internal		Mask: 4000h	
					Internal		Mask: 2000h	
					Internal		Mask: 1000h	
					Internal		Mask: 0800h	
					Internal		Mask: 0400h	
					Internal		Mask: 0200h	
					Internal		Mask: 0100h	
					Internal		Mask: 0080h	
					Internal		Mask: 0040h	
					Internal		Mask: 0020h	
					Internal		Mask: 0010h	
					08.02 Battery over voltage 2 latched		Mask: 0008h	All
					08.04 Battery under voltage 2 latched		Mask: 0004h	All
					08.01 Battery over voltage 1 latched		Mask: 0002h	All
					08.03 Battery under voltage 1 latched		Mask: 0001h	All

9 Appendix

9.2.1 Protocol 5003 (Basic Visualization)

Modbus-Address	CAN Mux	CAN Byte	Size	Index	Description	Unit	Scale	Model
50103	34	3-6	int32	120	Mains voltage L3-L1	V	*10	All
50105	35	1-2	uint16	10131	BITLIST			
					01.11 New Alarm triggered		Mask: 8000h	All
					Internal		Mask: 4000h	
					Internal		Mask: 2000h	
					Internal		Mask: 1000h	
					Internal		Mask: 0800h	
					Internal		Mask: 0400h	
					Internal		Mask: 0200h	
					Internal		Mask: 0100h	
					Internal		Mask: 0080h	
					Internal		Mask: 0040h	
					01.06 Alarm class F latched		Mask: 0020h	All
					01.05 Alarm class E latched		Mask: 0010h	All
					01.04 Alarm class D latched		Mask: 0008h	All
					01.03 Alarm class C latched		Mask: 0004h	All
					01.02 Alarm class B latched		Mask: 0002h	All
					01.01 Alarm class A latched		Mask: 0001h	All
50106	35	3-6	int32	123	Mains voltage L3-N	V	*10	All
50108	36	1-2	uint16	10137	BITLIST			
					Internal		Mask: 0001h	
					10.01 Analog input 1 wire break		Mask: 0002h	All
					10.02 Analog input 2 wire break		Mask: 0004h	All
					10.03 Analog input 3 wire break		Mask: 0008h	All
					10.04 Analog input 4 wire break		Mask: 0010h	EG3500XT-P2
					10.05 Analog input 5 wire break		Mask: 0020h	EG3500XT-P2
					10.06 Analog input 6 wire break		Mask: 0040h	EG3500XT-P2
					10.07 Analog input 7 wire break		Mask: 0080h	EG3500XT-P2
					10.08 Analog input 8 wire break		Mask: 0100h	EG3500XT-P2
					10.09 Analog input 9 wire break		Mask: 0200h	EG3500XT-P2
					10.10 Analog input 10 wire break		Mask: 0400h	EG3500XT-P2
					Internal		Mask: 0800h	
					Internal		Mask: 1000h	
					Internal		Mask: 2000h	

Modbus-Address	CAN Mux	CAN Byte	Size	Index	Description	Unit	Scale	Model
					Internal		Mask: 4000h	
					Internal		Mask: 8000h	
50109	36	3-4	int16	15310	Turbocharger 1 Compressor Outlet Temperature	°C	*10	All
50110	36	5-6	uint16	10285	BITLIST			
					25.01 Ext. analog input 1 wire break		Mask: 0001h	All
					25.02 Ext. analog input 2 wire break		Mask: 0002h	All
					25.03 Ext. analog input 3 wire break		Mask: 0004h	All
					25.04 Ext. analog input 4 wire break		Mask: 0008h	All
					25.05 Ext. analog input 5 wire break		Mask: 0010h	All
					25.06 Ext. analog input 6 wire break		Mask: 0020h	All
					25.07 Ext. analog input 7 wire break		Mask: 0040h	All
					25.08 Ext. analog input 8 wire break		Mask: 0080h	All
					25.09 Ext. analog input 9 wire break		Mask: 0100h	All
					25.10 Ext. analog input 10 wire break		Mask: 0200h	All
					25.11 Ext. analog input 11 wire break		Mask: 0400h	All
					25.12 Ext. analog input 12 wire break		Mask: 0800h	All
					25.13 Ext. analog input 13 wire break		Mask: 1000h	All
					25.14 Ext. analog input 14 wire break		Mask: 2000h	All
					25.15 Ext. analog input 15 wire break		Mask: 4000h	All
					25.16 Ext. analog input 16 wire break		Mask: 8000h	All
50111	37	1-2	uint16	10107	BITLIST			
					13.01 Relay-Output 1 (Self-test-relay)		Mask: 8000h	All
					13.02 Relay-Output 2		Mask: 4000h	All
					13.03 Relay-Output 3		Mask: 2000h	All
					13.04 Relay-Output 4		Mask: 1000h	All
					13.05 Relay-Output 5		Mask: 0800h	All
					13.06 Relay-Output 6		Mask: 0400h	All
					13.07 Relay-Output 7		Mask: 0200h	All
					13.08 Relay-Output 8		Mask: 0100h	All
					13.09 Relay-Output 9		Mask: 0080h	All
					13.10 Relay-Output 10		Mask: 0040h	All
					13.11 Relay-Output 11		Mask: 0020h	All
					13.12 Relay-Output 12		Mask: 0010h	All
					Internal		Mask: 0008h	
					Internal		Mask: 0004h	
					Internal		Mask: 0002h	
					Internal		Mask: 0001h	

9 Appendix

9.2.1 Protocol 5003 (Basic Visualization)

Modbus-Address	CAN Mux	CAN Byte	Size	Index	Description	Unit	Scale	Model
50112	37	3-4	uint16	10109	BITLIST			
					13.13 Relay-Output 13		Mask: 8000h	EG3500XT-P2
					13.14 Relay-Output 14		Mask: 4000h	EG3500XT-P2
					13.15 Relay-Output 15		Mask: 2000h	EG3500XT-P2
					13.16 Relay-Output 16		Mask: 1000h	EG3500XT-P2
					13.17 Relay-Output 17		Mask: 0800h	EG3500XT-P2
					13.18 Relay-Output 18		Mask: 0400h	EG3500XT-P2
					13.19 Relay-Output 19		Mask: 0200h	EG3500XT-P2
					13.20 Relay-Output 20		Mask: 0100h	EG3500XT-P2
					13.21 Relay-Output 21		Mask: 0080h	EG3500XT-P2
					13.22 Relay-Output 22		Mask: 0040h	EG3500XT-P2
					Internal		Mask: 0020h	
					Internal		Mask: 0010h	
					Internal		Mask: 0008h	
					Internal		Mask: 0004h	
					13.34 Transistor output 2		Mask: 0002h	EG3500XT-P2
					13.33 Transistor output 1		Mask: 0001h	EG3500XT-P2
50113	37	5-6	uint16	8005	BITLIST			
					98.16 LM External DO 16		Mask: 8000h	All
					98.15 LM External DO 15		Mask: 4000h	All
					98.14 LM External DO 14		Mask: 2000h	All
					98.13 LM External DO 13		Mask: 1000h	All
					98.12 LM External DO 12		Mask: 0800h	All
					98.11 LM External DO 11		Mask: 0400h	All
					98.10 LM External DO 10		Mask: 0200h	All
					98.09 LM External DO 9		Mask: 0100h	All
					98.08 LM External DO 8		Mask: 0080h	All
					98.07 LM External DO 7		Mask: 0040h	All
					98.06 LM External DO 6		Mask: 0020h	All
					98.05 LM External DO 5		Mask: 0010h	All
					98.04 LM External DO 4		Mask: 0008h	All

Modbus-Address	CAN Mux	CAN Byte	Size	Index	Description	Unit	Scale	Model
					98.03 LM External DO 3		Mask: 0004h	All
					98.02 LM External DO 2		Mask: 0002h	All
					98.01 LM External DO 1		Mask: 0001h	All
50114	38	1-2	int16	10310	Analog output 1		configurable	All
50115	38	3-4	int16	10311	Analog output 2		configurable	All
50116	38	5-6	int16	10317	Analog output 3		configurable	EG3500XT-P2
50117	39	1-2	int16	10318	Analog output 4		configurable	EG3500XT-P2
50118	39	3-4	int16	10319	Analog output 5		configurable	EG3500XT-P2
50119	39	5-6	int16	10320	Analog output 6		configurable	EG3500XT-P2
50120	40	1-2	uint16	10202	Status message. This is an index number. Refer to manual chapter Status messages for more information.			All
50121	40	3-6	int32	2520	Gen. real energy	MWh	*100	All
50123	41	1-2	int16	2540	Engine, number of startrequests		*1	All
50124	41	3-6	int32	2522	Gen. positive reactive energy	Mvarh	*100	All
50126	42	1-2	int16	2558	Hours until next maintenance	h	*100	All
50127	42	3-6	int32	2568	Gen. hours of operation	h	*1	All
50129	43	1-2	int16	5541	Setpoint frequency	Hz	*100	All
50130	43	3-6	int32	5542	Setpoint active power	kW	*10	All
50132	44	1-4	int32	5640	Setpoint voltage	V	*1	All
50134	44	5-6	int16	5641	Setpoint power factor		*1000	All
50135	45	1-2	uint16	4153	BITLIST			
					Idle mode monitoring OR ramp to rated state is active		Mask: 8000h	All
					04.15 Idle run is active		Mask: 4000h	All
					04.12 Start without closing GCB		Mask: 2000h	All
					Internal		Mask: 1000h	
					A manual START has been requested		Mask: 0800h	All
					A manual STOP has been requested		Mask: 0400h	All
					04.10 Cooldown is active		Mask: 0200h	All
					03.01 Auxiliary Services is active		Mask: 0100h	All
					03.07 Engine monitoring delay expired		Mask: 0080h	All
					03.08 Breaker delay timer has expired		Mask: 0040h	All
					03.25 Engine shall run		Mask: 0020h	All
					04.27 Critical mode is active		Mask: 0010h	All
					03.06 Engine release is active		Mask: 0008h	All
					03.30 Auxiliary services prerun is active		Mask: 0004h	All

9 Appendix

9.2.1 Protocol 5003 (Basic Visualization)

Modbus-Address	CAN Mux	CAN Byte	Size	Index	Description	Unit	Scale	Model
					03.31 Auxiliary services postrun is active		Mask: 0002h	All
					04.61 Lamp test request		Mask: 0001h	All
50136	45	3-4	uint16	4154	BITLIST			
					03.02 Starter / Crank is active		Mask: 8000h	All
					03.28 Operating Magnet / Gasrelay is active		Mask: 4000h	All
					03.04 Preglow or Ignition is active		Mask: 2000h	All
					04.11 Mains settling		Mask: 1000h	All
					04.09 Emergency mode is currently active		Mask: 0800h	All
					03.40 Remote Shutdown (ID503, Bit9)		Mask: 0400h	All
					03.37 Free PID Controller 3: Lower Command		Mask: 0200h	All
					03.36 Free PID Controller 3: Raise Command		Mask: 0100h	All
					03.35 Free PID Controller 2: Lower Command		Mask: 0080h	All
					03.34 Free PID Controller 2: Raise Command		Mask: 0040h	All
					03.27 Stop solenoid is active		Mask: 0020h	All
					03.24 Excitation enabled (Run-up Synchronization)		Mask: 0010h	All
					The genset runs mains parallel		Mask: 0008h	All
					03.33 Free PID Controller 1: Lower Command		Mask: 0004h	All
					03.32 Free PID Controller 1: Raise Command		Mask: 0002h	All
					Increment Engine Start Counter (pulse 1 second)		Mask: 0001h	All
50137	45	5-6	uint16	4155	BITLIST			
					03.20 3-Pos. Controller Freq./Power raise		Mask: 8000h	All
					03.21 3-Pos. Controller Freq./Power lower		Mask: 4000h	All
					03.22 3-Pos. Controller Volt./ReactPow raise		Mask: 2000h	All
					03.23 3-Pos. Controller Volt./ReactPow lower		Mask: 1000h	All
					04.06 GCB is closed		Mask: 0800h	All
					04.07 MCB is closed		Mask: 0400h	All
					05.16 Derating active (J1939 or freely)		Mask: 0200h	All
					04.18 Synchronisation GCB procedure is active		Mask: 0100h	All
					04.19 Opening GCB relay is active		Mask: 0080h	All

Modbus-Address	CAN Mux	CAN Byte	Size	Index	Description	Unit	Scale	Model
					04.20 Close command GCB is active		Mask: 0040h	All
					04.21 Synchronisation MCB procedure is active		Mask: 0020h	All
					04.22 Open command MCB is active		Mask: 0010h	All
					04.23 Close command MCB is active		Mask: 0008h	All
					04.28 Unloading generator is active		Mask: 0004h	All
					04.29 Unloading mains is active		Mask: 0002h	All
					04.30 Power limited prerun		Mask: 0001h	All
50138	46	1-2	uint16	4156	BITLIST			
					04.16 GGB is closed		Mask: 8000h	EG3500XT-P1 EG3500XT-P2
					04.17 GGB is released		Mask: 4000h	EG3500XT-P1 EG3500XT-P2
					04.24 Synchronisation GGB procedure is active		Mask: 2000h	EG3500XT-P1 EG3500XT-P2
					04.25 Open command GGB is active		Mask: 1000h	EG3500XT-P1 EG3500XT-P2
					04.26 Close command GGB is active		Mask: 0800h	EG3500XT-P1 EG3500XT-P2
					Dead busbar closure requ. for GCB,MCB or GGB		Mask: 0400h	All
					4.62 Active power load share is active		Mask: 0200h	All
					4.63 Reactive power load share is active		Mask: 0100h	All
					Generator with a closed GCB is requested		Mask: 0080h	All
					LDSS: The Engine shall start		Mask: 0040h	All
					LDSS: The Engine shall stop		Mask: 0020h	All
					LDSS: The Engine shall stop, if possible		Mask: 0010h	All
					LDSS: Minimum Running Time is active		Mask: 0008h	All
					04.43 The LDSS function is active		Mask: 0004h	All
					04.60 Critical mode postrun		Mask: 0002h	All
					AUTOMATIC Run: Switch to Operating Mode STOP		Mask: 0001h	All

9 Appendix

9.2.1 Protocol 5003 (Basic Visualization)

Modbus-Address	CAN Mux	CAN Byte	Size	Index	Description	Unit	Scale	Model
50139	46	3-4	uint16	4150	BITLIST ControlBits5			
					04.13 Remote Start request		Mask: 8000h	All
					04.14 Remote acknowledge		Mask: 4000h	All
					05.17 Uprating active		Mask: 2000h	All
					86.25 LM Frequency Droop active		Mask: 1000h	All
					86.26 LM Voltage Droop active		Mask: 0800h	All
					Synchronization mode Check active		Mask: 0400h	All
					Synchronization mode Permissive active		Mask: 0200h	All
					Synchronization mode Run active		Mask: 0100h	All
					86.85 LM Enable MCB		Mask: 0080h	All
					86.41 LDSS IOP Reserve power 2 ready		Mask: 0040h	All
					86.42 LDSS MOP Reserve power 2 ready		Mask: 0020h	All
					02.39 Mains decoupling enabled		Mask: 0010h	All
					04.70 Opening GCB active		Mask: 0008h	All
					Parameter set 1-7 selection Bit 3	Bit	Mask: 0004h	Rental
					Parameter set 1-7 selection Bit 2	Bit	Mask: 0002h	Rental
					Parameter set 1-7 selection Bit 1	Bit	Mask: 0001h	Rental
50140	46	5-6	uint16	10284	BITLIST Alarm Ext. DI 2 latched (unacknowledged)			
					12.32 External discrete input 32 latched		Mask: 8000h	All
					12.31 External discrete input 31 latched		Mask: 4000h	All
					12.30 External discrete input 30 latched		Mask: 2000h	All
					12.29 External discrete input 29 latched		Mask: 1000h	All
					12.28 External discrete input 28 latched		Mask: 0800h	All
					12.27 External discrete input 27 latched		Mask: 0400h	All
					12.26 External discrete input 26 latched		Mask: 0200h	All
					12.25 External discrete input 25 latched		Mask: 0100h	All
					12.24 External discrete input 24 latched		Mask: 0080h	All
					12.23 External discrete input 23 latched		Mask: 0040h	All
					12.22 External discrete input 22 latched		Mask: 0020h	All
					12.21 External discrete input 21 latched		Mask: 0010h	All
					12.20 External discrete input 20 latched		Mask: 0008h	All
					12.19 External discrete input 19 latched		Mask: 0004h	All
					12.18 External discrete input 18 latched		Mask: 0002h	All
					12.17 External discrete input 17 latched		Mask: 0001h	All
50141	47	1-2	uint16	8009	BITLIST Relay Outputs 4			
					98.32 LM External DO 32		Mask: 8000h	All
					98.31 LM External DO 31		Mask: 4000h	All

Modbus-Address	CAN Mux	CAN Byte	Size	Index	Description	Unit	Scale	Model
					98.30 LM External DO 30		Mask: 2000h	All
					98.29 LM External DO 29		Mask: 1000h	All
					98.28 LM External DO 28		Mask: 0800h	All
					98.27 LM External DO 27		Mask: 0400h	All
					98.26 LM External DO 26		Mask: 0200h	All
					98.25 LM External DO 25		Mask: 0100h	All
					98.24 LM External DO 24		Mask: 0080h	All
					98.23 LM External DO 23		Mask: 0040h	All
					98.22 LM External DO 22		Mask: 0020h	All
					98.21 LM External DO 21		Mask: 0010h	All
					98.20 LM External DO 20		Mask: 0008h	All
					98.19 LM External DO 19		Mask: 0004h	All
					98.18 LM External DO 18		Mask: 0002h	All
					98.17 LM External DO 17		Mask: 0001h	All
50142	47	3-4	int16	10170	External Analog input 1		configurable	All
50143	47	5-6	int16	10171	External Analog input 2		configurable	All
50144	48	1-2	int16	10172	External Analog input 3		configurable	All
50145	48	3-4	int16	10173	External Analog input 4		configurable	All
50146	48	5-6	int16	10174	External Analog input 5		configurable	All
50147	49	1-2	int16	10175	External Analog input 6		configurable	All
50148	49	3-4	int16	10176	External Analog input 7		configurable	All
50149	49	5-6	int16	10177	External Analog input 8		configurable	All
50150	50	1-2	int16	10178	External Analog input 9		configurable	All
50151	50	3-4	int16	10179	External Analog input 10		configurable	All
50152	50	5-6	int16	10180	External Analog input 11		configurable	All
50153	51	1-2	int16	10181	External Analog input 12		configurable	All
50154	51	3-4	int16	10182	External Analog input 13		configurable	All
50155	51	5-6	int16	10183	External Analog input 14		configurable	All
50156	52	1-2	int16	10184	External Analog input 15		configurable	All
50157	52	3-4	int16	10185	External Analog input 16		configurable	All
50158	52	5-6	int16	10245	External Analog Output 1	%	*100	All
50159	53	1-2	int16	10255	External Analog Output 2	%	*100	All
50160	53	3-4	int16	10265	External Analog Output 3	%	*100	All
50161	53	5-6	int16	10275	External Analog Output 4	%	*100	All
50162	54	1-2	int16		Internal			
50163	54	3-6	int32	2580	Period of use counter	h	*100	All
50165	55	1-2	uint16	10190	BITLIST Alarms 3 latched (unacknowledged)			

9 Appendix

9.2.1 Protocol 5003 (Basic Visualization)

Modbus-Address	CAN Mux	CAN Byte	Size	Index	Description	Unit	Scale	Model
					08.34 GGB fail to close latched		Mask: 8000h	EG3500XT-P1 EG3500XT-P2
					08.35 GGB fail to open latched		Mask: 4000h	EG3500XT-P1 EG3500XT-P2
					08.27 Missing easYgen		Mask: 2000h	All
					08.28 Missing LSx		Mask: 1000h	EG3500XT-P1 EG3500XT-P2
					05.18 Cylinder temperature level 1		Mask: 0800h	All
					05.19 Cylinder temperature level 2		Mask: 0400h	All
					05.20 Cylinder temperature wire break		Mask: 0200h	All
					6.35 Pole slip		Mask: 0100h	All
					08.44 Syst.update LSx		Mask: 0080h	EG3500XT-P1 EG3500XT-P2
					08.43 Syst.update easYgen		Mask: 0040h	All
					06.32 Gen.AC Wiring		Mask: 0020h	All
					06.33 Busbar1 AC Wiring		Mask: 0010h	EG3500XT-P2
					Internal		Mask: 0008h	
					Internal		Mask: 0004h	
					Internal		Mask: 0002h	
					Internal		Mask: 0001h	
50166	55	3-6	int32	219	Nominal active power in system (in own segment)	kW	*1	All
50168	56	1-2	uint16	4157	BITLIST ControlBits6			
					28.01 Command 1 to LSx (OR)		Mask: 8000h	EG3500XT-P1 EG3500XT-P2
					28.02 Command 2 to LSx (OR)		Mask: 4000h	EG3500XT-P1 EG3500XT-P2
					28.03 Command 3 to LSx (OR)		Mask: 2000h	EG3500XT-P1

Modbus-Address	CAN Mux	CAN Byte	Size	Index	Description	Unit	Scale	Model
								EG3500XT-P2
					28.04 Command 4 to LSx (OR)		Mask: 1000h	EG3500XT-P1 EG3500XT-P2
					28.05 Command 5 to LSx (OR)		Mask: 0800h	EG3500XT-P1 EG3500XT-P2
					28.06 Command 6 to LSx (OR)		Mask: 0400h	EG3500XT-P1 EG3500XT-P2
					02.38 Gen excitation limit active		Mask: 0200h	All
					03.39 Neutral interlocking - Closed NC		Mask: 0100h	All
					05.17 Uprating active		Mask: 0080h	All
					Extended Busbar F okay		Mask: 0040h	Marine
					Extended Busbar V okay		Mask: 0020h	Marine
					Extended Busbar F/V okay		Mask: 0010h	Marine
					Extended Busbar is dead		Mask: 0008h	Marine
					Phaseangle MNS/BUS okay		Mask: 0004h	Marine
					Phaseangle GEN/BUS okay		Mask: 0002h	Marine
					03.38 Inhibit cranking		Mask: 0001h	All
50169	56	3-6	int32	218	Active real power in system (in own segment)	kW	*1	All
50171	57	1-2	int16		Internal			
50172	57	3-6	int32	217	Active power reserve in system (in own segment)	kW	*1	All
50174	58	1-2	int16	15109	J1939 MTU ADEC ECU Failure Codes		*1	All
50175	58	3-4	int16	239	System act.nom.pwr.	%	*100	All
50176	58	5-6	int16	240	Syst.total real pwr.	%	*100	All
50177	59	1-2	uint16	15304	J1939 EMR Engine Stop Information (refer to DEUTZ-specific J1939-Message) "Missing" Value="65535" "Error" Value="65279" "Type 9" Value="9" "Type 8" Value="8" "Type 7" Value="7" "Type 6" Value="6"			All

Modbus-Address	CAN Mux	CAN Byte	Size	Index	Description	Unit	Scale	Model
					"Type 5" Value="5" "Type 4" Value="4" "Type 3" Value="3" "Type 2" Value="2" "Type 1" Value="1" "Type 0" Value="0"			
50178	59	3-4	int16	241	Syst.res.real power	%	*100	All
50179	59	5-6	int16	15311	Engine Derate Request	%	*10	All
50180	60	1-2	uint16	15305	BITLIST J1939 DLN2-Message Scania S6			
					Engine Coolant Temperature		Mask F000h	
					J1939-Message not available		Mask 8000h	All
					Sensor fault		Mask 4000h	All
					High Temperature.		Mask 2000h	All
					NOT High Temperature		Mask 1000h	All
					Engine Oil Pressure		Mask 0F00h	
					J1939-Message not available		Mask 0800h	All
					Sensor fault		Mask 0400h	All
					Low Pressure		Mask 0200h	All
					NOT Low Pressure		Mask 0100h	All
					High Engine Oil Level		Mask 00F0h	
					J1939-Message not available		Mask 0080h	All
					Sensor fault		Mask 0040h	All
					High Level		Mask 0020h	All
					NOT High Level		Mask 0010h	All
					Low Engine Oil Level		Mask 000Fh	
					J1939-Message not available		Mask 0008h	All
					Sensor fault		Mask 0004h	All
					Low Level		Mask 0002h	All
					NOT Low Level		Mask 0001h	All
50181	60	3-4	int16	15313	Aftertreatment 1 Diesel Exhaust Fluid Tank Level	%	*10	All
50182	60	5-6	int16	15312	Battery Potential, Switched	V	*10	All
1. Active Diagnostic Trouble Code (DM1)								
50183	61	1-4	uint32	15400	SPN			All
50185	61	5-6	uint16		BITLIST			
				15401	FMI		Mask FF00h	All
				15402	OC		Mask 00FFh	All
2. Active Diagnostic Trouble Code (DM1)								

Modbus-Address	CAN Mux	CAN Byte	Size	Index	Description	Unit	Scale	Model
50186	62	1-4	uint32	15403	SPN			All
50188	62	5-6	uint16		BITLIST			
				15404	FMI		Mask FF00h	All
				15405	OC		Mask 00FFh	All
3. Active Diagnostic Trouble Code (DM1)								
50189	63	1-4	uint32	15406	SPN			All
50191	63	5-6	uint16		BITLIST			
				15407	FMI		Mask FF00h	All
				15408	OC		Mask 00FFh	All
4. Active Diagnostic Trouble Code (DM1)								
50192	64	1-4	uint32	15409	SPN			All
50194	64	5-6	uint16		BITLIST			
				15410	FMI		Mask FF00h	All
				15411	OC		Mask 00FFh	All
5. Active Diagnostic Trouble Code (DM1)								
50195	65	1-4	uint32	15412	SPN			All
50197	65	5-6	uint16		BITLIST			
				15413	FMI		Mask FF00h	All
				15414	OC		Mask 00FFh	All
6. Active Diagnostic Trouble Code (DM1)								
50198	66	1-4	uint32	15415	SPN			All
50200	66	5-6	uint16		BITLIST			
				15416	FMI		Mask FF00h	All
				15418	OC		Mask 00FFh	All
7. Active Diagnostic Trouble Code (DM1)								
50201	67	1-4	uint32	15419	SPN			All
50203	67	5-6	uint16	15420	BITLIST			
					FMI		Mask FF00h	All
				15421	OC		Mask 00FFh	All
8. Active Diagnostic Trouble Code (DM1)								
50204	68	1-4	uint32	15422	SPN			All
50206	68	5-6	uint16	15423	BITLIST			
					FMI		Mask FF00h	All
				15424	OC		Mask 00FFh	All
9. Active Diagnostic Trouble Code (DM1)								
50207	69	1-4	uint32	15425	SPN			All
50209	69	5-6	uint16		BITLIST			

Modbus-Address	CAN Mux	CAN Byte	Size	Index	Description	Unit	Scale	Model
				15426	FMI		Mask FF00h	All
				15427	OC		Mask 00FFh	All
10. Active Diagnostic Trouble Code (DM1)								
50210	70	1-4	uint32	15428	SPN			All
50212	70	5-6	uint16		BITLIST			
				15429	FMI		Mask FF00h	All
				15430	OC		Mask 00FFh	All
1. Previously Active Diagnostic Trouble Code (DM2)								
50213	71	1-4	uint32	15450	SPN		low 16 bits of 19 bits of SPN	All
50215	71	5-6	uint16		BITLIST			
				15451	FMI		Mask FF00h	All
				15452	OC		Mask 00FFh	All
2. Previously Active Diagnostic Trouble Code (DM2)								
50216	72	1-4	uint32	15453	SPN		low 16 bits of 19 bits of SPN	All
50218	72	5-6	uint16		BITLIST			
				15454	FMI		Mask FF00h	All
				15455	OC		Mask 00FFh	All
3. Previously Active Diagnostic Trouble Code (DM2)								
50219	73	1-4	uint32	15456	SPN		low 16 bits of 19 bits of SPN	All
50221	73	5-6	uint16		BITLIST			
				15457	FMI		Mask FF00h	All
				15458	OC		Mask 00FFh	All
4. Previously Active Diagnostic Trouble Code (DM2)								
50222	74	1-4	uint32	15459	SPN			All
50224	74	5-6	uint16		BITLIST			
				15460	FMI		Mask FF00h	All
				15461	OC		Mask 00FFh	All
5. Previously Active Diagnostic Trouble Code (DM2)								
50225	75	1-4	uint32	15462	SPN			All
50227	75	5-6	uint16		BITLIST			
				15463	FMI		Mask FF00h	All
				15464	OC		Mask 00FFh	All
6. Previously Active Diagnostic Trouble Code (DM2)								
50228	76	1-4	uint32	15465	SPN			All

Modbus-Address	CAN Mux	CAN Byte	Size	Index	Description	Unit	Scale	Model
50230	76	5-6	uint16		BITLIST			
				15466	FMI		Mask FF00h	All
				15467	OC		Mask 00FFh	All
7. Previously Active Diagnostic Trouble Code (DM2)								
50231	77	1-4	uint32	15468	SPN			All
50233	77	5-6	uint16		BITLIST			
				15469	FMI		Mask FF00h	All
				15470	OC		Mask 00FFh	All
8. Previously Active Diagnostic Trouble Code (DM2)								
50234	78	1-4	uint32	15471	SPN			All
50236	78	5-6	uint16		BITLIST			
				15472	FMI		Mask FF00h	All
				15473	OC		Mask 00FFh	All
9. Previously Active Diagnostic Trouble Code (DM2)								
50237	79	1-4	uint32	15474	SPN			All
50239	79	5-6	uint16		BITLIST			
				15475	FMI		Mask FF00h	All
				15476	OC		Mask 00FFh	All
10. Previously Active Diagnostic Trouble Code (DM2)								
50240	80	1-4	uint32	15477	SPN			All
50242	80	5-6	uint16		BITLIST			
				15478	FMI		Mask FF00h	All
				15479	OC		Mask 00FFh	All
50243	81	1-2	uint16	15395	BITLIST J1939 Lamp Status DM1			
					Malfunction Lamp			
					Internal		Mask 8000h	
					Internal		Mask 4000h	
					On		Mask 2000h	All
					Off		Mask 1000h	All
					Red Stop Lamp			
					Internal		Mask 0800h	
					Internal		Mask 0400h	
					On		Mask 0200h	All
					Off		Mask 0100h	All
					Amber Warning Lamp			
					Internal		Mask 0080h	
					Internal		Mask 0040h	

9 Appendix

9.2.1 Protocol 5003 (Basic Visualization)

Modbus-Address	CAN Mux	CAN Byte	Size	Index	Description	Unit	Scale	Model
					On		Mask 0020h	All
					Off		Mask 0010h	All
					Protect Lamp			
					Internal		Mask 0008h	
					Internal		Mask 0004h	
					On		Mask 0002h	All
					Off		Mask 0001h	All
50244	81	3-4	uint16	15445	BITLIST J1939 Lamp Status DM2			
					Malfunction Lamp			
					Internal		Mask 8000h	
					Internal		Mask 4000h	
					On		Mask 2000h	All
					Off		Mask 1000h	All
					Red Stop Lamp			
					Internal		Mask 0800h	
					Internal		Mask 0400h	
					On		Mask 0200h	All
					Off		Mask 0100h	All
					Amber Warning Lamp			
					Internal		Mask 0080h	
					Internal		Mask 0040h	
					On		Mask 0020h	All
					Off		Mask 0010h	All
					Protect Lamp			
					Internal		Mask 0008h	
					Internal		Mask 0004h	
					On		Mask 0002h	All
					Off		Mask 0001h	All
50245	81	5-6	int16	15314	Aftertreatment 1 Diesel Exhaust Fluid Tank Temperature	°C	*1	All
50246	82	1-4	int32	15200	Engine Speed (j1939-EEC1) Value for Error indicator: FFFFFFFEh Value for Not available: FFFFFFFFh	rpm	*10	All
50248	82	5-6	int16	15202	Engine Coolant Temperature (J1939-ET1) Value for Error indicator: FFFEh Value for Not available: FFFFh	°C	*1	All
50249	83	1-4	int32	15201	Total engine hours (j1939-HOURS)	h	*1	All

Modbus-Address	CAN Mux	CAN Byte	Size	Index	Description	Unit	Scale	Model
					Value for Error indicator: FFFFFFFEh Value for Not available: FFFFFFFFh			
50251	83	5-6	int16	15203	Fuel temperature (j1939-ET1) Value for Error indicator: FFFEh Value for Not available: FFFFh	°C	*1	All
50252	84	1-4	int32	15204	Engine Oil Temperature (j1939-ET1) Value for Error indicator: FFFFFFFEh Value for Not available: FFFFFFFFh	°C	*100	All
50254	84	5-6	int16	15205	Engine Oil Pressure (j1939-EFL/P1) Value for Error indicator: FFFEh Value for Not available: FFFFh	kPa	*1	All
50255	85	1-4	int32	15211	Fuel Rate (j1939-LFE) Value for Error indicator: FFFFFFFEh Value for Not available: FFFFFFFFh	L/h	*100	All
50257	85	5-6	int16	15206	Coolant Level (j1939-EFL/P1) Value for Error indicator: FFFEh Value for Not available: FFFFh	%	*10	All
50258	86	1-2	int16	15207	Throttle position (j1939-EEC2) Value for Error indicator: FFFEh Value for Not available: FFFFh	%	*10	All
50259	86	3-4	int16	15208	Load at current Speed (j1939-EEC2) Value for Error indicator: FFFEh Value for Not available: FFFFh	%	*1	All
50260	86	5-6	int16	15210	Engine oil level (j1939-EFL/P1) Value for Error indicator: FFFEh Value for Not available: FFFFh	%	*10	All
50261	87	1-2	int16	15214	Boost pressure (j1939-IC1) Value for Error indicator: FFFEh Value for Not available: FFFFh	kPa	*1	All
50262	87	3-4	int16	15215	Intake Manifold Temp (j1939-IC1) Value for Error indicator: FFFEh Value for Not available: FFFFh	°C	*1	All
50263	87	5-6	int16	15212	Barometric Pressure (j1939-AMB) Value for Error indicator: FFFEh	kPa	*10	All

Modbus-Address	CAN Mux	CAN Byte	Size	Index	Description	Unit	Scale	Model
					Value for Not available: FFFFh			
50264	88	1-2	int16	15213	Air inlet temperature (j1939-AMB) Value for Error indicator: FFFEh Value for Not available: FFFFh	°C	*1	All
50265	88	3-4	int16	15209	Actual engine torque (j1939-EEC1) Value for Error indicator: FFFEh Value for Not available: FFFFh	%	*1	All
50266	88	5-6	int16	15315	Aftertreatment 1 Diesel Exhaust Fluid Tank 2 Level	%	*10	All
50267	89	1-4	int32	15216	Exhaust Gas Temp.(J1939-IC1) Value for Error indicator: FFFFFFFEh Value for Not available: FFFFFFFFh	°C	*100	All
50269	89	5-6	int16	15316	Aftertreatment 1 Diesel Exhaust Fluid Tank 2 Temperature	°C	*1	All

9.2.2 Protocol 5004 (Generator Values Visualization)

CAN Mux	CAN Byte	Size	Index	Description	Unit	Scale	Model
0	1-2	uint16		Telegram-ID, always 5004			
0	3-4	int16	10100	Pickup speed	rpm	*1	All
0	5-6	int16	-	Internal			All
1	1-2	int16	160	Gen. powerfactor		*1000	All
1	3-6	int32	170	Av. Gen. Wye-Voltage	V	*10	All
2	1-2	int16	144	Gen. frequency	Hz	*100	All
2	3-6	int32	171	Av. Gen. Delta-Voltage	V	*10	All
3	1-2	int16	10310	Analog output 1	%	configurable	All
3	3-6	int32	185	Av. Gen. Current	A	*1000	All
4	1-2	int16	10311	Analog output 2	%	configurable	All
4	3-6	int32	161	Meas. ground current	A	*1000	All
5	1-2	uint16	10133	BITLIST Alarms 1 latched (unacknowledged)			
				05.01 Engine Over speed 1 latched		Mask: 8000h	All
				05.02 Engine Over speed 2 latched		Mask: 4000h	All
				05.03 Engine under speed 1 latched		Mask: 2000h	All
				05.04 Engine under speed 2 latched		Mask: 1000h	All
				05.05 Unintended stop detected latched		Mask: 0800h	All
				05.07 Speed detection alarm latched		Mask: 0400h	All

CAN Mux	CAN Byte	Size	Index	Description	Unit	Scale	Model
				05.06 Shutdown malfunction detected latched		Mask: 0200h	All
				08.05 GCB fail to close latched		Mask: 0100h	All
				08.06 GCB fail to open latched		Mask: 0080h	All
				08.07 MCB fail to close latched		Mask: 0040h	All
				08.08 MCB fail to open latched		Mask: 0020h	All
				08.10 General CAN-J1939 fault latched		Mask: 0010h	All
				05.08 Start fail detected latched		Mask: 0008h	All
				05.09 Maintenance days exceeded latched		Mask: 0004h	All
				05.10 Maintenance hours exceeded latched		Mask: 0002h	All
				08.18 CANopen error at CAN Interface 1		Mask: 0001h	All
5	3-6	int32	159	Calculated ground current	A	*1000	All
6	1-2	uint16	10149	BITLIST Alarms 2 latched (unacknowledged)			
				08.30 Timeout Synchronisation GCB latched		Mask: 8000h	All
				08.31 Timeout Synchronisation MCB latched		Mask: 4000h	All
				08.32 Timeout Synchronisation GGB latched		Mask: 2000h	EG3500XT-P1 EG3500XT-P2
				05.11 Charge fail (D+ functionality) latched		Mask: 1000h	All
				Operating range failure 12 latched		Mask: 0800h	All
				08.45 CPU overload R1 trip latched		Mask: 0400h	All
				08.47 MCB failure 50BF		Mask: 0200h	All
				08.46 GCB failure 50BF		Mask: 0100h	All
				05.22 ECU Protect alarm		Mask: 0080h	All
				05.23 ECU Emission alarm		Mask: 0040h	All
				08.19 CANopen error at CAN Interface 2		Mask: 0020h	All
				08.16 Parameter Alignment LDSS		Mask: 0010h	All
				08.17 Missing members		Mask: 0008h	All
				08.48 MCB plausibility		Mask: 0004h	All
				05.13 ECU red lamp alarm latched		Mask: 0002h	All
				05.14 ECU yellow (amber) lamp alarm latched		Mask: 0001h	All
6	3-6	int32	111	Gen. current 1	A	*1000	All
7	1-4	int32	112	Gen. current 2	A	*1000	All
7	5-6	int16		Internal			All
8	1-4	int32	113	Gen. current 3	A	*1000	All
8	5-6	int16		Internal			All
9	1-4	int32	135	Total gen. power	W	*1	All
9	5-6	uint16	10134	BITLIST Alarms Gen latched (unacknowledged)			

9 Appendix

9.2.2 Protocol 5004 (Generator Values Visualization)

CAN Mux	CAN Byte	Size	Index	Description	Unit	Scale	Model
				06.01 Generator over frequency 1 latched		Mask: 8000h	All
				06.02 Generator over frequency 2 latched		Mask: 4000h	All
				06.03 Generator under frequency 1 latched		Mask: 2000h	All
				06.04 Generator under frequency 2 latched		Mask: 1000h	All
				06.05 Generator over voltage 1 latched		Mask: 0800h	All
				06.06 Generator over voltage 2 latched		Mask: 0400h	All
				06.07 Generator under voltage 1 latched		Mask: 0200h	All
				06.08 Generator under voltage 2 latched		Mask: 0100h	All
				06.09 Generator over current 1 latched		Mask: 0080h	All
				06.10 Generator over current 2 latched		Mask: 0040h	All
				06.11 Generator over current 3 latched		Mask: 0020h	All
				06.12 Reverse / reduced power 1 latched		Mask: 0010h	All
				06.13 Reverse / reduced power 2 latched		Mask: 0008h	All
				06.14 Generator overload IOP 1 latched		Mask: 0004h	All
				06.15 Generator overload IOP 2 latched		Mask: 0002h	All
				06.34 Busbar phase rotation mismatch latched		Mask: 0001h	EG3500XT-P2
10	1-4	int32	136	Total gen. reactive power	var	*1	All
10	5-6	uint16	10138	BITLIST Alarms Gen 1 latched (unacknowledged)			
				06.16 Generator unbalanced load 1 latched		Mask: 8000h	All
				06.17 Generator unbalanced load 2 latched		Mask: 4000h	All
				06.18 Generator voltage asymmetry latched		Mask: 2000h	All
				06.19 Ground fault 1 latched		Mask: 1000h	All
				06.20 Ground fault 2 latched		Mask: 0800h	All
				06.21 Gen. Phase Rotation mismatch Latched		Mask: 0400h	All
				06.29 Gen. active power mismatch Latched		Mask: 0200h	All
				06.30 Generator unloading mismatch Latched		Mask: 0100h	All
				06.22 Inverse time over current Latched		Mask: 0080h	All
				06.31 Operating Range failed latched		Mask: 0040h	All
				06.23 Generator overload MOP 1 latched		Mask: 0020h	All
				06.24 Generator overload MOP 2 latched		Mask: 0010h	All
				06.25 Gen.Power Factor lagging 1 latched		Mask: 0008h	All
				06.26 Gen.Power Factor lagging 2 latched		Mask: 0004h	All
				06.27 Gen.Power Factor leading 1 latched		Mask: 0002h	All
				06.28 Gen.Power Factor leading 2 latched		Mask: 0001h	All
11	1-4	int32	108	Gen. voltage L1-L2	V	*10	All
11	5-6	uint16	10131	BITLIST Alarm General			

CAN Mux	CAN Byte	Size	Index	Description	Unit	Scale	Model
				01.11 New Alarm triggered		Mask: 8000h	All
				Internal		Mask: 4000h	
				Internal		Mask: 2000h	
				Internal		Mask: 1000h	
				Internal		Mask: 0800h	
				Internal		Mask: 0400h	
				Internal		Mask: 0200h	
				Internal		Mask: 0100h	
				Internal		Mask: 0080h	
				Internal		Mask: 0040h	
				01.06 Alarm class F latched		Mask: 0020h	All
				01.05 Alarm class E latched		Mask: 0010h	All
				01.04 Alarm class D latched		Mask: 0008h	All
				01.03 Alarm class C latched		Mask: 0004h	All
				01.02 Alarm class B latched		Mask: 0002h	All
				01.01 Alarm class A latched		Mask: 0001h	All
12	1-2	uint16	4153	BITLIST ControlBits1			
				Idle mode OR Ramp to rated active		Mask: 8000h	All
				04.15 Idle run is active		Mask: 4000h	All
				04.12 Start without closing GCB		Mask: 2000h	All
				04.64 Key activation		Mask: 1000h	All
				A manual START has been requested		Mask: 0800h	All
				A manual STOP has been requested		Mask: 0400h	All
				04.10 Cooldown is active		Mask: 0200h	All
				03.01 Auxiliary Services is active		Mask: 0100h	All
				03.07 Engine monitoring delay expired		Mask: 0080h	All
				03.08 Breaker delay timer has expired		Mask: 0040h	All
				03.25 Engine shall run		Mask: 0020h	All
				04.27 Critical mode is active		Mask: 0010h	All
				03.06 Engine release is active		Mask: 0008h	All
				03.30 Auxiliary services prerun is active		Mask: 0004h	All
				03.31 Auxiliary services postrun is active		Mask: 0002h	All
				04.61 Lamp test request		Mask: 0001h	All
12	3-6	int32	114	Gen. voltage L1-N	V	*10	All
13	1-4	int32	109	Gen. voltage L2-L3	V	*10	All
13	5-6	int16	-	Internal			All
14	1-4	int32	115	Gen. voltage L2-N	V	*10	All

9 Appendix

9.2.2 Protocol 5004 (Generator Values Visualization)

CAN Mux	CAN Byte	Size	Index	Description	Unit	Scale	Model
14	5-6	int16	-	Internal			All
15	1-4	int32	110	Gen. voltage L3-L1	V	*10	All
15	5-6	int16	-	Internal			All
16	1-4	int32	116	Gen. voltage 3-N	V	*10	All
16	5-6	int16	-	Internal			All
17	1-4	int32	2522	Positive reactive gen energy	Mvarh	*100	All
17	5-6	int16	-	Internal			All
18	1-2	int16	5541	Frequency setpoint	Hz	*100	All
18	3-6	int32	5542	Active Power setpoint	kW	*10	All
19	1-4	int32	5640	Voltage setpoint	V	*1	All
19	5-6	int16	5641	Power Factor setpoint		*1000	All
20	1-2	uint16	4154	BITLIST ControlBits2			
				03.02 Starter / Crank is active		Mask: 8000h	All
				03.28 Operating Magnet / Gasrelay is active		Mask: 4000h	All
				03.04 Preglow or Ignition is active		Mask: 2000h	All
				04.11 Mains settling		Mask: 1000h	All
				04.09 Emergency mode is currently active		Mask: 0800h	All
				03.40 Remote Shutdown (ID503, Bit9)		Mask: 0400h	All
				03.33 Free PID Controller 3: Lower Command		Mask: 0200h	All
				03.32 Free PID Controller 3: Raise Command		Mask: 0100h	All
				03.35 Free PID Controller 2: Lower Command		Mask: 0080h	All
				03.34 Free PID Controller 2: Raise Command		Mask: 0040h	All
				03.27 Stop solenoid is active		Mask: 0020h	All
				03.24 Excitation enabled (Run-up Synchronization)		Mask: 0010h	EG3500XT-P1 EG3500XT-P2
				The genset runs mains parallel		Mask: 0008h	All
				03.37 Free PID Controller 1: Lower Command		Mask: 0004h	All
				03.36 Free PID Controller 1: Raise Command		Mask: 0002h	All
				Increment Engine Start Counter		Mask: 0001h	All
20	3-4	uint16	4155	BITLIST ControlBits3			
				03.20 3-Pos. Controller Freq./Power raise		Mask: 8000h	All
				03.21 3-Pos. Controller Freq./Power lower		Mask: 4000h	All
				03.22 3-Pos. Controller Volt./ReactPow raise		Mask: 2000h	All
				03.23 3-Pos. Controller Volt./ReactPow lower		Mask: 1000h	All
				04.06 GCB is closed		Mask: 0800h	All
				04.07 MCB is closed		Mask: 0400h	All
				05.16 Derating active (J1939 or freely)		Mask: 0200h	All

CAN Mux	CAN Byte	Size	Index	Description	Unit	Scale	Model
				04.18 Synchronisation GCB procedure is active		Mask: 0100h	All
				04.19 Opening GCB relay is active		Mask: 0080h	All
				04.20 Close command GCB is active		Mask: 0040h	All
				04.21 Synchronisation MCB procedure is active		Mask: 0020h	All
				04.22 Open command MCB is active		Mask: 0010h	All
				04.23 Close command MCB is active		Mask: 0008h	All
				04.28 Unloading generator is active		Mask: 0004h	All
				04.29 Unloading mains is active		Mask: 0002h	All
				04.30 Power limited prerun		Mask: 0001h	All
20	5-6	uint16	4156	BITLIST ControlBits4			
				04.16 GGB is closed		Mask: 8000h	EG3500XT-P1 EG3500XT-P2
				04.17 GGB is released		Mask: 4000h	EG3500XT-P1 EG3500XT-P2
				04.24 Synchronisation GGB procedure is active		Mask: 2000h	EG3500XT-P1 EG3500XT-P2
				04.25 Open command GGB is active		Mask: 1000h	EG3500XT-P1 EG3500XT-P2
				04.26 Close command GGB is active		Mask: 0800h	EG3500XT-P1 EG3500XT-P2
				Dead busbar closure requ. for GCB,MCB or GGB		Mask: 0400h	All
				4.62 Active power load share is active		Mask: 0200h	All
				4.63 Reactive power load share is active		Mask: 0100h	All
				Generator with a closed GCB is requested		Mask: 0080h	All
				LDSS: The Engine shall start		Mask: 0040h	All
				LDSS: The Engine shall stop		Mask: 0020h	All
				LDSS: The Engine shall stop, if possible		Mask: 0010h	All
				LDSS: Minimum Running Time is active		Mask: 0008h	All
				04.43 The LDSS function is active		Mask: 0004h	All
				04.60 Critical mode postrun		Mask: 0002h	All
				AUTOMATIC Run: Switch to Operating Mode STOP		Mask: 0001h	All

9.2.3 Protocol 5005 (Mains Values Visualization)

CAN Mux	CAN Byte	Size	Index	Description	Unit	Scale	Model
0	1-2	int16		Protocol-ID (always 5005)			All
0	3-4	int16	10100	Pickup speed	rpm	*1	All
0	5-6	int16	-	Internal			
1	1-2	int16	147	Mains frequency	Hz	*100	All
1	3-6	int32	173	Av. Mains Wye-Voltage	V	*10	All
2	1-2	int16	208	Mains power factor		*1000	All
2	3-6	int32	174	Av. Mains Delta-Voltage	V	*10	All
3	1-4	int32	207	Av. Mains Current	V	*10	All
3	5-6	int16	-	Internal			
4	1-2	int16	10111	Analog input 1		configurable	All
4	3-6	int32	134	Mains current L1	A	*1000	All
5	1-2	int16	10112	Analog input 2		configurable	All
5	3-6	int32	140	Total mains power	W	*1	All
6	1-2	int16	10115	Analog input 3		configurable	All
6	3-6	int32	150	Total mains reactive power	var	*1	All
7	1-2	uint16	10135	BITLIST Alarms Mains latched (unacknowledged)			
				07.06 Mains over frequency 1 latched		Mask: 8000h	All
				07.07 Mains over frequency 2 latched		Mask: 4000h	All
				07.08 Mains under frequency 1 latched		Mask: 2000h	All
				07.09 Mains under frequency 2 latched		Mask: 1000h	All
				07.10 Mains over voltage 1 latched		Mask: 0800h	All
				07.11 Mains over voltage 2 latched		Mask: 0400h	All
				07.12 Mains under voltage 1 latched		Mask: 0200h	All
				07.13 Mains under voltage 2 latched		Mask: 0100h	All
				07.14 Mains Phase shift latched		Mask: 0080h	All
				07.25 Mains decoupling latched		Mask: 0040h	All
				07.32 Mains AC Wiring		Mask: 0020h	All
				Internal		Mask: 0010h	
				Internal		Mask: 0008h	
				07.05 Mains Phase rotation mismatch latched		Mask: 0004h	All
				Internal		Mask: 0002h	
				Internal		Mask: 0001h	
7	3-4	uint16	10278	BITLIST Alarms Mains 1 latched (unacknowledged)			
				07.21 Mains import power 1 latched		Mask: 8000h	All

CAN Mux	CAN Byte	Size	Index	Description	Unit	Scale	Model
				07.22 Mains import power 2 latched		Mask: 4000h	All
				07.23 Mains export power 1 latched		Mask: 2000h	All
				07.24 Mains export power 2 latched		Mask: 1000h	All
				07.17 Mains PF lagging 1 latched		Mask: 0800h	All
				07.18 Mains PF lagging 2 latched		Mask: 0400h	All
				07.19 Mains PF leading 1 latched		Mask: 0200h	All
				07.20 Mains PF leading 2 latched		Mask: 0100h	All
				07.15 Mains df/dt latched		Mask: 0080h	All
				07.16 Mains active power mismatch latched		Mask: 0040h	All
				07.28 Mains Time-dep. Voltage 1 (FRT) latched		Mask: 0020h	All
				07.33 Mains Time-dep. Voltage 3 (FRT) latched		Mask: 0010h	All
				07.27 Mains slow voltage increase (10 min)		Mask: 0008h	All
				07.31 Mains Time-dep. Voltage 2 (FRT) latched		Mask: 0004h	All
				07.29 Mains QV Monitoring step 1 latched		Mask: 0002h	All
				07.30 Mains QV Monitoring step 2 latched		Mask: 0001h	All
7	5-6	int16		Internal			
8	1-4	int32	118	Mains voltage L1-L2	V	*10	All
8	5-6	int16	-	Internal			
9	1-4	int32	121	Mains voltage L1-N	V	*10	All
9	5-6	int16	-	Internal			
10	1-4	int32	119	Mains voltage L2-L3	V	*10	All
10	5-6	int16	-	Internal			
11	1-4	int32	122	Mains voltage L2-N	V	*10	All
11	5-6	int16	-	Internal			
12	1-4	int32	120	Mains voltage L3-L1	V	*10	All
12	5-6	int16	-	Internal			
13	1-4	int32	123	Mains voltage L3-N	V	*10	All
13	5-6	int16	-	Internal			

9.2.4 Protocol 5010 (Basic Visualization)

Modbus-Address	Size	Index	Description	Unit	Scale	Model
50000	int16		Protocol-ID, always 5010			All
50001	int16	3181	Scaling Power (16 bits) Exponent $10^* W$ (5;4;3;2)			All

Modbus-Address	Size	Index	Description	Unit	Scale	Model
50002	int16	3182	Scaling Volts (16 bits) Exponent 10* V (2;1;0;-1)			All
50003	int16	3183	Scaling Amps (16 bits) Exponent 10* A (0;-1)			All
50004			Internal			
50005			Internal			
50006			Internal			
50007			Internal			
50008			Internal			
Topic AC Generator and Busbar values						
50009	int16	144	Generator frequency	Hz	*100	All
50010	int16	246	Total generator power	W	format defined by index 3181 (Modbus-Address 50001)	All
50011	int16	247	Total generator reactive power	var	format defined by index 3181 (Modbus-Address 50001)	All
50012	int16	160	Generator power factor		*1000	All
50013	int16	248	Generator voltage L1-L2	V	format defined by index 3182 (Modbus-Address 50002)	All
50014	int16	249	Generator voltage L2-L3	V	format defined by index 3182 (Modbus-Address 50002)	All
50015	int16	250	Generator voltage L3-L1	V	format defined by index 3182 (Modbus-Address 50002)	All
50016	int16	251	Generator voltage L1-N	V	format defined by index 3182 (Modbus-Address 50002)	All
50017	int16	252	Generator voltage L2-N	V	format defined by index 3182 (Modbus-Address 50002)	All
50018	int16	253	Generator voltage L3-N	V	format defined by index 3182	All

Modbus-Address	Size	Index	Description	Unit	Scale	Model
					(Modbus-Address 50002)	
50019	int16	255	Generator current 1	A	format defined by index 3183 (Modbus-Address 50003)	All
50020	int16	256	Generator current 2	A	format defined by index 3183 (Modbus-Address 50003)	All
50021	int16	257	Generator current 3	A	format defined by index 3183 (Modbus-Address 50003)	All
50022	int16	209	Busbar 1: Frequency	Hz	*100	All
50023	int16	254	Busbar 1: Voltage L1-L2	V	format defined by index 3182 (Modbus-Address 50002)	All
50024	int16	279	Busbar 1: Voltage L2-L3	V	format defined by index 3182 (Modbus-Address 50002)	EG3500XT-P2
50025	int16	280	Busbar 1: Voltage L3-L1	V	format defined by index 3182 (Modbus-Address 50002)	EG3500XT-P2
50026	int16		Internal			
50027	int16		Internal			
50028	int16	5541	Setpoint frequency	Hz	*1	All
50029	int16	5641	Setpoint power factor (cosphi)		*1	All
Topic AC Mains values						
50030	int16	147	Mains frequency	Hz	*100	All
50031	int16	258	Total mains power	W	format defined by index 3181 (Modbus-Address 50001)	All
50032	int16	259	Total mains reactive power	var	format defined by index 3181 (Modbus-Address 50001)	All

9 Appendix

9.2.4 Protocol 5010 (Basic Visualization)

Modbus-Address	Size	Index	Description	Unit	Scale	Model
50033	int16	208	Mains power factor		*1000	All
50034	int16	260	Mains voltage L1-L2	V	format defined by index 3182 (Modbus-Address 50002)	All
50035	int16	261	Mains voltage L2-L3	V	format defined by index 3182 (Modbus-Address 50002)	All
50036	int16	262	Mains voltage L3-L1	V	format defined by index 3182 (Modbus-Address 50002)	All
50037	int16	263	Mains voltage L1-N	V	format defined by index 3182 (Modbus-Address 50002)	All
50038	int16	264	Mains voltage L2-N	V	format defined by index 3182 (Modbus-Address 50002)	All
50039	int16	265	Mains voltage L3-N	V	format defined by index 3182 (Modbus-Address 50002)	All
50040	int16	266	Mains current L1	A	format defined by index 3183 (Modbus-Address 50003)	All
50041	int16		Internal			
50042	int16		Internal			
50043	int16	267	Average LSx Delta Mains voltage L-L	V	format defined by index 3182 (Modbus-Address 50002)	EG3500XT-P1 EG3500XT-P1
50044	int16	268	Average LSx Wye Mains voltage L-N	V	format defined by index 3182 (Modbus-Address 50002)	EG3500XT-P1 EG3500XT-P1
Topic AC System values						
50045	int16	239	Nominal real power in system	%	*100	All

Modbus-Address	Size	Index	Description	Unit	Scale	Model
50046	int16	240	Real power in system	%	*100	All
50047	int16	241	Reserve real power in system	%	*100	All
50048	int16	269	Active power LSx	W	format defined by index 3181 (Modbus-Address 50001)	EG3500XT-P1 EG3500XT-P1
50049	int16	270	Reactive power LSx	var	format defined by index 3181 (Modbus-Address 50001)	EG3500XT-P1 EG3500XT-P1
50050	int16	4608	Average LSx Mains delta frequency L-L	Hz	*100	EG3500XT-P1 EG3500XT-P1
Topic DC Analogue Values (Engine Values)						
50051	int16	10100	Engine Pickup speed	rpm	*1	All
50052	int16	10110	Battery voltage	V	*10	All
50053	int16	10159	AI Auxiliary excitation D+	V	*10	All
50054	int16	2540	Engine, number of startrequests		*1	All
50055	int16	2558	Hours until next maintenance	h	*1	All
50056	int16	10111	Analog input 1		configurable	All
50057	int16	10112	Analog input 2		configurable	All
50058	int16	10115	Analog input 3		configurable	All
50059	int16	10117	Analog input 4		configurable	EG3500XT-P2
50060	int16	10151	Analog input 5		configurable	EG3500XT-P2
50061	int16	10152	Analog input 6		configurable	EG3500XT-P2
50062	int16	10153	Analog input 7		configurable	EG3500XT-P2
50063	int16	10154	Analog input 8		configurable	EG3500XT-P2
50064	int16	10155	Analog input 9		configurable	EG3500XT-P2
50065	int16	10156	Analog input 10		configurable	EG3500XT-P2
50066	int16	10157	Analog input 11			
50067	int16	10158	Analog input 12			
50068	int16	10310	Analog output 1	%	configurable	All
50069	int16	10311	Analog output 2	%	configurable	All
50070	int16	10317	Analog output 3	%	configurable	EG3500XT-P2
50071	int16	10318	Analog output 4	%	configurable	EG3500XT-P2
50072	int16	10319	Analog output 5	%	configurable	EG3500XT-P2
50073	int16	10320	Analog output 6	%	configurable	EG3500XT-P2
50074	int16	10170	External Analog input 1		configurable	All
50075	int16	10171	External Analog input 2		configurable	All

Modbus-Address	Size	Index	Description	Unit	Scale	Model
50076	int16	10172	External Analog input 3		configurable	All
50077	int16	10173	External Analog input 4		configurable	All
50078	int16	10174	External Analog input 5		configurable	All
50079	int16	10175	External Analog input 6		configurable	All
50080	int16	10176	External Analog input 7		configurable	All
50081	int16	10177	External Analog input 8		configurable	All
50082	int16	10178	External Analog input 9		configurable	All
50083	int16	10179	External Analog input 10		configurable	All
50084	int16	10180	External Analog input 11		configurable	All
50085	int16	10181	External Analog input 12		configurable	All
50086	int16	10182	External Analog input 13		configurable	All
50087	int16	10183	External Analog input 14		configurable	All
50088	int16	10184	External Analog input 15		configurable	All
50089	int16	10185	External Analog input 16		configurable	All
50090	int16	10245	External Analog Output 1	%	configurable	All
50091	int16	10255	External Analog Output 2	%	configurable	All
50092	int16	10265	External Analog Output 3	%	configurable	All
50093	int16	10275	External Analog Output 4	%	configurable	All
50094	int16	2556	Days until next maintenance	days	*1	All
50095	int16		Internal			
50096	int16		Internal			
50097	int16		Internal			
50098	int16		Internal			
Topic Control and Status						
50099	int16		BITLIST			
			Control mode (STOP/AUTO/MANUAL/TEST) 1=AUTO - 04.01 Operation Mode Auto 2=STOP - 04.02 Operation Mode Stop 4=MANUAL - 04.03 Operation Mode Man 8=TEST - 04.03 Operation Mode Test		Mask: 000Fh	All
50100	int16	10202	Status message. This is an index number. Refer to manual chapter Status messages for more information.			All
50101	int16		Internal			
50102	int16	4153	BITLIST ControlBits1			
			Idle mode OR Ramp to rated active		Mask: 8000h	All
			04.15 Idle run is active		Mask: 4000h	All
			04.12 Start without closing GCB		Mask: 2000h	All

Modbus-Address	Size	Index	Description	Unit	Scale	Model
			04.64 Key activation		Mask: 1000h	All
			A manual START has been requested		Mask: 0800h	All
			A manual STOP has been requested		Mask: 0400h	All
			04.10 Cooldown is active		Mask: 0200h	All
			03.01 Auxiliary Services is active		Mask: 0100h	All
			03.07 Engine monitoring delay expired		Mask: 0080h	All
			03.08 Breaker delay timer has expired		Mask: 0040h	All
			03.25 Engine shall run		Mask: 0020h	All
			04.27 Critical mode is active		Mask: 0010h	All
			03.06 Engine release is active		Mask: 0008h	All
			03.30 Auxiliary services prerun is active		Mask: 0004h	All
			03.31 Auxiliary services postrun is active		Mask: 0002h	All
			04.61 Lamp test request		Mask: 0001h	All
50103	int16	4154	BITLIST ControlBits2			
			03.02 Starter / Crank is active		Mask: 8000h	All
			03.28 Operating Magnet / Gasrelay is active		Mask: 4000h	All
			03.04 Preglow or Ignition is active		Mask: 2000h	All
			04.11 Mains settling		Mask: 1000h	All
			04.09 Emergency mode is currently active		Mask: 0800h	All
			03.40 Remote Shutdown (ID503, Bit9)		Mask: 0400h	All
			03.33 Free PID Controller 3: Lower Command		Mask: 0200h	All
			03.32 Free PID Controller 3: Raise Command		Mask: 0100h	All
			03.35 Free PID Controller 2: Lower Command		Mask: 0080h	All
			03.34 Free PID Controller 2: Raise Command		Mask: 0040h	All
			03.27 Stop solenoid is active		Mask: 0020h	All
			03.24 Excitation enabled (Run-up Synchronization)		Mask: 0010h	EG3500XT-P1 EG3500XT-P2
			The genset runs mains parallel		Mask: 0008h	All
			03.37 Free PID Controller 1: Lower Command		Mask: 0004h	All
			03.36 Free PID Controller 1: Raise Command		Mask: 0002h	All
			Increment Engine Start Counter		Mask: 0001h	All
50104	int16	4155	BITLIST ControlBits3			
			03.20 3-Pos. Controller Freq./Power raise		Mask: 8000h	All
			03.21 3-Pos. Controller Freq./Power lower		Mask: 4000h	All
			03.22 3-Pos. Controller Volt./ReactPow raise		Mask: 2000h	All
			03.23 3-Pos. Controller Volt./ReactPow lower		Mask: 1000h	All
			04.06 GCB is closed		Mask: 0800h	All

Modbus-Address	Size	Index	Description	Unit	Scale	Model
			04.07 MCB is closed		Mask: 0400h	All
			05.16 Derating active (J1939 or freely)		Mask: 0200h	All
			04.18 Synchronisation GCB procedure is active		Mask: 0100h	All
			04.19 Opening GCB relay is active		Mask: 0080h	All
			04.20 Close command GCB is active		Mask: 0040h	All
			04.21 Synchronisation MCB procedure is active		Mask: 0020h	All
			04.22 Open command MCB is active		Mask: 0010h	All
			04.23 Close command MCB is active		Mask: 0008h	All
			04.28 Unloading generator is active		Mask: 0004h	All
			04.29 Unloading mains is active		Mask: 0002h	All
			04.30 Power limited prerun		Mask: 0001h	All
50105	int16	4156	BITLIST ControlBits4			
			04.16 GGB is closed		Mask: 8000h	EG3500XT-P1 EG3500XT-P2
			04.17 GGB is released		Mask: 4000h	EG3500XT-P1 EG3500XT-P2
			04.24 Synchronisation GGB procedure is active		Mask: 2000h	EG3500XT-P1 EG3500XT-P2
			04.25 Open command GGB is active		Mask: 1000h	EG3500XT-P1 EG3500XT-P2
			04.26 Close command GGB is active		Mask: 0800h	EG3500XT-P1 EG3500XT-P2
			Dead busbar closure requ. for GCB,MCB or GGB		Mask: 0400h	All
			4.62 Active power load share is active		Mask: 0200h	All
			4.63 Reactive power load share is active		Mask: 0100h	All
			Generator with a closed GCB is requested		Mask: 0080h	All
			LDSS: The Engine shall start		Mask: 0040h	All
			LDSS: The Engine shall stop		Mask: 0020h	All
			LDSS: The Engine shall stop, if possible		Mask: 0010h	All
			LDSS: Minimum Running Time is active		Mask: 0008h	All
			04.43 The LDSS function is active		Mask: 0004h	All
			04.60 Critical mode postrun		Mask: 0002h	All
			AUTOMATIC Run: Switch to Operating Mode STOP		Mask: 0001h	All
50106	int16	4150	BITLIST ControlBits5			
			04.13 Remote Start request		Mask: 8000h	All

Modbus-Address	Size	Index	Description	Unit	Scale	Model
			04.14 Remote acknowledge		Mask: 4000h	All
			05.17 Uprating active		Mask: 2000h	All
			86.25 LM Frequency Droop active		Mask: 1000h	All
			86.26 LM Voltage Droop active		Mask: 0800h	All
			Synchronization mode Check active		Mask: 0400h	All
			Synchronization mode Permissive active		Mask: 0200h	All
			Synchronization mode Run active		Mask: 0100h	All
			86.85 LM Enable MCB		Mask: 0080h	All
			86.41 LDSS IOP Reserve power 2 ready		Mask: 0040h	All
			86.42 LDSS MOP Reserve power 2 ready		Mask: 0020h	All
			02.39 Mains decoupling enabled		Mask: 0010h	All
			04.70 Opening GCB active		Mask: 0008h	All
			Parameter set 1-7 selection Bit 3		Mask: 0004h	Rental
			Parameter set 1-7 selection Bit 2		Mask: 0002h	Rental
			Parameter set 1-7 selection Bit 1		Mask: 0001h	Rental
50107	int16		Internal			
Topic Discrete Outputs						
50108	int16	10107	BITLIST Relay Outputs 1			
			13.01 Relay-Output 1 (Self-test-relay)		Mask: 8000h	All
			13.02 Relay-Output 2		Mask: 4000h	All
			13.03 Relay-Output 3		Mask: 2000h	All
			13.04 Relay-Output 4		Mask: 1000h	All
			13.05 Relay-Output 5		Mask: 0800h	All
			13.06 Relay-Output 6		Mask: 0400h	All
			13.07 Relay-Output 7		Mask: 0200h	All
			13.08 Relay-Output 8		Mask: 0100h	All
			13.09 Relay-Output 9		Mask: 0080h	All
			13.10 Relay-Output 10		Mask: 0040h	All
			13.11 Relay-Output 11		Mask: 0020h	All
			13.12 Relay-Output 12		Mask: 0010h	All
			Internal		Mask: 0008h	All
			Internal		Mask: 0004h	All
			Internal		Mask: 0002h	All
			Internal		Mask: 0001h	All
50109	int16	10109	BITLIST Relay Outputs 2			
			13.13 Relay-Output 13		Mask: 8000h	EG3500XT-P2
			13.14 Relay-Output 14		Mask: 4000h	EG3500XT-P2

Modbus-Address	Size	Index	Description	Unit	Scale	Model
			13.15 Relay-Output 15		Mask: 2000h	EG3500XT-P2
			13.16 Relay-Output 16		Mask: 1000h	EG3500XT-P2
			13.17 Relay-Output 17		Mask: 0800h	EG3500XT-P2
			13.18 Relay-Output 18		Mask: 0400h	EG3500XT-P2
			13.19 Relay-Output 19		Mask: 0200h	EG3500XT-P2
			13.20 Relay-Output 20		Mask: 0100h	EG3500XT-P2
			13.21 Relay-Output 21		Mask: 0080h	EG3500XT-P2
			13.22 Relay-Output 22		Mask: 0040h	EG3500XT-P2
			Internal		Mask: 0020h	All
			Internal		Mask: 0010h	All
			Internal		Mask: 0008h	All
			Internal		Mask: 0004h	All
			13.34 Transistor output 2		Mask: 0002h	EG3500XT-P2
			13.33 Transistor output 1		Mask: 0001h	EG3500XT-P2
50110	int16	8005	BITLIST Relay Outputs 3			
			98.16 LM External DO 16		Mask: 8000h	All
			98.15 LM External DO 15		Mask: 4000h	All
			98.14 LM External DO 14		Mask: 2000h	All
			98.13 LM External DO 13		Mask: 1000h	All
			98.12 LM External DO 12		Mask: 0800h	All
			98.11 LM External DO 11		Mask: 0400h	All
			98.10 LM External DO 10		Mask: 0200h	All
			98.09 LM External DO 9		Mask: 0100h	All
			98.08 LM External DO 8		Mask: 0080h	All
			98.07 LM External DO 7		Mask: 0040h	All
			98.06 LM External DO 6		Mask: 0020h	All
			98.05 LM External DO 5		Mask: 0010h	All
			98.04 LM External DO 4		Mask: 0008h	All
			98.03 LM External DO 3		Mask: 0004h	All
			98.02 LM External DO 2		Mask: 0002h	All
			98.01 LM External DO 1		Mask: 0001h	All
50111	int16	8009	BITLIST Relay Outputs 4			
			98.32 LM External DO 32		Mask: 8000h	All
			98.31 LM External DO 31		Mask: 4000h	All
			98.30 LM External DO 30		Mask: 2000h	All
			98.29 LM External DO 29		Mask: 1000h	All
			98.28 LM External DO 28		Mask: 0800h	All

Modbus-Address	Size	Index	Description	Unit	Scale	Model
			98.27 LM External DO 27		Mask: 0400h	All
			98.26 LM External DO 26		Mask: 0200h	All
			98.25 LM External DO 25		Mask: 0100h	All
			98.24 LM External DO 24		Mask: 0080h	All
			98.23 LM External DO 23		Mask: 0040h	All
			98.22 LM External DO 22		Mask: 0020h	All
			98.21 LM External DO 21		Mask: 0010h	All
			98.20 LM External DO 20		Mask: 0008h	All
			98.19 LM External DO 19		Mask: 0004h	All
			98.18 LM External DO 18		Mask: 0002h	All
			98.17 LM External DO 17		Mask: 0001h	All
50112	int16	4157	BITLIST ControlBits6			
			28.01 Command 1 to LSx (OR)		Mask: 8000h	EG3500XT-P1 EG3500XT-P2
			28.02 Command 2 to LSx (OR)		Mask: 4000h	EG3500XT-P1 EG3500XT-P2
			28.03 Command 3 to LSx (OR)		Mask: 2000h	EG3500XT-P1 EG3500XT-P2
			28.04 Command 4 to LSx (OR)		Mask: 1000h	EG3500XT-P1 EG3500XT-P2
			28.05 Command 5 to LSx (OR)		Mask: 0800h	EG3500XT-P1 EG3500XT-P2
			28.06 Command 6 to LSx (OR)		Mask: 0400h	EG3500XT-P1 EG3500XT-P2
			02.38 Gen excitation limit active		Mask: 0200h	All
			03.39 Neutral interlocking - Closed NC		Mask: 0100h	All
			05.17 Uprating active		Mask: 0080h	All
			Extended Busbar F okay		Mask: 0040h	Marine
			Extended Busbar V okay		Mask: 0020h	Marine
			Extended Busbar F/V okay		Mask: 0010h	Marine
			Extended Busbar is dead		Mask: 0008h	Marine
			Phaseangle MNS/BUS okay		Mask: 0004h	Marine
			Phaseangle GEN/BUS okay		Mask: 0002h	Marine
			03.38 Inhibit cranking		Mask: 0001h	All
50113	int16		Internal			
Topic Alarm Management						

Modbus-Address	Size	Index	Description	Unit	Scale	Model
Subtopic General						
50114	int16	10131	BITLIST Alarm General			
			01.11 New Alarm triggered		Mask: 8000h	All
			Internal		Mask: 4000h	
			Internal		Mask: 2000h	
			Internal		Mask: 1000h	
			Internal		Mask: 0800h	
			Internal		Mask: 0400h	
			Internal		Mask: 0200h	
			Internal		Mask: 0100h	
			Internal		Mask: 0080h	
			Internal		Mask: 0040h	
			01.06 Alarm class F latched		Mask: 0020h	All
			01.05 Alarm class E latched		Mask: 0010h	All
			01.04 Alarm class D latched		Mask: 0008h	All
			01.03 Alarm class C latched		Mask: 0004h	All
			01.02 Alarm class B latched		Mask: 0002h	All
			01.01 Alarm class A latched		Mask: 0001h	All
50115	int16	10149	BITLIST Alarms 2 latched (unacknowledged)			
			08.30 Timeout Synchronisation GCB latched		Mask: 8000h	All
			08.31 Timeout Synchronisation MCB latched		Mask: 4000h	All
			08.32 Timeout Synchronisation GGB latched		Mask: 2000h	EG3500XT-P1 EG3500XT-P2
			05.11 Charge fail (D+ functionality) latched		Mask: 1000h	All
			Operating range failure 12 latched		Mask: 0800h	All
			08.45 CPU overload R1 trip latched		Mask: 0400h	All
			08.47 MCB failure 50BF		Mask: 0200h	All
			08.46 GCB failure 50BF		Mask: 0100h	All
			05.22 ECU Protect alarm		Mask: 0080h	All
			05.23 ECU Emission alarm		Mask: 0040h	All
			08.19 CANopen error at CAN Interface 2		Mask: 0020h	All
			08.16 Parameter Alignment LDSS		Mask: 0010h	All
			08.17 Missing members		Mask: 0008h	All
			08.48 MCB plausibility		Mask: 0004h	All
			05.13 ECU red lamp alarm latched		Mask: 0002h	All
			05.14 ECU yellow (amber) lamp alarm latched		Mask: 0001h	All
50116	int16	4169	Alarms 2 active (reserved)			

Modbus-Address	Size	Index	Description	Unit	Scale	Model
			Internal		Mask: 8000h	
			Internal		Mask: 4000h	
			Internal		Mask: 2000h	
			Internal		Mask: 1000h	
			Internal		Mask: 0800h	
			Internal		Mask: 0400h	
			Internal		Mask: 0200h	
			Internal		Mask: 0100h	
			Internal		Mask: 0080h	
			Internal		Mask: 0040h	
			Internal		Mask: 0020h	
			Internal		Mask: 0010h	
			Internal		Mask: 0008h	
			Internal		Mask: 0004h	
			Internal		Mask: 0002h	
			Internal		Mask: 0001h	
50117	int16	10190	BITLIST Alarms 3 latched (unacknowledged)			
			08.34 GGB fail to close latched		Mask: 8000h	EG3500XT-P1 EG3500XT-P2
			08.35 GGB fail to open latched		Mask: 4000h	EG3500XT-P1 EG3500XT-P2
			08.27 Missing easYgen		Mask: 2000h	All
			08.28 Missing LS5		Mask: 1000h	EG3500XT-P1 EG3500XT-P2
			05.18 Cylinder temperature level 1		Mask: 0800h	All
			05.19 Cylinder temperature level 2		Mask: 0400h	All
			05.20 Cylinder temperature wire break		Mask: 0200h	All
			6.35 Pole slip		Mask: 0100h	All
			08.44 Syst.update LS5		Mask: 0080h	EG3500XT-P1 EG3500XT-P2
			08.43 Syst.update easYgen		Mask: 0040h	All
			06.32 Gen.AC Wiring		Mask: 0020h	All
			06.33 Busbar1 AC Wiring		Mask: 0010h	EG3500XT-P2
			Internal		Mask: 0008h	
			Internal		Mask: 0004h	
			Internal		Mask: 0002h	

Modbus-Address	Size	Index	Description	Unit	Scale	Model
			Internal		Mask: 0001h	
50118	int16	4193	Alarms 3 active (reserved)			
			Internal		Mask: 8000h	
			Internal		Mask: 4000h	
			Internal		Mask: 2000h	
			Internal		Mask: 1000h	
			Internal		Mask: 0800h	
			Internal		Mask: 0400h	
			Internal		Mask: 0200h	
			Internal		Mask: 0100h	
			Internal		Mask: 0080h	
			Internal		Mask: 0040h	
			Internal		Mask: 0020h	
			Internal		Mask: 0010h	
			Internal		Mask: 0008h	
			Internal		Mask: 0004h	
			Internal		Mask: 0002h	
			Internal		Mask: 0001h	
50119	int16		Internal			
Subtopic Engine						
50120	int16	10133	BITLIST Alarms 1 latched (unacknowledged)			
			05.01 Engine Over speed 1 latched		Mask: 8000h	All
			05.02 Engine Over speed 2 latched		Mask: 4000h	All
			05.03 Engine under speed 1 latched		Mask: 2000h	All
			05.04 Engine under speed 2 latched		Mask: 1000h	All
			05.05 Unintended stop detected latched		Mask: 0800h	All
			05.07 Speed detection alarm latched		Mask: 0400h	All
			05.06 Shutdown malfunction detected latched		Mask: 0200h	All
			08.05 GCB fail to close latched		Mask: 0100h	All
			08.06 GCB fail to open latched		Mask: 0080h	All
			08.07 MCB fail to close latched		Mask: 0040h	All
			08.08 MCB fail to open latched		Mask: 0020h	All
			08.10 General CAN-J1939 fault latched		Mask: 0010h	All
			05.08 Start fail detected latched		Mask: 0008h	All
			05.09 Maintenance days exceeded latched		Mask: 0004h	All
			05.10 Maintenance hours exceeded latched		Mask: 0002h	All
			08.18 CANopen error at CAN Interface 1		Mask: 0001h	All

Modbus-Address	Size	Index	Description	Unit	Scale	Model
50121	int16	4167	Alarms 1 active (reserved)			
			Internal		Mask: 8000h	
			Internal		Mask: 4000h	
			Internal		Mask: 2000h	
			Internal		Mask: 1000h	
			Internal		Mask: 0800h	
			Internal		Mask: 0400h	
			Internal		Mask: 0200h	
			Internal		Mask: 0100h	
			Internal		Mask: 0080h	
			Internal		Mask: 0040h	
			Internal		Mask: 0020h	
			Internal		Mask: 0010h	
			Internal		Mask: 0008h	
			Internal		Mask: 0004h	
			Internal		Mask: 0002h	
			Internal		Mask: 0001h	
50122	int16	10136	BITLIST Alarms AI 1 latched (unacknowledged)			
			Internal		Mask: 8000h	
			Internal		Mask: 4000h	
			Internal		Mask: 2000h	
			Internal		Mask: 1000h	
			Internal		Mask: 0800h	
			Internal		Mask: 0400h	
			Internal		Mask: 0200h	
			Internal		Mask: 0100h	
			Internal		Mask: 0080h	
			Internal		Mask: 0040h	
			Internal		Mask: 0020h	
			05.11 Failure Charging Alternator (D+)		Mask: 0010h	All
			08.02 Battery over voltage 2 latched		Mask: 0008h	All
			08.04 Battery under voltage 2 latched		Mask: 0004h	All
			08.01 Battery over voltage 1 latched		Mask: 0002h	All
			08.03 Battery under voltage 1 latched		Mask: 0001h	All
50123	int16	4171	Alarms Analog Inputs 1 active (reserved)			
			Internal		Mask: 8000h	
			Internal		Mask: 4000h	

Modbus-Address	Size	Index	Description	Unit	Scale	Model
			Internal		Mask: 2000h	
			Internal		Mask: 1000h	
			Internal		Mask: 0800h	
			Internal		Mask: 0400h	
			Internal		Mask: 0200h	
			Internal		Mask: 0100h	
			Internal		Mask: 0080h	
			Internal		Mask: 0040h	
			Internal		Mask: 0020h	
			Internal		Mask: 0010h	
			Internal		Mask: 0008h	
			Internal		Mask: 0004h	
			Internal		Mask: 0002h	
			Internal		Mask: 0001h	
50124	int16		Internal			
50125	int16		Internal			
Subtopic Generator						
50126	int16	10134	BITLIST Alarms Gen latched (unacknowledged)			
			06.01 Generator over frequency 1 latched		Mask: 8000h	All
			06.02 Generator over frequency 2 latched		Mask: 4000h	All
			06.03 Generator under frequency 1 latched		Mask: 2000h	All
			06.04 Generator under frequency 2 latched		Mask: 1000h	All
			06.05 Generator over voltage 1 latched		Mask: 0800h	All
			06.06 Generator over voltage 2 latched		Mask: 0400h	All
			06.07 Generator under voltage 1 latched		Mask: 0200h	All
			06.08 Generator under voltage 2 latched		Mask: 0100h	All
			06.09 Generator over current 1 latched		Mask: 0080h	All
			06.10 Generator over current 2 latched		Mask: 0040h	All
			06.11 Generator over current 3 latched		Mask: 0020h	All
			06.12 Reverse / reduced power 1 latched		Mask: 0010h	All
			06.13 Reverse / reduced power 2 latched		Mask: 0008h	All
			06.14 Generator overload IOP 1 latched		Mask: 0004h	All
			06.15 Generator overload IOP 2 latched		Mask: 0002h	All
			06.34 Busbar phase rotation mismatch latched		Mask: 0001h	EG3500XT-P2
50127	int16	4161	Alarms Generator active (reserved)			
			Internal		Mask: 8000h	
			Internal		Mask: 4000h	

Modbus-Address	Size	Index	Description	Unit	Scale	Model
			Internal		Mask: 2000h	
			Internal		Mask: 1000h	
			Internal		Mask: 0800h	
			Internal		Mask: 0400h	
			Internal		Mask: 0200h	
			Internal		Mask: 0100h	
			Internal		Mask: 0080h	
			Internal		Mask: 0040h	
			Internal		Mask: 0020h	
			Internal		Mask: 0010h	
			Internal		Mask: 0008h	
			Internal		Mask: 0004h	
			Internal		Mask: 0002h	
			Internal		Mask: 0001h	
50128	int16	10138	BITLIST Alarms Gen 1 latched (unacknowledged)			
			06.16 Generator unbalanced load 1 latched		Mask: 8000h	All
			06.17 Generator unbalanced load 2 latched		Mask: 4000h	All
			06.18 Generator voltage asymmetry latched		Mask: 2000h	All
			06.19 Ground fault 1 latched		Mask: 1000h	All
			06.20 Ground fault 2 latched		Mask: 0800h	All
			06.21 Gen. Phase Rotation mismatch Latched		Mask: 0400h	All
			06.29 Gen. active power mismatch Latched		Mask: 0200h	All
			06.30 Generator unloading mismatch Latched		Mask: 0100h	All
			06.22 Inverse time over current Latched		Mask: 0080h	All
			06.31 Operating Range failed latched		Mask: 0040h	All
			06.23 Generator overload MOP 1 latched		Mask: 0020h	All
			06.24 Generator overload MOP 2 latched		Mask: 0010h	All
			06.25 Gen.Power Factor lagging 1 latched		Mask: 0008h	All
			06.26 Gen.Power Factor lagging 2 latched		Mask: 0004h	All
			06.27 Gen.Power Factor leading 1 latched		Mask: 0002h	All
			06.28 Gen.Power Factor leading 2 latched		Mask: 0001h	All
50129	int16	4163	Alarms Generator 1 active (reserved)			
			Internal		Mask: 8000h	
			Internal		Mask: 4000h	
			Internal		Mask: 2000h	
			Internal		Mask: 1000h	
			Internal		Mask: 0800h	

Modbus-Address	Size	Index	Description	Unit	Scale	Model
			Internal		Mask: 0400h	
			Internal		Mask: 0200h	
			Internal		Mask: 0100h	
			Internal		Mask: 0080h	
			Internal		Mask: 0040h	
			Internal		Mask: 0020h	
			Internal		Mask: 0010h	
			Internal		Mask: 0008h	
			Internal		Mask: 0004h	
			Internal		Mask: 0002h	
			Internal		Mask: 0001h	
50130	int16		Internal			
50131	int16		Internal			
Subtopic Mains						
50132	int16	10135	BITLIST Alarms Mains latched (unacknowledged)			
			07.06 Mains over frequency 1 latched		Mask: 8000h	All
			07.07 Mains over frequency 2 latched		Mask: 4000h	All
			07.08 Mains under frequency 1 latched		Mask: 2000h	All
			07.09 Mains under frequency 2 latched		Mask: 1000h	All
			07.10 Mains over voltage 1 latched		Mask: 0800h	All
			07.11 Mains over voltage 2 latched		Mask: 0400h	All
			07.12 Mains under voltage 1 latched		Mask: 0200h	All
			07.13 Mains under voltage 2 latched		Mask: 0100h	All
			07.14 Mains Phase shift latched		Mask: 0080h	All
			07.25 Mains decoupling latched		Mask: 0040h	All
			07.32 Mains AC Wiring		Mask: 0020h	All
			Internal		Mask: 0010h	
			Internal		Mask: 0008h	
			07.05 Mains Phase rotation mismatch latched		Mask: 0004h	All
			Internal		Mask: 0002h	
			Internal		Mask: 0001h	
50133	int16	4188	BITLIST Alarms Mains active			
			Mains over frequency 1		Mask: 8000h	All
			Mains over frequency 2		Mask: 4000h	All
			Mains under frequency 1		Mask: 2000h	All
			Mains under frequency 2		Mask: 1000h	All
			Mains over voltage 1		Mask: 0800h	All

Modbus-Address	Size	Index	Description	Unit	Scale	Model
			Mains over voltage 2		Mask: 0400h	All
			Mains under voltage 1		Mask: 0200h	All
			Mains under voltage 2		Mask: 0100h	All
			Mains Phase shift		Mask: 0080h	All
			Mains decoupling		Mask: 0040h	All
			Mains AC Wiring		Mask: 0020h	All
			Internal		Mask: 0010h	
			Internal		Mask: 0008h	
			Mains Phase rotation mismatch		Mask: 0004h	All
			Internal		Mask: 0002h	
			Internal		Mask: 0001h	
50134	int16	10278	BITLIST Alarms Mains 1 latched (unacknowledged)			
			07.21 Mains import power 1 latched		Mask: 8000h	All
			07.22 Mains import power 2 latched		Mask: 4000h	All
			07.23 Mains export power 1 latched		Mask: 2000h	All
			07.24 Mains export power 2 latched		Mask: 1000h	All
			07.17 Mains PF lagging 1 latched		Mask: 0800h	All
			07.18 Mains PF lagging 2 latched		Mask: 0400h	All
			07.19 Mains PF leading 1 latched		Mask: 0200h	All
			07.20 Mains PF leading 2 latched		Mask: 0100h	All
			07.15 Mains df/dt latched		Mask: 0080h	All
			07.16 Mains active power mismatch latched		Mask: 0040h	All
			07.28 Mains Time-dep. Voltage 1 (FRT) latched		Mask: 0020h	All
			07.33 Mains Time-dep. Voltage 3 (FRT) latched		Mask: 0010h	All
			07.27 Mains slow voltage increase (10 min)		Mask: 0008h	All
			07.31 Mains Time-dep. Voltage 2 (FRT) latched		Mask: 0004h	All
			07.29 Mains QV Monitoring step 1 latched		Mask: 0002h	All
			07.30 Mains QV Monitoring step 2 latched		Mask: 0001h	All
50135	int16	4187	Alarms Mains 1 active (reserved)			
			Internal		Mask: 8000h	
			Internal		Mask: 4000h	
			Internal		Mask: 2000h	
			Internal		Mask: 1000h	
			Internal		Mask: 0800h	
			Internal		Mask: 0400h	
			Internal		Mask: 0200h	
			Internal		Mask: 0100h	

Modbus-Address	Size	Index	Description	Unit	Scale	Model
			Internal		Mask: 0080h	
			Internal		Mask: 0040h	
			Internal		Mask: 0020h	
			Internal		Mask: 0010h	
			Internal		Mask: 0008h	
			Internal		Mask: 0004h	
			Internal		Mask: 0002h	
			Internal		Mask: 0001h	
50136	int16		Internal			
50137	int16		Internal			
Subtopic Digital Inputs						
50138	int16	10132	BITLIST Alarms DI 1 latched (unacknowledged)			
			09.01 Discrete input 1 latched		Mask: 8000h	All
			09.02 Discrete input 2 latched		Mask: 4000h	All
			09.03 Discrete input 3 latched		Mask: 2000h	All
			09.04 Discrete input 4 latched		Mask: 1000h	All
			09.05 Discrete input 5 latched		Mask: 0800h	All
			09.06 Discrete input 6 latched		Mask: 0400h	All
			09.07 Discrete input 7 latched		Mask: 0200h	All
			09.08 Discrete input 8 latched		Mask: 0100h	All
			09.09 Discrete input 9 latched		Mask: 0080h	All
			09.10 Discrete input 10 latched		Mask: 0040h	All
			09.11 Discrete input 11 latched		Mask: 0020h	All
			09.12 Discrete input 12 latched		Mask: 0010h	All
			Internal		Mask: 0008h	
			Internal		Mask: 0004h	
			Internal		Mask: 0002h	
			Internal		Mask: 0001h	
50139	int16	4181	Alarms Digital Inputs 1 active (reserved)			
			Internal		Mask: 8000h	
			Internal		Mask: 4000h	
			Internal		Mask: 2000h	
			Internal		Mask: 1000h	
			Internal		Mask: 0800h	
			Internal		Mask: 0400h	
			Internal		Mask: 0200h	
			Internal		Mask: 0100h	

Modbus-Address	Size	Index	Description	Unit	Scale	Model
			Internal		Mask: 0080h	
			Internal		Mask: 0040h	
			Internal		Mask: 0020h	
			Internal		Mask: 0010h	
			Internal		Mask: 0008h	
			Internal		Mask: 0004h	
			Internal		Mask: 0002h	
			Internal		Mask: 0001h	
50140	int16	16377	BITLIST Alarms Ext. DI 1 latched (unacknowledged)			
			12.16 External discrete input 16 latched		Mask: 8000h	All
			12.15 External discrete input 15 latched		Mask: 4000h	All
			12.14 External discrete input 14 latched		Mask: 2000h	All
			12.13 External discrete input 13 latched		Mask: 1000h	All
			12.12 External discrete input 12 latched		Mask: 0800h	All
			12.11 External discrete input 11 latched		Mask: 0400h	All
			12.10 External discrete input 10 latched		Mask: 0200h	All
			12.09 External discrete input 9 latched		Mask: 0100h	All
			12.08 External discrete input 8 latched		Mask: 0080h	All
			12.07 External discrete input 7 latched		Mask: 0040h	All
			12.06 External discrete input 6 latched		Mask: 0020h	All
			12.05 External discrete input 5 latched		Mask: 0010h	All
			12.04 External discrete input 4 latched		Mask: 0008h	All
			12.03 External discrete input 3 latched		Mask: 0004h	All
			12.02 External discrete input 2 latched		Mask: 0002h	All
			12.01 External discrete input 1 latched		Mask: 0001h	All
50141	int16	4185	Alarms External Digital Inputs active (reserved)			
			Internal		Mask: 8000h	
			Internal		Mask: 4000h	
			Internal		Mask: 2000h	
			Internal		Mask: 1000h	
			Internal		Mask: 0800h	
			Internal		Mask: 0400h	
			Internal		Mask: 0200h	
			Internal		Mask: 0100h	
			Internal		Mask: 0080h	
			Internal		Mask: 0040h	

9 Appendix

9.2.4 Protocol 5010 (Basic Visualization)

Modbus-Address	Size	Index	Description	Unit	Scale	Model
			Internal		Mask: 0020h	
			Internal		Mask: 0010h	
			Internal		Mask: 0008h	
			Internal		Mask: 0004h	
			Internal		Mask: 0002h	
			Internal		Mask: 0001h	
50142	int16	10284	BITLIST Alarm Ext. DI 2 latched (unacknowledged)			
			12.32 External discrete input 32 latched		Mask: 8000h	All
			12.31 External discrete input 31 latched		Mask: 4000h	All
			12.30 External discrete input 30 latched		Mask: 2000h	All
			12.29 External discrete input 29 latched		Mask: 1000h	All
			12.28 External discrete input 28 latched		Mask: 0800h	All
			12.27 External discrete input 27 latched		Mask: 0400h	All
			12.26 External discrete input 26 latched		Mask: 0200h	All
			12.25 External discrete input 25 latched		Mask: 0100h	All
			12.24 External discrete input 24 latched		Mask: 0080h	All
			12.23 External discrete input 23 latched		Mask: 0040h	All
			12.22 External discrete input 22 latched		Mask: 0020h	All
			12.21 External discrete input 21 latched		Mask: 0010h	All
			12.20 External discrete input 20 latched		Mask: 0008h	All
			12.19 External discrete input 19 latched		Mask: 0004h	All
			12.18 External discrete input 18 latched		Mask: 0002h	All
			12.17 External discrete input 17 latched		Mask: 0001h	All
50143	int16	4195	Alarm External Digital Inputs 1 active (reserved)			
			Internal		Mask: 8000h	
			Internal		Mask: 4000h	
			Internal		Mask: 2000h	
			Internal		Mask: 1000h	
			Internal		Mask: 0800h	
			Internal		Mask: 0400h	
			Internal		Mask: 0200h	
			Internal		Mask: 0100h	
			Internal		Mask: 0080h	
			Internal		Mask: 0040h	
			Internal		Mask: 0020h	
			Internal		Mask: 0010h	

Modbus-Address	Size	Index	Description	Unit	Scale	Model
			Internal		Mask: 0008h	
			Internal		Mask: 0004h	
			Internal		Mask: 0002h	
			Internal		Mask: 0001h	
50144	int16	10283	BITLIST Alarms DI 2 latched (unacknowledged)			
			09.13 Discrete input 13 latched		Mask: 8000h	EG3500XT-P2
			09.14 Discrete input 14 latched		Mask: 4000h	EG3500XT-P2
			09.15 Discrete input 15 latched		Mask: 2000h	EG3500XT-P2
			09.16 Discrete input 16 latched		Mask: 1000h	EG3500XT-P2
			09.17 Discrete input 17 latched		Mask: 0800h	EG3500XT-P2
			09.18 Discrete input 18 latched		Mask: 0400h	EG3500XT-P2
			09.19 Discrete input 19 latched		Mask: 0200h	EG3500XT-P2
			09.20 Discrete input 20 latched		Mask: 0100h	EG3500XT-P2
			09.21 Discrete input 21 latched		Mask: 0080h	EG3500XT-P2
			09.22 Discrete input 22 latched		Mask: 0040h	EG3500XT-P2
			09.23 Discrete input 23 latched		Mask: 0020h	EG3500XT-P2
			Internal		Mask: 0010h	
			Internal		Mask: 0008h	
			Internal		Mask: 0004h	
			Internal		Mask: 0002h	
			Internal		Mask: 0001h	
50145	int16	4183	Alarms Digital Inputs 2 active (reserved)			
			Internal		Mask: 8000h	
			Internal		Mask: 4000h	
			Internal		Mask: 2000h	
			Internal		Mask: 1000h	
			Internal		Mask: 0800h	
			Internal		Mask: 0400h	
			Internal		Mask: 0200h	
			Internal		Mask: 0100h	
			Internal		Mask: 0080h	
			Internal		Mask: 0040h	
			Internal		Mask: 0020h	
			Internal		Mask: 0010h	
			Internal		Mask: 0008h	
			Internal		Mask: 0004h	
			Internal		Mask: 0002h	

Modbus-Address	Size	Index	Description	Unit	Scale	Model
			Internal		Mask: 0001h	
50146	int16		Internal			
50147	int16		Internal			
50148	int16		Internal			
50149	int16		Internal			
Subtopic Flexible Thresholds						
50150	int16	10279	BITLIST Alarms Flex.Thresholds 1-16 latched			
			15.16 Flexible limit 16 latched		Mask: 8000h	All
			15.15 Flexible limit 15 latched		Mask: 4000h	All
			15.14 Flexible limit 14 latched		Mask: 2000h	All
			15.13 Flexible limit 13 latched		Mask: 1000h	All
			15.12 Flexible limit 12 latched		Mask: 0800h	All
			15.11 Flexible limit 11 latched		Mask: 0400h	All
			15.10 Flexible limit 10 latched		Mask: 0200h	All
			15.09 Flexible limit 9 latched		Mask: 0100h	All
			15.08 Flexible limit 8 latched		Mask: 0080h	All
			15.07 Flexible limit 7 latched		Mask: 0040h	All
			15.06 Flexible limit 6 latched		Mask: 0020h	All
			15.05 Flexible limit 5 latched		Mask: 0010h	All
			15.04 Flexible limit 4 latched		Mask: 0008h	All
			15.03 Flexible limit 3 latched		Mask: 0004h	All
			15.02 Flexible limit 2 latched		Mask: 0002h	All
			15.01 Flexible limit 1 latched		Mask: 0001h	All
50151	int16	4175	Alarms Flexible thresholds 1-16 active (reserved)			
			Internal		Mask: 8000h	
			Internal		Mask: 4000h	
			Internal		Mask: 2000h	
			Internal		Mask: 1000h	
			Internal		Mask: 0800h	
			Internal		Mask: 0400h	
			Internal		Mask: 0200h	
			Internal		Mask: 0100h	
			Internal		Mask: 0080h	
			Internal		Mask: 0040h	
			Internal		Mask: 0020h	
			Internal		Mask: 0010h	
			Internal		Mask: 0008h	

Modbus-Address	Size	Index	Description	Unit	Scale	Model
			Internal		Mask: 0004h	
			Internal		Mask: 0002h	
			Internal		Mask: 0001h	
50152	int16	10280	BITLIST Alarms Flex.Thresholds 17-32 latched			
			15.32 Flexible limit 32 latched		Mask: 8000h	All
			15.31 Flexible limit 31 latched		Mask: 4000h	All
			15.30 Flexible limit 30 latched		Mask: 2000h	All
			15.29 Flexible limit 29 latched		Mask: 1000h	All
			15.28 Flexible limit 28 latched		Mask: 0800h	All
			15.27 Flexible limit 27 latched		Mask: 0400h	All
			15.26 Flexible limit 26 latched		Mask: 0200h	All
			15.25 Flexible limit 25 latched		Mask: 0100h	All
			15.24 Flexible limit 24 latched		Mask: 0080h	All
			15.23 Flexible limit 23 latched		Mask: 0040h	All
			15.22 Flexible limit 22 latched		Mask: 0020h	All
			15.21 Flexible limit 21 latched		Mask: 0010h	All
			15.20 Flexible limit 20 latched		Mask: 0008h	All
			15.19 Flexible limit 19 latched		Mask: 0004h	All
			15.18 Flexible limit 18 latched		Mask: 0002h	All
			15.17 Flexible limit 17 latched		Mask: 0001h	All
50153	int16	4177	Alarms Flexible thresholds 17-32 active (reserved)			
			Internal		Mask: 8000h	
			Internal		Mask: 4000h	
			Internal		Mask: 2000h	
			Internal		Mask: 1000h	
			Internal		Mask: 0800h	
			Internal		Mask: 0400h	
			Internal		Mask: 0200h	
			Internal		Mask: 0100h	
			Internal		Mask: 0080h	
			Internal		Mask: 0040h	
			Internal		Mask: 0020h	
			Internal		Mask: 0010h	
			Internal		Mask: 0008h	
			Internal		Mask: 0004h	
			Internal		Mask: 0002h	
			Internal		Mask: 0001h	

9 Appendix

9.2.4 Protocol 5010 (Basic Visualization)

Modbus-Address	Size	Index	Description	Unit	Scale	Model
50154	int16	10281	BITLIST Alarms Flex.Thresholds 33-40 latched			
			Internal		Mask: 8000h	
			Internal		Mask: 4000h	
			Internal		Mask: 2000h	
			Internal		Mask: 1000h	
			Internal		Mask: 0800h	
			Internal		Mask: 0400h	
			Internal		Mask: 0200h	
			Internal		Mask: 0100h	
			15.40 Flexible limit 40 latched		Mask: 0080h	All
			15.39 Flexible limit 39 latched		Mask: 0040h	All
			15.38 Flexible limit 38 latched		Mask: 0020h	All
			15.37 Flexible limit 37 latched		Mask: 0010h	All
			15.36 Flexible limit 36 latched		Mask: 0008h	All
			15.35 Flexible limit 35 latched		Mask: 0004h	All
			15.34 Flexible limit 34 latched		Mask: 0002h	All
			15.33 Flexible limit 33 latched		Mask: 0001h	All
50155	int16	4179	Alarms Flexible thresholds 33-40 active (reserved)			
			Internal		Mask: 8000h	
			Internal		Mask: 4000h	
			Internal		Mask: 2000h	
			Internal		Mask: 1000h	
			Internal		Mask: 0800h	
			Internal		Mask: 0400h	
			Internal		Mask: 0200h	
			Internal		Mask: 0100h	
			Internal		Mask: 0080h	
			Internal		Mask: 0040h	
			Internal		Mask: 0020h	
			Internal		Mask: 0010h	
			Internal		Mask: 0008h	
			Internal		Mask: 0004h	
			Internal		Mask: 0002h	
			Internal		Mask: 0001h	
50156	int16		Internal			
50157	int16		Internal			
50158	int16		Internal			

Modbus-Address	Size	Index	Description	Unit	Scale	Model
Subtopic DC Analogue Values Wirebreak						
50159	int16	10137	BITLIST Alarms AI Wire Break latched			
			Internal		Mask: 0001h	
			10.01 Analog input 1 wire break		Mask: 0002h	All
			10.02 Analog input 2 wire break		Mask: 0004h	All
			10.03 Analog input 3 wire break		Mask: 0008h	All
			10.04 Analog input 4 wire break		Mask: 0010h	EG3500XT-P2
			10.05 Analog input 5 wire break		Mask: 0020h	EG3500XT-P2
			10.06 Analog input 6 wire break		Mask: 0040h	EG3500XT-P2
			10.07 Analog input 7 wire break		Mask: 0080h	EG3500XT-P2
			10.08 Analog input 8 wire break		Mask: 0100h	EG3500XT-P2
			10.09 Analog input 9 wire break		Mask: 0200h	EG3500XT-P2
			10.10 Analog input 10 wire break		Mask: 0400h	EG3500XT-P2
			Internal		Mask: 0800h	
			Internal		Mask: 1000h	
			Internal		Mask: 2000h	
			Internal		Mask: 4000h	
			Internal		Mask: 8000h	
50160	int16	4173	Alarms Analog Inputs Wire Break active (reserved)			
			Internal		Mask: 0001h	
			Internal		Mask: 0002h	
			Internal		Mask: 0004h	
			Internal		Mask: 0008h	
			Internal		Mask: 0010h	
			Internal		Mask: 0020h	
			Internal		Mask: 0040h	
			Internal		Mask: 0080h	
			Internal		Mask: 0100h	
			Internal		Mask: 0200h	
			Internal		Mask: 0400h	
			Internal		Mask: 0800h	
			Internal		Mask: 1000h	
			Internal		Mask: 2000h	
			Internal		Mask: 4000h	
			Internal		Mask: 8000h	
50161	int16	10285	BITLIST Alarms Ext.AI Wire Break latched			
			25.01 Ext. analog input 1 wire break		Mask: 0001h	All

Modbus-Address	Size	Index	Description	Unit	Scale	Model
			25.02 Ext. analog input 2 wire break		Mask: 0002h	All
			25.03 Ext. analog input 3 wire break		Mask: 0004h	All
			25.04 Ext. analog input 4 wire break		Mask: 0008h	All
			25.05 Ext. analog input 5 wire break		Mask: 0010h	All
			25.06 Ext. analog input 6 wire break		Mask: 0020h	All
			25.07 Ext. analog input 7 wire break		Mask: 0040h	All
			25.08 Ext. analog input 8 wire break		Mask: 0080h	All
			25.09 Ext. analog input 9 wire break		Mask: 0100h	All
			25.10 Ext. analog input 10 wire break		Mask: 0200h	All
			25.11 Ext. analog input 11 wire break		Mask: 0400h	All
			25.12 Ext. analog input 12 wire break		Mask: 0800h	All
			25.13 Ext. analog input 13 wire break		Mask: 1000h	All
			25.14 Ext. analog input 14 wire break		Mask: 2000h	All
			25.15 Ext. analog input 15 wire break		Mask: 4000h	All
			25.16 Ext. analog input 16 wire break		Mask: 8000h	All
50162	int16	4196	Alarms External Analog Inputs Wire Break active (reserved)			
			Internal		Mask: 0001h	
			Internal		Mask: 0002h	
			Internal		Mask: 0004h	
			Internal		Mask: 0008h	
			Internal		Mask: 0010h	
			Internal		Mask: 0020h	
			Internal		Mask: 0040h	
			Internal		Mask: 0080h	
			Internal		Mask: 0100h	
			Internal		Mask: 0200h	
			Internal		Mask: 0400h	
			Internal		Mask: 0800h	
			Internal		Mask: 1000h	
			Internal		Mask: 2000h	
			Internal		Mask: 4000h	
			Internal		Mask: 8000h	
50163	int16		Internal			
50164	int16		Internal			
Subtopic GAP Alarms						
50165	int16	10286	BITLIST Other Alarms 1 latched (unacknowledged)			

Modbus-Address	Size	Index	Description	Unit	Scale	Model
			08.53 LS interface redundancy latched		Mask: 8000h	EG3500XT-P1 EG3500XT-P2
			Internal		Mask: 4000h	
			Free alarm 4		Mask: 2000h	All
			Free alarm 3		Mask: 1000h	All
			Free alarm 2		Mask: 0800h	All
			Free alarm 1		Mask: 0400h	All
			05.21 Max. starts per time		Mask: 0200h	K36
			17.09 Neutral interl. reply mismatch latched		Mask: 0100h	All
			17.08 Decoupling GCB-MCB latched		Mask: 0080h	All
			17.07 Measurement difference 4105 latched		Mask: 0040h	All
			17.06 Parameter alignment 4105 latched		Mask: 0020h	All
			17.05 Missing member 4105 latched		Mask: 0010h	All
			08.22 Busbar v/f not ok latched		Mask: 0008h	All
			08.21 Feedback GCB mismatch latched		Mask: 0004h	MARINE
			17.02 Reactive load share mismatch latched		Mask: 0002h	All
			17.01 Active load share mismatch latched		Mask: 0001h	All
50166	int16	5197	Alarms GAP active (reserved)			
			Internal		Mask: 8000h	
			Internal		Mask: 4000h	
			Internal		Mask: 2000h	
			Internal		Mask: 1000h	
			Internal		Mask: 0800h	
			Internal		Mask: 0400h	
			Internal		Mask: 0200h	
			Internal		Mask: 0100h	
			Internal		Mask: 0080h	
			Internal		Mask: 0040h	
			Internal		Mask: 0020h	
			Internal		Mask: 0010h	
			Internal		Mask: 0008h	
			Internal		Mask: 0004h	
			Internal		Mask: 0002h	
			Internal		Mask: 0001h	
50167	int16		Internal			
50168	int16		Internal			
50169	int16		Internal			

Modbus-Address	Size	Index	Description	Unit	Scale	Model
50170	int16		Internal			
Topic Engine Management						
Subtopic Active Diagnostic Trouble Code (DM1) 1-10 (SPN Range 0...65535)full SPN value at 450425-450444						
1. Active Diagnostic Trouble Code (DM1)						
50171	int16	15400	SPN of 1. entry		low 16 bits of 19 bits of SPN	All
50172	uint16		BITLIST			
		15401	FMI		Mask FF00h	All
		15402	OC		Mask 00FFh	All
2. Active Diagnostic Trouble Code (DM1)						
50173	int16	15403	SPN of 2. entry		low 16 bits of 19 bits of SPN	All
50174	uint16		BITLIST			
		15404	FMI		Mask FF00h	All
		15405	OC		Mask 00FFh	All
3. Active Diagnostic Trouble Code (DM1)						
50175	int16	15406	SPN of 3. entry		low 16 bits of 19 bits of SPN	All
50176	uint16		BITLIST			
		15407	FMI		Mask FF00h	All
		15408	OC		Mask 00FFh	All
4. Active Diagnostic Trouble Code (DM1)						
50177	int16	15409	SPN of 4. entry		low 16 bits of 19 bits of SPN	All
50178	uint16		BITLIST			
		15410	FMI		Mask FF00h	All
		15411	OC		Mask 00FFh	All
5. Active Diagnostic Trouble Code (DM1)						
50179	int16	15412	SPN of 5. entry		low 16 bits of 19 bits of SPN	All
50180	uint16		BITLIST			
		15413	FMI		Mask FF00h	All
		15414	OC		Mask 00FFh	All
6. Active Diagnostic Trouble Code (DM1)						
50181	int16	15415	SPN of 6. entry		low 16 bits of 19 bits of SPN	All
50182	uint16		BITLIST			
		15416	FMI		Mask FF00h	All
		15418	OC		Mask 00FFh	All
7. Active Diagnostic Trouble Code (DM1)						

Modbus-Address	Size	Index	Description	Unit	Scale	Model
50183	int16	15419	SPN of 7. entry		low 16 bits of 19 bits of SPN	All
50184	uint16	15420	BITLIST			
			FMI		Mask FF00h	All
		15421	OC		Mask 00FFh	All
8. Active Diagnostic Trouble Code (DM1)						
50185	int16	15422	SPN of 8. entry		low 16 bits of 19 bits of SPN	All
50186	uint16	15423	BITLIST			
			FMI		Mask FF00h	All
		15424	OC		Mask 00FFh	All
9. Active Diagnostic Trouble Code (DM1)						
50187	int16	15425	SPN of 9. entry		low 16 bits of 19 bits of SPN	All
50188	uint16		BITLIST			
		15426	FMI		Mask FF00h	All
		15427	OC		Mask 00FFh	All
10. Active Diagnostic Trouble Code (DM1)						
50189	int16	15428	SPN of 10. entry		low 16 bits of 19 bits of SPN	All
50190	uint16		BITLIST			
		15429	FMI		Mask FF00h	All
		15430	OC		Mask 00FFh	All
Subtopic DM1 Lamp Status						
50191	int16	15395	BITLIST J1939 Lamp Status DM1			
			Internal		Mask 8000h	
			Internal		Mask 4000h	
			On Malfunction Lamp		Mask 2000h	All
			Off Malfunction Lamp		Mask 1000h	All
			Internal		Mask 0800h	
			Internal		Mask 0400h	
			On Red Stop Lamp		Mask 0200h	All
			Off Red Stop Lamp		Mask 0100h	All
			Internal		Mask 0080h	
			Internal		Mask 0040h	
			On Amber Warning Lamp		Mask 0020h	All
			Off Amber Warning Lamp		Mask 0010h	All
			Internal		Mask 0008h	
			Internal		Mask 0004h	

Modbus-Address	Size	Index	Description	Unit	Scale	Model
			On Protect Lamp		Mask 0002h	All
			Off Protect Lamp		Mask 0001h	All
Subtopic DM2 Lamp Status						
50192	int16	15445	BITLIST J1939 Lamp Status DM2			
			Internal		Mask 8000h	
			Internal		Mask 4000h	
			On Malfunction Lamp		Mask 2000h	All
			Off Malfunction Lamp		Mask 1000h	All
			Internal		Mask 0800h	
			Internal		Mask 0400h	
			On Red Stop Lamp		Mask 0200h	All
			Off Red Stop Lamp		Mask 0100h	All
			Internal		Mask 0080h	
			Internal		Mask 0040h	
			On Amber Warning Lamp		Mask 0020h	All
			Off Amber Warning Lamp		Mask 0010h	All
			Internal		Mask 0008h	
			Internal		Mask 0004h	
			On Protect Lamp		Mask 0002h	All
			Off Protect Lamp		Mask 0001h	All
Subtopic Especially Failure Codes						
50193	int16	15109	J1939 MTU ADEC ECU Failure Codes		*1	All
50194	int16		Internal			
50195	uint16	15304	J1939 EMR Engine Stop Information (refer to DEUTZ-specific J1939-Message) "Missing" Value="65535" "Error" Value="65279" "Type 9" Value="9" "Type 8" Value="8" "Type 7" Value="7" "Type 6" Value="6" "Type 5" Value="5" "Type 4" Value="4" "Type 3" Value="3" "Type 2" Value="2" "Type 1" Value="1" "Type 0" Value="0"			All

Modbus-Address	Size	Index	Description	Unit	Scale	Model
50196	int16		Internal			
50197	int16	15305	BITLIST J1939 DLN2-Message Scania S6			
			Engine Coolant Temperature			
			J1939-Message not available		Mask 8000h	All
			Sensor fault		Mask 4000h	All
			High Temperature.		Mask 2000h	All
			NOT High Temperature		Mask 1000h	All
			Engine Oil Pressure			
			J1939-Message not available		Mask 0800h	All
			Sensor fault		Mask 0400h	All
			Low Pressure		Mask 0200h	All
			NOT Low Pressure		Mask 0100h	All
			High Engine Oil Level			
			J1939-Message not available		Mask 0080h	All
			Sensor fault		Mask 0040h	All
			High Level		Mask 0020h	All
			NOT High Level		Mask 0010h	All
			Low Engine Oil Level			
			J1939-Message not available		Mask 0008h	All
			Sensor fault		Mask 0004h	All
			Low Level		Mask 0002h	All
			NOT Low Level		Mask 0001h	All
50198	int16		Internal			
50199	int16		Internal			
50200	int16		Internal			
Subtopic Values						
50201	int16	15308	Engine Speed (SPN 190)	rpm	*1	All
50202	int16	15202	Engine Coolant Temperature (SPN 110)	°C	*1	All
50203	int16	15203	Fuel temperature (SPN 174)	°C	*1	All
50204	int16	15309	Engine Oil Temperature 1 (SPN 175)	°C	*10	All
50205	int16	15205	Engine Oil Pressure (SPN 100)	kPa	*1	All
50206	int16	15307	Fuel Rate (SPN 183)	L/h	*10	All
50207	int16	15206	Coolant Level (SPN 111)	%	*10	All
50208	int16	15207	Throttle position (SPN 91)	%	*10	All
50209	int16	15208	Load at current Speed (SPN 92)	%	*1	All
50210	int16	15210	Engine oil level (SPN 98)	%	*10	All
50211	int16	15214	Boost pressure (SPN 102)	kPa	*1	All

9 Appendix

9.2.4 Protocol 5010 (Basic Visualization)

Modbus-Address	Size	Index	Description	Unit	Scale	Model
50212	int16	15215	Intake Manifold 1 Temp (SPN 105)	°C	*1	All
50213	int16	15212	Barometric Pressure (SPN 108)	kPa	*10	All
50214	int16	15213	Air inlet temperature (SPN 172)	°C	*1	All
50215	int16	15209	Actual engine torque (SPN 513)	%	*1	All
50216	int16	15299	Exhaust Gas Temp.(SPN 173)	°C	*10	All
50217	int16	15217	Engine Intercooler Temp (SPN52)	°C	*1	All
50218	int16	15218	Fuel Delivery Pressure (SPN94)	kPa	*1	All
50219	int16	15219	Fuel Filter Differential Pressure (SPN95)	kPa	*1	All
50220	int16	15220	Crankcase Pressure (SPN101)	kPa	*1	All
50221	int16	15221	Turbo Air Inlet Pressure (SPN106)	kPa	*1	All
50222	int16	15222	Air Filter 1 Differential Pressure (SPN107)	kPa	*100	All
50223	int16	15223	Coolant Pressure (SPN109)	kPa	*1	All
50224	int16	15224	Transmission Oil Pressure (SPN127)	kPa	*1	All
50225	int16	15225	Fuel Rail Pressure (SPN157)	MPa	*10	All
50226	int16	15226	Ambient Air Temperature (SPN171)	°C	*10	All
50227	int16	15227	Turbo Oil Temperature (SPN176)	°C	*10	All
50228	int16	15228	Transmission Oil Temperature (SPN177)	°C	*10	All
50229	int16	15229	Auxiliary Temperature 1 (SPN441)	°C	*1	All
50230	int16	15230	Auxiliary Temperature 2 (SPN442)	°C	*1	All
50231	int16	15209	Actual engine torque (SPN 513)	%	*1	All
50232	int16	15231	Alternator Bear. 1 Temperature (SPN1122)	°C	*1	All
50233	int16	15232	Alternator Bear. 2 Temperature (SPN1123)	°C	*1	All
50234	int16	15233	Alternator Wind. 1 Temperature (SPN1124)	°C	*1	All
50235	int16	15234	Alternator Wind. 2 Temperature (SPN1125)	°C	*1	All
50236	int16	15235	Alternator Wind. 3 Temperature (SPN1126)	°C	*1	All
50237	int16	15236	Intake Manifold 2 Temperature (SPN1131)	°C	*1	All
50238	int16	15237	Intake Manifold 3 Temperature (SPN1132)	°C	*1	All
50239	int16	15238	Intake Manifold 4 Temperature (SPN1133)	°C	*1	All
50240	int16	15239	Engine Intercooler Thermostat Opening (SPN1134)	%	*10	All
50241	int16	15240	Engine Oil Temperature 2 (SPN1135)	°C	*10	All
50242	int16	15241	Engine ECU Temperature (SPN1136)	°C	*10	All
50243	int16	15242	Exhaust Gas Port 1 Temperatures (SPN1137)	°C	*10	All
50244	int16	15243	Exhaust Gas Port 2 Temperatures (SPN1138)	°C	*10	All
50245	int16	15244	Exhaust Gas Port 3 Temperatures (SPN1139)	°C	*10	All
50246	int16	15245	Exhaust Gas Port 4 Temperatures (SPN1140)	°C	*10	All
50247	int16	15246	Exhaust Gas Port 5 Temperatures (SPN1141)	°C	*10	All
50248	int16	15247	Exhaust Gas Port 6 Temperatures (SPN1142)	°C	*10	All

Modbus-Address	Size	Index	Description	Unit	Scale	Model
50249	int16	15248	Exhaust Gas Port 7 Temperatures (SPN1143)	°C	*10	All
50250	int16	15249	Exhaust Gas Port 8 Temperatures (SPN1144)	°C	*10	All
50251	int16	15250	Exhaust Gas Port 9 Temperatures (SPN1145)	°C	*10	All
50252	int16	15251	Exhaust Gas Port 10 Temperatures (SPN1146)	°C	*10	All
50253	int16	15252	Exhaust Gas Port 11 Temperatures (SPN1147)	°C	*10	All
50254	int16	15253	Exhaust Gas Port 12 Temperatures (SPN1148)	°C	*10	All
50255	int16	15254	Exhaust Gas Port 13 Temperatures (SPN1149)	°C	*10	All
50256	int16	15255	Exhaust Gas Port 14 Temperatures (SPN1150)	°C	*10	All
50257	int16	15256	Exhaust Gas Port 15 Temperatures (SPN1151)	°C	*10	All
50258	int16	15257	Exhaust Gas Port 16 Temperatures (SPN1152)	°C	*10	All
50259	int16	15258	Exhaust Gas Port 17 Temperatures (SPN1153)	°C	*10	All
50260	int16	15259	Exhaust Gas Port 18 Temperatures (SPN1154)	°C	*10	All
50261	int16	15260	Exhaust Gas Port 19 Temperatures (SPN1155)	°C	*10	All
50262	int16	15261	Exhaust Gas Port 20 Temperatures (SPN1156)	°C	*10	All
50263	int16	15262	Main Bearing 1 Temperatures (SPN1157)	°C	*10	All
50264	int16	15263	Main Bearing 2 Temperatures (SPN1158)	°C	*10	All
50265	int16	15264	Main Bearing 3 Temperatures (SPN1159)	°C	*10	All
50266	int16	15265	Main Bearing 4 Temperatures (SPN1160)	°C	*10	All
50267	int16	15266	Main Bearing 5 Temperatures (SPN1161)	°C	*10	All
50268	int16	15267	Main Bearing 6 Temperatures (SPN1162)	°C	*10	All
50269	int16	15268	Main Bearing 7 Temperatures (SPN1163)	°C	*10	All
50270	int16	15269	Main Bearing 8 Temperatures (SPN1164)	°C	*10	All
50271	int16	15270	Main Bearing 9 Temperatures (SPN1165)	°C	*10	All
50272	int16	15271	Main Bearing 10 Temperatures (SPN1166)	°C	*10	All
50273	int16	15272	Main Bearing 11 Temperatures (SPN1167)	°C	*10	All
50274	int16	15273	Turbo 1 Compressor Inlet Temperatures (SPN1172)	°C	*10	All
50275	int16	15274	Turbo 2 Compressor Inlet Temperatures (SPN1173)	°C	*10	All
50276	int16	15275	Turbo 3 Compressor Inlet Temperatures (SPN1174)	°C	*10	All
50277	int16	15276	Turbo 4 Compressor Inlet Temperatures (SPN1175)	°C	*10	All
50278	int16	15277	Turbo 1 Compressor Inlet Pressure (SPN1176)	kPa	*1	All
50279	int16	15278	Turbo 2 Compressor Inlet Pressure (SPN1177)	kPa	*1	All
50280	int16	15279	Turbo 3 Compressor Inlet Pressure (SPN1178)	kPa	*1	All
50281	int16	15280	Turbo 4 Compressor Inlet Pressure (SPN1179)	kPa	*1	All
50282	int16	15281	Turbo 1 Turbine Inlet Temperature (SPN1180)	°C	*10	All
50283	int16	15282	Turbo 2 Turbine Inlet Temperature (SPN 1181)	°C	*10	All

Modbus-Address	Size	Index	Description	Unit	Scale	Model
50284	int16	15283	Turbo 3 Turbine Inlet Temperature (SPN 1182)	°C	*10	All
50285	int16	15284	Turbo 4 Turbine Inlet Temperature (SPN1183)	°C	*10	All
50286	int16	15285	Turbo 1 Turbine Outlet Temperature (SPN1184)	°C	*10	All
50287	int16	15286	Turbo 2 Turbine Outlet Temperature (SPN1185)	°C	*10	All
50288	int16	15287	Turbo 3 Turbine Outlet Temperature (SPN 1186)	°C	*10	All
50289	int16	15288	Turbo 4 Turbine Outlet Temperature (SPN1187)	°C	*10	All
50290	int16	15289	Engine Aux. Coolant Pressure (SPN1203)	kPa	*1	All
50291	int16	15290	Pre-filter Oil Pressure (SPN1208)	kPa	*1	All
50292	int16	15291	Engine Aux. Coolant Temperature (SPN1212)	°C	*1	All
50293	int16	15292	Fuel Filter Differential Pressure (SPN1382)	kPa	*1	All
50294	int16	15293	Battery 1 Temperature (SPN1800)	°C	*1	All
50295	int16	15294	Battery 2 Temperature (SPN1801)	°C	*1	All
50296	int16	15295	Intake Manifold 5 Temperature (SPN1802)	°C	*1	All
50297	int16	15296	Intake Manifold 6 Temperature (SPN1803)	°C	*1	All
50298	int16	15297	Right Exhaust Gas Temperature (SPN2433)	°C	*10	All
50299	int16	15298	Left Exhaust Gas Temperature (SPN2434)	°C	*10	All
50300	int16	15310	Turbo 1 Compr. Outlet Temperature (SPN2629)	°C	*10	All
50301	int16	15311	Engine derate request (SPN3644)	%	*10	All
50302	int16	15312	Batterie Potential (SPN0158)	V	*10	All
50303	int16	15313	Aftertreatment 1 Diesel Exhaust Fluid Tank 1 Level (SPN1761)	%	*10	All
50304	int16	15314	Aftertreatment 1 Diesel Exhaust Fluid Tank 1 Temperature (SPN3031)	°C	*1	All
50305	int16	15315	Aftertreatment 1 Diesel Exhaust Fluid Tank 2 Level (SPN4367)	%	*10	All
50306	int16	15316	Aftertreatment 1 Diesel Exhaust Fluid Tank 2 Temperature (SPN4368)	°C	*1	All
50307	int16	12807	Exhaust Gas Temperature Average(SPN 4151)	°C	*10	All
50308	int16	12809	Exhaust Gas Temperature Average Bank 1 (SPN 4153)	°C	*10	All
50309	int16	12812	Exhaust Gas Temperature Average Bank 2 (SPN 4152)	°C	*10	All
50310	int16		Internal			
50311	int16		Internal			
50312	int16		Internal			
50313	int16		Internal			
50314	int16		Internal			
50315	int16		Internal			
50316	int16		Internal			
50317	int16		Internal			

Modbus-Address	Size	Index	Description	Unit	Scale	Model
50318	int16		Internal			
50319	int16		Internal			
50320	int16		Internal			
50321	int16		Internal			
Int32 (Long)						
Topic AC Generator and Busbar values						
50322	int32	135	Total gen. power	W	*1	All
50324	int32	136	Total gen. reactive power	var	*1	All
50326	int32	137	Total gen. apparent power	VA	*1	All
50328	int32	170	Av. Gen. Wye-Voltage	V	*10	All
50330	int32	171	Av. Gen. Delta-Voltage	V	*10	All
50332	int32	216	Av. Busbar 1 Delta-Voltage	V	*10	All
50334	int32	185	Av. Gen. Current	A	*1000	All
50336	int32	111	Gen. current 1	A	*1000	All
50338	int32	112	Gen. current 2	A	*1000	All
50340	int32	113	Gen. current 3	A	*1000	All
50342	int32	161	Meas. ground current	A	*1000	All
50344	int32	159	Calculated ground current	A	*1000	All
50346	int32	108	Gen. voltage L1-L2	V	*10	All
50348	int32	109	Gen. voltage L2-L3	V	*10	All
50350	int32	110	Gen. voltage L3-L1	V	*10	All
50352	int32	114	Gen. voltage L1-N	V	*10	All
50354	int32	115	Gen. voltage L2-N	V	*10	All
50356	int32	116	Gen. voltage L3-N	V	*10	All
50358	int32	125	Gen. active power 1-N	W	*1	All
50360	int32	126	Gen. active power 2-N	W	*1	All
50362	int32	127	Gen. active power 3-N	W	*1	All
50364	int32	182	Busbar 1: voltage L1-L2	V	*10	All
50366	int32	2520	Gen. real energy	MWh	*100	All
50368	int32	2522	Gen. positive reactive energy	Mvarh	*100	All
50370	int32	2568	Gen. hours of operation	h	*100	All
50372	int32	5542	Setpoint active power	kW	*10	All
50374	int32	5640	Setpoint voltage	V	*1	All
50376	int32	234	Average Busbar Wye-Voltage	V	*10	All
50378	int32	189	Busbar 1: voltage L2-L3	V	*10	EG3500XT-P1 EG3500XT-P2
50380	int32	193	Busbar 1: voltage L3-L1	V	*10	EG3500XT-P1

Modbus-Address	Size	Index	Description	Unit	Scale	Model
						EG3500XT-P2
50382	int32		Internal			
Topic AC Mains values						
50384	int32	140	Total mains power	W	*1	All
50386	int32	150	Total mains reactive power	var	*1	All
50388	int32	173	Av. Mains Wye-Voltage	V	*10	All
50390	int32	174	Av. Mains Delta-Voltage	V	*10	All
50392	int32	207	Av. Mains Current	A	*1000	All
50394	int32	134	Mains current L1	A	*1000	All
50396	int32		Internal			
50398	int32		Internal			
50400	int32	118	Mains voltage L1-L2	V	*10	All
50402	int32	119	Mains voltage L2-L3	V	*10	All
50404	int32	120	Mains voltage L3-L1	V	*10	All
50406	int32	121	Mains voltage L1-N	V	*10	All
50408	int32	122	Mains voltage L2-N	V	*10	All
50410	int32	123	Mains voltage L3-N	V	*10	All
Topic AC System values						
50412	int32	217	Reserve real power in system (valid if LDSS is on)	kW	*1	All
50414	int32	218	Real power in system (vaild if LDSS is on)	kW	*1	All
50416	int32	219	Nominal real power in system (vaild if LDSS is on)	kW	*1	All
50418	int32		Internal			
50420	int32		Internal			
50422	int32		Internal			
Topic Engine Management						
Subtopic Active Diagnostic Trouble Code (DM1) 1-10 (All SPNs)						
50424	int32	15400	SPN of 1. entry		full 19 bits of SPN	All
50426	int32	15403	SPN of 2. entry		full 19 bits of SPN	All
50428	int32	15406	SPN of 3. entry		full 19 bits of SPN	All
50430	int32	15409	SPN of 4. entry		full 19 bits of SPN	All
50432	int32	15412	SPN of 5. entry		full 19 bits of SPN	All
50434	int32	15415	SPN of 6. entry		full 19 bits of SPN	All
50436	int32	15419	SPN of 7. entry		full 19 bits of SPN	All

Modbus-Address	Size	Index	Description	Unit	Scale	Model
50438	int32	15422	SPN of 8. entry		full 19 bits of SPN	All
50440	int32	15425	SPN of 9. entry		full 19 bits of SPN	All
50442	int32	15428	SPN of 10. entry		full 19 bits of SPN	All
Subtopic Values						
50444	uint32	15201	Total engine hours (j1939-HOURS)	h	*1	All
50446	uint32	2580	Period of use counter			EG3500XT-P1 EG3500XT-P2
50448	int32		Internal			
50450	int32		Internal			
50452	int32		Internal			
Topic LSx						
50454	int32	267	Average LSx Delta Mains voltage L-L	V	*10	EG3500XT-P1 EG3500XT-P2
50456	int32	268	Average LSx Wye Mains voltage L-N	V	*10	EG3500XT-P1 EG3500XT-P2
50458	int32	269	Active power LSx (Active mains power in own segment)	W	*1	EG3500XT-P1 EG3500XT-P2
50460	int32	270	Reactive power LSx (Reactive mains power in own segment)	var	*1	EG3500XT-P1 EG3500XT-P2

9.2.5 Protocol 5011 (Alarm Values Visualization)

CAN Mux	CAN Byte	Size	Index	Description	Unit	Scale	Model
0	1-2	uint16		Protocol-ID, always 5011			
Subtopic Generator							
0	3-4	uint16	4161	BITLIST Alarms Generator active			
				Gen.overfreq. 1		Mask: 8000h	All
				Gen.overfreq. 2		Mask: 4000h	All
				Gen.underfreq. 1		Mask: 2000h	All
				Gen.underfreq. 2		Mask: 1000h	All
				Gen.overnvolt. 1		Mask: 0800h	All
				Gen.overnvolt. 2		Mask: 0400h	All
				Gen.undervolt. 1		Mask: 0200h	All
				Gen.undervolt. 2		Mask: 0100h	All

CAN Mux	CAN Byte	Size	Index	Description	Unit	Scale	Model
				Gen. overcurr. 1		Mask: 0080h	All
				Gen. overcurr. 2		Mask: 0040h	All
				Gen. overcurr. 3		Mask: 0020h	All
				Gen. Rv/Rd pow.1		Mask: 0010h	All
				Gen. Rv/Rd pow.2		Mask: 0008h	All
				Gen. Overload IOP 1		Mask: 0004h	All
				Gen. Overload IOP 2		Mask: 0002h	All
				Busbar phase rotation mismatch		Mask: 0001h	EG3500XT-P2
0	5-6	uint16	10134	BITLIST Alarms Generator latched (unacknowledged)			
				06.01 Generator over frequency 1 latched		Mask: 8000h	All
				06.02 Generator over frequency 2 latched		Mask: 4000h	All
				06.03 Generator under frequency 1 latched		Mask: 2000h	All
				06.04 Generator under frequency 2 latched		Mask: 1000h	All
				06.05 Generator over voltage 1 latched		Mask: 0800h	All
				06.06 Generator over voltage 2 latched		Mask: 0400h	All
				06.07 Generator under voltage 1 latched		Mask: 0200h	All
				06.08 Generator under voltage 2 latched		Mask: 0100h	All
				06.09 Generator over current 1 latched		Mask: 0080h	All
				06.10 Generator over current 2 latched		Mask: 0040h	All
				06.11 Generator over current 3 latched		Mask: 0020h	All
				06.12 Reverse / reduced power 1 latched		Mask: 0010h	All
				06.13 Reverse / reduced power 2 latched		Mask: 0008h	All
				06.14 Generator overload IOP 1 latched		Mask: 0004h	All
				06.15 Generator overload IOP 2 latched		Mask: 0002h	All
				06.34 Busbar phase rotation mismatch		Mask: 0001h	EG3500XT-P2
1	1-2	uint16	4163	BITLIST Alarms Generator 1 active (reserved)			
				Unbal. load 1		Mask: 8000h	All
				Unbal. load 2		Mask: 4000h	All
				Gen. Asymmetry		Mask: 2000h	All
				Ground fault 1		Mask: 1000h	All
				Ground fault 2		Mask: 0800h	All
				Gen. phase rot. misw.		Mask: 0400h	All
				Gen act.pwr mismatch		Mask: 0200h	All
				Gen. unloading fault		Mask: 0100h	All
				Inv.time ov.curr.		Mask: 0080h	All
				Operating range failed,		Mask: 0040h	All
				Gen. Overload MOP 1		Mask: 0020h	All

CAN Mux	CAN Byte	Size	Index	Description	Unit	Scale	Model
				Gen. Overload MOP 2		Mask: 0010h	All
				Gen.Power Factor lagging 1		Mask: 0008h	All
				Gen.Power Factor lagging 2		Mask: 0004h	All
				Gen.Power Factor leading 1		Mask: 0002h	All
				Gen.Power Factor leading 2		Mask: 0001h	All
1	3-4	uint16	10138	BITLIST Alarms Generator 1 latched (unacknowledged)			
				06.16 Generator unbalanced load 1 latched		Mask: 8000h	All
				06.17 Generator unbalanced load 2 latched		Mask: 4000h	All
				06.18 Generator voltage asymmetry latched		Mask: 2000h	All
				06.19 Ground fault 1 latched		Mask: 1000h	All
				06.20 Ground fault 2 latched		Mask: 0800h	All
				06.21 Gen. Phase Rotation mismatch Latched		Mask: 0400h	All
				06.29 Gen. active power mismatch Latched		Mask: 0200h	All
				06.30 Generator unloading mismatch Latched		Mask: 0100h	All
				06.22 Inverse time over current Latched		Mask: 0080h	All
				06.31 Operating Range failed latched		Mask: 0040h	All
				06.23 Generator overload MOP 1 latched		Mask: 0020h	All
				06.24 Generator overload MOP 2 latched		Mask: 0010h	All
				06.25 Gen.Power Factor lagging 1 latched		Mask: 0008h	All
				06.26 Gen.Power Factor lagging 2 latched		Mask: 0004h	All
				06.27 Gen.Power Factor leading 1 latched		Mask: 0002h	All
				06.28 Gen.Power Factor leading 2 latched		Mask: 0001h	All
1	5-6	uint16	10131	BITLIST Alarm classes latched (unacknowledged)			
				01.11 New Alarm triggered		Mask: 8000h	All
				Internal		Mask: 4000h	
				Internal		Mask: 2000h	
				Internal		Mask: 1000h	
				Internal		Mask: 0800h	
				Internal		Mask: 0400h	
				Internal		Mask: 0200h	
				Internal		Mask: 0100h	
				Internal		Mask: 0080h	
				Internal		Mask: 0040h	
				01.06 Alarm class F latched		Mask: 0020h	All
				01.05 Alarm class E latched		Mask: 0010h	All
				01.04 Alarm class D latched		Mask: 0008h	All

CAN Mux	CAN Byte	Size	Index	Description	Unit	Scale	Model
				01.03 Alarm class C latched		Mask: 0004h	All
				01.02 Alarm class B latched		Mask: 0002h	All
				01.01 Alarm class A latched		Mask: 0001h	All
Subtopic Mains							
2	1-2	uint16	4188	BITLIST Alarms Mains active			
				Mains ov.freq. 1		Mask: 8000h	All
				Mains ov.freq. 2		Mask: 4000h	All
				Mains un.freq. 1		Mask: 2000h	All
				Mains un.freq. 2		Mask: 1000h	All
				Mains ov.volt. 1		Mask: 0800h	All
				Mains ov.volt. 2		Mask: 0400h	All
				Mains un.volt. 1		Mask: 0200h	All
				Mains un.volt. 2		Mask: 0100h	All
				Mains phaseshift		Mask: 0080h	All
				Mains decoupling		Mask: 0040h	All
				Mains AC Wiring		Mask: 0020h	All
				Internal		Mask: 0010h	
				Internal		Mask: 0008h	
				Mains Phase rotation mismatch		Mask: 0004h	All
				Internal		Mask: 0002h	
				Internal		Mask: 0001h	
2	3-4	uint16	10135	BITLIST Alarms Mains latched (unacknowledged)			
				07.06 Mains over frequency 1 latched		Mask: 8000h	All
				07.07 Mains over frequency 2 latched		Mask: 4000h	All
				07.08 Mains under frequency 1 latched		Mask: 2000h	All
				07.09 Mains under frequency 2 latched		Mask: 1000h	All
				07.10 Mains over voltage 1 latched		Mask: 0800h	All
				07.11 Mains over voltage 2 latched		Mask: 0400h	All
				07.12 Mains under voltage 1 latched		Mask: 0200h	All
				07.13 Mains under voltage 2 latched		Mask: 0100h	All
				07.14 Mains Phase shift latched		Mask: 0080h	All
				07.25 Mains decoupling latched		Mask: 0040h	All
				07.32 Mains AC Wiring		Mask: 0020h	All
				Internal		Mask: 0010h	
				Internal		Mask: 0008h	
				07.05 Mains Phase rotation mismatch latched		Mask: 0004h	All
				Internal		Mask: 0002h	

CAN Mux	CAN Byte	Size	Index	Description	Unit	Scale	Model
				Internal		Mask: 0001h	
2	5-6	uint16		Internal			
3	1-2	uint16	4187	BITLIST Alarms Mains 1 active			
				Mains import power 1		Mask: 8000h	All
				Mains import power 2		Mask: 4000h	All
				Mains export power 1		Mask: 2000h	All
				Mains export power 2		Mask: 1000h	All
				Mains overexcited 1		Mask: 0800h	All
				Mains overexcited 2		Mask: 0400h	All
				Mains underexcited 1		Mask: 0200h	All
				Mains underexcited 2		Mask: 0100h	All
				Mains df/dt		Mask: 0080h	All
				Mns act.pwr mismatch		Mask: 0040h	All
				Mains. Time dep. Voltage		Mask: 0020h	All
				Internal		Mask: 0010h	
				Mains slow voltage increase (10 min)		Mask: 0008h	All
				Internal		Mask: 0004h	
				Mains QV Monitoring step 1		Mask: 0002h	All
				Mains QV Monitoring step 2		Mask: 0001h	All
3	3-4	uint16	10278	BITLIST Alarms Mains 1 latched (unacknowledged)			
				07.21 Mains import power 1 latched		Mask: 8000h	All
				07.22 Mains import power 2 latched		Mask: 4000h	All
				07.23 Mains export power 1 latched		Mask: 2000h	All
				07.24 Mains export power 2 latched		Mask: 1000h	All
				07.17 Mains PF lagging 1 latched		Mask: 0800h	All
				07.18 Mains PF lagging 2 latched		Mask: 0400h	All
				07.19 Mains PF leading 1 latched		Mask: 0200h	All
				07.20 Mains PF leading 2 latched		Mask: 0100h	All
				07.15 Mains df/dt latched		Mask: 0080h	All
				07.16 Mains active power mismatch latched		Mask: 0040h	All
				07.28 Mains Time-dep. Voltage (FRT) latched		Mask: 0020h	All
				Internal		Mask: 0010h	
				07.27 Mains slow voltage increase (10 min)		Mask: 0008h	All
				Internal		Mask: 0004h	
				07.29 QU Monitoring step 1 tripped		Mask: 0002h	All
				07.30 QU Monitoring step 2 tripped		Mask: 0001h	All
3	5-6	uint16		Internal			

CAN Mux	CAN Byte	Size	Index	Description	Unit	Scale	Model
Subtopic Engine							
4	1-2	uint16	4167	BITLIST Alarms 1 active			
				Overspeed 1		Mask: 8000h	All
				Overspeed 2		Mask: 4000h	All
				Underspeed 1		Mask: 2000h	All
				Underspeed 2		Mask: 1000h	All
				Unintended stop		Mask: 0800h	All
				Speed det. Alarm		Mask: 0400h	All
				Shutdown malfunct.		Mask: 0200h	All
				GCB fail to close		Mask: 0100h	All
				GCB fail to open		Mask: 0080h	All
				MCB fail to close		Mask: 0040h	All
				MCB fail to open		Mask: 0020h	All
				CAN-Fault J1939		Mask: 0010h	All
				Start fail		Mask: 0008h	All
				Mainten. days exceeded		Mask: 0004h	All
				Mainten. hours exceeded		Mask: 0002h	All
				CANopen error at CAN Interface 1		Mask: 0001h	All
4	3-4	uint16	10133	BITLIST Alarms 1 latched (unacknowledged)			
				05.01 Engine Over speed 1 latched		Mask: 8000h	All
				05.02 Engine Over speed 2 latched		Mask: 4000h	All
				05.03 Engine under speed 1 latched		Mask: 2000h	All
				05.04 Engine under speed 2 latched		Mask: 1000h	All
				05.05 Unintended stop detected latched		Mask: 0800h	All
				05.07 Speed detection alarm latched		Mask: 0400h	All
				05.06 Shutdown malfunction detected latched		Mask: 0200h	All
				08.05 GCB fail to close latched		Mask: 0100h	All
				08.06 GCB fail to open latched		Mask: 0080h	All
				08.07 MCB fail to close latched		Mask: 0040h	All
				08.08 MCB fail to open latched		Mask: 0020h	All
				08.10 General CAN-J1939 fault latched		Mask: 0010h	All
				05.08 Start fail detected latched		Mask: 0008h	All
				05.09 Maintenance days exceeded latched		Mask: 0004h	All
				05.10 Maintenance hours exceeded latched		Mask: 0002h	All
				08.18 CANopen error at CAN Interface 1		Mask: 0001h	All
4	5-6	uint16	4193	BITLIST Alarms 3 active			
				GGB fail to close		Mask: 8000h	EG3500XT-P1

CAN Mux	CAN Byte	Size	Index	Description	Unit	Scale	Model
							EG3500XT-P2
				GGB fail to open		Mask: 4000h	EG3500XT-P1 EG3500XT-P2
				Missing easYgen		Mask: 2000h	All
				Missing LSx		Mask: 1000h	EG3500XT-P1 EG3500XT-P2
				Cylinder temperature level 1		Mask: 0800h	All
				Cylinder temperature level 2		Mask: 0400h	All
				Cylinder temperature wire break		Mask: 0200h	All
				Pole slip		Mask: 0100h	All
				Syst.update LSx		Mask: 0080h	EG3500XT-P1 EG3500XT-P2
				Syst.update easYgen		Mask: 0040h	All
				Gen.AC Wiring		Mask: 0020h	All
				Busbar1 AC Wiring		Mask: 0010h	EG3500XT-P2
				Internal		Mask: 0008h	
				Internal		Mask: 0004h	
				Internal		Mask: 0002h	
				Internal		Mask: 0001h	
5	1-2	uint16	4169	BITLIST Alarms 2 active			
				GCB sync. Timeout		Mask: 8000h	All
				MCB sync. Timeout		Mask: 4000h	All
				GGB sync. Timeout		Mask: 2000h	EG3500XT-P1 EG3500XT-P2
				Charge alt. low voltage (D+)		Mask: 1000h	All
				Phase rotation mismatch		Mask: 0800h	All
				CPU overload R1 trip		Mask: 0400h	All
				MCB failure 50BF		Mask: 0200h	All
				GCB failure 50BF		Mask: 0100h	All
				ECU Protect alarm		Mask: 0080h	All
				ECU Emission alarm		Mask: 0040h	All
				CANopen error at CAN Interface 2		Mask: 0020h	All
				Parameter Alignment		Mask: 0010h	All
				Missing easYgen		Mask: 0008h	All
				MCB plausibility		Mask: 0004h	All
				Red stop lamp DM1		Mask: 0002h	All

9 Appendix

9.2.5 Protocol 5011 (Alarm Values Visualization)

CAN Mux	CAN Byte	Size	Index	Description	Unit	Scale	Model
				Amber warning lamp DM1		Mask: 0001h	All
5	3-4	uint16	10149	BITLIST Alarms 2 latched (unacknowledged)			
				08.30 GCB syn. timeout latched		Mask: 8000h	All
				08.31 MCB syn. timeout latched		Mask: 4000h	All
				08.32 GGB Timeout latched		Mask: 2000h	EG3500XT-P1 EG3500XT-P2
				05.11 Charge alt. low voltage (D+) latched		Mask: 1000h	All
				operating range failure 12		Mask: 0800h	All
				08.45 CPU overload R1 trip		Mask: 0400h	All
				08.47 MCB failure 50BF latched		Mask: 0200h	All
				08.46 GCB failure 50BF latched		Mask: 0100h	All
				05.22 ECU Protect alarm latched		Mask: 0080h	All
				05.23 ECU Emission alarm latched		Mask: 0040h	All
				08.19 CANopen error at CAN Interface 2		Mask: 0020h	All
				08.16 Parameter Alignment latched		Mask: 0010h	All
				08.27 Missing easYgen latched		Mask: 0008h	All
				08.48 MCB plausibility latched		Mask: 0004h	All
				05.13 Red stop lamp latched		Mask: 0002h	All
				05.14 Amber warning lamp latched		Mask: 0001h	All
5	5-6	uint16	10190	BITLIST Alarms 3 latched (unacknowledged)			
				08.34 GGB fail to close latched		Mask: 8000h	EG3500XT-P1 EG3500XT-P2
				08.35 GGB fail to open latched		Mask: 4000h	EG3500XT-P1 EG3500XT-P2
				08.27 Missing easYgen		Mask: 2000h	All
				08.28 Missing LSx		Mask: 1000h	EG3500XT-P1 EG3500XT-P2
				05.18 Cylinder temperature level 1		Mask: 0800h	All
				05.19 Cylinder temperature level 2		Mask: 0400h	All
				05.20 Cylinder temperature wire break		Mask: 0200h	All
				06.35 Pole slip		Mask: 0100h	All
				08.44 Syst.update LSx		Mask: 0080h	EG3500XT-P1 EG3500XT-P2
				08.43 Syst.update easYgen		Mask: 0040h	All
				06.32 Gen.AC Wiring		Mask: 0020h	All
				06.33 Busbar1 AC Wiring		Mask: 0010h	EG3500XT-P2

CAN Mux	CAN Byte	Size	Index	Description	Unit	Scale	Model
				Internal		Mask: 0008h	
				Internal		Mask: 0004h	
				Internal		Mask: 0002h	
				Internal		Mask: 0001h	
Subtopic GAP Alarms							
6	1-2	uint16	5197	BITLIST Alarms GAP active			
				LS interf.redundancy		Mask: 8000h	EG3500XT-P1 EG3500XT-P2
				Internal		Mask: 4000h	All
				Free alarm 4		Mask: 2000h	All
				Free alarm 3		Mask: 1000h	All
				Free alarm 2		Mask: 0800h	All
				Free alarm 1		Mask: 0400h	All
				Max. starts per time		Mask: 0200h	K36
				Neutral contactor failure		Mask: 0100h	All
				Decoupling GCB<->MCB		Mask: 0080h	All
				Meas.difference 4105 VDE-AR-N 4105		Mask: 0040h	All
				Parameter alignment VDE-AR-N 4105		Mask: 0020h	All
				Missing member VDE-AR-N 4105		Mask: 0010h	All
				Busbar monitoring		Mask: 0008h	All
				Plausibility GCB feedback		Mask: 0004h	MARINE
				Reactive load sharing mismatch		Mask: 0002h	All
				Active load sharing mismatch		Mask: 0001h	All
6	3-4	uint16	10286	BITLIST Alarms GAP latched (unacknowledged)			
				08.53 LS interf.redundancy latched		Mask: 8000h	EG3500XT-P1 EG3500XT-P2
				Internal		Mask: 4000h	All
				16.04 Free alarm 4 latched		Mask: 2000h	All
				16.03 Free alarm 3 latched		Mask: 1000h	All
				16.02 Free alarm 2 latched		Mask: 0800h	All
				16.01 Free alarm 1 latched		Mask: 0400h	All
				05.21 Max. starts per time		Mask: 0200h	K36
				17.09 Neutral contactor reply mismatch latched		Mask: 0100h	All
				17.08 Decoupling GCB<->MCB latched		Mask: 0080h	All
				17.07 Meas.difference 4105 VDE-AR-N 4105 latched		Mask: 0040h	All

CAN Mux	CAN Byte	Size	Index	Description	Unit	Scale	Model
				17.06 Parameter alignment VDE-AR-N 4105 latched		Mask: 0020h	All
				17.05 Missing member VDE-AR-N 4105 latched		Mask: 0010h	All
				08.22 Busbar monitoring latched		Mask: 0008h	All
				08.21 Feedback GCB mismatch latched		Mask: 0004h	MARINE
				17.02 Reactive load share mismatch latched		Mask: 0002h	All
				17.01 Active load share mismatch latched		Mask: 0001h	All
6	5-6	uint16		Internal			
Subtopic Flexible Thresholds							
7	1-2	uint16	4175	BITLIST Alarms Flexible thresholds 1-16 active			
				Alarm flexible limit 16		Mask: 8000h	All
				Alarm flexible limit 15		Mask: 4000h	All
				Alarm flexible limit 14		Mask: 2000h	All
				Alarm flexible limit 13		Mask: 1000h	All
				Alarm flexible limit 12		Mask: 0800h	All
				Alarm flexible limit 11		Mask: 0400h	All
				Alarm flexible limit 10		Mask: 0200h	All
				Alarm flexible limit 9		Mask: 0100h	All
				Alarm flexible limit 8		Mask: 0080h	All
				Alarm flexible limit 7		Mask: 0040h	All
				Alarm flexible limit 6		Mask: 0020h	All
				Alarm flexible limit 5		Mask: 0010h	All
				Alarm flexible limit 4		Mask: 0008h	All
				Alarm flexible limit 3		Mask: 0004h	All
				Alarm flexible limit 2		Mask: 0002h	All
				Alarm flexible limit 1		Mask: 0001h	All
7	3-4	uint16	10279	BITLIST Alarms Flexible thresholds 1-16 latched (unacknowledged)			
				15.16 Flexible limit 16 latched		Mask: 8000h	All
				15.15 Flexible limit 15 latched		Mask: 4000h	All
				15.14 Flexible limit 14 latched		Mask: 2000h	All
				15.13 Flexible limit 13 latched		Mask: 1000h	All
				15.12 Flexible limit 12 latched		Mask: 0800h	All
				15.11 Flexible limit 11 latched		Mask: 0400h	All
				15.10 Flexible limit 10 latched		Mask: 0200h	All
				15.09 Flexible limit 9 latched		Mask: 0100h	All
				15.08 Flexible limit 8 latched		Mask: 0080h	All
				15.07 Flexible limit 7 latched		Mask: 0040h	All

CAN Mux	CAN Byte	Size	Index	Description	Unit	Scale	Model
				15.06 Flexible limit 6 latched		Mask: 0020h	All
				15.05 Flexible limit 5 latched		Mask: 0010h	All
				15.04 Flexible limit 4 latched		Mask: 0008h	All
				15.03 Flexible limit 3 latched		Mask: 0004h	All
				15.02 Flexible limit 2 latched		Mask: 0002h	All
				15.01 Flexible limit 1 latched		Mask: 0001h	All
7	5-6	uint16		Internal			
8	1-2	uint16	4177	BITLIST Alarms Flexible thresholds 17-32 active			
				Alarm flexible limit 32		Mask: 8000h	All
				Alarm flexible limit 31		Mask: 4000h	All
				Alarm flexible limit 30		Mask: 2000h	All
				Alarm flexible limit 29		Mask: 1000h	All
				Alarm flexible limit 28		Mask: 0800h	All
				Alarm flexible limit 27		Mask: 0400h	All
				Alarm flexible limit 26		Mask: 0200h	All
				Alarm flexible limit 25		Mask: 0100h	All
				Alarm flexible limit 24		Mask: 0080h	All
				Alarm flexible limit 23		Mask: 0040h	All
				Alarm flexible limit 22		Mask: 0020h	All
				Alarm flexible limit 21		Mask: 0010h	All
				Alarm flexible limit 20		Mask: 0008h	All
				Alarm flexible limit 19		Mask: 0004h	All
				Alarm flexible limit 18		Mask: 0002h	All
				Alarm flexible limit 17		Mask: 0001h	All
8	3-4	uint16	10280	BITLIST Alarms Flexible thresholds 17-32 latched (unacknowledged)			
				15.32 Flexible limit 32 latched		Mask: 8000h	All
				15.31 Flexible limit 31 latched		Mask: 4000h	All
				15.30 Flexible limit 30 latched		Mask: 2000h	All
				15.29 Flexible limit 29 latched		Mask: 1000h	All
				15.28 Flexible limit 28 latched		Mask: 0800h	All
				15.27 Flexible limit 27 latched		Mask: 0400h	All
				15.26 Flexible limit 26 latched		Mask: 0200h	All
				15.25 Flexible limit 25 latched		Mask: 0100h	All
				15.24 Flexible limit 24 latched		Mask: 0080h	All
				15.23 Flexible limit 23 latched		Mask: 0040h	All
				15.22 Flexible limit 22 latched		Mask: 0020h	All

9 Appendix

9.2.5 Protocol 5011 (Alarm Values Visualization)

CAN Mux	CAN Byte	Size	Index	Description	Unit	Scale	Model
				15.21 Flexible limit 21 latched		Mask: 0010h	All
				15.20 Flexible limit 20 latched		Mask: 0008h	All
				15.19 Flexible limit 19 latched		Mask: 0004h	All
				15.18 Flexible limit 18 latched		Mask: 0002h	All
				15.17 Flexible limit 17 latched		Mask: 0001h	All
8	5-6	uint16		Internal			
9	1-2	uint16	4179	BITLIST Alarms Flexible thresholds 33-40 active			
				Internal		Mask: 8000h	All
				Internal		Mask: 4000h	All
				Internal		Mask: 2000h	All
				Internal		Mask: 1000h	All
				Internal		Mask: 0800h	All
				Internal		Mask: 0400h	All
				Internal		Mask: 0200h	All
				Internal		Mask: 0100h	All
				Alarm flexible limit 40		Mask: 0080h	All
				Alarm flexible limit 39		Mask: 0040h	All
				Alarm flexible limit 38		Mask: 0020h	All
				Alarm flexible limit 37		Mask: 0010h	All
				Alarm flexible limit 36		Mask: 0008h	All
				Alarm flexible limit 35		Mask: 0004h	All
				Alarm flexible limit 34		Mask: 0002h	All
				Alarm flexible limit 33		Mask: 0001h	All
9	3-4	uint16	10281	BITLIST Alarms Flexible thresholds 33-40 latched (unacknowledged)			
				Internal		Mask: 8000h	All
				Internal		Mask: 4000h	All
				Internal		Mask: 2000h	All
				Internal		Mask: 1000h	All
				Internal		Mask: 0800h	All
				Internal		Mask: 0400h	All
				Internal		Mask: 0200h	All
				Internal		Mask: 0100h	All
				15.40 Flexible limit 40 latched		Mask: 0080h	All
				15.39 Flexible limit 39 latched		Mask: 0040h	All
				15.38 Flexible limit 38 latched		Mask: 0020h	All
				15.37 Flexible limit 37 latched		Mask: 0010h	All

CAN Mux	CAN Byte	Size	Index	Description	Unit	Scale	Model
				15.36 Flexible limit 36 latched		Mask: 0008h	All
				15.35 Flexible limit 35 latched		Mask: 0004h	All
				15.34 Flexible limit 34 latched		Mask: 0002h	All
				15.33 Flexible limit 33 latched		Mask: 0001h	All
9	5-6	uint16		0 (reserve)			
10	1-2	uint16	4194	BITLIST Free Alarms active			
				Free alarm 16		Mask: 8000h	All
				Free alarm 15		Mask: 4000h	All
				Free alarm 14		Mask: 2000h	All
				Free alarm 13		Mask: 1000h	All
				Free alarm 12		Mask: 0800h	All
				Free alarm 11		Mask: 0400h	All
				Free alarm 10		Mask: 0200h	All
				Free alarm 9		Mask: 0100h	All
				Free alarm 8		Mask: 0080h	All
				Free alarm 7		Mask: 0040h	All
				Free alarm 6		Mask: 0020h	All
				Free alarm 5		Mask: 0010h	All
				Free alarm 4 (same as Mux 6)		Mask: 0008h	All
				Free alarm 3 (same as Mux 6)		Mask: 0004h	All
				Free alarm 2 (same as Mux 6)		Mask: 0002h	All
				Free alarm 1 (same as Mux 6)		Mask: 0001h	All
10	3-4	uint16	10282	BITLIST Free Alarms latched (unacknowledged)			
				16.16 Free alarm 16 latched		Mask: 8000h	All
				16.15 Free alarm 15 latched		Mask: 4000h	All
				16.14 Free alarm 14 latched		Mask: 2000h	All
				16.13 Free alarm 13 latched		Mask: 1000h	All
				16.12 Free alarm 12 latched		Mask: 0800h	All
				16.11 Free alarm 11 latched		Mask: 0400h	All
				16.10 Free alarm 10 latched		Mask: 0200h	All
				16.09 Free alarm 9 latched		Mask: 0100h	All
				16.08 Free alarm 8 latched		Mask: 0080h	All
				16.07 Free alarm 7 latched		Mask: 0040h	All
				16.06 Free alarm 6 latched		Mask: 0020h	All
				16.05 Free alarm 5 latched		Mask: 0010h	All
				16.04 Free alarm 4 latched (same as Mux 6)		Mask: 0008h	All
				16.03 Free alarm 3 latched (same as Mux 6)		Mask: 0004h	All

CAN Mux	CAN Byte	Size	Index	Description	Unit	Scale	Model
				16.02 Free alarm 2 latched (same as Mux 6)		Mask: 0002h	All
				16.01 Free alarm 1 latched (same as Mux 6)		Mask: 0001h	All
10	5-6	uint16		Internal			
Subtopic Internal DC Analogue Values Wirebreak							
11	1-2	uint16	4171	BITLIST Alarms Analog Inputs 1 active			
				Internal		Mask: 8000h	All
				Internal		Mask: 4000h	All
				Internal		Mask: 2000h	All
				Internal		Mask: 1000h	All
				Internal		Mask: 0800h	All
				Internal		Mask: 0400h	All
				Internal		Mask: 0200h	All
				Internal		Mask: 0100h	All
				Internal		Mask: 0080h	All
				Internal		Mask: 0040h	All
				Internal		Mask: 0020h	All
				Failure Charging Alternator (D+)		Mask: 0010h	All
				Battery over voltage 2		Mask: 0008h	All
				Battery under voltage 2		Mask: 0004h	All
				Battery over voltage 1		Mask: 0002h	All
				Battery under voltage 1		Mask: 0001h	All
11	3-4	uint16	10136	Alarms Analog Inputs 1 latched (unacknowledged)			
				Internal		Mask: 8000h	All
				Internal		Mask: 4000h	All
				Internal		Mask: 2000h	All
				Internal		Mask: 1000h	All
				Internal		Mask: 0800h	All
				Internal		Mask: 0400h	All
				Internal		Mask: 0200h	All
				Internal		Mask: 0100h	All
				Internal		Mask: 0080h	All
				Internal		Mask: 0040h	All
				Internal		Mask: 0020h	All
				05.11 Failure Charging Alternator (D+)		Mask: 0010h	All
				08.02 Battery over voltage 2 latched		Mask: 0008h	All
				08.04 Battery under voltage 2 latched		Mask: 0004h	All
				08.01 Battery over voltage 1 latched		Mask: 0002h	All

CAN Mux	CAN Byte	Size	Index	Description	Unit	Scale	Model
				08.03 Battery under voltage 1 latched		Mask: 0001h	All
11	5-6	uint16		Internal			
12	1-2	uint16	4173	Alarms Analog Inputs Wire Break active			
				Internal		Mask: 0001h	
				Analog inp. 1, wire break		Mask: 0002h	All
				Analog inp. 2, wire break		Mask: 0004h	All
				Analog inp. 3, wire break		Mask: 0008h	All
				Analog inp. 4, wire break or shortcut		Mask: 0010h	EG3500XT-P2
				Analog inp. 5, wire break or shortcut		Mask: 0020h	EG3500XT-P2
				Analog inp. 6, wire break or shortcut		Mask: 0040h	EG3500XT-P2
				Analog inp. 7, wire break or shortcut		Mask: 0080h	EG3500XT-P2
				Analog inp. 8, wire break or shortcut		Mask: 0100h	EG3500XT-P2
				Analog inp. 9, wire break or shortcut		Mask: 0200h	EG3500XT-P2
				Analog inp. 10, wire break or shortcut		Mask: 0400h	EG3500XT-P2
				Internal		Mask: 0800h	
				Internal		Mask: 1000h	
				Internal		Mask: 2000h	
				Internal		Mask: 4000h	
				Internal		Mask: 8000h	
12	3-4	uint16	10137	Alarms Analog Inputs Wire Break latched (unacknowledged)			
				Internal		Mask: 0001h	
				10.01 Analog input 1 wire break		Mask: 0002h	All
				10.02 Analog input 2 wire break		Mask: 0004h	All
				10.03 Analog input 3 wire break		Mask: 0008h	All
				10.04 Analog input 4 wire break		Mask: 0010h	EG3500XT-P2
				10.05 Analog input 5 wire break		Mask: 0020h	EG3500XT-P2
				10.06 Analog input 6 wire break		Mask: 0040h	EG3500XT-P2
				10.07 Analog input 7 wire break		Mask: 0080h	EG3500XT-P2
				10.08 Analog input 8 wire break		Mask: 0100h	EG3500XT-P2
				10.09 Analog input 9 wire break		Mask: 0200h	EG3500XT-P2
				10.10 Analog input 10 wire break		Mask: 0400h	EG3500XT-P2
				Internal		Mask: 0800h	
				Internal		Mask: 1000h	
				Internal		Mask: 2000h	
				Internal		Mask: 4000h	
				Internal		Mask: 8000h	
12	5-6	uint16		Internal			

CAN Mux	CAN Byte	Size	Index	Description	Unit	Scale	Model
Subtopic Internal Digital Inputs							
13	1-2	uint16	4181	Alarms Digital Inputs 1 active			
				Discrete input 1		Mask: 8000h	All
				Discrete input 2		Mask: 4000h	All
				Discrete input 3		Mask: 2000h	All
				Discrete input 4		Mask: 1000h	All
				Discrete input 5		Mask: 0800h	All
				Discrete input 6		Mask: 0400h	All
				Discrete input 7		Mask: 0200h	All
				Discrete input 8		Mask: 0100h	All
				Discrete input 9		Mask: 0080h	All
				Discrete input 10		Mask: 0040h	All
				Discrete input 11		Mask: 0020h	All
				Discrete input 12		Mask: 0010h	All
				Internal		Mask: 0008h	
				Internal		Mask: 0004h	
				Internal		Mask: 0002h	
				Internal		Mask: 0001h	
13	3-4	uint16	10132	Alarms Digital Inputs 1 latched (unacknowledged)			
				09.01 Discrete input 1 latched		Mask: 8000h	All
				09.02 Discrete input 2 latched		Mask: 4000h	All
				09.03 Discrete input 3 latched		Mask: 2000h	All
				09.04 Discrete input 4 latched		Mask: 1000h	All
				09.05 Discrete input 5 latched		Mask: 0800h	All
				09.06 Discrete input 6 latched		Mask: 0400h	All
				09.07 Discrete input 7 latched		Mask: 0200h	All
				09.08 Discrete input 8 latched		Mask: 0100h	All
				09.09 Discrete input 9 latched		Mask: 0080h	All
				09.10 Discrete input 10 latched		Mask: 0040h	All
				09.11 Discrete input 11 latched		Mask: 0020h	All
				09.12 Discrete input 12 latched		Mask: 0010h	All
				Internal		Mask: 0008h	
				Internal		Mask: 0004h	
				Internal		Mask: 0002h	
				Internal		Mask: 0001h	
13	5-6	uint16		Internal			
14	1-2	uint16	4183	Alarms Digital Inputs 2 active			

CAN Mux	CAN Byte	Size	Index	Description	Unit	Scale	Model
				Digital Input 13		Mask: 8000h	EG3500XT-P2
				Digital Input 14		Mask: 4000h	EG3500XT-P2
				Digital Input 15		Mask: 2000h	EG3500XT-P2
				Digital Input 16		Mask: 1000h	EG3500XT-P2
				Digital Input 17		Mask: 0800h	EG3500XT-P2
				Digital Input 18		Mask: 0400h	EG3500XT-P2
				Digital Input 19		Mask: 0200h	EG3500XT-P2
				Digital Input 20		Mask: 0100h	EG3500XT-P2
				Digital Input 21		Mask: 0080h	EG3500XT-P2
				Digital Input 22		Mask: 0040h	EG3500XT-P2
				Digital Input 23		Mask: 0020h	EG3500XT-P2
				Internal		Mask: 0010h	
				Internal		Mask: 0008h	
				Internal		Mask: 0004h	
				Internal		Mask: 0002h	
				Internal		Mask: 0001h	
14	3-4	uint16	10283	Alarms Digital Inputs 2 latched (unacknowledged)			
				09.13 Discrete input 13 latched		Mask: 8000h	EG3500XT-P2
				09.14 Discrete input 14 latched		Mask: 4000h	EG3500XT-P2
				09.15 Discrete input 15 latched		Mask: 2000h	EG3500XT-P2
				09.16 Discrete input 16 latched		Mask: 1000h	EG3500XT-P2
				09.17 Discrete input 17 latched		Mask: 0800h	EG3500XT-P2
				09.18 Discrete input 18 latched		Mask: 0400h	EG3500XT-P2
				09.19 Discrete input 19 latched		Mask: 0200h	EG3500XT-P2
				09.20 Discrete input 20 latched		Mask: 0100h	EG3500XT-P2
				09.21 Discrete input 21 latched		Mask: 0080h	EG3500XT-P2
				09.22 Discrete input 22 latched		Mask: 0040h	EG3500XT-P2
				09.23 Discrete input 23 latched		Mask: 0020h	EG3500XT-P2
				Internal		Mask: 0010h	
				Internal		Mask: 0008h	
				Internal		Mask: 0004h	
				Internal		Mask: 0002h	
				Internal		Mask: 0001h	
14	5-6	uint16		Internal			
Subtopic External Digital Inputs							
15	1-2	uint16	4185	Alarms External Digital Inputs active			
				external Digital Input 16		Mask: 8000h	All

CAN Mux	CAN Byte	Size	Index	Description	Unit	Scale	Model
				external Digital Input 15		Mask: 4000h	All
				external Digital Input 14		Mask: 2000h	All
				external Digital Input 13		Mask: 1000h	All
				external Digital Input 12		Mask: 0800h	All
				external Digital Input 11		Mask: 0400h	All
				external Digital Input 10		Mask: 0200h	All
				external Digital Input 9		Mask: 0100h	All
				external Digital Input 8		Mask: 0080h	All
				external Digital Input 7		Mask: 0040h	All
				external Digital Input 6		Mask: 0020h	All
				external Digital Input 5		Mask: 0010h	All
				external Digital Input 4		Mask: 0008h	All
				external Digital Input 3		Mask: 0004h	All
				external Digital Input 2		Mask: 0002h	All
				external Digital Input 1		Mask: 0001h	All
15	3-4	uint16	16377	Alarms External Digital Inputs latched (unacknowledged)			
				12.16 External discrete input 16 latched		Mask: 8000h	All
				12.15 External discrete input 15 latched		Mask: 4000h	All
				12.14 External discrete input 14 latched		Mask: 2000h	All
				12.13 External discrete input 13 latched		Mask: 1000h	All
				12.12 External discrete input 12 latched		Mask: 0800h	All
				12.11 External discrete input 11 latched		Mask: 0400h	All
				12.10 External discrete input 10 latched		Mask: 0200h	All
				12.09 External discrete input 9 latched		Mask: 0100h	All
				12.08 External discrete input 8 latched		Mask: 0080h	All
				12.07 External discrete input 7 latched		Mask: 0040h	All
				12.06 External discrete input 6 latched		Mask: 0020h	All
				12.05 External discrete input 5 latched		Mask: 0010h	All
				12.04 External discrete input 4 latched		Mask: 0008h	All
				12.03 External discrete input 3 latched		Mask: 0004h	All
				12.02 External discrete input 2 latched		Mask: 0002h	All
				12.01 External discrete input 1 latched		Mask: 0001h	All
15	5-6	uint16		Internal			
16	1-2	uint16	4195	Alarm External Digital Inputs 1 active			
				external Digital Input 32		Mask: 8000h	All
				external Digital Input 31		Mask: 4000h	All
				external Digital Input 30		Mask: 2000h	All

CAN Mux	CAN Byte	Size	Index	Description	Unit	Scale	Model
				external Digital Input 29		Mask: 1000h	All
				external Digital Input 28		Mask: 0800h	All
				external Digital Input 27		Mask: 0400h	All
				external Digital Input 26		Mask: 0200h	All
				external Digital Input 25		Mask: 0100h	All
				external Digital Input 24		Mask: 0080h	All
				external Digital Input 23		Mask: 0040h	All
				external Digital Input 22		Mask: 0020h	All
				external Digital Input 21		Mask: 0010h	All
				external Digital Input 20		Mask: 0008h	All
				external Digital Input 19		Mask: 0004h	All
				external Digital Input 18		Mask: 0002h	All
				external Digital Input 17		Mask: 0001h	All
16	3-4	uint16	10284	Alarm External Digital Inputs 1 latched (unacknowledged)			
				12.32 External discrete input 32 latched		Mask: 8000h	All
				12.31 External discrete input 31 latched		Mask: 4000h	All
				12.30 External discrete input 30 latched		Mask: 2000h	All
				12.29 External discrete input 29 latched		Mask: 1000h	All
				12.28 External discrete input 28 latched		Mask: 0800h	All
				12.27 External discrete input 27 latched		Mask: 0400h	All
				12.26 External discrete input 26 latched		Mask: 0200h	All
				12.25 External discrete input 25 latched		Mask: 0100h	All
				12.24 External discrete input 24 latched		Mask: 0080h	All
				12.23 External discrete input 23 latched		Mask: 0040h	All
				12.22 External discrete input 22 latched		Mask: 0020h	All
				12.21 External discrete input 21 latched		Mask: 0010h	All
				12.20 External discrete input 20 latched		Mask: 0008h	All
				12.19 External discrete input 19 latched		Mask: 0004h	All
				12.18 External discrete input 18 latched		Mask: 0002h	All
				12.17 External discrete input 17 latched		Mask: 0001h	All
16	5-6	uint16		Internal			
Subtopic External DC Analogue Values Wirebreak							
17	1-2	uint16	4196	Alarms External Analog Inputs Wire Break active			
				Ext. analog inp. 1, wire break		Mask: 0001h	All
				Ext. analog inp. 2, wire break		Mask: 0002h	All
				Ext. analog inp. 3, wire break		Mask: 0004h	All

CAN Mux	CAN Byte	Size	Index	Description	Unit	Scale	Model
				Ext. analog inp. 4, wire break		Mask: 0008h	All
				Ext. analog inp. 5, wire break		Mask: 0010h	All
				Ext. analog inp. 6, wire break		Mask: 0020h	All
				Ext. analog inp. 7, wire break		Mask: 0040h	All
				Ext. analog inp. 8, wire break		Mask: 0080h	All
				Ext. analog inp. 9, wire break		Mask: 0100h	All
				Ext. analog inp. 10, wire break		Mask: 0200h	All
				Ext. analog inp. 11, wire break		Mask: 0400h	All
				Ext. analog inp. 12, wire break		Mask: 0800h	All
				Ext. analog inp. 13, wire break		Mask: 1000h	All
				Ext. analog inp. 14, wire break		Mask: 2000h	All
				Ext. analog inp. 15, wire break		Mask: 4000h	All
				Ext. analog inp. 16, wire break		Mask: 8000h	All
17	3-4	uint16	10285	Alarms External Analog Inputs Wire Break latched (unacknowledged)			
				25.01 Ext. analog input 1 wire break		Mask: 0001h	All
				25.02 Ext. analog input 2 wire break		Mask: 0002h	All
				25.03 Ext. analog input 3 wire break		Mask: 0004h	All
				25.04 Ext. analog input 4 wire break		Mask: 0008h	All
				25.05 Ext. analog input 5 wire break		Mask: 0010h	All
				25.06 Ext. analog input 6 wire break		Mask: 0020h	All
				25.07 Ext. analog input 7 wire break		Mask: 0040h	All
				25.08 Ext. analog input 8 wire break		Mask: 0080h	All
				25.09 Ext. analog input 9 wire break		Mask: 0100h	All
				25.10 Ext. analog input 10 wire break		Mask: 0200h	All
				25.11 Ext. analog input 11 wire break		Mask: 0400h	All
				25.12 Ext. analog input 12 wire break		Mask: 0800h	All
				25.13 Ext. analog input 13 wire break		Mask: 1000h	All
				25.14 Ext. analog input 14 wire break		Mask: 2000h	All
				25.15 Ext. analog input 15 wire break		Mask: 4000h	All
				25.16 Ext. analog input 16 wire break		Mask: 8000h	All
17	5-6	uint16		Internal			

9.2.6 Protocol 5014 (Based on Protocol 5003 but with enhancements)

Modbus-Address	CAN Mux	CAN Byte	Size	Index	Description	Unit	Scale	Model
50000	0	1-2	int16		Protocoll-ID, always 5014			All

9.2.6 Protocol 5014 (Based on Protocol 5003 but with enhancements)

Modbus-Address	CAN Mux	CAN Byte	Size	Index	Description	Unit	Scale	Model
50001	0	3-4	int16	10100	Engine speed	rpm	*1.0	All
50002	0	5-6	uint16		BITLIST			
					Control mode (STOP/AUTO/MANUAL/TEST) 1=AUTO - 04.01 Operation Mode Auto 2=STOP - 04.02 Operation Mode Stop 4=MANUAL - 04.03 Operation Mode Man 8=TEST - 04.03 Operation Mode Test		Mask: 000Fh	All
50003	1	1-2	int16	160	Gen. Powerfactor		*1000	All
50004	1	3-6	int32	170	Average Gen. Wye-Voltage	V	*10	All
50006	2	1-2	int16	144	Gen. Frequency	Hz	*100	All
50007	2	3-6	int32	171	Average Gen. Delta-Voltage	V	*10	All
50009	3	1-2	int16	147	Mains frequency	Hz	*100	All
50010	3	3-6	int32	173	Average Mains Wye-Voltage	V	*10	All
50012	4	1-2	int16	208	Mains power factor		*1000	All
50013	4	3-6	int32	174	Average Mains Delta-Voltage	V	*10	All
50015	5	1-2	int16	209	Busbar Frequency	Hz	*100	All
50016	5	3-6	int32	216	Average Busbar Delta-Voltage	V	*10	All
50018	6	1-2	uint16	4085	BITLIST			
					96.01 Internal Flag 1		Mask: 0001h	All
					96.02 Internal Flag 2		Mask: 0002h	All
					96.03 Internal Flag 3		Mask: 0004h	All
					96.04 Internal Flag 4		Mask: 0008h	All
					96.05 Internal Flag 5		Mask: 0010h	All
					96.06 Internal Flag 6		Mask: 0020h	All
					96.07 Internal Flag 7		Mask: 0040h	All
					96.08 Internal Flag 8		Mask: 0080h	All
					96.09 Internal Flag 9		Mask: 0100h	All
					96.10 Internal Flag 10		Mask: 0200h	All
					96.11 Internal Flag 11		Mask: 0400h	All
					96.12 Internal Flag 12		Mask: 0800h	All
					96.13 Internal Flag 13		Mask: 1000h	All
					96.14 Internal Flag 14		Mask: 2000h	All
					96.15 Internal Flag 15		Mask: 4000h	All
					96.16 Internal Flag 16		Mask: 8000h	All
50019	6	3-6	int32	234	Average Busbar Wye-Voltage	V	*10	EG3500XT-P2
50021	7	1-2	int16	10110	Battery voltage	V	*10	All

9 Appendix

9.2.6 Protocol 5014 (Based on Protocol 5003 but with enhancements)

Modbus-Address	CAN Mux	CAN Byte	Size	Index	Description	Unit	Scale	Model
50022	7	3-6	int32	207	Av. Mains Current	A	*1000	All
50024	8	1-2	int16	10111	Analog input 1		configurable	All
50025	8	3-6	int32	185	Av. Gen. Current	A	*1000	All
50027	9	1-2	int16	10112	Analog input 2		configurable	All
50028	9	3-6	int32	161	Meas. ground current	A	*1000	All
50030	10	1-2	int16	10115	Analog input 3		configurable	All
50031	10	3-6	int32	159	Calculated ground current	A	*1000	All
50033	11	1-2	int16	10117	Analog input 4		configurable	EG3500XT-P2
50034	11	3-6	int32	111	Gen. current 1	A	*1000	All
50036	12	1-2	int16	10151	Analog input 5		configurable	EG3500XT-P2
50037	12	3-6	int32	112	Gen. current 2	A	*1000	All
50039	13	1-2	int16	10152	Analog input 6		configurable	EG3500XT-P2
50040	13	3-6	int32	113	Gen. current 3	A	*1000	All
50042	14	1-2	int16	10153	Analog input 7		configurable	EG3500XT-P2
50043	14	3-6	int32	134	Mains current L1	A	*1000	All
50045	15	1-2	int16	10154	Analog input 8		configurable	EG3500XT-P2
50046	15	3-6	int32	231	Busbar Voltage L1-N	V	*1000	EG3500XT-P2
50048	16	1-2	int16	10155	Analog input 9		configurable	EG3500XT-P2
50049	16	3-6	int32	232	Busbar Voltage L2-N	V	*1000	EG3500XT-P2
50051	17	1-2	int16	10156	Analog input 10		configurable	EG3500XT-P2
50052	17	3-6	int32	135	Total Generator power	W	*1	All
50054	18	1-2			Internal			
50055	18	3-6	int32	140	External total mains power	W	*1	All
50057	19	1-2	int16	4086	BITLIST			All
					Operating Range Monitoring Code Number		Mask FF00h	All
					Operating range Error-Code ("0" means no failure)			
					The current segment number (One of 64 Segments possible)		Mask 00FFh	All
50058	19	3-6	int32	136	Total Generator reactive power	var	*1	All
50060	20	1-2	int16	10159	AI Auxiliary excitation D+	V	*10	All
50061	20	3-6	int32	150	External total mains reactive power	var	*1	All

Modbus-Address	CAN Mux	CAN Byte	Size	Index	Description	Unit	Scale	Model
50063	21	1-2	int16	10133	BITLIST			
					08.18 LM CANopen error at CAN Interface 1		Mask: 0001h	All
					05.10 LM Maintenance hours exceeded latched		Mask: 0002h	All
					05.09 LM Maintenance days exceeded latched		Mask: 0004h	All
					05.08 LM Start fail detected latched		Mask: 0008h	All
					08.10 LM General CAN-J1939 fault latched		Mask: 0010h	All
					08.08 LM MCB fail to open latched		Mask: 0020h	All
					08.07 LM MCB fail to close latched		Mask: 0040h	All
					08.06 LM GCB fail to open latched		Mask: 0080h	All
					08.05 LM GCB fail to close latched		Mask: 0100h	All
					05.06 LM Shutdown malfunction detected latched		Mask: 0200h	All
					05.07 LM Speed detection alarm latched		Mask: 0400h	All
					05.05 LM Unintended stop detected latched		Mask: 0800h	All
					05.04 LM Engine under speed 2 latched		Mask: 1000h	All
					05.03 LM Engine under speed 1 latched		Mask: 2000h	All
					05.02 LM Engine Over speed 2 latched		Mask: 4000h	All
					05.01 LM Engine Over speed 1 latched		Mask: 8000h	All
50064	21	3-6	int32	182	Busbar: Voltage L1-L2	V	*1	All
50066	22	1-2	int16	4087	BITLIST			
					08.30 Timeout Synchronisation GCB latched		Mask: 8000h	All
					08.31 Timeout Synchronisation MCB latched		Mask: 4000h	All
					08.32 Timeout Synchronisation GGB latched		Mask: 2000h	EG3500XT-P1 EG3500XT-P2
					05.11 Charge fail (D+ functionality) latched		Mask: 1000h	All
					Operating range failure 12		Mask: 0800h	All
					05.22 ECU Protect alarm latched		Mask: 0400h	All
					05.23 ECU Emission alarm latched		Mask: 0200h	All
					08.47 MCB failure 50BF		Mask: 0100h	
					08.46 GCB failure 50BF		Mask: 0080h	All
					08.29 CANopen error at CAN Interface 3		Mask: 0040h	EG3500XT-P1

9 Appendix

9.2.6 Protocol 5014 (Based on Protocol 5003 but with enhancements)

Modbus-Address	CAN Mux	CAN Byte	Size	Index	Description	Unit	Scale	Model
								EG3500XT-P2
					08.19 CANopen error at CAN Interface 2		Mask: 0020h	All
					08.16 Parameter Alignment LDSS		Mask: 0010h	All
					08.17 Missing members		Mask: 0008h	All
					08.48 MCB plausibility		Mask: 0004h	All
					05.13 ECU red lamp alarm latched		Mask: 0002h	All
					05.14 ECU yellow (amber) lamp alarm latched		Mask: 0001h	All
50067	22	3-6	int32	189	Busbar: Voltage L2-L3	V	*1	EG3500XT-P2
50069	23	1-2	int16	10286	BITLIST			
					08.53 LS interf.redundancy latched		Mask: 8000h	EG3500XT-P1 EG3500XT-P2
					Internal		Mask: 4000h	All
					Free alarm 4		Mask: 2000h	EG3000
					Free alarm 3		Mask: 1000h	EG3000
					Free alarm 2		Mask: 0800h	EG3000
					Free alarm 1		Mask: 0400h	EG3000
					Max. starts per time		Mask: 0200h	K36
					17.09 Neutral interl. reply mismatch latched		Mask: 0100h	All
					17.08 Decoupling GCB-MCB latched		Mask: 0080h	All
					17.07 Measurement difference 4105 latched		Mask: 0040h	All
					17.06 Parameter alignment 4105 latched		Mask: 0020h	All
					17.05 Missing member 4105 latched		Mask: 0010h	All
					08.22 Busbar v/f not ok latched		Mask: 0008h	All
					08.21 Feedback GCB mismatch latched		Mask: 0004h	MARINE
					17.02 Reactive load share mismatch latched		Mask: 0002h	All
					17.01 Active load share mismatch latched		Mask: 0001h	All
50070	23	3-6	int32	193	Busbar: Voltage L3-L1	V	*1	EG3500XT-P2
50072	24	1-2	int16	10134	BITLIST			
					06.01 Generator over frequency 1 latched		Mask: 8000h	All
					06.02 Generator over frequency 2 latched		Mask: 4000h	All

Modbus-Address	CAN Mux	CAN Byte	Size	Index	Description	Unit	Scale	Model
					06.03 Generator under frequency 1 latched		Mask: 2000h	All
					06.04 Generator under frequency 2 latched		Mask: 1000h	All
					06.05 Generator over voltage 1 latched		Mask: 0800h	All
					06.06 Generator over voltage 2 latched		Mask: 0400h	All
					06.07 Generator under voltage 1 latched		Mask: 0200h	All
					06.08 Generator under voltage 2 latched		Mask: 0100h	All
					06.09 Generator over current 1 latched		Mask: 0080h	All
					06.10 Generator over current 2 latched		Mask: 0040h	All
					06.11 Generator over current 3 latched		Mask: 0020h	All
					06.12 Reverse / reduced power 1 latched		Mask: 0010h	All
					06.13 Reverse / reduced power 2 latched		Mask: 0008h	All
					06.14 Generator overload IOP 1 latched		Mask: 0004h	All
					06.15 Generator overload IOP 2 latched		Mask: 0002h	All
					06.34 Busbar phase rotation mismatch		Mask: 0001h	EG3500XT-P2
50073	24	3-6	int32	108	Gen. voltage L1-L2	V	*1	
50075	25	1-2	int16	10138	BITLIST			
					06.16 Generator unbalanced load 1 latched		Mask: 8000h	All
					06.17 Generator unbalanced load 2 latched		Mask: 4000h	All
					06.18 Generator voltage asymmetry latched		Mask: 2000h	All
					06.19 Ground fault 1 latched		Mask: 1000h	All
					06.20 Ground fault 2 latched		Mask: 0800h	All
					06.21 Gen. Phase Rotation mismatch Latched		Mask: 0400h	All
					06.29 Gen. active power mismatch Latched		Mask: 0200h	All
					06.30 Generator unloading mismatch Latched		Mask: 0100h	All
					06.22 Inverse time over current Latched		Mask: 0080h	All
					06.31 Operating Range failed latched		Mask: 0040h	All
					06.23 Generator overload MOP 1 latched		Mask: 0020h	All
					06.24 Generator overload MOP 2 latched		Mask: 0010h	All
					06.25 Gen.Power Factor lagging 1 latched		Mask: 0008h	All

9 Appendix

9.2.6 Protocol 5014 (Based on Protocol 5003 but with enhancements)

Modbus-Address	CAN Mux	CAN Byte	Size	Index	Description	Unit	Scale	Model
					06.26 Gen.Power Factor lagging 2 latched		Mask: 0004h	All
					06.27 Gen.Power Factor leading 1 latched		Mask: 0002h	All
					06.28 Gen.Power Factor leading 2 latched		Mask: 0001h	All
50076	25	3-6	int32	114	Gen. voltage L1-N	V	*1	All
50078	26	1-2	int16	10135	BITLIST			
					07.06 Mains over frequency 1 latched		Mask: 8000h	All
					07.07 Mains over frequency 2 latched		Mask: 4000h	All
					07.08 Mains under frequency 1 latched		Mask: 2000h	All
					07.09 Mains under frequency 2 latched		Mask: 1000h	All
					07.10 Mains over voltage 1 latched		Mask: 0800h	All
					07.11 Mains over voltage 2 latched		Mask: 0400h	All
					07.12 Mains under voltage 1 latched		Mask: 0200h	All
					07.13 Mains under voltage 2 latched		Mask: 0100h	All
					07.14 Mains Phase shift latched		Mask: 0080h	All
					07.25 Mains decoupling latched		Mask: 0040h	All
					07.32 Mains AC Wiring		Mask: 0020h	All
					Internal		Mask: 0010h	
					Internal		Mask: 0008h	
					07.05 Mains Phase rotation mismatch latched		Mask: 0004h	All
					Internal		Mask: 0002h	
					Internal		Mask: 0001h	
50079	26	3-6	int32	109	Gen. voltage L2-L3	V	*1	All
50081	27	1-2	int16	10278	BITLIST			
					07.21 Mains import power 1 latched		Mask: 8000h	All
					07.22 Mains import power 2 latched		Mask: 4000h	All
					07.23 Mains export power 1 latched		Mask: 2000h	All
					07.24 Mains export power 2 latched		Mask: 1000h	All
					07.17 Mains PF lagging 1 latched		Mask: 0800h	All
					07.18 Mains PF lagging 2 latched		Mask: 0400h	All
					07.19 Mains PF leading 1 latched		Mask: 0200h	All
					07.20 Mains PF leading 2 latched		Mask: 0100h	All
					07.15 Mains df/dt latched		Mask: 0080h	All
					07.16 Mains active power mismatch latched		Mask: 0040h	All
					07.28 Mains Time-dep. Voltage (FRT) latched		Mask: 0020h	All

9.2.6 Protocol 5014 (Based on Protocol 5003 but with enhancements)

Modbus-Address	CAN Mux	CAN Byte	Size	Index	Description	Unit	Scale	Model
					Internal		Mask: 0010h	
					07.27 Mains slow voltage increase (10 min)		Mask: 0008h	All
					Internal		Mask: 0004h	
					07.29 QU Monitoring step 1 tripped		Mask: 0002h	All
					07.30 QU Monitoring step 2 tripped		Mask: 0001h	All
50082	27	3-6	int32	115	Gen. voltage L2-N	V	*1	All
50084	28	1-2	int16	10132	BITLIST			
					09.01 Discrete input 1 latched		Mask: 8000h	All
					09.02 Discrete input 2 latched		Mask: 4000h	All
					09.03 Discrete input 3 latched		Mask: 2000h	All
					09.04 Discrete input 4 latched		Mask: 1000h	All
					09.05 Discrete input 5 latched		Mask: 0800h	All
					09.06 Discrete input 6 latched		Mask: 0400h	All
					09.07 Discrete input 7 latched		Mask: 0200h	All
					09.08 Discrete input 8 latched		Mask: 0100h	All
					09.09 Discrete input 9 latched		Mask: 0080h	All
					09.10 Discrete input 10 latched		Mask: 0040h	All
					09.11 Discrete input 11 latched		Mask: 0020h	All
					09.12 Discrete input 12 latched		Mask: 0010h	All
					Internal		Mask: 0008h	
					Internal		Mask: 0004h	
					Internal		Mask: 0002h	
					Internal		Mask: 0001h	
50085	28	3-6	int32	110	Gen. voltage L3-L1	V	*1	EG3000
50087	29	1-2	int16	10283	BITLIST			
					09.13 Discrete input 13 latched		Mask: 8000h	EG3500XT-P2
					09.14 Discrete input 14 latched		Mask: 4000h	EG3500XT-P2
					09.15 Discrete input 15 latched		Mask: 2000h	EG3500XT-P2
					09.16 Discrete input 16 latched		Mask: 1000h	EG3500XT-P2
					09.17 Discrete input 17 latched		Mask: 0800h	EG3500XT-P2
					09.18 Discrete input 18 latched		Mask: 0400h	EG3500XT-P2
					09.19 Discrete input 19 latched		Mask: 0200h	EG3500XT-P2
					09.20 Discrete input 20 latched		Mask: 0100h	EG3500XT-P2

9 Appendix

9.2.6 Protocol 5014 (Based on Protocol 5003 but with enhancements)

Modbus-Address	CAN Mux	CAN Byte	Size	Index	Description	Unit	Scale	Model
					09.21 Discrete input 21 latched		Mask: 0080h	EG3500XT-P2
					09.22 Discrete input 22 latched		Mask: 0040h	EG3500XT-P2
					09.23 Discrete input 23 latched		Mask: 0020h	EG3500XT-P2
					Internal		Mask: 0010h	
					Internal		Mask: 0008h	
					Internal		Mask: 0004h	
					Internal		Mask: 0002h	
					Internal		Mask: 0001h	
50088	29	3-6	int32	116	Gen. voltage L3-N	V	*1	All
50090	30	1-2	int16	16377	BITLIST			
					12.16 External discrete input 16 latched		Mask: 8000h	All
					12.15 External discrete input 15 latched		Mask: 4000h	All
					12.14 External discrete input 14 latched		Mask: 2000h	All
					12.13 External discrete input 13 latched		Mask: 1000h	All
					12.12 External discrete input 12 latched		Mask: 0800h	All
					12.11 External discrete input 11 latched		Mask: 0400h	All
					12.10 External discrete input 10 latched		Mask: 0200h	All
					12.09 External discrete input 9 latched		Mask: 0100h	All
					12.08 External discrete input 8 latched		Mask: 0080h	All
					12.07 External discrete input 7 latched		Mask: 0040h	All
					12.06 External discrete input 6 latched		Mask: 0020h	All
					12.05 External discrete input 5 latched		Mask: 0010h	All
					12.04 External discrete input 4 latched		Mask: 0008h	All
					12.03 External discrete input 3 latched		Mask: 0004h	All
					12.02 External discrete input 2 latched		Mask: 0002h	All
					12.01 External discrete input 1 latched		Mask: 0001h	All
50091	30	3-6	int32	118	Mains voltage L1-L2	V	*1	All
50093	31	1-2	int16	10279	BITLIST			
					15.16 Flexible limit 16 latched		Mask: 8000h	All
					15.15 Flexible limit 15 latched		Mask: 4000h	All
					15.14 Flexible limit 14 latched		Mask: 2000h	All
					15.13 Flexible limit 13 latched		Mask: 1000h	All
					15.12 Flexible limit 12 latched		Mask: 0800h	All
					15.11 Flexible limit 11 latched		Mask: 0400h	All
					15.10 Flexible limit 10 latched		Mask: 0200h	All
					15.09 Flexible limit 9 latched		Mask: 0100h	All

9.2.6 Protocol 5014 (Based on Protocol 5003 but with enhancements)

Modbus-Address	CAN Mux	CAN Byte	Size	Index	Description	Unit	Scale	Model
					15.08 Flexible limit 8 latched		Mask: 0080h	All
					15.07 Flexible limit 7 latched		Mask: 0040h	All
					15.06 Flexible limit 6 latched		Mask: 0020h	All
					15.05 Flexible limit 5 latched		Mask: 0010h	All
					15.04 Flexible limit 4 latched		Mask: 0008h	All
					15.03 Flexible limit 3 latched		Mask: 0004h	All
					15.02 Flexible limit 2 latched		Mask: 0002h	All
					15.01 Flexible limit 1 latched		Mask: 0001h	All
50094	31	3-6	int32	121	Mains voltage L1-N	V	*1	All
50096	32	1-2	int16	10280	BITLIST			
					15.32 Flexible limit 32 latched		Mask: 8000h	All
					15.31 Flexible limit 31 latched		Mask: 4000h	All
					15.30 Flexible limit 30 latched		Mask: 2000h	All
					15.29 Flexible limit 29 latched		Mask: 1000h	All
					15.28 Flexible limit 28 latched		Mask: 0800h	All
					15.27 Flexible limit 27 latched		Mask: 0400h	All
					15.26 Flexible limit 26 latched		Mask: 0200h	All
					15.25 Flexible limit 25 latched		Mask: 0100h	All
					15.24 Flexible limit 24 latched		Mask: 0080h	All
					15.23 Flexible limit 23 latched		Mask: 0040h	All
					15.22 Flexible limit 22 latched		Mask: 0020h	All
					15.21 Flexible limit 21 latched		Mask: 0010h	All
					15.20 Flexible limit 20 latched		Mask: 0008h	All
					15.19 Flexible limit 19 latched		Mask: 0004h	All
					15.18 Flexible limit 18 latched		Mask: 0002h	All
					15.17 Flexible limit 17 latched		Mask: 0001h	All
50097	32	3-6	int32	119	Mains voltage L2-L3	V	*1	All
50099	33	1-2	int16	10281	BITLIST			
					Internal		Mask: 8000h	
					Internal		Mask: 4000h	
					Internal		Mask: 2000h	
					Internal		Mask: 1000h	
					Internal		Mask: 0800h	
					Internal		Mask: 0400h	
					Internal		Mask: 0200h	
					Internal		Mask: 0100h	
					15.40 Flexible limit 40 latched		Mask: 0080h	All

9 Appendix

9.2.6 Protocol 5014 (Based on Protocol 5003 but with enhancements)

Modbus-Address	CAN Mux	CAN Byte	Size	Index	Description	Unit	Scale	Model
					15.39 Flexible limit 39 latched		Mask: 0040h	All
					15.38 Flexible limit 38 latched		Mask: 0020h	All
					15.37 Flexible limit 37 latched		Mask: 0010h	All
					15.36 Flexible limit 36 latched		Mask: 0008h	All
					15.35 Flexible limit 35 latched		Mask: 0004h	All
					15.34 Flexible limit 34 latched		Mask: 0002h	All
					15.33 Flexible limit 33 latched		Mask: 0001h	All
50100	33	3-6	int32	122	Mains voltage L2-N	V	*1	All
50102	34	1-2	int16	4088	BITLIST			
					Internal		Mask: 8000h	All
					Internal		Mask: 4000h	All
					Internal		Mask: 2000h	All
					Internal		Mask: 1000h	All
					Internal		Mask: 0800h	All
					Internal		Mask: 0400h	All
					Internal		Mask: 0200h	All
					Internal		Mask: 0100h	All
					Internal		Mask: 0080h	All
					Internal		Mask: 0040h	All
					Internal		Mask: 0020h	
					Internal		Mask: 0010h	All
					08.02 Battery over voltage 2 latched		Mask: 0008h	All
					08.04 Battery under voltage 2 latched		Mask: 0004h	All
					08.01 Battery over voltage 1 latched		Mask: 0002h	All
					08.03 Battery under voltage 1 latched		Mask: 0001h	All
50103	34	3-6	int32	120	Mains voltage L3-L1	V	*1	All
50105	35	1-2	int16	4089	BITLIST			
					01.11 New Alarm triggered		Mask: 8000h	All
					Internal		Mask: 4000h	
					Internal		Mask: 2000h	
					Internal		Mask: 1000h	
					Internal		Mask: 0800h	
					Internal		Mask: 0400h	
					Internal		Mask: 0200h	
					Internal		Mask: 0100h	
					Internal		Mask: 0080h	
					Internal		Mask: 0040h	

9.2.6 Protocol 5014 (Based on Protocol 5003 but with enhancements)

Modbus-Address	CAN Mux	CAN Byte	Size	Index	Description	Unit	Scale	Model
					01.06 Alarm class F latched		Mask: 0020h	All
					01.05 Alarm class E latched		Mask: 0010h	All
					01.04 Alarm class D latched		Mask: 0008h	All
					01.03 Alarm class C latched		Mask: 0004h	All
					01.02 Alarm class B latched		Mask: 0002h	All
					01.01 Alarm class A latched		Mask: 0001h	All
50106	35	3-6	int32	123	Mains voltage L3-N	V	*1	All
50108	36	1-2	int16	10137	BITLIST			
					Internal		Mask: 0001h	
					10.01 Analog input 1 wire break		Mask: 0002h	All
					10.02 Analog input 2 wire break		Mask: 0004h	All
					10.03 Analog input 3 wire break		Mask: 0008h	All
					10.04 Analog input 4 wire break		Mask: 0010h	EG3500XT-P2
					10.05 Analog input 5 wire break		Mask: 0020h	EG3500XT-P2
					10.06 Analog input 6 wire break		Mask: 0040h	EG3500XT-P2
					10.07 Analog input 7 wire break		Mask: 0080h	EG3500XT-P2
					10.08 Analog input 8 wire break		Mask: 0100h	EG3500XT-P2
					10.09 Analog input 9 wire break		Mask: 0200h	EG3500XT-P2
					10.10 Analog input 10 wire break		Mask: 0400h	EG3500XT-P2
					Internal		Mask: 0800h	
					Internal		Mask: 1000h	
					Internal		Mask: 2000h	
					Internal		Mask: 4000h	
					Internal		Mask: 8000h	
50109	36	3-4	int16	15310	SPN 2629 Turbo Charger 1 temp	°C	*1	All
50110	36	5-6	int16	10285	BITLIST			
					25.01 Ext. analog input 1 wire break		Mask: 0001h	All
					25.02 Ext. analog input 2 wire break		Mask: 0002h	All
					25.03 Ext. analog input 3 wire break		Mask: 0004h	All
					25.04 Ext. analog input 4 wire break		Mask: 0008h	All
					25.05 Ext. analog input 5 wire break		Mask: 0010h	All
					25.06 Ext. analog input 6 wire break		Mask: 0020h	All
					25.07 Ext. analog input 7 wire break		Mask: 0040h	All
					25.08 Ext. analog input 8 wire break		Mask: 0080h	All

9 Appendix

9.2.6 Protocol 5014 (Based on Protocol 5003 but with enhancements)

Modbus-Address	CAN Mux	CAN Byte	Size	Index	Description	Unit	Scale	Model
					25.09 Ext. analog input 9 wire break		Mask: 0100h	All
					25.10 Ext. analog input 10 wire break		Mask: 0200h	All
					25.11 Ext. analog input 11 wire break		Mask: 0400h	All
					25.12 Ext. analog input 12 wire break		Mask: 0800h	All
					25.13 Ext. analog input 13 wire break		Mask: 1000h	All
					25.14 Ext. analog input 14 wire break		Mask: 2000h	All
					25.15 Ext. analog input 15 wire break		Mask: 4000h	All
					25.16 Ext. analog input 16 wire break		Mask: 8000h	All
50111	37	1-2	int16	10107	BITLIST			
					13.01 Relay-Output 1 (Self-test-relay)		Mask: 8000h	All
					13.02 Relay-Output 2		Mask: 4000h	All
					13.03 Relay-Output 3		Mask: 2000h	All
					13.04 Relay-Output 4		Mask: 1000h	All
					13.05 Relay-Output 5		Mask: 0800h	All
					13.06 Relay-Output 6		Mask: 0400h	All
					13.07 Relay-Output 7		Mask: 0200h	All
					13.08 Relay-Output 8		Mask: 0100h	All
					13.09 Relay-Output 9		Mask: 0080h	All
					13.10 Relay-Output 10		Mask: 0040h	All
					13.11 Relay-Output 11		Mask: 0020h	All
					13.12 Relay-Output 12		Mask: 0010h	All
					Internal		Mask: 0008h	
					Internal		Mask: 0004h	
					Internal		Mask: 0002h	
					Internal		Mask: 0001h	
50112	37	3-4	int16	10109	BITLIST			
					13.13 Relay-Output 13		Mask: 8000h	EG3500XT-P2
					13.14 Relay-Output 14		Mask: 4000h	EG3500XT-P2
					13.15 Relay-Output 15		Mask: 2000h	EG3500XT-P2
					13.16 Relay-Output 16		Mask: 1000h	EG3500XT-P2
					13.17 Relay-Output 17		Mask: 0800h	EG3500XT-P2
					13.18 Relay-Output 18		Mask: 0400h	EG3500XT-P2
					13.19 Relay-Output 19		Mask: 0200h	EG3500XT-P2

Modbus-Address	CAN Mux	CAN Byte	Size	Index	Description	Unit	Scale	Model
					13.20 Relay-Output 20		Mask: 0100h	EG3500XT-P2
					13.21 Relay-Output 21		Mask: 0080h	EG3500XT-P2
					13.22 Relay-Output 22		Mask: 0040h	EG3500XT-P2
					Internal		Mask: 0020h	
					Internal		Mask: 0010h	
					Internal		Mask: 0008h	
					Internal		Mask: 0004h	
					13.34 Transistor output 2		Mask: 0002h	EG3500XT-P2
					13.33 Transistor output 1		Mask: 0001h	EG3500XT-P2
50113	37	5-6	int16	8005	BITLIST			
					98.16 LM External DO 16		Mask: 8000h	All
					98.15 LM External DO 15		Mask: 4000h	All
					98.14 LM External DO 14		Mask: 2000h	All
					98.13 LM External DO 13		Mask: 1000h	All
					98.12 LM External DO 12		Mask: 0800h	All
					98.11 LM External DO 11		Mask: 0400h	All
					98.10 LM External DO 10		Mask: 0200h	All
					98.09 LM External DO 9		Mask: 0100h	All
					98.08 LM External DO 8		Mask: 0080h	All
					98.07 LM External DO 7		Mask: 0040h	All
					98.06 LM External DO 6		Mask: 0020h	All
					98.05 LM External DO 5		Mask: 0010h	All
					98.04 LM External DO 4		Mask: 0008h	All
					98.03 LM External DO 3		Mask: 0004h	All
					98.02 LM External DO 2		Mask: 0002h	All
					98.01 LM External DO 1		Mask: 0001h	All
50114	38	1-2	int16	10310	Analog output 1		configurable	All
50115	38	3-4	int16	10311	Analog output 2		configurable	All
50116	38	5-6	int16	10317	Analog output 3		configurable	EG3500XT-P2
50117	39	1-2	int16	10318	Analog output 4		configurable	EG3500XT-P2
50118	39	3-4	int16	10319	Analog output 5		configurable	EG3500XT-P2
50119	39	5-6	int16	10320	Analog output 6		configurable	EG3500XT-P2

9 Appendix

9.2.6 Protocol 5014 (Based on Protocol 5003 but with enhancements)

Modbus-Address	CAN Mux	CAN Byte	Size	Index	Description	Unit	Scale	Model
50120	40	1-2	int16	10202	Status message. This is an index number. Refer to manual chapter Status messages for more information.			All
50121	40	3-6	uint32	2520	Gen. real energy	MWh	*100	All
50123	41	1-2	uint16	2540	Engine, number of start requests		*1	All
50124	41	3-6	uint32	2522	Gen. positive reactive energy	Mvarh	*100	All
50126	42	1-2	int16	2558	Hours until next maintenance	h	*10	All
50127	42	3-6	uint32	2568	Gen. hours of operation	h	*100	All
50129	43	1-2	int16	5541	Setpoint frequency	Hz	*100	All
50130	43	3-6	int32	5542	Setpoint active power	kW	*10	All
50132	44	1-4	int32	5640	Setpoint voltage	V	*1	All
50134	44	5-6	int16	5641	Setpoint power factor		*1000	All
50135	45	1-2	int16	4090	BITLIST			
					Idle mode OR Ramp to rated		Mask: 8000h	All
					04.15 Idle run is active		Mask: 4000h	All
					04.12 Start without closing GCB		Mask: 2000h	All
					04.64 Key activation		Mask: 1000h	All
					A manual START has been requested		Mask: 0800h	All
					A manual STOP has been requested		Mask: 0400h	All
					04.10 Cooldown is active		Mask: 0200h	All
					03.01 Auxiliary Services is active		Mask: 0100h	All
					03.07 Engine monitoring delay expired		Mask: 0080h	All
					03.08 Breaker delay timer has expired		Mask: 0040h	All
					03.25 Engine shall run		Mask: 0020h	All
					04.27 Critical mode is active		Mask: 0010h	All
					03.06 Engine release is active		Mask: 0008h	All
					03.30 Auxiliary services prerun is active		Mask: 0004h	All
					03.31 Auxiliary services postrun is active		Mask: 0002h	All
					04.61 Lamp test request		Mask: 0001h	All
50136	45	3-4	int16	4091	BITLIST			
					03.02 Starter / Crank is active		Mask: 8000h	All
					03.28 Operating Magnet / Gasrelay is active		Mask: 4000h	All
					03.04 Preglow or Ignition is active		Mask: 2000h	All
					04.11 Mains settling		Mask: 1000h	All
					04.09 Emergency mode is currently active		Mask: 0800h	All
					03.40 Remote Shutdown (ID503, Bit9)		Mask: 0400h	All

Modbus-Address	CAN Mux	CAN Byte	Size	Index	Description	Unit	Scale	Model
					03.37 Free PID Controller 3: Lower Command		Mask: 0200h	All
					03.36 Free PID Controller 3: Raise Command		Mask: 0100h	All
					03.35 Free PID Controller 2: Lower Command		Mask: 0080h	All
					03.34 Free PID Controller 2: Raise Command		Mask: 0040h	All
					03.27 Stop solenoid is active		Mask: 0020h	All
					03.24 Excitation enabled (Run-up Synchronization)		Mask: 0010h	All
					The genset runs mains parallel		Mask: 0008h	All
					03.33 Free PID Controller 1: Lower Command		Mask: 0004h	All
					03.32 Free PID Controller 1: Raise Command		Mask: 0002h	All
					Increment Engine Start Counter		Mask: 0001h	All
50137	45	5-6	int16	4155	BITLIST			
					03.20 3-Pos. Controller Freq./Power raise		Mask: 8000h	All
					03.21 3-Pos. Controller Freq./Power lower		Mask: 4000h	All
					03.22 3-Pos. Controller Volt./ReactPow raise		Mask: 2000h	All
					03.23 3-Pos. Controller Volt./ReactPow lower		Mask: 1000h	All
					04.06 GCB is closed		Mask: 0800h	All
					04.07 MCB is closed		Mask: 0400h	All
					05.16 Derating active (J1939 or freely)		Mask: 0200h	All
					04.18 Synchronisation GCB procedure is active		Mask: 0100h	All
					04.19 Opening GCB relay is active		Mask: 0080h	All
					04.20 Close command GCB is active		Mask: 0040h	All
					04.21 Synchronisation MCB procedure is active		Mask: 0020h	All
					04.22 Open command MCB is active		Mask: 0010h	All
					04.23 Close command MCB is active		Mask: 0008h	All
					04.28 Unloading generator is active		Mask: 0004h	All
					04.29 Unloading mains is active		Mask: 0002h	All
					04.30 Power limited prurun		Mask: 0001h	All
50138	46	1-2	int16	4156	BITLIST			
					04.16 GGB is closed		Mask: 8000h	EG3500XT-P1 EG3500XT-P2

9 Appendix

9.2.6 Protocol 5014 (Based on Protocol 5003 but with enhancements)

Modbus-Address	CAN Mux	CAN Byte	Size	Index	Description	Unit	Scale	Model
					04.17 GGB is released		Mask: 4000h	EG3500XT-P1 EG3500XT-P2
					04.24 Synchronisation GGB procedure is active		Mask: 2000h	EG3500XT-P1 EG3500XT-P2
					04.25 Open command GGB is active		Mask: 1000h	EG3500XT-P1 EG3500XT-P2
					04.26 Close command GGB is active		Mask: 0800h	EG3500XT-P1 EG3500XT-P2
					Dead busbar closure requ. for GCB,MCB or GGB		Mask: 0400h	All
					4.62 Active power load share is active		Mask: 0200h	All
					4.63 Reactive power load share is active		Mask: 0100h	All
					Generator with a closed GCB is requested		Mask: 0080h	All
					LDSS: The Engine shall start		Mask: 0040h	All
					LDSS: The Engine shall stop		Mask: 0020h	All
					LDSS: The Engine shall stop, if possible		Mask: 0010h	All
					LDSS: Minimum Running Time is active		Mask: 0008h	All
					04.43 The LDSS function is active		Mask: 0004h	All
					04.60 Critical mode postrun		Mask: 0002h	All
					AUTOMATIC Run: Switch to Operating Mode STOP		Mask: 0001h	All
50139	46	3-4	int16	4092	BITLIST			
					04.13 Remote Start request		Mask: 8000h	All
					04.14 Remote acknowledge		Mask: 4000h	All
					Internal		Mask: 2000h	All
					86.25 LM Frequency Droop active		Mask: 1000h	All
					86.26 LM Voltage Droop active		Mask: 0800h	All
					Synchronization mode Check active		Mask: 0400h	All
					Synchronization mode Permissive active		Mask: 0200h	All
					Synchronization mode Run active		Mask: 0100h	All
					86.85 LM Enable MCB		Mask: 0080h	All
					Internal		Mask: 0040h	

9.2.6 Protocol 5014 (Based on Protocol 5003 but with enhancements)

Modbus-Address	CAN Mux	CAN Byte	Size	Index	Description	Unit	Scale	Model
					Internal		Mask: 0020h	
					Internal		Mask: 0010h	
					Internal		Mask: 0008h	
					Internal		Mask: 0004h	
					Internal		Mask: 0002h	
					Internal		Mask: 0001h	
50140	46	5-6	int16	10284	BITLIST			
					12.32 External discrete input 32 latched		Mask: 8000h	All
					12.31 External discrete input 31 latched		Mask: 4000h	All
					12.30 External discrete input 30 latched		Mask: 2000h	All
					12.29 External discrete input 29 latched		Mask: 1000h	All
					12.28 External discrete input 28 latched		Mask: 0800h	All
					12.27 External discrete input 27 latched		Mask: 0400h	All
					12.26 External discrete input 26 latched		Mask: 0200h	All
					12.25 External discrete input 25 latched		Mask: 0100h	All
					12.24 External discrete input 24 latched		Mask: 0080h	All
					12.23 External discrete input 23 latched		Mask: 0040h	All
					12.22 External discrete input 22 latched		Mask: 0020h	All
					12.21 External discrete input 21 latched		Mask: 0010h	All
					12.20 External discrete input 20 latched		Mask: 0008h	All
					12.19 External discrete input 19 latched		Mask: 0004h	All
					12.18 External discrete input 18 latched		Mask: 0002h	All
					12.17 External discrete input 17 latched		Mask: 0001h	All
50141	47	1-2	int16	8009	BITLIST			
					98.32 LM External DO 32		Mask: 8000h	All
					98.31 LM External DO 31		Mask: 4000h	All
					98.30 LM External DO 30		Mask: 2000h	All
					98.29 LM External DO 29		Mask: 1000h	All
					98.28 LM External DO 28		Mask: 0800h	All
					98.27 LM External DO 27		Mask: 0400h	All
					98.26 LM External DO 26		Mask: 0200h	All
					98.25 LM External DO 25		Mask: 0100h	All
					98.24 LM External DO 24		Mask: 0080h	All
					98.23 LM External DO 23		Mask: 0040h	All
					98.22 LM External DO 22		Mask: 0020h	All
					98.21 LM External DO 21		Mask: 0010h	All
					98.20 LM External DO 20		Mask: 0008h	All

9 Appendix

9.2.6 Protocol 5014 (Based on Protocol 5003 but with enhancements)

Modbus-Address	CAN Mux	CAN Byte	Size	Index	Description	Unit	Scale	Model
					98.19 LM External DO 19		Mask: 0004h	All
					98.18 LM External DO 18		Mask: 0002h	All
					98.17 LM External DO 17		Mask: 0001h	All
50142	47	3-4	int16	10170	External Analog input 1		configurable	All
50143	47	5-6	int16	10171	External Analog input 2		configurable	All
50144	48	1-2	int16	10172	External Analog input 3		configurable	All
50145	48	3-4	int16	10173	External Analog input 4		configurable	All
50146	48	5-6	int16	10174	External Analog input 5		configurable	All
50147	49	1-2	int16	10175	External Analog input 6		configurable	All
50148	49	3-4	int16	10176	External Analog input 7		configurable	All
50149	49	5-6	int16	10177	External Analog input 8		configurable	All
50150	50	1-2	int16	10178	External Analog input 9		configurable	All
50151	50	3-4	int16	10179	External Analog input 10		configurable	All
50152	50	5-6	int16	10180	External Analog input 11		configurable	All
50153	51	1-2	int16	10181	External Analog input 12		configurable	All
50154	51	3-4	int16	10182	External Analog input 13		configurable	All
50155	51	5-6	int16	10183	External Analog input 14		configurable	All
50156	52	1-2	int16	10184	External Analog input 15		configurable	All
50157	52	3-4	int16	10185	External Analog input 16		configurable	All
50158	52	5-6	int16	10245	External Analog Output 1	%	*100	All
50159	53	1-2	int16	10255	External Analog Output 2	%	*100	All
50160	53	3-4	int16	10265	External Analog Output 3	%	*100	All
50161	53	5-6	int16	10275	External Analog Output 4	%	*100	All
50162	54	1-2			Internal			
50163	54	3-6	uint32	2580	Period of use counter	h	*100	All
50165	55	1-2	int16	4093	BITLIST			
					08.34 GGB fail to close latched		Mask: 8000h	EG3500XT-P1 EG3500XT-P2
					08.35 GGB fail to open latched		Mask: 4000h	EG3500XT-P1 EG3500XT-P2
					08.27 Missing EG3000		Mask: 2000h	All
					08.28 Missing LS5		Mask: 1000h	EG3500XT-P1 EG3500XT-P2

9.2.6 Protocol 5014 (Based on Protocol 5003 but with enhancements)

Modbus-Address	CAN Mux	CAN Byte	Size	Index	Description	Unit	Scale	Model
					05.18 Cylinder temperature level 1		Mask: 0800h	All
					05.19 Cylinder temperature level 2		Mask: 0400h	All
					05.20 Cylinder temperature wire break		Mask: 0200h	All
					Internal		Mask: 0100h	
					08.44 Syst.update LS5		Mask: 0080h	EG3500XT-P1 EG3500XT-P2
					08.43 Syst.update easYgen		Mask: 0040h	All
					06.32 Gen.AC Wiring		Mask: 0020h	All
					06.33 Busbar1 AC Wiring		Mask: 0010h	EG3500XT-P2
					Internal		Mask: 0008h	
					Internal		Mask: 0004h	
					Internal		Mask: 0002h	
					Load share diagnostic: Own Unit is suspected		Mask: 0001h	All
50166	55	3-6	uint32	219	Nominal active power in system (in own segment)		*1	All
50168	56	1-2	int16	4157	BITLIST			
					28.01 Command 1 to LS5 (OR)		Mask: 8000h	EG3500XT-P1 EG3500XT-P2
					28.02 Command 2 to LS5 (OR)		Mask: 4000h	EG3500XT-P1 EG3500XT-P2
					28.03 Command 3 to LS5 (OR)		Mask: 2000h	EG3500XT-P1 EG3500XT-P2
					28.04 Command 4 to LS5 (OR)		Mask: 1000h	EG3500XT-P1 EG3500XT-P2
					28.05 Command 5 to LS5 (OR)		Mask: 0800h	EG3500XT-P1 EG3500XT-P2
					28.06 Command 6 to LS5 (OR)		Mask: 0400h	EG3500XT-P1 EG3500XT-P2

9 Appendix

9.2.6 Protocol 5014 (Based on Protocol 5003 but with enhancements)

Modbus-Address	CAN Mux	CAN Byte	Size	Index	Description	Unit	Scale	Model
					Gen excitation limit active		Mask: 0200h	EG3500XT-P1 EG3500XT-P2
					03.39 Neutral interlocking - Closed NC		Mask: 0100h	All
					05.17 Uprating active		Mask: 0080h	
					Internal		Mask: 0040h	
					Internal		Mask: 0020h	
					Internal		Mask: 0010h	
					Internal		Mask: 0008h	
					Internal		Mask: 0004h	
					Internal		Mask: 0002h	
					03.38 Inhibit cranking		Mask: 0001h	All
50169	56	3-6	int32	218	Active real power in system (in own segment)	kW	*1	All
50171	57	1-2			Internal			
50172	57	3-6	int32	217	Active power reserve in system (in own segment)	kW	*1	All
50174	58	1-2			Internal			
50175	58	3-4	int16	239	System actual nominal power	%	*100	All
50176	58	5-6	int16	240	System total real power	%	*100	All
50177	59	1-2			Internal			
50178	59	3-4	int16	241	System reserve active power	%	*100	All
50179	59	5-6	int16	15311	Engine Derate Request	%	*1	All
50180	60	1-2			Internal			
50181	60	3-4			Internal			
50182	60	5-6			Internal			
50183	61	1-2	int16	2556	Days until next maintenance	d	*1	All
50184	61	3-6	int32	233	Busbar: Voltage L3-N	V	*1	EG3500XT-P1 EG3500XT-P2
50186	62	1-2	int16	4094	BITLIST			
					02.03 Generator voltage in range		Mask: 8000h	All
					02.06 Busbar voltage in range		Mask: 4000h	All
					02.11 Mains voltage and frequency in range		Mask: 2000h	All
					02.21 Busbar is dead		Mask: 1000h	All
					86.27 LM External mains decoupling		Mask: 0800h	All
					87.70 LM Release engine monitoring		Mask: 0400h	All

Modbus-Address	CAN Mux	CAN Byte	Size	Index	Description	Unit	Scale	Model
					87.72 LM Disable mains monitoring		Mask: 0200h	All
					87.73 LM Mains decoupling MCB		Mask: 0100h	All
					87.74 LM Inhibit dead bus GCB		Mask: 0080h	All
					86.41 LDSS IOP Reserve power 2 ready		Mask: 0040h	All
					XX.XX LDSS IOP Reserve power 3 ready		Mask: 0020h	
					XX.XX LDSS IOP Reserve power 4 ready		Mask: 0010h	
					86.42 LDSS MOP Reserve power 2 ready		Mask: 0008h	All
					XX.XX LDSS MOP Reserve power 3 ready		Mask: 0004h	
					XX.XX LDSS MOP Reserve power 4 ready		Mask: 0002h	
					02.45 Mains release breaker		Mask: 0001h	All
50187	62	3-6	int32	5642	Setpoint reactive power	kvar	*10	All
50189	63	1-2	int16	4095	BITLIST			
					96.32 LM Internal Flag 32		Mask: 8000h	All
					96.31 LM Internal Flag 31		Mask: 4000h	All
					96.30 LM Internal Flag 30		Mask: 2000h	All
					96.29 LM Internal Flag 29		Mask: 1000h	All
					96.28 LM Internal Flag 28		Mask: 0800h	All
					96.27 LM Internal Flag 27		Mask: 0400h	All
					96.26 LM Internal Flag 26		Mask: 0200h	All
					96.25 LM Internal Flag 25		Mask: 0100h	All
					96.24 LM Internal Flag 24		Mask: 0080h	All
					96.23 LM Internal Flag 23		Mask: 0040h	All
					96.22 LM Internal Flag 22		Mask: 0020h	All
					96.21 LM Internal Flag 21		Mask: 0010h	All
					96.20 LM Internal Flag 20		Mask: 0008h	All
					96.19 LM Internal Flag 19		Mask: 0004h	All
					96.18 LM Internal Flag 18		Mask: 0002h	All
					96.17 LM Internal Flag 17		Mask: 0001h	All
50190	63	3-4	uint16		BITLIST			
					Internal		Mask: F000h	
					Engine state number: 0,1 : internal 2: Off 3: Preglow 4: Crank 5: Run 6: Cool down		Mask: 0F00h	All

9 Appendix

9.2.6 Protocol 5014 (Based on Protocol 5003 but with enhancements)

Modbus-Address	CAN Mux	CAN Byte	Size	Index	Description	Unit	Scale	Model
					7: Spin down 8: Start pause 9: Idle 10: Run-up synchr. mode active 11: Run-up synchr. Wait on excitation			
					Reactive load control state number: 2: Static 3: Isochronous 4: Reactive load control 0, 1, 5, 6, 7, 8, 9, 10, 11, ... : internal		Mask: 00F0h	All
					Real load control state number: 2: Static 3: Isochronous 4: Base load control 5: Export/import control 0, 1, 6, 7, 8, 9, 10, 11, ... : internal		Mask: 000Fh	All
50191	63	5-6	int16	9642	Free AnalogManager Value 1			All
50192	64	1-2	int16	9646	Free AnalogManager Value 2			All
50193	64	3-4	int16	9650	Free AnalogManager Value 3			All
50194	64	5-6	int16	9654	Free AnalogManager Value 4			All
50195	65	1-2	int16	9658	Free AnalogManager Value 5			All
50196	65	3-4	int16	9662	Free AnalogManager Value 6			All
50197	65	5-6	int16	9666	Free AnalogManager Value 7			All
50198	66	1-2	int16	9670	Free AnalogManager Value 8			All
50199	66	3-4	int16	9674	Free AnalogManager Value 9			All
50200	66	5-6	int16	9678	Free AnalogManager Value 10			All
50201	67	1-2	int16	9682	Free AnalogManager Value 11			All
50202	67	3-4	int16	9686	Free AnalogManager Value 12			All
50203	67	5-6	int16	9690	Free AnalogManager Value 13			All
50204	68	1-2	int16	9694	Free AnalogManager Value 14			All
50205	68	3-6	int32	9698	Free AnalogManager Value 15 (long)			All
50207	69	1-2			Internal			
50208	69	3-6	int32	9702	Free AnalogManager Value 16 (long)			All
50210	70	1-2	int16	8908 8910	81.29 Engine Coolant Temperature (HMI)	°C °F	1	All

9.2.6 Protocol 5014 (Based on Protocol 5003 but with enhancements)

Modbus-Address	CAN Mux	CAN Byte	Size	Index	Description	Unit	Scale	Model
50211	70	3-4	int16	8904	81.25 Engine Oil Pressure (HMI)	bar	*1 bar	All
				[0.1bar]		psi	1 psi	
50212	70	5-6	int16	4096	BITLIST			
					Monitored Number of easYgen communicating		Mask: FF00h	All
					Number of easYgens currently communicating		Mask: 00FFh	All
50213	71	1-2	int16	4097	BITLIST			
					Monitored Number of LS5 communicating		Mask: FF00h	EG3500XT-P1 EG3500XT-P2
					Number of LS5 currently communicating		Mask: 00FFh	EG3500XT-P1 EG3500XT-P2
50214	71	3-4	int16	4098	BITLIST			
					Device number of missing LSx (33-48)		Mask FFFFh	EG3500XT-P1 EG3500XT-P2
					LSx Device Nr. 48		Mask 8000h	
					LSx Device Nr. 47		Mask 4000h	
					LSx Device Nr. 46		Mask 2000h	
					LSx Device Nr. 45		Mask 1000h	
					LSx Device Nr. 44		Mask 0800h	
					LSx Device Nr. 43		Mask 0400h	
					LSx Device Nr. 42		Mask 0200h	
					LSx Device Nr. 41		Mask 0100h	
					LSx Device Nr. 40		Mask 0080h	
					LSx Device Nr. 39		Mask 0040h	
					LSx Device Nr. 38		Mask 0020h	
					LSx Device Nr. 37		Mask 0010h	
					LSx Device Nr. 36		Mask 0008h	
					LSx Device Nr. 35		Mask 0004h	
					LSx Device Nr. 34		Mask 0002h	
LSx Device Nr. 33		Mask 0001h						
50215	71	5-6	int16	4099	BITLIST			
					Device number of missing LSx (49-64)		Mask FFFFh	EG3500XT-P1

9 Appendix

9.2.6 Protocol 5014 (Based on Protocol 5003 but with enhancements)

Modbus-Address	CAN Mux	CAN Byte	Size	Index	Description	Unit	Scale	Model
								EG3500XT-P2
					LSx Device Nr. 64		Mask 8000h	
					LSx Device Nr. 63		Mask 4000h	
					LSx Device Nr. 62		Mask 2000h	
					LSx Device Nr. 61		Mask 1000h	
					LSx Device Nr. 60		Mask 0800h	
					LSx Device Nr. 59		Mask 0400h	
					LSx Device Nr. 58		Mask 0200h	
					LSx Device Nr. 57		Mask 0100h	
					LSx Device Nr. 56		Mask 0080h	
					LSx Device Nr. 55		Mask 0040h	
					LSx Device Nr. 54		Mask 0020h	
					LSx Device Nr. 53		Mask 0010h	
					LSx Device Nr. 52		Mask 0008h	
					LSx Device Nr. 51		Mask 0004h	
					LSx Device Nr. 50		Mask 0002h	
					LSx Device Nr. 49		Mask 0001h	
50216	72	1-2	int16	10282	BITLIST			
					16.16 Free alarm 16 latched		Mask: 8000h	All
					16.15 Free alarm 15 latched		Mask: 4000h	All
					16.14 Free alarm 14 latched		Mask: 2000h	All
					16.13 Free alarm 13 latched		Mask: 1000h	All
					16.12 Free alarm 12 latched		Mask: 0800h	All
					16.11 Free alarm 11 latched		Mask: 0400h	All
					16.10 Free alarm 10 latched		Mask: 0200h	All
					16.09 Free alarm 9 latched		Mask: 0100h	All
					16.08 Free alarm 8 latched		Mask: 0080h	All
					16.07 Free alarm 7 latched		Mask: 0040h	All
					16.06 Free alarm 6 latched		Mask: 0020h	All
					16.05 Free alarm 5 latched		Mask: 0010h	All
					16.04 Free alarm 4 latched		Mask: 0008h	All
					16.03 Free alarm 3 latched		Mask: 0004h	All
					16.02 Free alarm 2 latched		Mask: 0002h	All
					16.01 Free alarm 1 latched		Mask: 0001h	All
50217	72	3-4	int16	10313	BITLIST			
					Internal		Mask: 8000h	
					Internal		Mask: 4000h	

Modbus-Address	CAN Mux	CAN Byte	Size	Index	Description	Unit	Scale	Model
					Internal		Mask: 2000h	
					06.36 Pole slip		Mask: 1000h	All
					07.33 FRT Time-dep. voltage 3		Mask: 0800h	All
					Internal		Mask: 0400h	
					Internal		Mask: 0200h	
					07.31 FRT Time-dep. voltage 2		Mask: 0100h	All
					Internal		Mask: 0080h	
					Internal		Mask: 0040h	
					Internal		Mask: 0020h	
					08.40 CAN J1939 device 3 timeout		Mask: 0010h	All
					08.39 CAN J1939 device 2 timeout		Mask: 0008h	All
					08.38 CAN J1939 device 1 timeout		Mask: 0004h	All
					08.37 CAN J1939 ECU timeout		Mask: 0002h	All
					08.29 CANopen error interface 3		Mask: 0001h	All
50218	72	5-6	int16		Internal			
50219	73	1-4	int32	2526	Generator negative reactive energy	Mvarh	*100	All
50221	73	5-6	int16		Internal			
50222	74	1-4	int32		05.70 Active power set point ramped	kW	*1	All
50224	74	5-6	int16		Internal			
50225	75	1-4	int32		05.92 Reactive power set point ramped	kvar	*1	All
50227	75	5-6	int16		Internal			
					75 Mux x 20ms = 1.5s refresh rate			

9.2.7 Protocol 5016 (Basic Visualization)

Modbus-Address	Size	Index	Description	Unit	Scale	Model
50000	int16		Protocol-ID, always 5016			
50001	int16	3181	Scaling Power (16 bits) Exponent 10x W (5;4;3;2)			All
50002	int16	3182	Scaling Volts (16 bits) Exponent 10x V (2;1;0;-1)			All
50003	int16	3183	Scaling Amps (16 bits) Exponent 10x A (0;-1)			All
50004	int16		Internal			
50005	int16		Internal			
50006	int16		Internal			
50007	int16		Internal			
Topic AC Generator and Busbar values						

9 Appendix

9.2.7 Protocol 5016 (Basic Visualization)

Modbus-Address	Size	Index	Description	Unit	Scale	Model
50008	int16	283	Busbar Voltage L3-N	V	format defined by index 3182 (Modbus-Address 50002)	EG3500XT-P2
50009	int16	144	Generator frequency	Hz	*100	All
50010	int16	246	Total generator power	W	format defined by index 3181 (Modbus-Address 50001)	All
50011	int16	247	Total generator reactive power	var	format defined by index 3181 (Modbus-Address 50001)	All
50012	int16	160	Generator power factor		*1000	All
50013	int16	248	Generator voltage L1-L2	V	format defined by index 3182 (Modbus-Address 50002)	All
50014	int16	249	Generator voltage L2-L3	V	format defined by index 3182 (Modbus-Address 50002)	All
50015	int16	250	Generator voltage L3-L1	V	format defined by index 3182 (Modbus-Address 50002)	All
50016	int16	251	Generator voltage L1-N	V	format defined by index 3182 (Modbus-Address 50002)	All
50017	int16	252	Generator voltage L2-N	V	format defined by index 3182 (Modbus-Address 50002)	All
50018	int16	253	Generator voltage L3-N	V	format defined by index 3182 (Modbus-Address 50002)	All
50019	int16	255	Generator current L1	A	format defined by index 3183 (Modbus-	All

Modbus-Address	Size	Index	Description	Unit	Scale	Model
					Address 50003)	
50020	int16	256	Generator current L2	A	format defined by index 3183 (Modbus-Address 50003)	All
50021	int16	257	Generator current L3	A	format defined by index 3183 (Modbus-Address 50003)	All
50022	int16	209	Busbar Frequency	Hz	*100	All
50023	int16	254	Busbar Voltage L1-L2	V	format defined by index 3182 (Modbus-Address 50002)	All
50024	int16	279	Busbar Voltage L2-L3	V	format defined by index 3182 (Modbus-Address 50002)	EG3500XT-P2
50025	int16	280	Busbar Voltage L3-L1	V	format defined by index 3182 (Modbus-Address 50002)	EG3500XT-P2
50026	int16	281	Busbar Voltage L1-N	V	format defined by index 3182 (Modbus-Address 50002)	EG3500XT-P2
50027	int16	282	Busbar Voltage L2-N	V	format defined by index 3182 (Modbus-Address 50002)	EG3500XT-P2
50028	int16	5541	Setpoint frequency Source (Index) may differ depending on MAN mode (5509) or breaker synchronisation.	Hz	*100	All
50029	int16	5641	Setpoint power factor (cosphi) Source (Index) may differ depending on MAN mode (5623).		*1000	All
Topic AC Mains values						
50030	int16	147	Mains frequency	Hz	*100	All
50031	int16	258	Total mains active power	W	format defined by index 3181 (Modbus-	All

9 Appendix

9.2.7 Protocol 5016 (Basic Visualization)

Modbus-Address	Size	Index	Description	Unit	Scale	Model
					Address 50001)	
50032	int16	259	Total mains reactive power	var	format defined by index 3181 (Modbus-Address 50001)	All
50033	int16	208	Mains power factor		*1000	All
50034	int16	260	Mains voltage L1-L2	V	format defined by index 3182 (Modbus-Address 50002)	All
50035	int16	261	Mains voltage L2-L3	V	format defined by index 3182 (Modbus-Address 50002)	All
50036	int16	262	Mains voltage L3-L1	V	format defined by index 3182 (Modbus-Address 50002)	All
50037	int16	263	Mains voltage L1-N	V	format defined by index 3182 (Modbus-Address 50002)	All
50038	int16	264	Mains voltage L2-N	V	format defined by index 3182 (Modbus-Address 50002)	All
50039	int16	265	Mains voltage L3-N	V	format defined by index 3182 (Modbus-Address 50002)	All
50040	int16	266	Mains current L1	A	format defined by index 3183 (Modbus-Address 50003)	All
50041	int16		Internal			
50042	int16		Internal			
50043	int16	267	Average LSx Delta Mains voltage L-L	V	format defined by index 3182 (Modbus-Address 50002)	EG3500XT-P1 EG3500XT-P1

Modbus-Address	Size	Index	Description	Unit	Scale	Model
50044	int16	268	Average LSx Wye Mains voltage L-N	V	format defined by index 3182 (Modbus-Address 50002)	EG3500XT-P1 EG3500XT-P2
Topic AC System values						
50045	uint16	239	Nominal real power in system	%	*100	All
50046	int16	240	Real power in system	%	*100	All
50047	int16	241	Reserve real power in system	%	*100	All
50048	int16	269	Active power LSx	W	format defined by index 3181 (Modbus-Address 50001)	EG3500XT-P1 EG3500XT-P2
50049	int16	270	Reactive power LSx	var	format defined by index 3181 (Modbus-Address 50001)	EG3500XT-P1 EG3500XT-P2
50050	int16	4608	Average LSx Mains delta frequency L-L	Hz	*100	EG3500XT-P1 EG3500XT-P2
Topic DC Analogue Values (Engine Values)						
50051	int16	10100	Engine Pickup speed	rpm	*1	All
50052	int16	10110	Battery voltage	V	*10	All
50053	int16	10159	AI Auxiliary excitation D+	V	*10	All
50054	uint16	2540	Engine, number of start requests		*1	All
50055	int16	2558	Hours until next maintenance	h	*1	All
50056	int16	10111	Analog input 1		configurable	All
50057	int16	10112	Analog input 2		configurable	All
50058	int16	10115	Analog input 3		configurable	All
50059	int16	10117	Analog input 4		configurable	EG3500XT-P2
50060	int16	10151	Analog input 5		configurable	EG3500XT-P2
50061	int16	10152	Analog input 6		configurable	EG3500XT-P2
50062	int16	10153	Analog input 7		configurable	EG3500XT-P2
50063	int16	10154	Analog input 8		configurable	EG3500XT-P2
50064	int16	10155	Analog input 9		configurable	EG3500XT-P2
50065	int16	10156	Analog input 10		configurable	EG3500XT-P2
50066	int16		Internal			
50067	int16		Internal			
50068	int16	10310	Analog output 1	%	*100	All
50069	int16	10311	Analog output 2	%	*100	All

9 Appendix

9.2.7 Protocol 5016 (Basic Visualization)

Modbus-Address	Size	Index	Description	Unit	Scale	Model
50070	int16	10317	Analog output 3	%	*100	EG3500XT-P2
50071	int16	10318	Analog output 4	%	*100	EG3500XT-P2
50072	int16	10319	Analog output 5	%	*100	EG3500XT-P2
50073	int16	10320	Analog output 6	%	*100	EG3500XT-P2
50074	int16	10170	External Analog input 1		configurable	All
50075	int16	10171	External Analog input 2		configurable	All
50076	int16	10172	External Analog input 3		configurable	All
50077	int16	10173	External Analog input 4		configurable	All
50078	int16	10174	External Analog input 5		configurable	All
50079	int16	10175	External Analog input 6		configurable	All
50080	int16	10176	External Analog input 7		configurable	All
50081	int16	10177	External Analog input 8		configurable	All
50082	int16	10178	External Analog input 9		configurable	All
50083	int16	10179	External Analog input 10		configurable	All
50084	int16	10180	External Analog input 11		configurable	All
50085	int16	10181	External Analog input 12		configurable	All
50086	int16	10182	External Analog input 13		configurable	All
50087	int16	10183	External Analog input 14		configurable	All
50088	int16	10184	External Analog input 15		configurable	All
50089	int16	10185	External Analog input 16		configurable	All
50090	int16	10245	External Analog Output 1	%	*100	All
50091	int16	10255	External Analog Output 2	%	*100	All
50092	int16	10265	External Analog Output 3	%	*100	All
50093	int16	10275	External Analog Output 4	%	*100	All
50094	int16	2556	Days until next maintenance	days	*1	All
50095	int16		Internal			
50096	int16	15397	Engine Coolant Temperature (HMI Analogmanager 8901)	°C °F	*1	All
50097	int16	15319	Engine Oil Pressure (HMI Analogmanager 8893)	bar psi	*10 bar *1 psi	All
50098	int16		Internal			
Topic Control and Status						
50099	uint16	10698	BITGROUP Control mode (STOP/AUTO/ MANUAL/TEST) 1=AUTO - 04.01 Operation Mode Auto 2=STOP - 04.02 Operation Mode Stop 4=MANUAL - 04.03 Operation Mode Man		Mask: 000Fh	All

Modbus-Address	Size	Index	Description	Unit	Scale	Model
			8=TEST - 04.03 Operation Mode Test			
50100	int16	10202	Status message. This is an index number. Refer to manual chapter Status messages for more information.		*1	All
50101	int16		Internal			
50102	uint16	4153	BITLIST ControlBits1			
			Idle mode OR Ramp to rated active		Mask: 8000h	All
			04.15 Idle run is active		Mask: 4000h	All
			04.12 Start without closing GCB		Mask: 2000h	All
			04.64 Key activation		Mask: 1000h	All
			A manual START has been requested		Mask: 0800h	All
			A manual STOP has been requested		Mask: 0400h	All
			04.10 Cooldown is active		Mask: 0200h	All
			03.01 Auxiliary Services is active		Mask: 0100h	All
			03.07 Engine monitoring delay expired		Mask: 0080h	All
			03.08 Breaker delay timer has expired		Mask: 0040h	All
			03.25 Engine shall run		Mask: 0020h	All
			04.27 Critical mode is active		Mask: 0010h	All
			03.06 Engine release is active		Mask: 0008h	All
			03.30 Auxiliary services prerun is active		Mask: 0004h	All
			03.31 Auxiliary services postrun is active		Mask: 0002h	All
			04.61 Lamp test request		Mask: 0001h	All
50103	uint16	4154	BITLIST ControlBits2			
			03.02 Starter / Crank is active		Mask: 8000h	All
			03.28 Operating Magnet / Gasrelay is active		Mask: 4000h	All
			03.04 Preglow or Ignition is active		Mask: 2000h	All
			04.11 Mains settling		Mask: 1000h	All
			04.09 Emergency mode is currently active		Mask: 0800h	All
			03.40 Remote Shutdown (ID503, Bit9)		Mask: 0400h	All
			03.33 Free PID Controller 3: Lower Command		Mask: 0200h	All
			03.32 Free PID Controller 3: Raise Command		Mask: 0100h	All
			03.35 Free PID Controller 2: Lower Command		Mask: 0080h	All
			03.34 Free PID Controller 2: Raise Command		Mask: 0040h	All
			03.27 Stop solenoid is active		Mask: 0020h	All
			03.24 Excitation enabled (Run-up Synchronization)		Mask: 0010h	EG3500XT-P1 EG3500XT-P2
			The genset runs mains parallel		Mask: 0008h	All
			03.37 Free PID Controller 1: Lower Command		Mask: 0004h	All

Modbus-Address	Size	Index	Description	Unit	Scale	Model
			03.36 Free PID Controller 1: Raise Command		Mask: 0002h	All
			Increment Engine Start Counter		Mask: 0001h	All
50104	uint16	4155	BITLIST ControlBits3			
			03.20 3-Pos. Controller Freq./Power raise		Mask: 8000h	All
			03.21 3-Pos. Controller Freq./Power lower		Mask: 4000h	All
			03.22 3-Pos. Controller Volt./ReactPow raise		Mask: 2000h	All
			03.23 3-Pos. Controller Volt./ReactPow lower		Mask: 1000h	All
			04.06 GCB is closed		Mask: 0800h	All
			04.07 MCB is closed		Mask: 0400h	All
			05.16 Derating active (J1939 or freely)		Mask: 0200h	All
			04.18 Synchronisation GCB procedure is active		Mask: 0100h	All
			04.19 Opening GCB relay is active		Mask: 0080h	All
			04.20 Close command GCB is active		Mask: 0040h	All
			04.21 Synchronisation MCB procedure is active		Mask: 0020h	All
			04.22 Open command MCB is active		Mask: 0010h	All
			04.23 Close command MCB is active		Mask: 0008h	All
			04.28 Unloading generator is active		Mask: 0004h	All
			04.29 Unloading mains is active		Mask: 0002h	All
			04.30 Power limited prerun		Mask: 0001h	All
50105	uint16	4156	BITLIST ControlBits4			
			04.16 GGB is closed		Mask: 8000h	EG3500XT-P1 EG3500XT-P2
			04.17 GGB is released		Mask: 4000h	EG3500XT-P1 EG3500XT-P2
			04.24 Synchronisation GGB procedure is active		Mask: 2000h	EG3500XT-P1 EG3500XT-P2
			04.25 Open command GGB is active		Mask: 1000h	EG3500XT-P1 EG3500XT-P2
			04.26 Close command GGB is active		Mask: 0800h	EG3500XT-P1 EG3500XT-P2
			Dead busbar closure requ. for GCB,MCB or GGB		Mask: 0400h	All
			4.62 Active power load share is active		Mask: 0200h	All
			4.63 Reactive power load share is active		Mask: 0100h	All
			Generator with a closed GCB is requested		Mask: 0080h	All
			LDSS: The Engine shall start		Mask: 0040h	All

Modbus-Address	Size	Index	Description	Unit	Scale	Model
			LDSS: The Engine shall stop		Mask: 0020h	All
			LDSS: The Engine shall stop, if possible		Mask: 0010h	All
			LDSS: Minimum Running Time is active		Mask: 0008h	All
			04.43 The LDSS function is active		Mask: 0004h	All
			04.60 Critical mode postrun		Mask: 0002h	All
			AUTOMATIC Run: Switch to Operating Mode STOP		Mask: 0001h	All
50106	uint16	4150	BITLIST ControlBits5			
			04.13 Remote Start request		Mask: 8000h	All
			04.14 Remote acknowledge		Mask: 4000h	All
			05.17 Uprating active		Mask: 2000h	All
			86.25 LM Frequency Droop active		Mask: 1000h	All
			86.26 LM Voltage Droop active		Mask: 0800h	All
			Synchronization mode Check active		Mask: 0400h	All
			Synchronization mode Permissive active		Mask: 0200h	All
			Synchronization mode Run active		Mask: 0100h	All
			86.85 LM Enable MCB		Mask: 0080h	All
			86.41 LDSS IOP Reserve power 2 ready		Mask: 0040h	All
			86.42 LDSS MOP Reserve power 2 ready		Mask: 0020h	All
			02.39 Mains decoupling enabled		Mask: 0010h	All
			04.70 Opening GCB active		Mask: 0008h	All
			Parameter set 1-7 selection Bit 3		Mask: 0004h	Rental
			Parameter set 1-7 selection Bit 2		Mask: 0002h	Rental
			Parameter set 1-7 selection Bit 1		Mask: 0001h	Rental
50107	uint16	4084	BITLIST ControlBits 21			
			02.03 Generator voltage in range		Mask: 8000h	All
			02.06 Busbar voltage in range		Mask: 4000h	All
			02.11 Mains voltage and frequency in range		Mask: 2000h	All
			02.21 Busbar is dead		Mask: 1000h	All
			86.27 LM Mains failure by external device		Mask: 0800h	All
			87.70 LM Release engine monitoring		Mask: 0400h	All
			87.72 LM Disable mains monitoring		Mask: 0200h	All
			87.73 LM Mains decoupling MCB		Mask: 0100h	All
			87.74 LM Inhibit dead bus GCB		Mask: 0080h	All
			Load share diagnostic: Own Unit is suspected		Mask: 0040h	All
			02.45 Mains release breaker		Mask: 0020h	All
			Internal		Mask: 0010h	
			Internal		Mask: 0008h	

Modbus-Address	Size	Index	Description	Unit	Scale	Model
			Internal		Mask: 0004h	
			Internal		Mask: 0002h	
			Internal		Mask: 0001h	
Topic Discrete Outputs						
50108	uint16	10107	BITLIST Relay Outputs 1			
			13.01 Relay-Output 1 (Self-test-relay)		Mask: 8000h	All
			13.02 Relay-Output 2		Mask: 4000h	All
			13.03 Relay-Output 3		Mask: 2000h	All
			13.04 Relay-Output 4		Mask: 1000h	All
			13.05 Relay-Output 5		Mask: 0800h	All
			13.06 Relay-Output 6		Mask: 0400h	All
			13.07 Relay-Output 7		Mask: 0200h	All
			13.08 Relay-Output 8		Mask: 0100h	All
			13.09 Relay-Output 9		Mask: 0080h	All
			13.10 Relay-Output 10		Mask: 0040h	All
			13.11 Relay-Output 11		Mask: 0020h	All
			13.12 Relay-Output 12		Mask: 0010h	All
			Internal		Mask: 0008h	All
			Internal		Mask: 0004h	All
			Internal		Mask: 0002h	All
			Internal		Mask: 0001h	All
50109	uint16	10109	BITLIST Relay Outputs 2			
			13.13 Relay-Output 13		Mask: 8000h	EG3500XT-P2
			13.14 Relay-Output 14		Mask: 4000h	EG3500XT-P2
			13.15 Relay-Output 15		Mask: 2000h	EG3500XT-P2
			13.16 Relay-Output 16		Mask: 1000h	EG3500XT-P2
			13.17 Relay-Output 17		Mask: 0800h	EG3500XT-P2
			13.18 Relay-Output 18		Mask: 0400h	EG3500XT-P2
			13.19 Relay-Output 19		Mask: 0200h	EG3500XT-P2
			13.20 Relay-Output 20		Mask: 0100h	EG3500XT-P2
			13.21 Relay-Output 21		Mask: 0080h	EG3500XT-P2
			13.22 Relay-Output 22		Mask: 0040h	EG3500XT-P2
			Internal		Mask: 0020h	All
			Internal		Mask: 0010h	All
			Internal		Mask: 0008h	All
			Internal		Mask: 0004h	All
			13.34 Transistor output 2		Mask: 0002h	EG3500XT-P2

Modbus-Address	Size	Index	Description	Unit	Scale	Model
			13.33 Transistor output 1		Mask: 0001h	EG3500XT-P2
50110	uint16	8005	BITLIST Relay Outputs 3			
			98.16 LM External DO 16		Mask: 8000h	All
			98.15 LM External DO 15		Mask: 4000h	All
			98.14 LM External DO 14		Mask: 2000h	All
			98.13 LM External DO 13		Mask: 1000h	All
			98.12 LM External DO 12		Mask: 0800h	All
			98.11 LM External DO 11		Mask: 0400h	All
			98.10 LM External DO 10		Mask: 0200h	All
			98.09 LM External DO 9		Mask: 0100h	All
			98.08 LM External DO 8		Mask: 0080h	All
			98.07 LM External DO 7		Mask: 0040h	All
			98.06 LM External DO 6		Mask: 0020h	All
			98.05 LM External DO 5		Mask: 0010h	All
			98.04 LM External DO 4		Mask: 0008h	All
			98.03 LM External DO 3		Mask: 0004h	All
			98.02 LM External DO 2		Mask: 0002h	All
			98.01 LM External DO 1		Mask: 0001h	All
50111	uint16	8009	BITLIST Relay Outputs 4			
			98.32 LM External DO 32		Mask: 8000h	All
			98.31 LM External DO 31		Mask: 4000h	All
			98.30 LM External DO 30		Mask: 2000h	All
			98.29 LM External DO 29		Mask: 1000h	All
			98.28 LM External DO 28		Mask: 0800h	All
			98.27 LM External DO 27		Mask: 0400h	All
			98.26 LM External DO 26		Mask: 0200h	All
			98.25 LM External DO 25		Mask: 0100h	All
			98.24 LM External DO 24		Mask: 0080h	All
			98.23 LM External DO 23		Mask: 0040h	All
			98.22 LM External DO 22		Mask: 0020h	All
			98.21 LM External DO 21		Mask: 0010h	All
			98.20 LM External DO 20		Mask: 0008h	All
			98.19 LM External DO 19		Mask: 0004h	All
			98.18 LM External DO 18		Mask: 0002h	All
			98.17 LM External DO 17		Mask: 0001h	All
50112	uint16	4157	BITLIST ControlBits6			
			28.01 Command 1 to LSx (OR)		Mask: 8000h	EG3500XT-P1

Modbus-Address	Size	Index	Description	Unit	Scale	Model
						EG3500XT-P2
			28.02 Command 2 to LSx (OR)		Mask: 4000h	EG3500XT-P1 EG3500XT-P2
			28.03 Command 3 to LSx (OR)		Mask: 2000h	EG3500XT-P1 EG3500XT-P2
			28.04 Command 4 to LSx (OR)		Mask: 1000h	EG3500XT-P1 EG3500XT-P2
			28.05 Command 5 to LSx (OR)		Mask: 0800h	EG3500XT-P1 EG3500XT-P2
			28.06 Command 6 to LSx (OR)		Mask: 0400h	EG3500XT-P1 EG3500XT-P2
			02.38 Gen excitation limit active		Mask: 0200h	All
			03.39 Neutral interlocking - Closed NC		Mask: 0100h	All
			05.17 Uprating active		Mask: 0080h	All
			Extended Busbar F okay		Mask: 0040h	Marine
			Extended Busbar V okay		Mask: 0020h	Marine
			Extended Busbar F/V okay		Mask: 0010h	Marine
			Extended Busbar is dead		Mask: 0008h	Marine
			Phaseangle MNS/BUS okay		Mask: 0004h	Marine
			Phaseangle GEN/BUS okay		Mask: 0002h	Marine
			03.38 Inhibit cranking		Mask: 0001h	All
50113	int16		Internal			
Topic Alarm Management						
Subtopic General						
50114	uint16	10131	BITLIST Alarm General			
			01.11 New Alarm triggered		Mask: 8000h	All
			Internal		Mask: 4000h	
			Internal		Mask: 2000h	
			Internal		Mask: 1000h	
			Internal		Mask: 0800h	
			Internal		Mask: 0400h	
			Internal		Mask: 0200h	
			Internal		Mask: 0100h	
			Internal		Mask: 0080h	
			Internal		Mask: 0040h	
			01.06 Alarm class F latched		Mask: 0020h	All

Modbus-Address	Size	Index	Description	Unit	Scale	Model
			01.05 Alarm class E latched		Mask: 0010h	All
			01.04 Alarm class D latched		Mask: 0008h	All
			01.03 Alarm class C latched		Mask: 0004h	All
			01.02 Alarm class B latched		Mask: 0002h	All
			01.01 Alarm class A latched		Mask: 0001h	All
50115	uint16	10149	BITLIST Alarms 2 latched (unacknowledged)			
			08.30 Timeout Synchronisation GCB latched		Mask: 8000h	All
			08.31 Timeout Synchronisation MCB latched		Mask: 4000h	All
			08.32 Timeout Synchronisation GGB latched		Mask: 2000h	EG3500XT-P1 EG3500XT-P2
			05.11 Charge fail (D+ functionality) latched		Mask: 1000h	All
			Operating range failure 12 latched		Mask: 0800h	All
			08.45 CPU overload R1 trip latched		Mask: 0400h	All
			08.47 MCB failure 50BF		Mask: 0200h	All
			08.46 GCB failure 50BF		Mask: 0100h	All
			05.22 ECU Protect alarm		Mask: 0080h	All
			05.23 ECU Emission alarm		Mask: 0040h	All
			08.19 CANopen error at CAN Interface 2		Mask: 0020h	All
			08.16 Parameter Alignment LDSS		Mask: 0010h	All
			08.17 Missing members		Mask: 0008h	All
			08.48 MCB plausibility		Mask: 0004h	All
			05.13 ECU red lamp alarm latched		Mask: 0002h	All
			05.14 ECU yellow (amber) lamp alarm latched		Mask: 0001h	All
50116	uint16	4169	BITLIST Alarms 2 active			
			Timeout Synchronisation GCB		Mask: 8000h	All
			Timeout Synchronisation MCB		Mask: 4000h	All
			Timeout Synchronisation GGB		Mask: 2000h	EG3500XT-P1 EG3500XT-P2
			Charge fail (D+ functionality)		Mask: 1000h	All
			Gen/Busbar/Mains phase rotat.		Mask: 0800h	EG3500XT-P1 EG3500XT-P2
			CPU overload R1 trip		Mask: 0400h	All
			MCB failure 50BF		Mask: 0200h	All
			GCB failure 50BF		Mask: 0100h	All
			ECU Protect alarm		Mask: 0080h	All
			ECU Emission alarm		Mask: 0040h	All

9 Appendix

9.2.7 Protocol 5016 (Basic Visualization)

Modbus-Address	Size	Index	Description	Unit	Scale	Model
			CANopen error at CAN Interface 2		Mask: 0020h	All
			Parameter Alignment LDSS		Mask: 0010h	All
			Missing members		Mask: 0008h	All
			MCB plausibility		Mask: 0004h	All
			ECU red lamp alarm		Mask: 0002h	All
			ECU yellow (amber) lamp alarm		Mask: 0001h	All
50117	uint16	10190	BITLIST Alarms 3 latched (unacknowledged)			
			08.34 GGB fail to close latched		Mask: 8000h	EG3500XT-P1 EG3500XT-P2
			08.35 GGB fail to open latched		Mask: 4000h	EG3500XT-P1 EG3500XT-P2
			08.27 Missing easYgen		Mask: 2000h	All
			08.28 Missing LS5		Mask: 1000h	EG3500XT-P1 EG3500XT-P2
			05.18 Cylinder temperature level 1		Mask: 0800h	All
			05.19 Cylinder temperature level 2		Mask: 0400h	All
			05.20 Cylinder temperature wire break		Mask: 0200h	All
			6.35 Pole slip		Mask: 0100h	All
			08.44 Syst.update LS5		Mask: 0080h	EG3500XT-P1 EG3500XT-P2
			08.43 Syst.update easYgen		Mask: 0040h	All
			06.32 Gen.AC Wiring		Mask: 0020h	All
			06.33 Busbar1 AC Wiring		Mask: 0010h	EG3500XT-P2
			08.29 CANopen error interface 3		Mask: 0008h	EG3500XT-P1 EG3500XT-P2
			Internal		Mask: 0004h	
			Internal		Mask: 0002h	
			Internal		Mask: 0001h	
50118	uint16	4193	BITLIST Alarms 3 active			
			GGB fail to close		Mask: 8000h	EG3500XT-P1 EG3500XT-P2
			GGB fail to open		Mask: 4000h	EG3500XT-P1 EG3500XT-P2
			Missing easYgen		Mask: 2000h	All
			Missing LS5		Mask: 1000h	EG3500XT-P1

Modbus-Address	Size	Index	Description	Unit	Scale	Model
						EG3500XT-P2
			Temperature deviation level 1		Mask: 0800h	All
			Temperature deviation level 2		Mask: 0400h	All
			Temperature deviation wire break		Mask: 0200h	All
			Pole slip		Mask: 0100h	
			Syst.update LS5		Mask: 0080h	EG3500XT-P1 EG3500XT-P2
			Syst.update easYgen		Mask: 0040h	All
			Gen.AC Wiring		Mask: 0020h	All
			Busbar1 AC Wiring		Mask: 0010h	EG3500XT-P1 EG3500XT-P2
			CANopen error interface 3		Mask: 0008h	EG3500XT-P1 EG3500XT-P2
			Internal		Mask: 0004h	
			Internal		Mask: 0002h	
			Internal		Mask: 0001h	
50119	uint16	4086	BITGROUP ControlBits8			
		8809	Operating Range Monitoring Code Number		Mask: FF00h	All
		8818	The current segment number		Mask: 00FFh	All
Subtopic Engine						
50120	uint16	10133	BITLIST Alarms 1 latched (unacknowledged)			
			05.01 Engine Over speed 1 latched		Mask: 8000h	All
			05.02 Engine Over speed 2 latched		Mask: 4000h	All
			05.03 Engine under speed 1 latched		Mask: 2000h	All
			05.04 Engine under speed 2 latched		Mask: 1000h	All
			05.05 Unintended stop detected latched		Mask: 0800h	All
			05.07 Speed detection alarm latched		Mask: 0400h	All
			05.06 Shutdown malfunction detected latched		Mask: 0200h	All
			08.05 GCB fail to close latched		Mask: 0100h	All
			08.06 GCB fail to open latched		Mask: 0080h	All
			08.07 MCB fail to close latched		Mask: 0040h	All
			08.08 MCB fail to open latched		Mask: 0020h	All
			08.10 General CAN-J1939 fault latched		Mask: 0010h	All
			05.08 Start fail detected latched		Mask: 0008h	All
			05.09 Maintenance days exceeded latched		Mask: 0004h	All
			05.10 Maintenance hours exceeded latched		Mask: 0002h	All

Modbus-Address	Size	Index	Description	Unit	Scale	Model
			08.18 CANopen error at CAN Interface 1		Mask: 0001h	All
50121	uint16	4167	BITLIST Alarms 1 active			
			Engine Over speed 1		Mask: 8000h	All
			Engine Over speed 2		Mask: 4000h	All
			Engine under speed 1		Mask: 2000h	All
			Engine under speed 2		Mask: 1000h	All
			Unintended stop detected		Mask: 0800h	All
			Speed detection alarm		Mask: 0400h	All
			Shutdown malfunction detected		Mask: 0200h	All
			GCB fail to close		Mask: 0100h	All
			GCB fail to open		Mask: 0080h	All
			MCB fail to close		Mask: 0040h	All
			MCB fail to open		Mask: 0020h	All
			General CAN-J1939 fault		Mask: 0010h	All
			Start fail detected		Mask: 0008h	All
			Maintenance days exceeded		Mask: 0004h	All
			Maintenance hours exceeded		Mask: 0002h	All
			CANopen error at CAN Interface 1		Mask: 0001h	All
50122	uint16	10136	BITLIST Alarms AI 1 latched (unacknowledged)			
			Internal		Mask: 8000h	
			Internal		Mask: 4000h	
			Internal		Mask: 2000h	
			Internal		Mask: 1000h	
			Internal		Mask: 0800h	
			Internal		Mask: 0400h	
			Internal		Mask: 0200h	
			Internal		Mask: 0100h	
			Internal		Mask: 0080h	
			Internal		Mask: 0040h	
			Internal		Mask: 0020h	
			05.11 Failure Charging Alternator (D+)		Mask: 0010h	All
			08.02 Battery over voltage 2 latched		Mask: 0008h	All
			08.04 Battery under voltage 2 latched		Mask: 0004h	All
			08.01 Battery over voltage 1 latched		Mask: 0002h	All
			08.03 Battery under voltage 1 latched		Mask: 0001h	All
50123	uint16	4171	BITLIST Alarms Analog Inputs 1 active			
			Internal		Mask: 8000h	

Modbus-Address	Size	Index	Description	Unit	Scale	Model
			Internal		Mask: 4000h	
			Internal		Mask: 2000h	
			Internal		Mask: 1000h	
			Internal		Mask: 0800h	
			Internal		Mask: 0400h	
			Internal		Mask: 0200h	
			Internal		Mask: 0100h	
			Internal		Mask: 0080h	
			Internal		Mask: 0040h	
			Internal		Mask: 0020h	
			Failure Charging Alternator (D+)		Mask: 0010h	All
			Battery over voltage 2		Mask: 0008h	All
			Battery under voltage 2		Mask: 0004h	All
			Battery over voltage 1		Mask: 0002h	All
			Battery under voltage 1		Mask: 0001h	All
50124	int16		Internal			
50125	int16		Internal			
Subtopic Generator						
50126	uint16	10134	BITLIST Alarms Gen latched (unacknowledged)			
			06.01 Generator over frequency 1 latched		Mask: 8000h	All
			06.02 Generator over frequency 2 latched		Mask: 4000h	All
			06.03 Generator under frequency 1 latched		Mask: 2000h	All
			06.04 Generator under frequency 2 latched		Mask: 1000h	All
			06.05 Generator over voltage 1 latched		Mask: 0800h	All
			06.06 Generator over voltage 2 latched		Mask: 0400h	All
			06.07 Generator under voltage 1 latched		Mask: 0200h	All
			06.08 Generator under voltage 2 latched		Mask: 0100h	All
			06.09 Generator over current 1 latched		Mask: 0080h	All
			06.10 Generator over current 2 latched		Mask: 0040h	All
			06.11 Generator over current 3 latched		Mask: 0020h	All
			06.12 Reverse / reduced power 1 latched		Mask: 0010h	All
			06.13 Reverse / reduced power 2 latched		Mask: 0008h	All
			06.14 Generator overload IOP 1 latched		Mask: 0004h	All
			06.15 Generator overload IOP 2 latched		Mask: 0002h	All
			06.34 Busbar phase rotation mismatch latched		Mask: 0001h	EG3500XT-P2
50127	uint16	4161	BITLIST Alarms Generator active			
			Generator over frequency 1		Mask: 8000h	All

Modbus-Address	Size	Index	Description	Unit	Scale	Model
			Generator over frequency 2		Mask: 4000h	All
			Generator under frequency 1		Mask: 2000h	All
			Generator under frequency 2		Mask: 1000h	All
			Generator over voltage 1		Mask: 0800h	All
			Generator over voltage 2		Mask: 0400h	All
			Generator under voltage 1		Mask: 0200h	All
			Generator under voltage 2		Mask: 0100h	All
			Generator over current 1		Mask: 0080h	All
			Generator over current 2		Mask: 0040h	All
			Generator over current 3		Mask: 0020h	All
			Reverse / reduced power 1		Mask: 0010h	All
			Reverse / reduced power 2		Mask: 0008h	All
			Generator overload IOP 1		Mask: 0004h	All
			Generator overload IOP 2		Mask: 0002h	All
			Busbar phase rotation mismatch		Mask: 0001h	
50128	uint16	10138	BITLIST Alarms Gen 1 latched (unacknowledged)			
			06.16 Generator unbalanced load 1 latched		Mask: 8000h	All
			06.17 Generator unbalanced load 2 latched		Mask: 4000h	All
			06.18 Generator voltage asymmetry latched		Mask: 2000h	All
			06.19 Ground fault 1 latched		Mask: 1000h	All
			06.20 Ground fault 2 latched		Mask: 0800h	All
			06.21 Gen. Phase Rotation mismatch Latched		Mask: 0400h	All
			06.29 Gen. active power mismatch Latched		Mask: 0200h	All
			06.30 Generator unloading mismatch Latched		Mask: 0100h	All
			06.22 Inverse time over current Latched		Mask: 0080h	All
			06.31 Operating Range failed latched		Mask: 0040h	All
			06.23 Generator overload MOP 1 latched		Mask: 0020h	All
			06.24 Generator overload MOP 2 latched		Mask: 0010h	All
			06.25 Gen.Power Factor lagging 1 latched		Mask: 0008h	All
			06.26 Gen.Power Factor lagging 2 latched		Mask: 0004h	All
			06.27 Gen.Power Factor leading 1 latched		Mask: 0002h	All
			06.28 Gen.Power Factor leading 2 latched		Mask: 0001h	All
50129	uint16	4163	BITLIST Alarms Generator 1 active			
			Generator unbalanced load 1		Mask: 8000h	All
			Generator unbalanced load 2		Mask: 4000h	All
			Generator voltage asymmetry		Mask: 2000h	All
			Ground fault 1		Mask: 1000h	All

Modbus-Address	Size	Index	Description	Unit	Scale	Model
			Ground fault 2		Mask: 0800h	All
			Gen. Phase Rotation mismatch		Mask: 0400h	All
			Gen. active power mismatch		Mask: 0200h	All
			Generator unloading mismatch		Mask: 0100h	All
			Inverse time over current		Mask: 0080h	All
			Operating Range failed		Mask: 0040h	All
			Generator overload MOP 1		Mask: 0020h	All
			Generator overload MOP 2		Mask: 0010h	All
			Gen.Power Factor lagging 1		Mask: 0008h	All
			Gen.Power Factor lagging 2		Mask: 0004h	All
			Gen.Power Factor leading 1		Mask: 0002h	All
			Gen.Power Factor leading 2		Mask: 0001h	All
50130	int16		Internal			
50131	int16		Internal			
Subtopic Mains						
50132	uint16	10135	BITLIST Alarms Mains latched (unacknowledged)			
			07.06 Mains over frequency 1 latched		Mask: 8000h	All
			07.07 Mains over frequency 2 latched		Mask: 4000h	All
			07.08 Mains under frequency 1 latched		Mask: 2000h	All
			07.09 Mains under frequency 2 latched		Mask: 1000h	All
			07.10 Mains over voltage 1 latched		Mask: 0800h	All
			07.11 Mains over voltage 2 latched		Mask: 0400h	All
			07.12 Mains under voltage 1 latched		Mask: 0200h	All
			07.13 Mains under voltage 2 latched		Mask: 0100h	All
			07.14 Mains Phase shift latched		Mask: 0080h	All
			07.25 Mains decoupling latched		Mask: 0040h	All
			07.32 Mains AC Wiring		Mask: 0020h	All
			Internal		Mask: 0010h	
			Internal		Mask: 0008h	
			07.05 Mains Phase rotation mismatch latched		Mask: 0004h	All
			Internal		Mask: 0002h	
			Internal		Mask: 0001h	
50133	uint16	4188	BITLIST Alarms Mains active			
			Mains over frequency 1		Mask: 8000h	All
			Mains over frequency 2		Mask: 4000h	All
			Mains under frequency 1		Mask: 2000h	All
			Mains under frequency 2		Mask: 1000h	All

9 Appendix

9.2.7 Protocol 5016 (Basic Visualization)

Modbus-Address	Size	Index	Description	Unit	Scale	Model
			Mains over voltage 1		Mask: 0800h	All
			Mains over voltage 2		Mask: 0400h	All
			Mains under voltage 1		Mask: 0200h	All
			Mains under voltage 2		Mask: 0100h	All
			Mains Phase shift		Mask: 0080h	All
			Mains decoupling		Mask: 0040h	All
			Mains AC Wiring		Mask: 0020h	All
			Internal		Mask: 0010h	
			Internal		Mask: 0008h	
			Mains Phase rotation mismatch		Mask: 0004h	All
			Internal		Mask: 0002h	
			Internal		Mask: 0001h	
50134	uint16	10278	BITLIST Alarms Mains 1 latched (unacknowledged)			
			07.21 Mains import power 1 latched		Mask: 8000h	All
			07.22 Mains import power 2 latched		Mask: 4000h	All
			07.23 Mains export power 1 latched		Mask: 2000h	All
			07.24 Mains export power 2 latched		Mask: 1000h	All
			07.17 Mains PF lagging 1 latched		Mask: 0800h	All
			07.18 Mains PF lagging 2 latched		Mask: 0400h	All
			07.19 Mains PF leading 1 latched		Mask: 0200h	All
			07.20 Mains PF leading 2 latched		Mask: 0100h	All
			07.15 Mains df/dt latched		Mask: 0080h	All
			07.16 Mains active power mismatch latched		Mask: 0040h	All
			07.28 Mains Time-dep. Voltage 1 (FRT) latched		Mask: 0020h	All
			07.33 Mains Time-dep. Voltage 3 (FRT) latched		Mask: 0010h	All
			07.27 Mains slow voltage increase (10 min)		Mask: 0008h	All
			07.31 Mains Time-dep. Voltage 2 (FRT) latched		Mask: 0004h	All
			07.29 Mains QV Monitoring step 1 latched		Mask: 0002h	All
			07.30 Mains QV Monitoring step 2 latched		Mask: 0001h	All
50135	uint16	4187	BITLIST Alarms Mains 1 active			
			Mains import power 1		Mask: 8000h	All
			Mains import power 2		Mask: 4000h	All
			Mains export power 1		Mask: 2000h	All
			Mains export power 2		Mask: 1000h	All
			Mains PF lagging 1		Mask: 0800h	All
			Mains PF lagging 2		Mask: 0400h	All
			Mains PF leading 1		Mask: 0200h	All

Modbus-Address	Size	Index	Description	Unit	Scale	Model
			Mains PF leading 2		Mask: 0100h	All
			Mains df/dt		Mask: 0080h	All
			Mains active power mismatch		Mask: 0040h	All
			Mains Time-dep. Voltage 1 (FRT)		Mask: 0020h	All
			Mains Time-dep. Voltage 3 (FRT)		Mask: 0010h	All
			Mains slow voltage increase (10 min)		Mask: 0008h	All
			Mains Time-dep. Voltage 2 (FRT)		Mask: 0004h	All
			QV Monitoring 1 tripped		Mask: 0002h	All
			QV Monitoring 2 tripped		Mask: 0001h	All
50136	uint16	15968	BITGROUP States			
			Internal		Mask: F000h	
		15969	Engine state 2: Off 3: Preglow 4: Crank 5: Run 6: Cool down 7: Spin down 8: Start pause 9: Idle 10: Run-up synchr. mode active 11: Run-up synchr. wait on excitation 0, 1 12, 13... : internal		Mask: 0F00h	All
		15970	Reactive load control state 2: Static 3: Isochronous 4: Reactive load control 0, 1, 5, 6, 7, 8, 9, 11, ... : internal		Mask: 00F0h	All
		15971	Real load control state 2: Static 3: Isochronous 4: Base load control 5: Export/import control 0, 1, 6, 7, 8, 9, 10, 11, ... : internal		Mask: 000Fh	All
50137	int16		Internal			
Subtopic Digital Inputs						

Modbus-Address	Size	Index	Description	Unit	Scale	Model
50138	uint16	10132	BITLIST Alarms DI 1 latched (unacknowledged)			
			09.01 Discrete input 1 latched		Mask: 8000h	All
			09.02 Discrete input 2 latched		Mask: 4000h	All
			09.03 Discrete input 3 latched		Mask: 2000h	All
			09.04 Discrete input 4 latched		Mask: 1000h	All
			09.05 Discrete input 5 latched		Mask: 0800h	All
			09.06 Discrete input 6 latched		Mask: 0400h	All
			09.07 Discrete input 7 latched		Mask: 0200h	All
			09.08 Discrete input 8 latched		Mask: 0100h	All
			09.09 Discrete input 9 latched		Mask: 0080h	All
			09.10 Discrete input 10 latched		Mask: 0040h	All
			09.11 Discrete input 11 latched		Mask: 0020h	All
			09.12 Discrete input 12 latched		Mask: 0010h	All
			Internal		Mask: 0008h	
			Internal		Mask: 0004h	
			Internal		Mask: 0002h	
			Internal		Mask: 0001h	
50139	uint16	4181	BITLIST Alarms DI 1 active			
			Discrete input 1		Mask: 8000h	All
			Discrete input 2		Mask: 4000h	All
			Discrete input 3		Mask: 2000h	All
			Discrete input 4		Mask: 1000h	All
			Discrete input 5		Mask: 0800h	All
			Discrete input 6		Mask: 0400h	All
			Discrete input 7		Mask: 0200h	All
			Discrete input 8		Mask: 0100h	All
			Discrete input 9		Mask: 0080h	All
			Discrete input 10		Mask: 0040h	All
			Discrete input 11		Mask: 0020h	All
			Discrete input 12		Mask: 0010h	All
			Internal		Mask: 0008h	
			Internal		Mask: 0004h	
			Internal		Mask: 0002h	
			Internal		Mask: 0001h	
50140	uint16	16377	BITLIST Alarms Ext. DI 1 latched (unacknowledged)			
			12.16 External discrete input 16 latched		Mask: 8000h	All
			12.15 External discrete input 15 latched		Mask: 4000h	All

Modbus-Address	Size	Index	Description	Unit	Scale	Model
			12.14 External discrete input 14 latched		Mask: 2000h	All
			12.13 External discrete input 13 latched		Mask: 1000h	All
			12.12 External discrete input 12 latched		Mask: 0800h	All
			12.11 External discrete input 11 latched		Mask: 0400h	All
			12.10 External discrete input 10 latched		Mask: 0200h	All
			12.09 External discrete input 9 latched		Mask: 0100h	All
			12.08 External discrete input 8 latched		Mask: 0080h	All
			12.07 External discrete input 7 latched		Mask: 0040h	All
			12.06 External discrete input 6 latched		Mask: 0020h	All
			12.05 External discrete input 5 latched		Mask: 0010h	All
			12.04 External discrete input 4 latched		Mask: 0008h	All
			12.03 External discrete input 3 latched		Mask: 0004h	All
			12.02 External discrete input 2 latched		Mask: 0002h	All
			12.01 External discrete input 1 latched		Mask: 0001h	All
50141	uint16	4185	BITLIST Alarms Ext. DI 1 active			
			External discrete input 16		Mask: 8000h	All
			External discrete input 15		Mask: 4000h	All
			External discrete input 14		Mask: 2000h	All
			External discrete input 13		Mask: 1000h	All
			External discrete input 12		Mask: 0800h	All
			External discrete input 11		Mask: 0400h	All
			External discrete input 10		Mask: 0200h	All
			External discrete input 9		Mask: 0100h	All
			External discrete input 8		Mask: 0080h	All
			External discrete input 7		Mask: 0040h	All
			External discrete input 6		Mask: 0020h	All
			External discrete input 5		Mask: 0010h	All
			External discrete input 4		Mask: 0008h	All
			External discrete input 3		Mask: 0004h	All
			External discrete input 2		Mask: 0002h	All
			External discrete input 1		Mask: 0001h	All
50142	uint16	10284	BITLIST Alarm Ext. DI 2 latched (unacknowledged)			
			12.32 External discrete input 32 latched		Mask: 8000h	All
			12.31 External discrete input 31 latched		Mask: 4000h	All
			12.30 External discrete input 30 latched		Mask: 2000h	All
			12.29 External discrete input 29 latched		Mask: 1000h	All
			12.28 External discrete input 28 latched		Mask: 0800h	All

Modbus-Address	Size	Index	Description	Unit	Scale	Model
			12.27 External discrete input 27 latched		Mask: 0400h	All
			12.26 External discrete input 26 latched		Mask: 0200h	All
			12.25 External discrete input 25 latched		Mask: 0100h	All
			12.24 External discrete input 24 latched		Mask: 0080h	All
			12.23 External discrete input 23 latched		Mask: 0040h	All
			12.22 External discrete input 22 latched		Mask: 0020h	All
			12.21 External discrete input 21 latched		Mask: 0010h	All
			12.20 External discrete input 20 latched		Mask: 0008h	All
			12.19 External discrete input 19 latched		Mask: 0004h	All
			12.18 External discrete input 18 latched		Mask: 0002h	All
			12.17 External discrete input 17 latched		Mask: 0001h	All
50143	uint16	4195	BITLIST Alarm Ext. DI 2 active			
			External discrete input 32		Mask: 8000h	All
			External discrete input 31		Mask: 4000h	All
			External discrete input 30		Mask: 2000h	All
			External discrete input 29		Mask: 1000h	All
			External discrete input 28		Mask: 0800h	All
			External discrete input 27		Mask: 0400h	All
			External discrete input 26		Mask: 0200h	All
			External discrete input 25		Mask: 0100h	All
			External discrete input 24		Mask: 0080h	All
			External discrete input 23		Mask: 0040h	All
			External discrete input 22		Mask: 0020h	All
			External discrete input 21		Mask: 0010h	All
			External discrete input 20		Mask: 0008h	All
			External discrete input 19		Mask: 0004h	All
			External discrete input 18		Mask: 0002h	All
			External discrete input 17		Mask: 0001h	All
50144	uint16	10283	BITLIST Alarms DI 2 latched (unacknowledged)			
			09.13 Discrete input 13 latched		Mask: 8000h	EG3500XT-P2
			09.14 Discrete input 14 latched		Mask: 4000h	EG3500XT-P2
			09.15 Discrete input 15 latched		Mask: 2000h	EG3500XT-P2
			09.16 Discrete input 16 latched		Mask: 1000h	EG3500XT-P2
			09.17 Discrete input 17 latched		Mask: 0800h	EG3500XT-P2
			09.18 Discrete input 18 latched		Mask: 0400h	EG3500XT-P2
			09.19 Discrete input 19 latched		Mask: 0200h	EG3500XT-P2
			09.20 Discrete input 20 latched		Mask: 0100h	EG3500XT-P2

Modbus-Address	Size	Index	Description	Unit	Scale	Model
			09.21 Discrete input 21 latched		Mask: 0080h	EG3500XT-P2
			09.22 Discrete input 22 latched		Mask: 0040h	EG3500XT-P2
			09.23 Discrete input 23 latched		Mask: 0020h	EG3500XT-P2
			Internal		Mask: 0010h	
			Internal		Mask: 0008h	
			Internal		Mask: 0004h	
			Internal		Mask: 0002h	
			Internal		Mask: 0001h	
50145	uint16	4183	BITLIST Alarms DI 2 active			
			Discrete input 13		Mask: 8000h	EG3500XT-P2
			Discrete input 14		Mask: 4000h	EG3500XT-P2
			Discrete input 15		Mask: 2000h	EG3500XT-P2
			Discrete input 16		Mask: 1000h	EG3500XT-P2
			Discrete input 17		Mask: 0800h	EG3500XT-P2
			Discrete input 18		Mask: 0400h	EG3500XT-P2
			Discrete input 19		Mask: 0200h	EG3500XT-P2
			Discrete input 20		Mask: 0100h	EG3500XT-P2
			Discrete input 21		Mask: 0080h	EG3500XT-P2
			Discrete input 22		Mask: 0040h	EG3500XT-P2
			Discrete input 23		Mask: 0020h	EG3500XT-P2
			Internal		Mask: 0010h	
			Internal		Mask: 0008h	
			Internal		Mask: 0004h	
			Internal		Mask: 0002h	
			Internal		Mask: 0001h	
50146	int16		Internal			
50147	int16		Internal			
50148	int16		Internal			
50149	int16		Internal			
Subtopic Flexible Thresholds						
50150	uint16	10279	BITLIST Alarms Flex.Thresholds 1-16 latched			
			15.16 Flexible limit 16 latched		Mask: 8000h	All
			15.15 Flexible limit 15 latched		Mask: 4000h	All
			15.14 Flexible limit 14 latched		Mask: 2000h	All
			15.13 Flexible limit 13 latched		Mask: 1000h	All
			15.12 Flexible limit 12 latched		Mask: 0800h	All
			15.11 Flexible limit 11 latched		Mask: 0400h	All

Modbus-Address	Size	Index	Description	Unit	Scale	Model
			15.10 Flexible limit 10 latched		Mask: 0200h	All
			15.09 Flexible limit 9 latched		Mask: 0100h	All
			15.08 Flexible limit 8 latched		Mask: 0080h	All
			15.07 Flexible limit 7 latched		Mask: 0040h	All
			15.06 Flexible limit 6 latched		Mask: 0020h	All
			15.05 Flexible limit 5 latched		Mask: 0010h	All
			15.04 Flexible limit 4 latched		Mask: 0008h	All
			15.03 Flexible limit 3 latched		Mask: 0004h	All
			15.02 Flexible limit 2 latched		Mask: 0002h	All
			15.01 Flexible limit 1 latched		Mask: 0001h	All
50151	uint16	4175	BITLIST Alarms Flex.Thresholds 1-16 active			
			Flexible limit 16		Mask: 8000h	All
			Flexible limit 15		Mask: 4000h	All
			Flexible limit 14		Mask: 2000h	All
			Flexible limit 13		Mask: 1000h	All
			Flexible limit 12		Mask: 0800h	All
			Flexible limit 11		Mask: 0400h	All
			Flexible limit 10		Mask: 0200h	All
			Flexible limit 9		Mask: 0100h	All
			Flexible limit 8		Mask: 0080h	All
			Flexible limit 7		Mask: 0040h	All
			Flexible limit 6		Mask: 0020h	All
			Flexible limit 5		Mask: 0010h	All
			Flexible limit 4		Mask: 0008h	All
			Flexible limit 3		Mask: 0004h	All
			Flexible limit 2		Mask: 0002h	All
			Flexible limit 1		Mask: 0001h	All
50152	uint16	10280	BITLIST Alarms Flex.Thresholds 17-32 latched			
			15.32 Flexible limit 32 latched		Mask: 8000h	All
			15.31 Flexible limit 31 latched		Mask: 4000h	All
			15.30 Flexible limit 30 latched		Mask: 2000h	All
			15.29 Flexible limit 29 latched		Mask: 1000h	All
			15.28 Flexible limit 28 latched		Mask: 0800h	All
			15.27 Flexible limit 27 latched		Mask: 0400h	All
			15.26 Flexible limit 26 latched		Mask: 0200h	All
			15.25 Flexible limit 25 latched		Mask: 0100h	All
			15.24 Flexible limit 24 latched		Mask: 0080h	All

Modbus-Address	Size	Index	Description	Unit	Scale	Model
			15.23 Flexible limit 23 latched		Mask: 0040h	All
			15.22 Flexible limit 22 latched		Mask: 0020h	All
			15.21 Flexible limit 21 latched		Mask: 0010h	All
			15.20 Flexible limit 20 latched		Mask: 0008h	All
			15.19 Flexible limit 19 latched		Mask: 0004h	All
			15.18 Flexible limit 18 latched		Mask: 0002h	All
			15.17 Flexible limit 17 latched		Mask: 0001h	All
50153	uint16	4177	BITLIST Alarms Flex.Thresholds 17-32 active			
			Flexible limit 32		Mask: 8000h	All
			Flexible limit 31		Mask: 4000h	All
			Flexible limit 30		Mask: 2000h	All
			Flexible limit 29		Mask: 1000h	All
			Flexible limit 28		Mask: 0800h	All
			Flexible limit 27		Mask: 0400h	All
			Flexible limit 26		Mask: 0200h	All
			Flexible limit 25		Mask: 0100h	All
			Flexible limit 24		Mask: 0080h	All
			Flexible limit 23		Mask: 0040h	All
			Flexible limit 22		Mask: 0020h	All
			Flexible limit 21		Mask: 0010h	All
			Flexible limit 20		Mask: 0008h	All
			Flexible limit 19		Mask: 0004h	All
			Flexible limit 18		Mask: 0002h	All
			Flexible limit 17		Mask: 0001h	All
50154	uint16	10281	BITLIST Alarms Flex.Thresholds 33-40 latched			
			Internal		Mask: 8000h	
			Internal		Mask: 4000h	
			Internal		Mask: 2000h	
			Internal		Mask: 1000h	
			Internal		Mask: 0800h	
			Internal		Mask: 0400h	
			Internal		Mask: 0200h	
			Internal		Mask: 0100h	
			15.40 Flexible limit 40 latched		Mask: 0080h	All
			15.39 Flexible limit 39 latched		Mask: 0040h	All
			15.38 Flexible limit 38 latched		Mask: 0020h	All
			15.37 Flexible limit 37 latched		Mask: 0010h	All

Modbus-Address	Size	Index	Description	Unit	Scale	Model
			15.36 Flexible limit 36 latched		Mask: 0008h	All
			15.35 Flexible limit 35 latched		Mask: 0004h	All
			15.34 Flexible limit 34 latched		Mask: 0002h	All
			15.33 Flexible limit 33 latched		Mask: 0001h	All
50155	uint16	4179	BITLIST Alarms Flex.Thresholds 33-40 active			
			Internal		Mask: 8000h	
			Internal		Mask: 4000h	
			Internal		Mask: 2000h	
			Internal		Mask: 1000h	
			Internal		Mask: 0800h	
			Internal		Mask: 0400h	
			Internal		Mask: 0200h	
			Internal		Mask: 0100h	
			Flexible limit 40		Mask: 0080h	All
			Flexible limit 39		Mask: 0040h	All
			Flexible limit 38		Mask: 0020h	All
			Flexible limit 37		Mask: 0010h	All
			Flexible limit 36		Mask: 0008h	All
			Flexible limit 35		Mask: 0004h	All
			Flexible limit 34		Mask: 0002h	All
			Flexible limit 33		Mask: 0001h	All
50156	int16		Internal			
50157	int16		Internal			
50158	int16		Internal			
Subtopic DC Analogue Values Wirebreak						
50159	uint16	10137	BITLIST Alarms AI Wire Break latched			
			Internal		Mask: 0001h	
			10.01 Analog input 1 wire break		Mask: 0002h	All
			10.02 Analog input 2 wire break		Mask: 0004h	All
			10.03 Analog input 3 wire break		Mask: 0008h	All
			10.04 Analog input 4 wire break		Mask: 0010h	EG3500XT-P2
			10.05 Analog input 5 wire break		Mask: 0020h	EG3500XT-P2
			10.06 Analog input 6 wire break		Mask: 0040h	EG3500XT-P2
			10.07 Analog input 7 wire break		Mask: 0080h	EG3500XT-P2
			10.08 Analog input 8 wire break		Mask: 0100h	EG3500XT-P2
			10.09 Analog input 9 wire break		Mask: 0200h	EG3500XT-P2
			10.10 Analog input 10 wire break		Mask: 0400h	EG3500XT-P2

Modbus-Address	Size	Index	Description	Unit	Scale	Model
			Internal		Mask: 0800h	
			Internal		Mask: 1000h	
			Internal		Mask: 2000h	
			Internal		Mask: 4000h	
			Internal		Mask: 8000h	
50160	uint16	4173	BITLIST Alarms AI Wire Break active			
			Internal		Mask: 0001h	
			Analog input 1 wire break		Mask: 0002h	All
			Analog input 2 wire break		Mask: 0004h	All
			Analog input 3 wire break		Mask: 0008h	All
			Analog input 4 wire break		Mask: 0010h	EG3500XT-P2
			Analog input 5 wire break		Mask: 0020h	EG3500XT-P2
			Analog input 6 wire break		Mask: 0040h	EG3500XT-P2
			Analog input 7 wire break		Mask: 0080h	EG3500XT-P2
			Analog input 8 wire break		Mask: 0100h	EG3500XT-P2
			Analog input 9 wire break		Mask: 0200h	EG3500XT-P2
			Analog input 10 wire break		Mask: 0400h	EG3500XT-P2
			Internal		Mask: 0800h	
			Internal		Mask: 1000h	
			Internal		Mask: 2000h	
			Internal		Mask: 4000h	
			Internal		Mask: 8000h	
50161	uint16	10285	BITLIST Alarms Ext.AI Wire Break latched			
			25.01 Ext. analog input 1 wire break		Mask: 0001h	All
			25.02 Ext. analog input 2 wire break		Mask: 0002h	All
			25.03 Ext. analog input 3 wire break		Mask: 0004h	All
			25.04 Ext. analog input 4 wire break		Mask: 0008h	All
			25.05 Ext. analog input 5 wire break		Mask: 0010h	All
			25.06 Ext. analog input 6 wire break		Mask: 0020h	All
			25.07 Ext. analog input 7 wire break		Mask: 0040h	All
			25.08 Ext. analog input 8 wire break		Mask: 0080h	All
			25.09 Ext. analog input 9 wire break		Mask: 0100h	All
			25.10 Ext. analog input 10 wire break		Mask: 0200h	All
			25.11 Ext. analog input 11 wire break		Mask: 0400h	All
			25.12 Ext. analog input 12 wire break		Mask: 0800h	All
			25.13 Ext. analog input 13 wire break		Mask: 1000h	All
			25.14 Ext. analog input 14 wire break		Mask: 2000h	All

Modbus-Address	Size	Index	Description	Unit	Scale	Model
			25.15 Ext. analog input 15 wire break		Mask: 4000h	All
			25.16 Ext. analog input 16 wire break		Mask: 8000h	All
50162	uint16	4196	BITLIST Alarms Ext.AI Wire Break active			
			Ext. analog input 1 wire break		Mask: 0001h	All
			Ext. analog input 2 wire break		Mask: 0002h	All
			Ext. analog input 3 wire break		Mask: 0004h	All
			Ext. analog input 4 wire break		Mask: 0008h	All
			Ext. analog input 5 wire break		Mask: 0010h	All
			Ext. analog input 6 wire break		Mask: 0020h	All
			Ext. analog input 7 wire break		Mask: 0040h	All
			Ext. analog input 8 wire break		Mask: 0080h	All
			Ext. analog input 9 wire break		Mask: 0100h	All
			Ext. analog input 10 wire break		Mask: 0200h	All
			Ext. analog input 11 wire break		Mask: 0400h	All
			Ext. analog input 12 wire break		Mask: 0800h	All
			Ext. analog input 13 wire break		Mask: 1000h	All
			Ext. analog input 14 wire break		Mask: 2000h	All
			Ext. analog input 15 wire break		Mask: 4000h	All
			Ext. analog input 16 wire break		Mask: 8000h	All
50163	int16		Internal			
50164	int16		Internal			
Subtopic Other Alarms						
50165	uint16	10286	BITLIST Other Alarms 1 latched (unacknowledged)			
			08.53 LS interface redundancy latched		Mask: 8000h	EG3500XT-P1 EG3500XT-P2
			Internal		Mask: 4000h	
			Free alarm 4		Mask: 2000h	All
			Free alarm 3		Mask: 1000h	All
			Free alarm 2		Mask: 0800h	All
			Free alarm 1		Mask: 0400h	All
			05.21 Max. starts per time		Mask: 0200h	K36
			17.09 Neutral interl. reply mismatch latched		Mask: 0100h	All
			17.08 Decoupling GCB-MCB latched		Mask: 0080h	All
			17.07 Measurement difference 4105 latched		Mask: 0040h	All
			17.06 Parameter alignment 4105 latched		Mask: 0020h	All
			17.05 Missing member 4105 latched		Mask: 0010h	All

Modbus-Address	Size	Index	Description	Unit	Scale	Model
			08.22 Busbar v/f not ok latched		Mask: 0008h	All
			08.21 Feedback GCB mismatch latched		Mask: 0004h	MARINE
			17.02 Reactive load share mismatch latched		Mask: 0002h	All
			17.01 Active load share mismatch latched		Mask: 0001h	All
50166	uint16	5197	BITLIST Other Alarms 1 active			
			LS interface redundancy active		Mask: 8000h	EG3500XT-P1 EG3500XT-P2
			Internal		Mask: 4000h	
			Free alarm 4 active		Mask: 2000h	All
			Free alarm 3 active		Mask: 1000h	All
			Free alarm 2 active		Mask: 0800h	All
			Free alarm 1 active		Mask: 0400h	All
			Internal		Mask: 0200h	
			Neutral contactor failure active		Mask: 0100h	All
			Decoupling GCB-MCB active		Mask: 0080h	All
			Meas.difference 4105 VDE-AR-N 4105 active		Mask: 0040h	All
			Parameter alignment VDE-AR-N 4105 active		Mask: 0020h	All
			Missing member VDE-AR-N 4105 active		Mask: 0010h	All
			Busbar monitoring latched active		Mask: 0008h	All
			Internal		Mask: 0004h	
			Reactive load sharing mismatch latched		Mask: 0002h	All
			Active load sharing mismatch latched		Mask: 0001h	All
50167	uint16	4085	BITLIST Internal Flags 1-16			
			96.16 LM Internal Flag 16		Mask: 8000h	All
			96.15 LM Internal Flag 15		Mask: 4000h	All
			96.14 LM Internal Flag 14		Mask: 2000h	All
			96.13 LM Internal Flag 13		Mask: 1000h	All
			96.12 LM Internal Flag 12		Mask: 0800h	All
			96.11 LM Internal Flag 11		Mask: 0400h	All
			96.10 LM Internal Flag 10		Mask: 0200h	All
			96.09 LM Internal Flag 9		Mask: 0100h	All
			96.08 LM Internal Flag 8		Mask: 0080h	All
			96.07 LM Internal Flag 7		Mask: 0040h	All
			96.06 LM Internal Flag 6		Mask: 0020h	All
			96.05 LM Internal Flag 5		Mask: 0010h	All
			96.04 LM Internal Flag 4		Mask: 0008h	All
			96.03 LM Internal Flag 3		Mask: 0004h	All

9 Appendix

9.2.7 Protocol 5016 (Basic Visualization)

Modbus-Address	Size	Index	Description	Unit	Scale	Model
			96.02 LM Internal Flag 2		Mask: 0002h	All
			96.01 LM Internal Flag 1		Mask: 0001h	All
50168	uint16	4095	BITLIST Internal Flags 17-32			
			96.32 LM Internal Flag 32		Mask: 8000h	All
			96.31 LM Internal Flag 31		Mask: 4000h	All
			96.30 LM Internal Flag 30		Mask: 2000h	All
			96.29 LM Internal Flag 29		Mask: 1000h	All
			96.28 LM Internal Flag 28		Mask: 0800h	All
			96.27 LM Internal Flag 27		Mask: 0400h	All
			96.26 LM Internal Flag 26		Mask: 0200h	All
			96.25 LM Internal Flag 25		Mask: 0100h	All
			96.24 LM Internal Flag 24		Mask: 0080h	All
			96.23 LM Internal Flag 23		Mask: 0040h	All
			96.22 LM Internal Flag 22		Mask: 0020h	All
			96.21 LM Internal Flag 21		Mask: 0010h	All
			96.20 LM Internal Flag 20		Mask: 0008h	All
			96.19 LM Internal Flag 19		Mask: 0004h	All
			96.18 LM Internal Flag 18		Mask: 0002h	All
			96.17 LM Internal Flag 17		Mask: 0001h	All
50169	uint16	10282	BITLIST Free Alarms 1 latched (unacknowledged)			
			16.16 Free alarm 16 latched		Mask: 8000h	All
			16.15 Free alarm 15 latched		Mask: 4000h	All
			16.14 Free alarm 14 latched		Mask: 2000h	All
			16.13 Free alarm 13 latched		Mask: 1000h	All
			16.12 Free alarm 12 latched		Mask: 0800h	All
			16.11 Free alarm 11 latched		Mask: 0400h	All
			16.10 Free alarm 10 latched		Mask: 0200h	All
			16.09 Free alarm 9 latched		Mask: 0100h	All
			16.08 Free alarm 8 latched		Mask: 0080h	All
			16.07 Free alarm 7 latched		Mask: 0040h	All
			16.06 Free alarm 6 latched		Mask: 0020h	All
			16.05 Free alarm 5 latched		Mask: 0010h	All
			16.04 Free alarm 4 latched		Mask: 0008h	All
			16.03 Free alarm 3 latched		Mask: 0004h	All
			16.02 Free alarm 2 latched		Mask: 0002h	All
			16.01 Free alarm 1 latched		Mask: 0001h	All
50170	uint16	4194	BITLIST Free Alarms 1 active			

Modbus-Address	Size	Index	Description	Unit	Scale	Model
			Free alarm 16 active		Mask: 8000h	All
			Free alarm 15 active		Mask: 4000h	All
			Free alarm 14 active		Mask: 2000h	All
			Free alarm 13 active		Mask: 1000h	All
			Free alarm 12 active		Mask: 0800h	All
			Free alarm 11 active		Mask: 0400h	All
			Free alarm 10 active		Mask: 0200h	All
			Free alarm 9 active		Mask: 0100h	All
			Free alarm 8 active		Mask: 0080h	All
			Free alarm 7 active		Mask: 0040h	All
			Free alarm 6 active		Mask: 0020h	All
			Free alarm 5 active		Mask: 0010h	All
			Free alarm 4 active		Mask: 0008h	All
			Free alarm 3 active		Mask: 0004h	All
			Free alarm 2 active		Mask: 0002h	All
			Free alarm 1 active		Mask: 0001h	All
Topic Engine Management						
Subtopic Active Diagnostic Trouble Code (DM1) 1-10 (SPN Range 0...65535)full SPN value at 450425-450444						
1. Active Diagnostic Trouble Code (DM1)						
50171	uint16	15400	SPN of 1. entry		low 16 bits of 19 bits of SPN	All
50172	uint16	15972	BITGROUP			
		15401	FMI		Mask FF00h	All
		15402	OC		Mask 00FFh	All
2. Active Diagnostic Trouble Code (DM1)						
50173	uint16	15403	SPN of 2. entry		low 16 bits of 19 bits of SPN	All
50174	uint16	15973	BITGROUP			
		15404	FMI		Mask FF00h	All
		15405	OC		Mask 00FFh	All
3. Active Diagnostic Trouble Code (DM1)						
50175	uint16	15406	SPN of 3. entry		low 16 bits of 19 bits of SPN	All
50176	uint16	15974	BITGROUP			
		15407	FMI		Mask FF00h	All
		15408	OC		Mask 00FFh	All
4. Active Diagnostic Trouble Code (DM1)						
50177	uint16	15409	SPN of 4. entry		low 16 bits of 19 bits of SPN	All

Modbus-Address	Size	Index	Description	Unit	Scale	Model
50178	uint16	15975	BITGROUP			
		15410	FMI		Mask FF00h	All
		15411	OC		Mask 00FFh	All
5. Active Diagnostic Trouble Code (DM1)						
50179	uint16	15412	SPN of 5. entry		low 16 bits of 19 bits of SPN	All
50180	uint16	15976	BITGROUP			
		15413	FMI		Mask FF00h	All
		15414	OC		Mask 00FFh	All
6. Active Diagnostic Trouble Code (DM1)						
50181	uint16	15415	SPN of 6. entry		low 16 bits of 19 bits of SPN	All
50182	uint16	15977	BITGROUP			
		15416	FMI		Mask FF00h	All
		15418	OC		Mask 00FFh	All
7. Active Diagnostic Trouble Code (DM1)						
50183	uint16	15419	SPN of 7. entry		low 16 bits of 19 bits of SPN	All
50184	uint16	15978	BITGROUP			
		15420	FMI		Mask FF00h	All
		15421	OC		Mask 00FFh	All
8. Active Diagnostic Trouble Code (DM1)						
50185	uint16	15422	SPN of 8. entry		low 16 bits of 19 bits of SPN	All
50186	uint16	15979	BITGROUP			
		15423	FMI		Mask FF00h	All
		15424	OC		Mask 00FFh	All
9. Active Diagnostic Trouble Code (DM1)						
50187	uint16	15425	SPN of 9. entry		low 16 bits of 19 bits of SPN	All
50188	uint16	15980	BITGROUP			
		15426	FMI		Mask FF00h	All
		15427	OC		Mask 00FFh	All
10. Active Diagnostic Trouble Code (DM1)						
50189	uint16	15428	SPN of 10. entry		low 16 bits of 19 bits of SPN	All
50190	uint16	15981	BITGROUP			
		15429	FMI		Mask FF00h	All
		15430	OC		Mask 00FFh	All
Subtopic DM1 Lamp Status						

Modbus-Address	Size	Index	Description	Unit	Scale	Model
50191	uint16	15395	BITLIST J1939 Lamp Status DM1			
			Internal		Mask 8000h	
			Internal		Mask 4000h	
			On Malfunction Lamp		Mask 2000h	All
			Off Malfunction Lamp		Mask 1000h	All
			Internal		Mask 0800h	
			Internal		Mask 0400h	
			On Red Stop Lamp		Mask 0200h	All
			Off Red Stop Lamp		Mask 0100h	All
			Internal		Mask 0080h	
			Internal		Mask 0040h	
			On Amber Warning Lamp		Mask 0020h	All
			Off Amber Warning Lamp		Mask 0010h	All
			Internal		Mask 0008h	
			Internal		Mask 0004h	
			On Protect Lamp		Mask 0002h	All
			Off Protect Lamp		Mask 0001h	All
Subtopic DM2 Lamp Status						
50192	uint16	15445	BITLIST J1939 Lamp Status DM2			
			Internal		Mask 8000h	
			Internal		Mask 4000h	
			On Malfunction Lamp		Mask 2000h	All
			Off Malfunction Lamp		Mask 1000h	All
			Internal		Mask 0800h	
			Internal		Mask 0400h	
			On Red Stop Lamp		Mask 0200h	All
			Off Red Stop Lamp		Mask 0100h	All
			Internal		Mask 0080h	
			Internal		Mask 0040h	
			On Amber Warning Lamp		Mask 0020h	All
			Off Amber Warning Lamp		Mask 0010h	All
			Internal		Mask 0008h	
			Internal		Mask 0004h	
			On Protect Lamp		Mask 0002h	All
			Off Protect Lamp		Mask 0001h	All
Subtopic Especially Failure Codes						
50193	uint16	15109	J1939 MTU ADEC ECU Failure Codes		*1	All

Modbus-Address	Size	Index	Description	Unit	Scale	Model
50194	int16		Internal			
50195	uint16	15304	J1939 EMR Engine Stop Information (refer to DEUTZ-specific J1939-Message) "Missing" Value="65535" "Error" Value="65279" "Type 9" Value="9" "Type 8" Value="8" "Type 7" Value="7" "Type 6" Value="6" "Type 5" Value="5" "Type 4" Value="4" "Type 3" Value="3" "Type 2" Value="2" "Type 1" Value="1" "Type 0" Value="0"		*1	All
50196	int16		Internal			
50197	uint16	15305	BITLIST J1939 DLN2-Message Scania S6			
			Engine Coolant Temperature		Mask F000h	
			J1939-Message not available		Mask 8000h	All
			Sensor fault		Mask 4000h	All
			High Temperature.		Mask 2000h	All
			NOT High Temperature		Mask 1000h	All
			Engine Oil Pressure		Mask 0F00h	
			J1939-Message not available		Mask 0800h	All
			Sensor fault		Mask 0400h	All
			Low Pressure		Mask 0200h	All
			NOT Low Pressure		Mask 0100h	All
			High Engine Oil Level		Mask 00F0h	
			J1939-Message not available		Mask 0080h	All
			Sensor fault		Mask 0040h	All
			High Level		Mask 0020h	All
			NOT High Level		Mask 0010h	All
			Low Engine Oil Level		Mask 000Fh	
			J1939-Message not available		Mask 0008h	All
			Sensor fault		Mask 0004h	All
			Low Level		Mask 0002h	All
			NOT Low Level		Mask 0001h	All

Modbus-Address	Size	Index	Description	Unit	Scale	Model
50198	int16		Internal			
50199	int16		Internal			
50200	int16		Internal			
Subtopic Values						
50201	int16	15308	Engine Speed (SPN 190)	rpm	*1	All
50202	int16	15202	Engine Coolant Temperature (SPN 110)	°C	*1	All
50203	int16	15203	Fuel temperature (SPN 174)	°C	*1	All
50204	int16	15309	Engine Oil Temperature 1 (SPN 175)	°C	*10	All
50205	int16	15205	Engine Oil Pressure (SPN 100)	kPa	*1	All
50206	int16	15307	Fuel Rate (SPN 183)	L/h	*10	All
50207	int16	15206	Coolant Level (SPN 111)	%	*10	All
50208	int16	15207	Throttle position (SPN 91)	%	*10	All
50209	int16	15208	Load at current Speed (SPN 92)	%	*1	All
50210	int16	15210	Engine oil level (SPN 98)	%	*10	All
50211	int16	15214	Boost pressure (SPN 102)	kPa	*1	All
50212	int16	15215	Intake Manifold 1 Temp (SPN 105)	°C	*1	All
50213	int16	15212	Barometric Pressure (SPN 108)	kPa	*10	All
50214	int16	15213	Air inlet temperature (SPN 172)	°C	*1	All
50215	int16	15209	Actual engine torque (SPN 513)	%	*1	All
50216	int16	15299	Exhaust Gas Temp.(SPN 173)	°C	*10	All
50217	int16	15217	Engine Intercooler Temp (SPN52)	°C	*1	All
50218	int16	15218	Fuel Delivery Pressure (SPN94)	kPa	*1	All
50219	int16	15219	Fuel Filter Differential Pressure (SPN95)	kPa	*1	All
50220	int16	15220	Crankcase Pressure (SPN101)	kPa	*1	All
50221	int16	15221	Turbo Air Inlet Pressure (SPN106)	kPa	*1	All
50222	int16	15222	Air Filter 1 Differential Pressure (SPN107)	kPa	*100	All
50223	int16	15223	Coolant Pressure (SPN109)	kPa	*1	All
50224	int16	15224	Transmission Oil Pressure (SPN127)	kPa	*1	All
50225	int16	15225	Fuel Rail Pressure (SPN157)	MPa	*10	All
50226	int16	15226	Ambient Air Temperature (SPN171)	°C	*10	All
50227	int16	15227	Turbo Oil Temperature (SPN176)	°C	*10	All
50228	int16	15228	Transmission Oil Temperature (SPN177)	°C	*10	All
50229	int16	15229	Auxiliary Temperature 1 (SPN441)	°C	*1	All
50230	int16	15230	Auxiliary Temperature 2 (SPN442)	°C	*1	All
50231	int16	15209	Actual engine torque (SPN 513)	%	*1	All
50232	int16	15231	Alternator Bear. 1 Temperature (SPN1122)	°C	*1	All
50233	int16	15232	Alternator Bear. 2 Temperature (SPN1123)	°C	*1	All

9 Appendix

9.2.7 Protocol 5016 (Basic Visualization)

Modbus-Address	Size	Index	Description	Unit	Scale	Model
50234	int16	15233	Alternator Wind. 1 Temperature (SPN1124)	°C	*1	All
50235	int16	15234	Alternator Wind. 2 Temperature (SPN1125)	°C	*1	All
50236	int16	15235	Alternator Wind. 3 Temperature (SPN1126)	°C	*1	All
50237	int16	15236	Intake Manifold 2 Temperature (SPN1131)	°C	*1	All
50238	int16	15237	Intake Manifold 3 Temperature (SPN1132)	°C	*1	All
50239	int16	15238	Intake Manifold 4 Temperature (SPN1133)	°C	*1	All
50240	int16	15239	Engine Intercooler Thermostat Opening (SPN1134)	%	*10	All
50241	int16	15240	Engine Oil Temperature 2 (SPN1135)	°C	*10	All
50242	int16	15241	Engine ECU Temperature (SPN1136)	°C	*10	All
50243	int16	15242	Exhaust Gas Port 1 Temperatures (SPN1137)	°C	*10	All
50244	int16	15243	Exhaust Gas Port 2 Temperatures (SPN1138)	°C	*10	All
50245	int16	15244	Exhaust Gas Port 3 Temperatures (SPN1139)	°C	*10	All
50246	int16	15245	Exhaust Gas Port 4 Temperatures (SPN1140)	°C	*10	All
50247	int16	15246	Exhaust Gas Port 5 Temperatures (SPN1141)	°C	*10	All
50248	int16	15247	Exhaust Gas Port 6 Temperatures (SPN1142)	°C	*10	All
50249	int16	15248	Exhaust Gas Port 7 Temperatures (SPN1143)	°C	*10	All
50250	int16	15249	Exhaust Gas Port 8 Temperatures (SPN1144)	°C	*10	All
50251	int16	15250	Exhaust Gas Port 9 Temperatures (SPN1145)	°C	*10	All
50252	int16	15251	Exhaust Gas Port 10 Temperatures (SPN1146)	°C	*10	All
50253	int16	15252	Exhaust Gas Port 11 Temperatures (SPN1147)	°C	*10	All
50254	int16	15253	Exhaust Gas Port 12 Temperatures (SPN1148)	°C	*10	All
50255	int16	15254	Exhaust Gas Port 13 Temperatures (SPN1149)	°C	*10	All
50256	int16	15255	Exhaust Gas Port 14 Temperatures (SPN1150)	°C	*10	All
50257	int16	15256	Exhaust Gas Port 15 Temperatures (SPN1151)	°C	*10	All
50258	int16	15257	Exhaust Gas Port 16 Temperatures (SPN1152)	°C	*10	All
50259	int16	15258	Exhaust Gas Port 17 Temperatures (SPN1153)	°C	*10	All
50260	int16	15259	Exhaust Gas Port 18 Temperatures (SPN1154)	°C	*10	All
50261	int16	15260	Exhaust Gas Port 19 Temperatures (SPN1155)	°C	*10	All
50262	int16	15261	Exhaust Gas Port 20 Temperatures (SPN1156)	°C	*10	All
50263	int16	15262	Main Bearing 1 Temperatures (SPN1157)	°C	*10	All
50264	int16	15263	Main Bearing 2 Temperatures (SPN1158)	°C	*10	All
50265	int16	15264	Main Bearing 3 Temperatures (SPN1159)	°C	*10	All
50266	int16	15265	Main Bearing 4 Temperatures (SPN1160)	°C	*10	All
50267	int16	15266	Main Bearing 5 Temperatures (SPN1161)	°C	*10	All
50268	int16	15267	Main Bearing 6 Temperatures (SPN1162)	°C	*10	All
50269	int16	15268	Main Bearing 7 Temperatures (SPN1163)	°C	*10	All
50270	int16	15269	Main Bearing 8 Temperatures (SPN1164)	°C	*10	All

Modbus-Address	Size	Index	Description	Unit	Scale	Model
50271	int16	15270	Main Bearing 9 Temperatures (SPN1165)	°C	*10	All
50272	int16	15271	Main Bearing 10 Temperatures (SPN1166)	°C	*10	All
50273	int16	15272	Main Bearing 11 Temperatures (SPN1167)	°C	*10	All
50274	int16	15273	Turbo 1 Compressor Inlet Temperatures (SPN1172)	°C	*10	All
50275	int16	15274	Turbo 2 Compressor Inlet Temperatures (SPN1173)	°C	*10	All
50276	int16	15275	Turbo 3 Compressor Inlet Temperatures (SPN1174)	°C	*10	All
50277	int16	15276	Turbo 4 Compressor Inlet Temperatures (SPN1175)	°C	*10	All
50278	int16	15277	Turbo 1 Compressor Inlet Pressure (SPN1176)	kPa	*1	All
50279	int16	15278	Turbo 2 Compressor Inlet Pressure (SPN1177)	kPa	*1	All
50280	int16	15279	Turbo 3 Compressor Inlet Pressure (SPN1178)	kPa	*1	All
50281	int16	15280	Turbo 4 Compressor Inlet Pressure (SPN1179)	kPa	*1	All
50282	int16	15281	Turbo 1 Turbine Inlet Temperature (SPN1180)	°C	*10	All
50283	int16	15282	Turbo 2 Turbine Inlet Temperature (SPN 1181)	°C	*10	All
50284	int16	15283	Turbo 3 Turbine Inlet Temperature (SPN 1182)	°C	*10	All
50285	int16	15284	Turbo 4 Turbine Inlet Temperature (SPN1183)	°C	*10	All
50286	int16	15285	Turbo 1 Turbine Outlet Temperature (SPN1184)	°C	*10	All
50287	int16	15286	Turbo 2 Turbine Outlet Temperature (SPN1185)	°C	*10	All
50288	int16	15287	Turbo 3 Turbine Outlet Temperature (SPN 1186)	°C	*10	All
50289	int16	15288	Turbo 4 Turbine Outlet Temperature (SPN1187)	°C	*10	All
50290	int16	15289	Engine Aux. Coolant Pressure (SPN1203)	kPa	*1	All
50291	int16	15290	Pre-filter Oil Pressure (SPN1208)	kPa	*1	All
50292	int16	15291	Engine Aux. Coolant Temperature (SPN1212)	°C	*1	All
50293	int16	15292	Fuel Filter Differential Pressure (SPN1382)	kPa	*1	All
50294	int16	15293	Battery 1 Temperature (SPN1800)	°C	*1	All
50295	int16	15294	Battery 2 Temperature (SPN1801)	°C	*1	All
50296	int16	15295	Intake Manifold 5 Temperature (SPN1802)	°C	*1	All
50297	int16	15296	Intake Manifold 6 Temperature (SPN1803)	°C	*1	All
50298	int16	15297	Right Exhaust Gas Temperature (SPN2433)	°C	*10	All
50299	int16	15298	Left Exhaust Gas Temperature (SPN2434)	°C	*10	All
50300	int16	15310	Turbo 1 Compr. Outlet Temperature (SPN2629)	°C	*10	All
50301	int16	15311	Engine derate request (SPN3644)	%	*10	All
50302	int16	15312	Batterie Potential (SPN0158)	V	*10	All
50303	int16	15313	Aftertreatment 1 Diesel Exhaust Fluid Tank 1 Level (SPN1761), (In Scania S8 mode: Urea level)	%	*10	All

9 Appendix

9.2.7 Protocol 5016 (Basic Visualization)

Modbus-Address	Size	Index	Description	Unit	Scale	Model
50304	int16	15314	Aftertreatment 1 Diesel Exhaust Fluid Tank 1 Temperature (SPN3031)	°C	*1	All
50305	int16	15315	Aftertreatment 1 Diesel Exhaust Fluid Tank 2 Level (SPN4367)	%	*10	All
50306	int16	15316	Aftertreatment 1 Diesel Exhaust Fluid Tank 2 Temperature (SPN4368)	°C	*1	All
50307	int16	12807	Exhaust Gas Temperature Average(SPN 4151)	°C	*10	All
50308	int16	12809	Exhaust Gas Temperature Average Bank 1 (SPN 4153)	°C	*10	All
50309	int16	12812	Exhaust Gas Temperature Average Bank 2 (SPN 4152)	°C	*10	All
50310	int16	12016	Fuel level 1 (SPN 96)	%	*10	All
50311	int16	12017	Fuel level 2 (SPN 38)	%	*10	All
50312	int16	15855	Time left to torque reduction(Volvo EMS2)	min	*1	All
50313	int16	15856	Time left to severe torque reduction (Volvo EMS2)	min	*1	All
50314	int16	15852	Number of EIO activation(Volvo EMS2)	-	*1	All
50315	int16	15853	Accumulated EIO time (Volvo EMS2)	h	*1	All
50316	int16	15854	Time left EIO operation(Volvo EMS2)	h	*1	All
50317	uint16	15982	J1939 States 01			
		15695	HC Evaporation Status (Scania S8) 0: Evaporation not required 1: Evaporation required, less urgent 2: Evaporation required urgent 3: Evaporation is in progress 4,5: Reserved 6: Error 7: Not available		Mask: E000h	All
		15399	Urea level inducement state (Scania S8) 0: Urea Level Ok 1: Low Urea Level 2: Fill Up Urea 3: Urea Tank Empty 4,5: Reserved 6: Error 7: Not available		Mask: 1C00h	All
		15983	Afterrun status (Scania S8) 0: Afterrun incative 1: Afterrun active 2: Error		Mask: 0300h	All

Modbus-Address	Size	Index	Description	Unit	Scale	Model
			3: Not available			
		15857	SCR inducement severity (Volvo EMS2) 0: No inducement active 1: Inducement warning 2: Not available 3: Derate active 4: Pre severe derate warning 5: Severe derate 6: Temporary override of derate 7: Not available		Mask: 00E0h	All
		15858	SCR inducement reason (Volvo EMS2) 0: OK 1: Reagent tank level low 2: Incorrect reagent quality 3: Absence of reagent dosing 4: Tampering 5-7: Not available		Mask: 001Ch	All
		15859	Restored operation (Volvo EMS2) 0: Not active 1: Active 2: Error 3: Not available		Mask: 0003h	All
50318	int16	12018	SPN 3719 DPF 1 Soot load	%	1	All
50319	int16	12019	SPN 3720 DPF 1 Ash load	%	1	All
50320	int16	12044	SPN 5466 DPF 1 Soot Load Regeneration Threshold	%	100	All
50321	uint16	15984	J1939 States 02			
		15985	SPN 3711 DPF Active Regeneration Inhibited Due to Low Exhaust Gas Temperature 0: not inhibited 1: inhibited 2: reserved for SAE assignment 3 not available		Mask: C000h	All
		15986	SPN 3703 DPF Active Regeneration Inhibited Due to Inhibit Switch 0: not inhibited 1: inhibited 2: reserved for SAE assignment		Mask: 3000h	All

Modbus-Address	Size	Index	Description	Unit	Scale	Model
			3: not available			
		15607	SPN 3702 DPF Active Regeneration Inhibited Status 0: not inhibited 1: inhibited 2: reserved for SAE assignment 3: not available		Mask: 0C00h	All
		15608	SPN 3699 DPF Passive Regeneration Status 0: not active 1: active 2: reserved for SAE assignment 3: not available		Mask: 0300h	All
		15507	SPN 3701 DPF Status 0: Regeneration not needed 1: Regeneration needed - lowest level 2: Regeneration needed - moderate level 3: Regeneration needed - highest level 4: reserved for SAE assignment 5: reserved for SAE assignment 6: reserved for SAE assignment 7: not available		Mask: 00E0h	All
		15506	SPN 3700 DPF Active Regeneration Status 0: not active 1: active 2: regeneration needed - automatically initiated active regeneration imminent 3: not available		Mask: 0018h	All
		15504	SPN 3697 DPF Lamp Command 0: Off 1: On - solid 2: reserved for SAE assignment 3: reserved for SAE assignment 4: On - fast blink (1 HZ) (Deutz EMR4 3Hz) 5: reserved for SAE assignment (Deutz EMR4 0.5 Hz slow blink, not supported because it is not standard) 6: reserved for SAE assignment 7: not available		Mask: 0007h	All

Modbus-Address	Size	Index	Description	Unit	Scale	Model
50322	uint16	15987	J1939 States 03			
			Internal		Mask: C000h	All
		15988	SPN 3750 DPF 1 Conditions Not Met for Active Regeneration 0: active DPF regeneration not inhibited 1: active DPF regeneration inhibited 2: reserved for SAE assignment 3: not available		Mask: 3000h	All
		15989	SPN 5629 DPF Active Regeneration Inhibited Due to Low Exhaust Gas Pressure 0: not inhibited 1: inhibited 2: reserved for SAE assignment 3: not available		Mask: 0C00h	All
		15990	SPN 3716 DPF Active Regeneration Inhibited Due to Engine Not Warmed Up 0: not inhibited 1: inhibited 2: reserved for SAE assignment 3: not available		Mask: 0300h	All
		15991	SPN 3715 DPF Active Regeneration Inhibited Due to Permanent System Lockout 0: not inhibited 1: inhibited 2: reserved for SAE assignment 3: not available		Mask: 00C0h	All
		15992	SPN 3714 DPF Active Regeneration Inhibited Due to Temporary System Lockout 0: not inhibited 1: inhibited 2: reserved for SAE assignment 3: not available		Mask: 0030h	All
		15993	SPN 3713 DPF Active Regeneration Inhibited Due to System Timeout 0: not inhibited 1: inhibited 2: reserved for SAE assignment 3: not available		Mask:000Ch	All

Modbus-Address	Size	Index	Description	Unit	Scale	Model
		15994	SPN 3712 DPF Active Regeneration Inhibited Due to System Fault Active 0: not inhibited 1: inhibited 2: reserved for SAE assignment 3: not available		Mask: 0003h	All
50323	uint16	15995	J1939 States 04			
		15694	Emission inducement failure reason (Scania S8) 0: OK 1: Dosing Error 2: Urea Quality 3: Monitor Failure 4: Nox Failure 5-13: Reserved for future assignment by Scania 14: Error 15: Not available		Mask: F000h	All
		15996	SPN 6918 SCR System Cleaning Inhibited Due to Inhibit Switch 0: not inhibited 1: inhibited 2: reserved for SAE assignment 3: not available		Mask: 0C00h	All
		12050	SPN 6915 SCR System Cleaning Lamp Command 0:Off 1: On - solid 2: reserved for SAE assignment 3: reserved for SAE assignment 4: On - fast blink (1 HZ) 5: reserved for SAE assignment 6: reserved for SAE assignment 7: not available		Mask: 0380h	All
		15505	SPN 3698 Exhaust System High Temperature Lamp Command 0: Off 1: On - solid 2: reserved for SAE assignment		Mask: 0070h	All

Modbus-Address	Size	Index	Description	Unit	Scale	Model
			3: reserved for SAE assignment 4: reserved for SAE assignment 5: reserved for SAE assignment 6: reserved for SAE assignment 7: not available			
		12049	SPN 4332 Aftertreatment 1 SCR System State 0: Dormant (sleep mode) 1: Preparing dosing readiness 2: Normal dosing operation 3: System error pending 4: Reserved for future assignment by SAE 5: Protect mode against heat (pressure buildup) 6: Protect mode against cold (defreeze) 7: Shutoff (wait for afterrun) 8: Diagnosis (afterrun) 9: Service test mode, dosing allowed 10: Service test mode, dosing not allowed 11-13: Reserved for future assignment by SAE 14: Error 15: Not available		Mask: 000Fh	All
50324	uint16	15997	J1939 States 05			
			Internal		Mask: 8000h	All
		15914	SPN 4991: Charger 1 power line state 0: Disconnected 1: Connected 2: Error 3: Not Available		Mask: 6000h	All
		15913	SPN 4990: Charger 1 state 0: Idling 1: Charging 2: Stand-by 3 - 12: Reserve 13: Battery failure 14: Charger failure 15: Not Available		Mask: 1E00h	All
		15696	HC Evaporation required action(Scania S8)		Mask: 01C0h	All

Modbus-Address	Size	Index	Description	Unit	Scale	Model
			0: No action required 1: Run engine warm 2: Increased idle and heavy exhaust braking 3: Engine stop 4,5: Reserved 6: Error 7: Not Available			
		12048	SPN 5246 Aftertreatment SCR Operator Inducement Severity 0: Driver Warning, Low-Level Inducement, and Severe Inducement Non-Active 1: Inducement Level 1 2: Inducement Level 2 3: Inducement Level 3 4: Inducement Level 4 5: Inducement Level 5 6: Temporary Override of Inducem 7: Not Available / Not Supported		Mask: 0038h	All
		12047	SPN 5245 Aftertreatment Selective Catalytic Reduction Operator Inducement Activ 0: Off - indicates adequate DEF level 1: On solid - indicates low DEF level 2: reserved for SAE assignment 3: reserved for SAE assignment 4: On fast blink (1 Hz) low DEF level (lower than 1) 5: reserved for SAE assignment 6: reserved for SAE assignment 7: not available		Mask: 0007h	All
50325	uint16	15398	DPF Regeneration Countdown Timer(Scania S8)	min	*1	All
50326	uint16	15697	HC Evaporation Progress Countdown Timer(Scania S8)	min	*1	All
50327	uint16	15846	HC Evaporation Action Start Countdown Timer(Scania S8)	min	*1	All
50328	uint16	15900	Time to torque limiting (Scania S8)	h	*1	All
50329	int16	15909	SPN 3216: Aftertreatm.1 NOx intake	ppm	*10	All
50330	int16	15911	SPN 3226: Aftertreatm.1 NOx outlet	ppm	*10	All
50331	uint16	15915	SPN 4992: Charger 1 Output voltage	V	*10	All
50332	int16	15916	SPN 4993: Charger 1 Output Current	A	*10	All

Modbus-Address	Size	Index	Description	Unit	Scale	Model
50333	int16	10362	SPN 1117: Engine Desired Rated Exhaust Oxygen	%	*100	All
50334	int16	10364	SPN 1118: Engine Desired Exhaust Oxygen	%	*100	All
50335	int16	10366	SPN 1119: Engine Actual Exhaust Oxygen	%	*100	All
50336	int16	10368	SPN 1695: Engine Exhaust O2 Sensor Fueling Correction	%	*1	All
50337	int16	10372	SPN 1765: Engine Requested Fuel Valve 1 Position	%	*10	All
50338	int16	10374	SPN 1127: Engine Turbocharger 1 Boost Pressure	kPa	*1	All
50339	int16	10376	SPN 51: Engine Throttle Valve 1 Position 1	%	*10	All
50340	int16	10388	SPN 4765: Aftertreatm. 1 Diesel Oxid. Catalyst Intake Gas Temp	°C	*10	All
50341	int16	10398	SPN 4766: Aftertreatm. 1 Diesel Oxid. Catalyst Outlet Gas Temp	°C	*10	All
50342	int16	16215	J1939 States 06			All
			Internal		Mask: F000h	All
			SPN 97 Water in fuel 0: No water in fuel 1: Water in fuel (LM 14.47) 2,3: not defined		Mask: 0C00h	All
		10370	SPN 1696 Engine Exhaust O2 Sensor Closed Loop Operation 0: not used 1: used 2: Reserve 1 3: Missing (= Don't Care/take no action)		Mask: 0300h	All
		10385	SPN 3240 Aftertreatment 1 Exhaust Dew Point 0: Ok (not exceeded) 1: exceeded 2: error 3: not available		Mask: 00C0h	All
		10383	SPN 3239 Aftertreatment 2 Intake Dew Point 0: Ok (not exceeded) 1: exceeded 2: error 3: not available		Mask: 0030h	All
		10381	SPN 3238 Aftertreatment 1 Exhaust Dew Point 0: Ok (not exceeded) 1: exceeded		Mask: 000Ch	All

9 Appendix

9.2.7 Protocol 5016 (Basic Visualization)

Modbus-Address	Size	Index	Description	Unit	Scale	Model
			2: error 3: not available			
		10379	SPN 3237 Aftertreatment 1 Intake Dew Point 0: Ok (not exceeded) 1: exceeded 2: error 3: not available		Mask: 0003h	All
50343	int16	16216	J1939 States 07 (Only for ECU FPT1 MD1)			
			DEF level inducement 0: not present 1: warning (LM 14.56) 2: moderate (LM 14.57) 3: severe (LM 14.58)		Mask: 6000h	All
			DEF quality inducement 0: not present 1: warning (LM 14.59) 2: moderate (LM 14.60) 3: severe (LM 14.61)		Mask: 1800h	All
			System tampering inducement 0: not present 1: warning (LM 14.53) 2: moderate (LM 14.54) 3: severe (LM 14.55)		Mask: 0600h	All
			Clogging fuel prefilter 0: not clogged 1: clogged (LM 14.52) 2: not available 3: not clogged (to backward compatible)		Mask: 00180h	All
			Clogging fuel filter 0: not clogged 1: clogged (LM 14.51) 2: not available 3: not clogged (to backward compatible)		Mask: 00060h	All
			Low engine oil pressure 0: normal 1: warning (LM 14.50)		Mask: 00018h	All

Modbus-Address	Size	Index	Description	Unit	Scale	Model
			2-3: not defined			
			Coolant temperature 0: no warning 1: prewarning (LM 14.48) 2: warning (LM 14.49) 3-5: not defined		Mask: 0007h	All
50344	int16	17591	SPN 3517: Aftertreatment 1 Diesel Exhaust Fluid Tank Level 2	mm	*10	All
50345	int16		Internal			
50346	int16		Internal			
50347	int16		Internal			
50348	int16		Internal			
50349	int16		Internal			
50350	int16		Internal			
50351	int16		Internal			
50352	int16		Internal			
50353	int16		Internal			
50354	int16		Internal			
50355	int16		Internal			
50356	int16		Internal			
50357	int16		Internal			
50358	int16		Internal			
50359	int16		Internal			
50360	int16		Internal			
50361	int16		Internal			
50362	int16		Internal			
50363	int16		Internal			
50364	int16		Internal			
50365	int16		Internal			
50366	int16		Internal			
50367	int16		Internal			
50368	int16		Internal			
50369	int16		Internal			
Topic Miscellenous						
50370	int16	9202	91.01 AM Internal value 1			All
50371	int16	9203	91.02 AM Internal value 2			All
50372	int16	9204	91.03 AM Internal value 3			All

Modbus-Address	Size	Index	Description	Unit	Scale	Model
50373	int16	9205	91.04 AM Internal value 4			All
50374	int16	9206	91.05 AM Internal value 5			All
50375	int16	9207	91.06 AM Internal value 6			All
50376	int16	9208	91.07 AM Internal value 7			All
50377	int16	9209	91.08 AM Internal value 8			All
50378	int16	9210	91.09 AM Internal value 9			All
50379	int16	9211	91.10 AM Internal value 10			All
50380	int16	9212	91.11 AM Internal value 11			All
50381	int16	9213	91.12 AM Internal value 12			All
50382	int16	9214	91.13 AM Internal value 13			All
50383	int16	9215	91.14 AM Internal value 14			All
50384	int16		Internal			
50385	int16		Internal			
50386	uint16	4096	BITGROUP ControlBits 17			
		4026	Monitored Number of easYgen communicating		Mask FF00h	All
		4027	Number of easYgens currently communicating		Mask 00FFh	All
50387	uint16	4097	BITGROUP ControlBits 18			
		4028	Monitored Number of LS5 communicating		Mask FF00h	EG3500XT-P1 EG3500XT-P2
		4029	Number of LS5 currently communicating		Mask 00FFh	EG3500XT-P1 EG3500XT-P2
50388	uint16	4098	BITLIST Device number of missing LS-5 (33-48)			
			LS-5 Device Nr. 48		Mask 8000h	EG3500XT-P1 EG3500XT-P2
			LS-5 Device Nr. 47		Mask 4000h	EG3500XT-P1 EG3500XT-P2
			LS-5 Device Nr. 46		Mask 2000h	EG3500XT-P1 EG3500XT-P2
			LS-5 Device Nr. 45		Mask 1000h	EG3500XT-P1 EG3500XT-P2
			LS-5 Device Nr. 44		Mask 0800h	EG3500XT-P1 EG3500XT-P2
			LS-5 Device Nr. 43		Mask 0400h	EG3500XT-P1 EG3500XT-P2
			LS-5 Device Nr. 42		Mask 0200h	EG3500XT-P1

Modbus-Address	Size	Index	Description	Unit	Scale	Model
						EG3500XT-P2
			LS-5 Device Nr. 41		Mask 0100h	EG3500XT-P1 EG3500XT-P2
			LS-5 Device Nr. 40		Mask 0080h	EG3500XT-P1 EG3500XT-P2
			LS-5 Device Nr. 39		Mask 0040h	EG3500XT-P1 EG3500XT-P2
			LS-5 Device Nr. 38		Mask 0020h	EG3500XT-P1 EG3500XT-P2
			LS-5 Device Nr. 37		Mask 0010h	EG3500XT-P1 EG3500XT-P2
			LS-5 Device Nr. 36		Mask 0008h	EG3500XT-P1 EG3500XT-P2
			LS-5 Device Nr. 35		Mask 0004h	EG3500XT-P1 EG3500XT-P2
			LS-5 Device Nr. 34		Mask 0002h	EG3500XT-P1 EG3500XT-P2
			LS-5 Device Nr. 33		Mask 0001h	EG3500XT-P1 EG3500XT-P2
50389	uint16	4099	BITLIST Device number of missing LS-5 (49-64)			
			LS-5 Device Nr. 64		Mask 8000h	EG3500XT-P1 EG3500XT-P2
			LS-5 Device Nr. 63		Mask 4000h	EG3500XT-P1 EG3500XT-P2
			LS-5 Device Nr. 62		Mask 2000h	EG3500XT-P1 EG3500XT-P2
			LS-5 Device Nr. 61		Mask 1000h	EG3500XT-P1 EG3500XT-P2
			LS-5 Device Nr. 60		Mask 0800h	EG3500XT-P1 EG3500XT-P2
			LS-5 Device Nr. 59		Mask 0400h	EG3500XT-P1 EG3500XT-P2
			LS-5 Device Nr. 58		Mask 0200h	EG3500XT-P1

Modbus-Address	Size	Index	Description	Unit	Scale	Model
						EG3500XT-P2
			LS-5 Device Nr. 57		Mask 0100h	EG3500XT-P1 EG3500XT-P2
			LS-5 Device Nr. 56		Mask 0080h	EG3500XT-P1 EG3500XT-P2
			LS-5 Device Nr. 55		Mask 0040h	EG3500XT-P1 EG3500XT-P2
			LS-5 Device Nr. 54		Mask 0020h	EG3500XT-P1 EG3500XT-P2
			LS-5 Device Nr. 53		Mask 0010h	EG3500XT-P1 EG3500XT-P2
			LS-5 Device Nr. 52		Mask 0008h	EG3500XT-P1 EG3500XT-P2
			LS-5 Device Nr. 51		Mask 0004h	EG3500XT-P1 EG3500XT-P2
			LS-5 Device Nr. 50		Mask 0002h	EG3500XT-P1 EG3500XT-P2
			LS-5 Device Nr. 49		Mask 0001h	EG3500XT-P1 EG3500XT-P2
50390	int16	181	Phase angle busbar1-generator L1-L2	°	*10	All
50391	int16	184	Phase angle mains-busbar1 L1-L2	°	*10	All
50392	int16	4641	Delta voltage busbar1-generator	%	*10	All
50393	int16	4640	Delta frequency busbar1-generator	Hz	*100	All
50394	int16	4607	Phase angle compensated generator-busbar1 L1-L2	°	*10	All
50395	int16	139	Generator power factor L1		*1000	All
50396	int16	203	Generator power factor L2		*1000	All
50397	int16	204	Generator power factor L3		*1000	All
50398	int16	8850	Voltage increase monitored value	%	*100	All
50399	int16	4606	Phase angle compensated mains-busbar1 L1-L2	°	*10	All
50400	int16	4211	BITLIST Free alarms 17- 32 active			
			Free alarm 32 active		Mask: 8000h	All
			Free alarm 31 active		Mask: 4000h	All
			Free alarm 30 active		Mask: 2000h	All
			Free alarm 29 active		Mask: 1000h	All

Modbus-Address	Size	Index	Description	Unit	Scale	Model
			Free alarm 28 active		Mask: 0800h	All
			Free alarm 27 active		Mask: 0400h	All
			Free alarm 26 active		Mask: 0200h	All
			Free alarm 25 active		Mask: 0100h	All
			Free alarm 24 active		Mask: 0080h	All
			Free alarm 23 active		Mask: 0040h	All
			Free alarm 22 active		Mask: 0020h	All
			Free alarm 21 active		Mask: 0010h	All
			Free alarm 20 active		Mask: 0008h	All
			Free alarm 19 active		Mask: 0004h	All
			Free alarm 18 active		Mask: 0002h	All
			Free alarm 17 active		Mask: 0001h	All
50401	int16	10316	BITLIST Free alarms 17-32 latched			
			Free alarm 32 latched		Mask: 8000h	All
			Free alarm 31 latched		Mask: 4000h	All
			Free alarm 20 latched		Mask: 2000h	All
			Free alarm 29 latched		Mask: 1000h	All
			Free alarm 28 latched		Mask: 0800h	All
			Free alarm 27 latched		Mask: 0400h	All
			Free alarm 26 latched		Mask: 0200h	All
			Free alarm 25 latched		Mask: 0100h	All
			Free alarm 24 latched		Mask: 0080h	All
			Free alarm 23 latched		Mask: 0040h	All
			Free alarm 22 latched		Mask: 0020h	All
			Free alarm 21 latched		Mask: 0010h	All
			Free alarm 20 latched		Mask: 0008h	All
			Free alarm 19 latched		Mask: 0004h	All
			Free alarm 18 latched		Mask: 0002h	All
			Free alarm 17 latched		Mask: 0001h	All
50402	int16		Internal			
50403	int16		Internal			
50404	int16		Internal			
50405	int16		Internal			
50406	int16		Internal			
50407	int16		Internal			
50408	int16		Internal			
50409	int16		Internal			

Modbus-Address	Size	Index	Description	Unit	Scale	Model
Int32 (Long)						
Topic AC Generator and Busbar values						
50410	int32	135	Total gen. active power	kW	*1000	All
50412	int32	136	Total gen. reactive power	kvar	*1000	All
50414	int32	137	Total gen. apparent power	kVA	*1000	All
50416	uint32	170	Average Gen. Wye-Voltage	V	*10	All
50418	uint32	171	Average Gen. Delta-Voltage	V	*10	All
50420	int32	216	Average Busbar Delta-Voltage	V	*10	All
50422	int32	185	Av. Gen. Current	A	*1000	All
50424	int32	111	Gen. current L1	A	*1000	All
50426	int32	112	Gen. current L2	A	*1000	All
50428	int32	113	Gen. current L3	A	*1000	All
50430	int32	161	Meas. ground current	A	*1000	All
50432	int32	159	Calculated ground current	A	*1000	All
50434	int32	108	Gen. voltage L1-L2	V	*10	All
50436	int32	109	Gen. voltage L2-L3	V	*10	All
50438	int32	110	Gen. voltage L3-L1	V	*10	All
50440	int32	114	Gen. voltage L1-N	V	*10	All
50442	int32	115	Gen. voltage L2-N	V	*10	All
50444	int32	116	Gen. voltage L3-N	V	*10	All
50446	int32	125	Gen. active power L1	kW	*1000	All
50448	int32	126	Gen. active power L2	kW	*1000	All
50450	int32	127	Gen. active power L3	kW	*1000	All
50452	int32	182	Busbar 1: voltage L1-L2	V	*10	All
50454	uint32	2520	Gen. real energy	MWh	*100	All
50456	uint32	2522	Gen. positive reactive energy	Mvarh	*100	All
50458	uint32	2568	Gen. hours of operation	h	*100	All
50460	int32	5542	Setpoint active power	kW	*10	All
50462	int32	5657	Setpoint voltage	V	*1	All
50464	int32	234	Average Busbar Wye-Voltage	V	*10	All
50466	int32	189	Busbar 1: voltage L2-L3	V	*10	EG3500XT-P1 EG3500XT-P2
50468	int32	193	Busbar 1: voltage L3-L1	V	*10	EG3500XT-P1 EG3500XT-P2
50470	uint32	2526	Gen. negative reactive energy	Mvarh	*100	All
Topic AC Mains values						
50472	int32	140	Total mains active power	kW	*1000	All

Modbus-Address	Size	Index	Description	Unit	Scale	Model
50474	int32	150	Total mains reactive power	kvar	*1000	All
50476	uint32	173	Average Mains Wye-Voltage	V	*10	All
50478	uint32	174	Av. Mains Delta-Voltage	V	*10	All
50480	uint32	207	Av. Mains Current	A	*1000	All
50482	int32	134	Mains current L1	A	*1000	All
50484	int32		Internal			
50486	int32		Internal			
50488	int32	118	Mains voltage L1-L2	V	*10	All
50490	int32	119	Mains voltage L2-L3	V	*10	All
50492	int32	120	Mains voltage L3-L1	V	*10	All
50494	int32	121	Mains voltage L1-N	V	*10	All
50496	int32	122	Mains voltage L2-N	V	*10	All
50498	int32	123	Mains voltage L3-N	V	*10	All
Topic AC System values						
50500	int32	217	Reserve real power in system (valid if LDSS is on)	kW	*1	All
50502	int32	218	Real power in system (valid if LDSS is on)	kW	*1	All
50504	int32	219	Nominal real power in system (valid if LDSS is on)	kW	*1	All
50506	int32	10360	05.70 Active power set point ramped	kW	*10	All
50508	int32	10361	05.92 Reactive power set point ramped	kvar	*10	All
50510	int32		Internal			
Topic Engine Management						
Subtopic Active Diagnostic Trouble Code (DM1) 1-10 (All SPNs)						
50512	uint32	15400	SPN of 1. entry		full 19 bits of SPN	All
50514	uint32	15403	SPN of 2. entry		full 19 bits of SPN	All
50516	uint32	15406	SPN of 3. entry		full 19 bits of SPN	All
50518	uint32	15409	SPN of 4. entry		full 19 bits of SPN	All
50520	uint32	15412	SPN of 5. entry		full 19 bits of SPN	All
50522	uint32	15415	SPN of 6. entry		full 19 bits of SPN	All
50524	uint32	15419	SPN of 7. entry		full 19 bits of SPN	All
50526	uint32	15422	SPN of 8. entry		full 19 bits of SPN	All
50528	uint32	15425	SPN of 9. entry		full 19 bits of SPN	All

Modbus-Address	Size	Index	Description	Unit	Scale	Model
50530	uint32	15428	SPN of 10. entry		full 19 bits of SPN	All
Subtopic Values						
50532	uint32	15201	Total engine hours (j1939-HOURS, SPN 247)	h	*1	All
50534	uint32	2580	Period of use counter	h	*100	All
50536	uint32	15319	Engine Total Fuel Used (SPN250)	L	*10	All
50538	int32		Internal			
50540	int32		Internal			
Topic LS5						
50542	int32	267	Average LSx Delta Mains voltage L-L	V	*10	EG3500XT-P1 EG3500XT-P2
50544	int32	268	Average LSx Wye Mains voltage L-N	V	*10	EG3500XT-P1 EG3500XT-P2
50546	int32	269	Active power LSx (Active mains power in own segment)	kW	*1000	EG3500XT-P1 EG3500XT-P2
50548	int32	270	Reactive power LSx (Reactive mains power in own segment)	kvar	*1000	EG3500XT-P1 EG3500XT-P2
50550	int32		Internal			
50552	int32		Internal			
50554	int32		Internal			
50556	int32		Internal			
50558	int32		Internal			
50560	int32		Internal			
Topic Miscellenous						
50562	int32	231	Busbar Voltage L1-N	V	*10	EG3500XT-P2
50564	int32	232	Busbar Voltage L2-N	V	*10	EG3500XT-P2
50566	int32	233	Busbar Voltage L3-N	V	*10	EG3500XT-P2
50568	int32	5646	Setpoint reactive power	kvar	*10	All
50570	int32	9698	91.15 AM Internal value 15 (long)			All
50572	int32	9702	91.16 AM Internal value 16 (long)			All
50574	int32	155	Generator current slave pointer L1	A	*1000	All
50576	int32	156	Generator current slave pointer L2	A	*1000	All
50578	int32	157	Generator current slave pointer L3	A	*1000	All
50580	int32	128	Generator reactive power L1	kvar	*1000	All
50582	int32	129	Generator reactive power L2	kvar	*1000	All
50584	int32	130	Generator reactive power L3	kvar	*1000	All
50586	int32	131	Generator apparent power L1	kVA	*1000	All

Modbus-Address	Size	Index	Description	Unit	Scale	Model
50588	int32	132	Generator apparent power L2	kVA	*1000	All
50590	int32	133	Generator apparent power L3	kVA	*1000	All
50592	int32	152	Mains total apparent power	kVA	*1000	All
50594	int32	158	Mains current slave pointer L1	A	*1000	All
50596	int32		Internal			
50598	int32		Internal			
50600	uint32	12043	SPN 3721 DPF1 time since regeneration	s	*1	All

9.2.8 Protocol 5017 (Alarm Values Visualization)

CAN Mux	CAN Byte	Size	Index	Description	Unit	Scale	Model
0	1-2	uint16		Protocol-ID, always 5017			
Subtopic Generator							
0	3-4	uint16	4161	BITLIST Alarms Generator active			
				Gen.overfreq. 1		Mask: 8000h	All
				Gen.overfreq. 2		Mask: 4000h	All
				Gen.underfreq. 1		Mask: 2000h	All
				Gen.underfreq. 2		Mask: 1000h	All
				Gen. overvolt. 1		Mask: 0800h	All
				Gen. overvolt. 2		Mask: 0400h	All
				Gen. undervolt. 1		Mask: 0200h	All
				Gen. undervolt. 2		Mask: 0100h	All
				Gen. overcurr. 1		Mask: 0080h	All
				Gen. overcurr. 2		Mask: 0040h	All
				Gen. overcurr. 3		Mask: 0020h	All
				Gen. Rv/Rd pow.1		Mask: 0010h	All
				Gen. Rv/Rd pow.2		Mask: 0008h	All
				Gen. Overload IOP 1		Mask: 0004h	All
				Gen. Overload IOP 2		Mask: 0002h	All
				Busbar phase rotation mismatch		Mask: 0001h	EG3500XT-P2
0	5-6	uint16	10134	BITLIST Alarms Generator latched (unacknowledged)			
				06.01 Generator over frequency 1 latched		Mask: 8000h	All
				06.02 Generator over frequency 2 latched		Mask: 4000h	All
				06.03 Generator under frequency 1 latched		Mask: 2000h	All
				06.04 Generator under frequency 2 latched		Mask: 1000h	All
				06.05 Generator over voltage 1 latched		Mask: 0800h	All

9 Appendix

9.2.8 Protocol 5017 (Alarm Values Visualization)

CAN Mux	CAN Byte	Size	Index	Description	Unit	Scale	Model
				06.06 Generator over voltage 2 latched		Mask: 0400h	All
				06.07 Generator under voltage 1 latched		Mask: 0200h	All
				06.08 Generator under voltage 2 latched		Mask: 0100h	All
				06.09 Generator over current 1 latched		Mask: 0080h	All
				06.10 Generator over current 2 latched		Mask: 0040h	All
				06.11 Generator over current 3 latched		Mask: 0020h	All
				06.12 Reverse / reduced power 1 latched		Mask: 0010h	All
				06.13 Reverse / reduced power 2 latched		Mask: 0008h	All
				06.14 Generator overload IOP 1 latched		Mask: 0004h	All
				06.15 Generator overload IOP 2 latched		Mask: 0002h	All
				06.34 Busbar phase rotation mismatch		Mask: 0001h	EG3500XT-P2
1	1-2	uint16	4163	BITLIST Alarms Generator 1 active (reserved)			
				Unbal. load 1		Mask: 8000h	All
				Unbal. load 2		Mask: 4000h	All
				Gen. Asymmetry		Mask: 2000h	All
				Ground fault 1		Mask: 1000h	All
				Ground fault 2		Mask: 0800h	All
				Gen. phase rot. misw.		Mask: 0400h	All
				Gen act.pwr mismatch		Mask: 0200h	All
				Gen. unloading fault		Mask: 0100h	All
				Inv.time ov.curr.		Mask: 0080h	All
				Operating range failed,		Mask: 0040h	All
				Gen. Overload MOP 1		Mask: 0020h	All
				Gen. Overload MOP 2		Mask: 0010h	All
				Gen.Power Factor lagging 1		Mask: 0008h	All
				Gen.Power Factor lagging 2		Mask: 0004h	All
				Gen.Power Factor leading 1		Mask: 0002h	All
				Gen.Power Factor leading 2		Mask: 0001h	All
1	3-4	uint16	10138	BITLIST Alarms Generator 1 latched (unacknowledged)			
				06.16 Generator unbalanced load 1 latched		Mask: 8000h	All
				06.17 Generator unbalanced load 2 latched		Mask: 4000h	All
				06.18 Generator voltage asymmetry latched		Mask: 2000h	All
				06.19 Ground fault 1 latched		Mask: 1000h	All
				06.20 Ground fault 2 latched		Mask: 0800h	All
				06.21 Gen. Phase Rotation mismatch Latched		Mask: 0400h	All
				06.29 Gen. active power mismatch Latched		Mask: 0200h	All
				06.30 Generator unloading mismatch Latched		Mask: 0100h	All

CAN Mux	CAN Byte	Size	Index	Description	Unit	Scale	Model
				06.22 Inverse time over current Latched		Mask: 0080h	All
				06.31 Operating Range failed latched		Mask: 0040h	All
				06.23 Generator overload MOP 1 latched		Mask: 0020h	All
				06.24 Generator overload MOP 2 latched		Mask: 0010h	All
				06.25 Gen.Power Factor lagging 1 latched		Mask: 0008h	All
				06.26 Gen.Power Factor lagging 2 latched		Mask: 0004h	All
				06.27 Gen.Power Factor leading 1 latched		Mask: 0002h	All
				06.28 Gen.Power Factor leading 2 latched		Mask: 0001h	All
1	5-6	uint16	10131	BITLIST Alarm classes latched (unacknowledged)			
				01.11 New Alarm triggered		Mask: 8000h	All
				internal		Mask: 4000h	
				internal		Mask: 2000h	
				internal		Mask: 1000h	
				internal		Mask: 0800h	
				internal		Mask: 0400h	
				internal		Mask: 0200h	
				internal		Mask: 0100h	
				internal		Mask: 0080h	
				internal		Mask: 0040h	
				01.06 Alarm class F latched		Mask: 0020h	All
				01.05 Alarm class E latched		Mask: 0010h	All
				01.04 Alarm class D latched		Mask: 0008h	All
				01.03 Alarm class C latched		Mask: 0004h	All
				01.02 Alarm class B latched		Mask: 0002h	All
				01.01 Alarm class A latched		Mask: 0001h	All
Subtopic Mains							
2	1-2	uint16	4188	BITLIST Alarms Mains active			
				Mains ov.freq. 1		Mask: 8000h	All
				Mains ov.freq. 2		Mask: 4000h	All
				Mains un.freq. 1		Mask: 2000h	All
				Mains un.freq. 2		Mask: 1000h	All
				Mains ov.volt. 1		Mask: 0800h	All
				Mains ov.volt. 2		Mask: 0400h	All
				Mains un.volt. 1		Mask: 0200h	All
				Mains un.volt. 2		Mask: 0100h	All
				Mains phaseshift		Mask: 0080h	All
				Mains decoupling		Mask: 0040h	All

9 Appendix

9.2.8 Protocol 5017 (Alarm Values Visualization)

CAN Mux	CAN Byte	Size	Index	Description	Unit	Scale	Model
				Mains AC Wiring		Mask: 0020h	All
				Internal		Mask: 0010h	
				Internal		Mask: 0008h	
				Mains Phase rotation mismatch		Mask: 0004h	All
				Internal		Mask: 0002h	
				Internal		Mask: 0001h	
2	3-4	uint16	10135	BITLIST Alarms Mains latched (unacknowledged)			
				07.06 Mains over frequency 1 latched		Mask: 8000h	All
				07.07 Mains over frequency 2 latched		Mask: 4000h	All
				07.08 Mains under frequency 1 latched		Mask: 2000h	All
				07.09 Mains under frequency 2 latched		Mask: 1000h	All
				07.10 Mains over voltage 1 latched		Mask: 0800h	All
				07.11 Mains over voltage 2 latched		Mask: 0400h	All
				07.12 Mains under voltage 1 latched		Mask: 0200h	All
				07.13 Mains under voltage 2 latched		Mask: 0100h	All
				07.14 Mains Phase shift latched		Mask: 0080h	All
				07.25 Mains decoupling latched		Mask: 0040h	All
				07.32 Mains AC Wiring		Mask: 0020h	All
				Internal		Mask: 0010h	
				Internal		Mask: 0008h	
				07.05 Mains Phase rotation mismatch latched		Mask: 0004h	All
				Internal		Mask: 0002h	
				Internal		Mask: 0001h	
2	5-6	uint16		Internal			
3	1-2	uint16	4187	BITLIST Alarms Mains 1 active			
				Mains import power 1		Mask: 8000h	All
				Mains import power 2		Mask: 4000h	All
				Mains export power 1		Mask: 2000h	All
				Mains export power 2		Mask: 1000h	All
				Mains overexcited 1		Mask: 0800h	All
				Mains overexcited 2		Mask: 0400h	All
				Mains underexcited 1		Mask: 0200h	All
				Mains underexcited 2		Mask: 0100h	All
				Mains df/dt		Mask: 0080h	All
				Mns act.pwr mismatch		Mask: 0040h	All
				Mains. Time dep. Voltage		Mask: 0020h	All
				Internal		Mask: 0010h	

CAN Mux	CAN Byte	Size	Index	Description	Unit	Scale	Model
				Mains slow voltage increase (10 min)		Mask: 0008h	All
				Internal		Mask: 0004h	
				Mains QV Monitoring step 1		Mask: 0002h	All
				Mains QV Monitoring step 2		Mask: 0001h	All
3	3-4	uint16	10278	BITLIST Alarms Mains 1 latched (unacknowledged)			
				07.21 Mains import power 1 latched		Mask: 8000h	All
				07.22 Mains import power 2 latched		Mask: 4000h	All
				07.23 Mains export power 1 latched		Mask: 2000h	All
				07.24 Mains export power 2 latched		Mask: 1000h	All
				07.17 Mains PF lagging 1 latched		Mask: 0800h	All
				07.18 Mains PF lagging 2 latched		Mask: 0400h	All
				07.19 Mains PF leading 1 latched		Mask: 0200h	All
				07.20 Mains PF leading 2 latched		Mask: 0100h	All
				07.15 Mains df/dt latched		Mask: 0080h	All
				07.16 Mains active power mismatch latched		Mask: 0040h	All
				07.28 Mains Time-dep. Voltage (FRT) latched		Mask: 0020h	All
				Internal		Mask: 0010h	
				07.27 Mains slow voltage increase (10 min)		Mask: 0008h	All
				Internal		Mask: 0004h	
				07.29 QU Monitoring step 1 tripped		Mask: 0002h	All
				07.30 QU Monitoring step 2 tripped		Mask: 0001h	All
3	5-6	uint16		Internal			
Subtopic Engine							
4	1-2	uint16	4167	BITLIST Alarms 1 active			
				Overspeed 1		Mask: 8000h	All
				Overspeed 2		Mask: 4000h	All
				Underspeed 1		Mask: 2000h	All
				Underspeed 2		Mask: 1000h	All
				Unintended stop		Mask: 0800h	All
				Speed det. Alarm		Mask: 0400h	All
				Shutdwn malfunct.		Mask: 0200h	All
				GCB fail to close		Mask: 0100h	All
				GCB fail to open		Mask: 0080h	All
				MCB fail to close		Mask: 0040h	All
				MCB fail to open		Mask: 0020h	All
				CAN-Fault J1939		Mask: 0010h	All
				Start fail		Mask: 0008h	All

9 Appendix

9.2.8 Protocol 5017 (Alarm Values Visualization)

CAN Mux	CAN Byte	Size	Index	Description	Unit	Scale	Model
				Mainten. days exceeded		Mask: 0004h	All
				Mainten. hours exceeded		Mask: 0002h	All
				CANopen error at CAN Interface 1		Mask: 0001h	All
4	3-4	uint16	10133	BITLIST Alarms 1 latched (unacknowledged)			
				05.01 Engine Over speed 1 latched		Mask: 8000h	All
				05.02 Engine Over speed 2 latched		Mask: 4000h	All
				05.03 Engine under speed 1 latched		Mask: 2000h	All
				05.04 Engine under speed 2 latched		Mask: 1000h	All
				05.05 Unintended stop detected latched		Mask: 0800h	All
				05.07 Speed detection alarm latched		Mask: 0400h	All
				05.06 Shutdown malfunction detected latched		Mask: 0200h	All
				08.05 GCB fail to close latched		Mask: 0100h	All
				08.06 GCB fail to open latched		Mask: 0080h	All
				08.07 MCB fail to close latched		Mask: 0040h	All
				08.08 MCB fail to open latched		Mask: 0020h	All
				08.10 General CAN-J1939 fault latched		Mask: 0010h	All
				05.08 Start fail detected latched		Mask: 0008h	All
				05.09 Maintenance days exceeded latched		Mask: 0004h	All
				05.10 Maintenance hours exceeded latched		Mask: 0002h	All
				08.18 CANopen error at CAN Interface 1		Mask: 0001h	All
4	5-6	uint16	4193	BITLIST Alarms 3 active			
				GGB fail to close		Mask: 8000h	EG3500XT-P1 EG3500XT-P2
				GGB fail to open		Mask: 4000h	EG3500XT-P1 EG3500XT-P2
				Missing easYgen		Mask: 2000h	All
				Missing LSx		Mask: 1000h	EG3500XT-P1 EG3500XT-P2
				Cylinder temperature level 1		Mask: 0800h	All
				Cylinder temperature level 2		Mask: 0400h	All
				Cylinder temperature wire break		Mask: 0200h	All
				Pole slip		Mask: 0100h	All
				Syst.update LSx		Mask: 0080h	EG3500XT-P1 EG3500XT-P2
				Syst.update easYgen		Mask: 0040h	All
				Gen.AC Wiring		Mask: 0020h	All

CAN Mux	CAN Byte	Size	Index	Description	Unit	Scale	Model
				Busbar1 AC Wiring		Mask: 0010h	EG3500XT-P2
				Internal		Mask: 0008h	
				Internal		Mask: 0004h	
				Internal		Mask: 0002h	
				Internal		Mask: 0001h	
5	1-2	uint16	4169	BITLIST Alarms 2 active			
				GCB sync. Timeout		Mask: 8000h	All
				MCB sync. Timeout		Mask: 4000h	All
				GGB sync. Timeout		Mask: 2000h	EG3500XT-P1 EG3500XT-P2
				Charge alt. low voltage (D+)		Mask: 1000h	All
				Phase rotation mismatch		Mask: 0800h	All
				CPU overload R1 trip		Mask: 0400h	All
				MCB failure 50BF		Mask: 0200h	All
				GCB failure 50BF		Mask: 0100h	All
				ECU Protect alarm		Mask: 0080h	All
				ECU Emission alarm		Mask: 0040h	All
				CANopen error at CAN Interface 2		Mask: 0020h	All
				Parameter Alignment		Mask: 0010h	All
				Missing easYgen		Mask: 0008h	All
				MCB plausibility		Mask: 0004h	All
				Red stop lamp DM1		Mask: 0002h	All
				Amber warning lamp DM1		Mask: 0001h	All
5	3-4	uint16	10149	BITLIST Alarms 2 latched (unacknowledged)			
				08.30 GCB syn. timeout latched		Mask: 8000h	All
				08.31 MCB syn. timeout latched		Mask: 4000h	All
				08.32 GGB Timeout latched		Mask: 2000h	EG3500XT-P1 EG3500XT-P2
				05.11 Charge alt. low voltage (D+) latched		Mask: 1000h	All
				operating range failure 12		Mask: 0800h	All
				08.45 CPU overload R1 trip		Mask: 0400h	All
				08.47 MCB failure 50BF latched		Mask: 0200h	All
				08.46 GCB failure 50BF latched		Mask: 0100h	All
				05.22 ECU Protect alarm latched		Mask: 0080h	All
				05.23 ECU Emission alarm latched		Mask: 0040h	All
				08.19 CANopen error at CAN Interface 2		Mask: 0020h	All
				08.16 Parameter Alignment latched		Mask: 0010h	All

CAN Mux	CAN Byte	Size	Index	Description	Unit	Scale	Model
				08.27 Missing easYgen latched		Mask: 0008h	All
				08.48 MCB plausibility latched		Mask: 0004h	All
				05.13 Red stop lamp latched		Mask: 0002h	All
				05.14 Amber warning lamp latched		Mask: 0001h	All
5	5-6	uint16	10190	BITLIST Alarms 3 latched (unacknowledged)			
				08.34 GGB fail to close latched		Mask: 8000h	EG3500XT-P1 EG3500XT-P2
				08.35 GGB fail to open latched		Mask: 4000h	EG3500XT-P1 EG3500XT-P2
				08.27 Missing easYgen		Mask: 2000h	All
				08.28 Missing LSx		Mask: 1000h	EG3500XT-P1 EG3500XT-P2
				05.18 Cylinder temperature level 1		Mask: 0800h	All
				05.19 Cylinder temperature level 2		Mask: 0400h	All
				05.20 Cylinder temperature wire break		Mask: 0200h	All
				06.35 Pole slip		Mask: 0100h	All
				08.44 Syst.update LSx		Mask: 0080h	EG3500XT-P1 EG3500XT-P2
				08.43 Syst.update easYgen		Mask: 0040h	All
				06.32 Gen.AC Wiring		Mask: 0020h	All
				06.33 Busbar1 AC Wiring		Mask: 0010h	EG3500XT-P1 EG3500XT-P2
				Internal		Mask: 0008h	
				Internal		Mask: 0004h	
				Internal		Mask: 0002h	
				Internal		Mask: 0001h	
Subtopic GAP Alarms							
6	1-2	uint16	5197	BITLIST Alarms GAP active			
				LS interf.redundancy		Mask: 8000h	EG3500XT-P1 EG3500XT-P2
				Internal		Mask: 4000h	All
				Free alarm 4		Mask: 2000h	All
				Free alarm 3		Mask: 1000h	All
				Free alarm 2		Mask: 0800h	All
				Free alarm 1		Mask: 0400h	All
				Max. starts per time		Mask: 0200h	K36

CAN Mux	CAN Byte	Size	Index	Description	Unit	Scale	Model
				Neutral contactor failure		Mask: 0100h	All
				Decoupling GCB<->MCB		Mask: 0080h	All
				Meas.difference 4105 VDE-AR-N 4105		Mask: 0040h	All
				Parameter alignment VDE-AR-N 4105		Mask: 0020h	All
				Missing member VDE-AR-N 4105		Mask: 0010h	All
				Busbar monitoring		Mask: 0008h	All
				Plausibility GCB feedback		Mask: 0004h	MARINE
				Reactive load sharing mismatch		Mask: 0002h	All
				Active load sharing mismatch		Mask: 0001h	All
6	3-4	uint16	10286	BITLIST Alarms GAP latched (unacknowledged)			
				08.53 LS interf.redundancy latched		Mask: 8000h	EG3500XT-P1 EG3500XT-P2
				Internal		Mask: 4000h	All
				16.04 Free alarm 4 latched		Mask: 2000h	All
				16.03 Free alarm 3 latched		Mask: 1000h	All
				16.02 Free alarm 2 latched		Mask: 0800h	All
				16.01 Free alarm 1 latched		Mask: 0400h	All
				05.21 Max. starts per time		Mask: 0200h	K36
				17.09 Neutral contactor reply mismatch latched		Mask: 0100h	All
				17.08 Decoupling GCB<->MCB latched		Mask: 0080h	All
				17.07 Meas.difference 4105 VDE-AR-N 4105 latched		Mask: 0040h	All
				17.06 Parameter alignment VDE-AR-N 4105 latched		Mask: 0020h	All
				17.05 Missing member VDE-AR-N 4105 latched		Mask: 0010h	All
				08.22 Busbar monitoring latched		Mask: 0008h	All
				08.21 Feedback GCB mismatch latched		Mask: 0004h	MARINE
				17.02 Reactive load share mismatch latched		Mask: 0002h	All
				17.01 Active load share mismatch latched		Mask: 0001h	All
6	5-6	uint16		Internal			
Subtopic Flexible Thresholds							
7	1-2	uint16	4175	BITLIST Alarms Flexible thresholds 1-16 active			
				Alarm flexible limit 16		Mask: 8000h	All
				Alarm flexible limit 15		Mask: 4000h	All
				Alarm flexible limit 14		Mask: 2000h	All
				Alarm flexible limit 13		Mask: 1000h	All

9 Appendix

9.2.8 Protocol 5017 (Alarm Values Visualization)

CAN Mux	CAN Byte	Size	Index	Description	Unit	Scale	Model
				Alarm flexible limit 12		Mask: 0800h	All
				Alarm flexible limit 11		Mask: 0400h	All
				Alarm flexible limit 10		Mask: 0200h	All
				Alarm flexible limit 9		Mask: 0100h	All
				Alarm flexible limit 8		Mask: 0080h	All
				Alarm flexible limit 7		Mask: 0040h	All
				Alarm flexible limit 6		Mask: 0020h	All
				Alarm flexible limit 5		Mask: 0010h	All
				Alarm flexible limit 4		Mask: 0008h	All
				Alarm flexible limit 3		Mask: 0004h	All
				Alarm flexible limit 2		Mask: 0002h	All
				Alarm flexible limit 1		Mask: 0001h	All
7	3-4	uint16	10279	BITLIST Alarms Flexible thresholds 1-16 latched (unacknowledged)			
				15.16 Flexible limit 16 latched		Mask: 8000h	All
				15.15 Flexible limit 15 latched		Mask: 4000h	All
				15.14 Flexible limit 14 latched		Mask: 2000h	All
				15.13 Flexible limit 13 latched		Mask: 1000h	All
				15.12 Flexible limit 12 latched		Mask: 0800h	All
				15.11 Flexible limit 11 latched		Mask: 0400h	All
				15.10 Flexible limit 10 latched		Mask: 0200h	All
				15.09 Flexible limit 9 latched		Mask: 0100h	All
				15.08 Flexible limit 8 latched		Mask: 0080h	All
				15.07 Flexible limit 7 latched		Mask: 0040h	All
				15.06 Flexible limit 6 latched		Mask: 0020h	All
				15.05 Flexible limit 5 latched		Mask: 0010h	All
				15.04 Flexible limit 4 latched		Mask: 0008h	All
				15.03 Flexible limit 3 latched		Mask: 0004h	All
				15.02 Flexible limit 2 latched		Mask: 0002h	All
				15.01 Flexible limit 1 latched		Mask: 0001h	All
7	5-6	uint16		Internal			
8	1-2	uint16	4177	BITLIST Alarms Flexible thresholds 17-32 active			
				Alarm flexible limit 32		Mask: 8000h	All
				Alarm flexible limit 31		Mask: 4000h	All
				Alarm flexible limit 30		Mask: 2000h	All
				Alarm flexible limit 29		Mask: 1000h	All
				Alarm flexible limit 28		Mask: 0800h	All

CAN Mux	CAN Byte	Size	Index	Description	Unit	Scale	Model
				Alarm flexible limit 27		Mask: 0400h	All
				Alarm flexible limit 26		Mask: 0200h	All
				Alarm flexible limit 25		Mask: 0100h	All
				Alarm flexible limit 24		Mask: 0080h	All
				Alarm flexible limit 23		Mask: 0040h	All
				Alarm flexible limit 22		Mask: 0020h	All
				Alarm flexible limit 21		Mask: 0010h	All
				Alarm flexible limit 20		Mask: 0008h	All
				Alarm flexible limit 19		Mask: 0004h	All
				Alarm flexible limit 18		Mask: 0002h	All
				Alarm flexible limit 17		Mask: 0001h	All
8	3-4	uint16	10280	BITLIST Alarms Flexible thresholds 17-32 latched (unacknowledged)			
				15.32 Flexible limit 32 latched		Mask: 8000h	All
				15.31 Flexible limit 31 latched		Mask: 4000h	All
				15.30 Flexible limit 30 latched		Mask: 2000h	All
				15.29 Flexible limit 29 latched		Mask: 1000h	All
				15.28 Flexible limit 28 latched		Mask: 0800h	All
				15.27 Flexible limit 27 latched		Mask: 0400h	All
				15.26 Flexible limit 26 latched		Mask: 0200h	All
				15.25 Flexible limit 25 latched		Mask: 0100h	All
				15.24 Flexible limit 24 latched		Mask: 0080h	All
				15.23 Flexible limit 23 latched		Mask: 0040h	All
				15.22 Flexible limit 22 latched		Mask: 0020h	All
				15.21 Flexible limit 21 latched		Mask: 0010h	All
				15.20 Flexible limit 20 latched		Mask: 0008h	All
				15.19 Flexible limit 19 latched		Mask: 0004h	All
				15.18 Flexible limit 18 latched		Mask: 0002h	All
				15.17 Flexible limit 17 latched		Mask: 0001h	All
8	5-6	uint16		Internal			
9	1-2	uint16	4179	BITLIST Alarms Flexible thresholds 33-40 active			
				Internal		Mask: 8000h	All
				Internal		Mask: 4000h	All
				Internal		Mask: 2000h	All
				Internal		Mask: 1000h	All
				Internal		Mask: 0800h	All
				Internal		Mask: 0400h	All

9 Appendix

9.2.8 Protocol 5017 (Alarm Values Visualization)

CAN Mux	CAN Byte	Size	Index	Description	Unit	Scale	Model
				Internal		Mask: 0200h	All
				Internal		Mask: 0100h	All
				Alarm flexible limit 40		Mask: 0080h	All
				Alarm flexible limit 39		Mask: 0040h	All
				Alarm flexible limit 38		Mask: 0020h	All
				Alarm flexible limit 37		Mask: 0010h	All
				Alarm flexible limit 36		Mask: 0008h	All
				Alarm flexible limit 35		Mask: 0004h	All
				Alarm flexible limit 34		Mask: 0002h	All
				Alarm flexible limit 33		Mask: 0001h	All
9	3-4	uint16	10281	BITLIST Alarms Flexible thresholds 33-40 latched (unacknowledged)			
				Internal		Mask: 8000h	All
				Internal		Mask: 4000h	All
				Internal		Mask: 2000h	All
				Internal		Mask: 1000h	All
				Internal		Mask: 0800h	All
				Internal		Mask: 0400h	All
				Internal		Mask: 0200h	All
				Internal		Mask: 0100h	All
				15.40 Flexible limit 40 latched		Mask: 0080h	All
				15.39 Flexible limit 39 latched		Mask: 0040h	All
				15.38 Flexible limit 38 latched		Mask: 0020h	All
				15.37 Flexible limit 37 latched		Mask: 0010h	All
				15.36 Flexible limit 36 latched		Mask: 0008h	All
				15.35 Flexible limit 35 latched		Mask: 0004h	All
				15.34 Flexible limit 34 latched		Mask: 0002h	All
				15.33 Flexible limit 33 latched		Mask: 0001h	All
9	5-6	uint16		0 (reserve)			
10	1-2	uint16	4194	BITLIST Free Alarms 1-16 active			
				Free alarm 16		Mask: 8000h	All
				Free alarm 15		Mask: 4000h	All
				Free alarm 14		Mask: 2000h	All
				Free alarm 13		Mask: 1000h	All
				Free alarm 12		Mask: 0800h	All
				Free alarm 11		Mask: 0400h	All
				Free alarm 10		Mask: 0200h	All
				Free alarm 9		Mask: 0100h	All

CAN Mux	CAN Byte	Size	Index	Description	Unit	Scale	Model
				Free alarm 8		Mask: 0080h	All
				Free alarm 7		Mask: 0040h	All
				Free alarm 6		Mask: 0020h	All
				Free alarm 5		Mask: 0010h	All
				Free alarm 4 (same as Mux 6)		Mask: 0008h	All
				Free alarm 3 (same as Mux 6)		Mask: 0004h	All
				Free alarm 2 (same as Mux 6)		Mask: 0002h	All
				Free alarm 1 (same as Mux 6)		Mask: 0001h	All
10	3-4	uint16	10282	BITLIST Free Alarms 1-16 latched (unacknowledged)			
				16.16 Free alarm 16 latched		Mask: 8000h	All
				16.15 Free alarm 15 latched		Mask: 4000h	All
				16.14 Free alarm 14 latched		Mask: 2000h	All
				16.13 Free alarm 13 latched		Mask: 1000h	All
				16.12 Free alarm 12 latched		Mask: 0800h	All
				16.11 Free alarm 11 latched		Mask: 0400h	All
				16.10 Free alarm 10 latched		Mask: 0200h	All
				16.09 Free alarm 9 latched		Mask: 0100h	All
				16.08 Free alarm 8 latched		Mask: 0080h	All
				16.07 Free alarm 7 latched		Mask: 0040h	All
				16.06 Free alarm 6 latched		Mask: 0020h	All
				16.05 Free alarm 5 latched		Mask: 0010h	All
				16.04 Free alarm 4 latched (same as Mux 6)		Mask: 0008h	All
				16.03 Free alarm 3 latched (same as Mux 6)		Mask: 0004h	All
				16.02 Free alarm 2 latched (same as Mux 6)		Mask: 0002h	All
				16.01 Free alarm 1 latched (same as Mux 6)		Mask: 0001h	All
10	5-6	uint16		Internal			
Subtopic Internal DC Analogue Values Wirebreak							
11	1-2	uint16	4171	BITLIST Alarms Analog Inputs 1 active			
				Internal		Mask: 8000h	All
				Internal		Mask: 4000h	All
				Internal		Mask: 2000h	All
				Internal		Mask: 1000h	All
				Internal		Mask: 0800h	All
				Internal		Mask: 0400h	All
				Internal		Mask: 0200h	All
				Internal		Mask: 0100h	All
				Internal		Mask: 0080h	All

9 Appendix

9.2.8 Protocol 5017 (Alarm Values Visualization)

CAN Mux	CAN Byte	Size	Index	Description	Unit	Scale	Model
				Internal		Mask: 0040h	All
				Internal		Mask: 0020h	All
				Failure Charging Alternator (D+)		Mask: 0010h	All
				Battery over voltage 2		Mask: 0008h	All
				Battery under voltage 2		Mask: 0004h	All
				Battery over voltage 1		Mask: 0002h	All
				Battery under voltage 1		Mask: 0001h	All
11	3-4	uint16	10136	Alarms Analog Inputs 1 latched (unacknowledged)			
				Internal		Mask: 8000h	All
				Internal		Mask: 4000h	All
				Internal		Mask: 2000h	All
				Internal		Mask: 1000h	All
				Internal		Mask: 0800h	All
				Internal		Mask: 0400h	All
				Internal		Mask: 0200h	All
				Internal		Mask: 0100h	All
				Internal		Mask: 0080h	All
				Internal		Mask: 0040h	All
				Internal		Mask: 0020h	All
				05.11 Failure Charging Alternator (D+)		Mask: 0010h	All
				08.02 Battery over voltage 2 latched		Mask: 0008h	All
				08.04 Battery under voltage 2 latched		Mask: 0004h	All
				08.01 Battery over voltage 1 latched		Mask: 0002h	All
				08.03 Battery under voltage 1 latched		Mask: 0001h	All
11	5-6	uint16		Internal			
12	1-2	uint16	4173	Alarms Analog Inputs Wire Break active			
				Internal		Mask: 0001h	
				Analog inp. 1, wire break		Mask: 0002h	All
				Analog inp. 2, wire break		Mask: 0004h	All
				Analog inp. 3, wire break		Mask: 0008h	All
				Analog inp. 4, wire break or shortcut		Mask: 0010h	EG3500XT-P2
				Analog inp. 5, wire break or shortcut		Mask: 0020h	EG3500XT-P2
				Analog inp. 6, wire break or shortcut		Mask: 0040h	EG3500XT-P2
				Analog inp. 7, wire break or shortcut		Mask: 0080h	EG3500XT-P2
				Analog inp. 8, wire break or shortcut		Mask: 0100h	EG3500XT-P2
				Analog inp. 9, wire break or shortcut		Mask: 0200h	EG3500XT-P2
				Analog inp. 10, wire break or shortcut		Mask: 0400h	EG3500XT-P2

CAN Mux	CAN Byte	Size	Index	Description	Unit	Scale	Model
				Internal		Mask: 0800h	
				Internal		Mask: 1000h	
				Internal		Mask: 2000h	
				Internal		Mask: 4000h	
				Internal		Mask: 8000h	
12	3-4	uint16	10137	Alarms Analog Inputs Wire Break latched (unacknowledged)			
				Internal		Mask: 0001h	
				10.01 Analog input 1 wire break		Mask: 0002h	All
				10.02 Analog input 2 wire break		Mask: 0004h	All
				10.03 Analog input 3 wire break		Mask: 0008h	All
				10.04 Analog input 4 wire break		Mask: 0010h	EG3500XT-P2
				10.05 Analog input 5 wire break		Mask: 0020h	EG3500XT-P2
				10.06 Analog input 6 wire break		Mask: 0040h	EG3500XT-P2
				10.07 Analog input 7 wire break		Mask: 0080h	EG3500XT-P2
				10.08 Analog input 8 wire break		Mask: 0100h	EG3500XT-P2
				10.09 Analog input 9 wire break		Mask: 0200h	EG3500XT-P2
				10.10 Analog input 10 wire break		Mask: 0400h	EG3500XT-P2
				Internal		Mask: 0800h	
				Internal		Mask: 1000h	
				Internal		Mask: 2000h	
				Internal		Mask: 4000h	
				Internal		Mask: 8000h	
12	5-6	uint16		Internal			
Subtopic Internal Digital Inputs							
13	1-2	uint16	4181	Alarms Digital Inputs 1 active			
				Discrete input 1		Mask: 8000h	All
				Discrete input 2		Mask: 4000h	All
				Discrete input 3		Mask: 2000h	All
				Discrete input 4		Mask: 1000h	All
				Discrete input 5		Mask: 0800h	All
				Discrete input 6		Mask: 0400h	All
				Discrete input 7		Mask: 0200h	All
				Discrete input 8		Mask: 0100h	All
				Discrete input 9		Mask: 0080h	All
				Discrete input 10		Mask: 0040h	All
				Discrete input 11		Mask: 0020h	All
				Discrete input 12		Mask: 0010h	All

9 Appendix

9.2.8 Protocol 5017 (Alarm Values Visualization)

CAN Mux	CAN Byte	Size	Index	Description	Unit	Scale	Model
				Internal		Mask: 0008h	
				Internal		Mask: 0004h	
				Internal		Mask: 0002h	
				Internal		Mask: 0001h	
13	3-4	uint16	10132	Alarms Digital Inputs 1 latched (unacknowledged)			
				09.01 Discrete input 1 latched		Mask: 8000h	All
				09.02 Discrete input 2 latched		Mask: 4000h	All
				09.03 Discrete input 3 latched		Mask: 2000h	All
				09.04 Discrete input 4 latched		Mask: 1000h	All
				09.05 Discrete input 5 latched		Mask: 0800h	All
				09.06 Discrete input 6 latched		Mask: 0400h	All
				09.07 Discrete input 7 latched		Mask: 0200h	All
				09.08 Discrete input 8 latched		Mask: 0100h	All
				09.09 Discrete input 9 latched		Mask: 0080h	All
				09.10 Discrete input 10 latched		Mask: 0040h	All
				09.11 Discrete input 11 latched		Mask: 0020h	All
				09.12 Discrete input 12 latched		Mask: 0010h	All
				Internal		Mask: 0008h	
				Internal		Mask: 0004h	
				Internal		Mask: 0002h	
				Internal		Mask: 0001h	
13	5-6	uint16		Internal			
14	1-2	uint16	4183	AlarmsDigital Inputs 2 active			
				Digital Input 13		Mask: 8000h	EG3500XT-P2
				Digital Input 14		Mask: 4000h	EG3500XT-P2
				Digital Input 15		Mask: 2000h	EG3500XT-P2
				Digital Input 16		Mask: 1000h	EG3500XT-P2
				Digital Input 17		Mask: 0800h	EG3500XT-P2
				Digital Input 18		Mask: 0400h	EG3500XT-P2
				Digital Input 19		Mask: 0200h	EG3500XT-P2
				Digital Input 20		Mask: 0100h	EG3500XT-P2
				Digital Input 21		Mask: 0080h	EG3500XT-P2
				Digital Input 22		Mask: 0040h	EG3500XT-P2
				Digital Input 23		Mask: 0020h	EG3500XT-P2
				Internal		Mask: 0010h	
				Internal		Mask: 0008h	
				Internal		Mask: 0004h	

CAN Mux	CAN Byte	Size	Index	Description	Unit	Scale	Model
				Internal		Mask: 0002h	
				Internal		Mask: 0001h	
14	3-4	uint16	10283	Alarms Digital Inputs 2 latched (unacknowledged)			
				09.13 Discrete input 13 latched		Mask: 8000h	EG3500XT-P2
				09.14 Discrete input 14 latched		Mask: 4000h	EG3500XT-P2
				09.15 Discrete input 15 latched		Mask: 2000h	EG3500XT-P2
				09.16 Discrete input 16 latched		Mask: 1000h	EG3500XT-P2
				09.17 Discrete input 17 latched		Mask: 0800h	EG3500XT-P2
				09.18 Discrete input 18 latched		Mask: 0400h	EG3500XT-P2
				09.19 Discrete input 19 latched		Mask: 0200h	EG3500XT-P2
				09.20 Discrete input 20 latched		Mask: 0100h	EG3500XT-P2
				09.21 Discrete input 21 latched		Mask: 0080h	EG3500XT-P2
				09.22 Discrete input 22 latched		Mask: 0040h	EG3500XT-P2
				09.23 Discrete input 23 latched		Mask: 0020h	EG3500XT-P2
				Internal		Mask: 0010h	
				Internal		Mask: 0008h	
				Internal		Mask: 0004h	
				Internal		Mask: 0002h	
				Internal		Mask: 0001h	
14	5-6	uint16		Internal			
Subtopic External Digital Inputs							
15	1-2	uint16	4185	Alarms External Digital Inputs active			
				external Digital Input 16		Mask: 8000h	All
				external Digital Input 15		Mask: 4000h	All
				external Digital Input 14		Mask: 2000h	All
				external Digital Input 13		Mask: 1000h	All
				external Digital Input 12		Mask: 0800h	All
				external Digital Input 11		Mask: 0400h	All
				external Digital Input 10		Mask: 0200h	All
				external Digital Input 9		Mask: 0100h	All
				external Digital Input 8		Mask: 0080h	All
				external Digital Input 7		Mask: 0040h	All
				external Digital Input 6		Mask: 0020h	All
				external Digital Input 5		Mask: 0010h	All
				external Digital Input 4		Mask: 0008h	All
				external Digital Input 3		Mask: 0004h	All
				external Digital Input 2		Mask: 0002h	All

CAN Mux	CAN Byte	Size	Index	Description	Unit	Scale	Model
				external Digital Input 1		Mask: 0001h	All
15	3-4	uint16	16377	Alarms External Digital Inputs latched (unacknowledged)			
				12.16 External discrete input 16 latched		Mask: 8000h	All
				12.15 External discrete input 15 latched		Mask: 4000h	All
				12.14 External discrete input 14 latched		Mask: 2000h	All
				12.13 External discrete input 13 latched		Mask: 1000h	All
				12.12 External discrete input 12 latched		Mask: 0800h	All
				12.11 External discrete input 11 latched		Mask: 0400h	All
				12.10 External discrete input 10 latched		Mask: 0200h	All
				12.09 External discrete input 9 latched		Mask: 0100h	All
				12.08 External discrete input 8 latched		Mask: 0080h	All
				12.07 External discrete input 7 latched		Mask: 0040h	All
				12.06 External discrete input 6 latched		Mask: 0020h	All
				12.05 External discrete input 5 latched		Mask: 0010h	All
				12.04 External discrete input 4 latched		Mask: 0008h	All
				12.03 External discrete input 3 latched		Mask: 0004h	All
				12.02 External discrete input 2 latched		Mask: 0002h	All
				12.01 External discrete input 1 latched		Mask: 0001h	All
15	5-6	uint16		Internal			
16	1-2	uint16	4195	Alarm External Digital Inputs 1 active			
				external Digital Input 32		Mask: 8000h	All
				external Digital Input 31		Mask: 4000h	All
				external Digital Input 30		Mask: 2000h	All
				external Digital Input 29		Mask: 1000h	All
				external Digital Input 28		Mask: 0800h	All
				external Digital Input 27		Mask: 0400h	All
				external Digital Input 26		Mask: 0200h	All
				external Digital Input 25		Mask: 0100h	All
				external Digital Input 24		Mask: 0080h	All
				external Digital Input 23		Mask: 0040h	All
				external Digital Input 22		Mask: 0020h	All
				external Digital Input 21		Mask: 0010h	All
				external Digital Input 20		Mask: 0008h	All
				external Digital Input 19		Mask: 0004h	All
				external Digital Input 18		Mask: 0002h	All
				external Digital Input 17		Mask: 0001h	All

CAN Mux	CAN Byte	Size	Index	Description	Unit	Scale	Model
16	3-4	uint16	10284	Alarm External Digital Inputs 1 latched (unacknowledged)			
				12.32 External discrete input 32 latched		Mask: 8000h	All
				12.31 External discrete input 31 latched		Mask: 4000h	All
				12.30 External discrete input 30 latched		Mask: 2000h	All
				12.29 External discrete input 29 latched		Mask: 1000h	All
				12.28 External discrete input 28 latched		Mask: 0800h	All
				12.27 External discrete input 27 latched		Mask: 0400h	All
				12.26 External discrete input 26 latched		Mask: 0200h	All
				12.25 External discrete input 25 latched		Mask: 0100h	All
				12.24 External discrete input 24 latched		Mask: 0080h	All
				12.23 External discrete input 23 latched		Mask: 0040h	All
				12.22 External discrete input 22 latched		Mask: 0020h	All
				12.21 External discrete input 21 latched		Mask: 0010h	All
				12.20 External discrete input 20 latched		Mask: 0008h	All
				12.19 External discrete input 19 latched		Mask: 0004h	All
				12.18 External discrete input 18 latched		Mask: 0002h	All
				12.17 External discrete input 17 latched		Mask: 0001h	All
16	5-6	uint16		Internal			
Subtopic External DC Analogue Values Wirebreak							
17	1-2	uint16	4196	Alarms External Analog Inputs Wire Break active			
				Ext. analog inp. 1, wire break		Mask: 0001h	All
				Ext. analog inp. 2, wire break		Mask: 0002h	All
				Ext. analog inp. 3, wire break		Mask: 0004h	All
				Ext. analog inp. 4, wire break		Mask: 0008h	All
				Ext. analog inp. 5, wire break		Mask: 0010h	All
				Ext. analog inp. 6, wire break		Mask: 0020h	All
				Ext. analog inp. 7, wire break		Mask: 0040h	All
				Ext. analog inp. 8, wire break		Mask: 0080h	All
				Ext. analog inp. 9, wire break		Mask: 0100h	All
				Ext. analog inp. 10, wire break		Mask: 0200h	All
				Ext. analog inp. 11, wire break		Mask: 0400h	All
				Ext. analog inp. 12, wire break		Mask: 0800h	All
				Ext. analog inp. 13, wire break		Mask: 1000h	All
				Ext. analog inp. 14, wire break		Mask: 2000h	All
				Ext. analog inp. 15, wire break		Mask: 4000h	All
				Ext. analog inp. 16, wire break		Mask: 8000h	All

9 Appendix

9.2.8 Protocol 5017 (Alarm Values Visualization)

CAN Mux	CAN Byte	Size	Index	Description	Unit	Scale	Model
17	3-4	uint16	10285	Alarms External Analog Inputs Wire Break latched (unacknowledged)			
				25.01 Ext. analog input 1 wire break		Mask: 0001h	All
				25.02 Ext. analog input 2 wire break		Mask: 0002h	All
				25.03 Ext. analog input 3 wire break		Mask: 0004h	All
				25.04 Ext. analog input 4 wire break		Mask: 0008h	All
				25.05 Ext. analog input 5 wire break		Mask: 0010h	All
				25.06 Ext. analog input 6 wire break		Mask: 0020h	All
				25.07 Ext. analog input 7 wire break		Mask: 0040h	All
				25.08 Ext. analog input 8 wire break		Mask: 0080h	All
				25.09 Ext. analog input 9 wire break		Mask: 0100h	All
				25.10 Ext. analog input 10 wire break		Mask: 0200h	All
				25.11 Ext. analog input 11 wire break		Mask: 0400h	All
				25.12 Ext. analog input 12 wire break		Mask: 0800h	All
				25.13 Ext. analog input 13 wire break		Mask: 1000h	All
				25.14 Ext. analog input 14 wire break		Mask: 2000h	All
				25.15 Ext. analog input 15 wire break		Mask: 4000h	All
				25.16 Ext. analog input 16 wire break		Mask: 8000h	All
17	5	1 byte		Operating Range Monitoring Code Number			All
	6	1 byte		Internal			
18	1.2	uint16	10313	Alarms 4 latched (unacknowledged)			
				Internal	Bit	Mask: 8000h	
				Internal	Bit	Mask: 4000h	
				Internal	Bit	Mask: 2000h	
				06.36 Pole slip	Bit	Mask: 1000h	All
				07.33 FRT Time-dep. voltage 3	Bit	Mask: 0800h	All
				Internal	Bit	Mask: 0400h	
				Internal	Bit	Mask: 0200h	
				07.31 FRT Time-dep. voltage 2	Bit	Mask: 0100h	All
				Internal	Bit	Mask: 0080h	
				Internal	Bit	Mask: 0040h	
				Internal	Bit	Mask: 0020h	
				08.40 CAN J1939 device 3 timeout	Bit	Mask: 0010h	All
				08.39 CAN J1939 device 2 timeout	Bit	Mask: 0008h	All
				08.38 CAN J1939 device 1 timeout	Bit	Mask: 0004h	All
				08.37 CAN J1939 ECU timeout	Bit	Mask: 0002h	All
				08.29 CANopen error interface 3	Bit	Mask: 0001h	EG3500XT-P1

CAN Mux	CAN Byte	Size	Index	Description	Unit	Scale	Model
							EG3500XT-P2
18	3.4	uint16	10314	Alarms 4 active			
				Internal	Bit	Mask: 8000h	
				Internal	Bit	Mask: 4000h	
				Internal	Bit	Mask: 2000h	
				Pole slip	Bit	Mask: 1000h	All
				07.33 FRT Time-dep. voltage 3	Bit	Mask: 0800h	All
				Internal	Bit	Mask: 0400h	
				Internal	Bit	Mask: 0200h	
				FRT Time-dep. voltage 2	Bit	Mask: 0100h	All
				Internal	Bit	Mask: 0080h	
				Internal	Bit	Mask: 0040h	
				Internal	Bit	Mask: 0020h	
				CAN J1939 device 3 timeout	Bit	Mask: 0010h	All
				CAN J1939 device 2 timeout	Bit	Mask: 0008h	All
				CAN J1939 device 1 timeout	Bit	Mask: 0004h	All
				CAN J1939 ECU timeout	Bit	Mask: 0002h	All
				CANopen error interface 3	Bit	Mask: 0001h	EG3500XT-P1 EG3500XT-P2
18	5.6	uint16	4211	Bitlist Free alarms 17-32 actual			
				Free alarm 32		Mask: 8000h	All
				Free alarm 31		Mask: 4000h	All
				Free alarm 30		Mask: 2000h	All
				Free alarm 29		Mask: 1000h	All
				Free alarm 28		Mask: 0800h	All
				Free alarm 27		Mask: 0400h	All
				Free alarm 26		Mask: 0200h	All
				Free alarm 25		Mask: 0100h	All
				Free alarm 24		Mask: 0080h	All
				Free alarm 23		Mask: 0040h	All
				Free alarm 22		Mask: 0020h	All
				Free alarm 21		Mask: 0010h	All
				Free alarm 20		Mask: 0008h	All
				Free alarm 19		Mask: 0004h	All
				Free alarm 18		Mask: 0002h	All
				Free alarm 17		Mask: 0001h	All
19	1.2	uint16		Bitlist Free alarms 17-32 latched			

CAN Mux	CAN Byte	Size	Index	Description	Unit	Scale	Model
				Free alarm 32		Mask: 8000h	All
				Free alarm 31		Mask: 4000h	All
				Free alarm 30		Mask: 2000h	All
				Free alarm 29		Mask: 1000h	All
				Free alarm 28		Mask: 0800h	All
				Free alarm 27		Mask: 0400h	All
				Free alarm 26		Mask: 0200h	All
				Free alarm 25		Mask: 0100h	All
				Free alarm 24		Mask: 0080h	All
				Free alarm 23		Mask: 0040h	All
				Free alarm 22		Mask: 0020h	All
				Free alarm 21		Mask: 0010h	All
				Free alarm 20		Mask: 0008h	All
				Free alarm 19		Mask: 0004h	All
				Free alarm 18		Mask: 0002h	All
				Free alarm 17		Mask: 0001h	All
19	3.4	uint16		Internal			
19	5.6	uint16		Internal			
20	1.2	uint16		Internal			
20	3.4	uint16		Internal			
20	5.6	uint16		Internal			
21	5.6	uint16		Internal			
				21 Mux x 20ms = 0.42s refresh rate			

9.2.9 Additional Data Identifier

9.2.9.1 Receive Data (sent from remote control to the easYgen)

General notes

The device accepts receive data from outside. These data are usually remote control data, with which the genset control starts and stops the operation or runs different setpoints.

These data do not require a password level to be accepted. They are overtaken into a non-volatile memory and are lost, if the device is powered down.



Ensure Security!

Transmitting data from outside of the remote control needs secure (network) communication. Do not connect the easYgen with the internet as long the security aspects are not considered! Consider an IP responsible person to discuss proper security procedures like placing routers and fire walls.

Take care for sufficient protection of Ethernet communication.

Remote control word 1



Object 21F7h (Parameter 503)

This object is required for remote control. The data type is UNSIGNED16.

The internal parameter 503 of the easYgen must be set to react on the remote control instructions. This is performed by sending rising signals for the respective bits (refer to [Fig. 413](#) for the priority of start and stop signals).

Parameter no.	Object ID	Name	Unit	Data type	Note	
503	21F7h	Control word 1	Bit field	unsigned16		
		Bit 15	Not used			
		Bit 14	Not used			
		Bit 13	Not used			
		Bit 12	Not used			
		Bit 11	Not used			
		Bit 10	Not used			
		Bit 9	Shutdown command			To shut down, a "0" must be written and then a "1"
		Bit 8	Not used			
		Bit 7	Not used			
		Bit 6	Not used			
		Bit 5	Not used			
		Bit 4	Ext. Acknowledge (rising edge) Must be set twice to acknowledge			To acknowledge, a 0 must be written and then a 1
		Bit 3	Must always be set to 0			
		Bit 2	Must always be set to 0			
		Bit 1	Stop bit (rising edge)			To stop, a 0 must be written and then a 1
Bit 0	Start bit (rising edge)			To start, a 0 must be written and then a 1		

Table 157: Remote control telegram

Bit 0 Start bit	With the rising edge of the bit, the easYgen activates the remote request command (LogicsManager input command variable 04.13). The condition of the start command will be stored and may be used as command variable for the LogicsManager.
Bit 1 Stop bit	With the rising edge of the bit, the easYgen deactivates the remote request command (LogicsManager input command variable 04.13). The condition of the start command will be stored and may be used as command variable for the LogicsManager.
Bit 4 "Reset alarms"	This bit controls the LogicsManager input command variable 04.14. The remote acknowledge bit must be set and reset twice to acknowledge an alarm completely. The first rising edge disables the horn and the second rising edge resets the alarm.
Bit 9 "Shutdown command"	This bit is directly influencing the LogicsManager command variable: "03.40 Remote Shutdown" and can be taken to create an engine shut down and/or an alarm over an internal flag.
Remote start /stop	The command variable "04.13 Remote request" changes to "1" (high) if the start bit is enabled and changes back to "0" (low) if the stop bit is enabled.
Ext. acknowledge	The command variable "04.14 Remote acknowledge" is the reflection of the control bit. The easYgen deactivates the horn with the first change from "0" to "1" of the logical output "External acknowledge", and acknowledges all alarm messages, which have occurred and are no longer active, with the second change from "0" to "1".

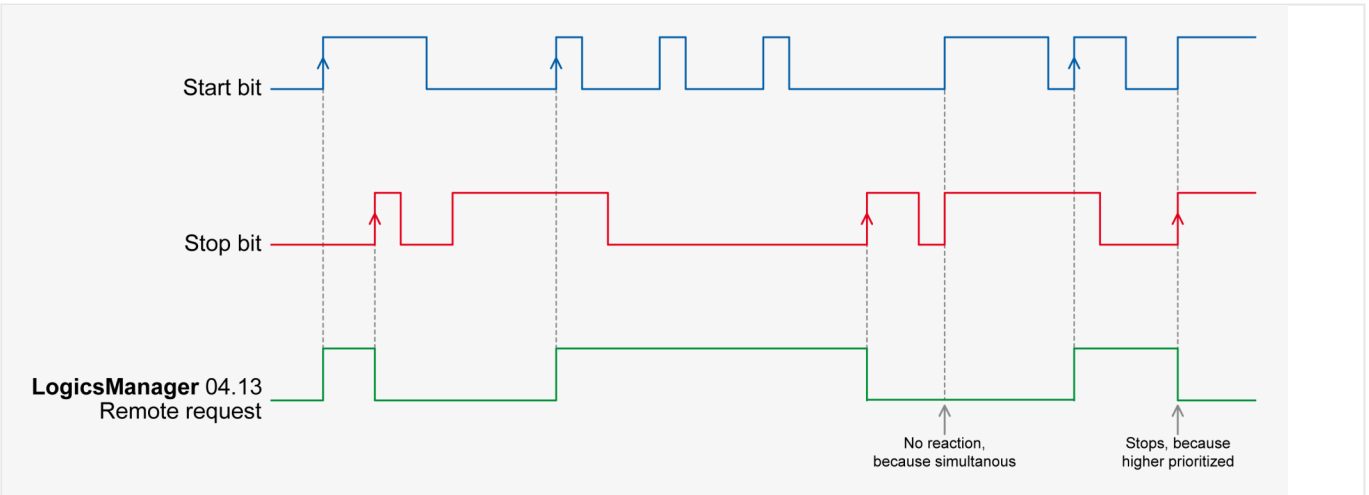

Fig. 413: Remote control - start/stop priority

Fig. 413 shows the reaction of the command variable on the various status changes of the bits.

i The easYgen does **not** react on the disabling of the start bit, but only on the enabling of the stop bit. This has the advantage that it is not required to maintain the connection established for the whole time in case of a remote start via a modem.

Remote control word 2

i **Object 21F8h (Parameter 504)**
This object is required for remote control. The data type is UNSIGNED16.

Bit 15 = 1	
Bit 14 = 1	
Bit 13 = 1	
Bit 12 = 1	
Bit 11 = 1	
Bit 10 = 1	
Bit 9 = 1	
Bit 8 = 1	
Bit 7 = 1	Request active power setpoint 2 - this bit activates the LogicsManager command variable [04.40] "Remote power setpoint 2" and is dedicated for switching from active power setpoint 1 to active power setpoint 2
Bit 6 = 1	Request power factor setpoint 2 - this bit activates the LogicsManager command variable [04.39] "Remote PF setpoint 2" and is dedicated for switching from power factor setpoint 1 to power factor setpoint 2
Bit 5 = 1	Request frequency setpoint 2 - this bit activates the LogicsManager command variable [04.38] "Remote frequency setpoint 2" and is dedicated for switching from frequency setpoint 1 to frequency setpoint 2
Bit 4 = 1	Request voltage setpoint 2 - this bit activates the LogicsManager command variable [04.37] "Remote voltage setpoint 2" and is dedicated for switching from voltage setpoint 1 to voltage setpoint 2
Bit 3 = 1	
Bit 2 = 1	
Bit 1 = 1	
Bit 0 = 1	

Remote control word 3



Object 21F9h (Parameter 505)

This object is required for remote control. These remote control bits can be used by a PLC to send control signals via SDO or PDO, which can then be used as command variables in the LogicsManager to control the easYgen. The data type is UNSIGNED16.

Bit 15 = 1 (ID 541)	Remote control bit 16 (command variable 04.59)
Bit 14 = 1 (ID 542)	Remote control bit 15 (command variable 04.58)
Bit 13 = 1 (ID 543)	Remote control bit 14 (command variable 04.57)
Bit 12 = 1 (ID 544)	Remote control bit 13 (command variable 04.56)
Bit 11 = 1 (ID 545)	Remote control bit 12 (command variable 04.55)
Bit 10 = 1 (ID 546)	Remote control bit 11 (command variable 04.54)
Bit 9 = 1 (ID 547)	Remote control bit 10 (command variable 04.53)
Bit 8 = 1 (ID 548)	Remote control bit 9 (command variable 04.52)
Bit 7 = 1 (ID 549)	Remote control bit 8 (command variable 04.51)
Bit 6 = 1 (ID 550)	Remote control bit 7 (command variable 04.50)
Bit 5 = 1 (ID 551)	Remote control bit 6 (command variable 04.49)

Bit 4 = 1 (ID 552)	Remote control bit 5 (command variable 04.48)
Bit 3 = 1 (ID 553)	Remote control bit 4 (command variable 04.47)
Bit 2 = 1 (ID 554)	Remote control bit 3 (command variable 04.46)
Bit 1 = 1 (ID 555)	Remote control bit 2 (command variable 04.45)
Bit 0 = 1 (ID 556)	Remote control bit 1 (command variable 04.44)

Remote active power setpoint



Object 21FBh (Parameter 507)

This value may be used as data source "[05.56] Interface P setp [kW]" via the AnalogManager. No password is required to write this value.

This object is required to transmit the active power setpoint for active power control.

The data type is INTEGER32.

The value is scaled in [kW * 10].

Example

- 100 kW = 1000 = 03E8h

Remote power factor setpoint



Object 21FCh (Parameter 508)

This value may be used as data source "[05.12] Interface PF sp [%]" via the AnalogManager. No password is required to write this value.

This object is required to transmit the power factor setpoint for power factor control.

The data type is INTEGER16.

The valid range for this value is [-710 to 1000 to 710].

Example

- PF (cosphi) = c0.71 (capacitive) = -710 = FD3Ah
- PF (cosphi) = 1.00 = 1000 = 03E8h
- PF (cosphi) = i0.71 (inductive) = 710 = 02C6h

Remote Frequency Setpoint - Object 21FDh

Remote frequency setpoint**Object 21FDh (Parameter 509)**

This value may be used as data source "[05.53] Interface f setp [Hz]" via the AnalogManager. No password is required to write this value.

This object is required to transmit the frequency setpoint for frequency control.

The data type is INTEGER16.

The valid range for this value is [Hz * 100].

Example

- 50.00 Hz = 5000 = 1388h

Remote voltage setpoint**Object 21FEh (Parameter 510)**

This value may be used as data source "[05.59] Interface V setp [V]" via the AnalogManager. No password is required to write this value.

This object is required to transmit the voltage setpoint for voltage control.

The data type is UNSIGNED32.

The value is scaled in [V].

Example

- 400 V » 400 = 190h
- 10000 V » 10000 = 2710h

Remote reactive power setpoint**Object 21FFh (Parameter 511)**

This value may be used as data source "[05.83] Interf.kvar sp [kvar]" via the AnalogManager. No password is required to write this value. This object is required to transmit the reactive power setpoint for the kvar control.

The data type is signed INTEGER32.

The value is scaled in [kvar*10].

Examples:

- 100.0 kvar » 1000 = 3E8h
- 100.2 kvar » 1002 = 3EAh

Q(V) voltage shift VQ0



Object 2200h (Parameter 512)

This is the Setpoint for the reactive power - voltage function Q(V). [VDE-AR-N 4110]

Interface reference value VQ0 has the resolution of (1/100) steps. The “starting” value is 1.00. A value limitation is included.

Remote LDSS IOP reserve power



Object 2232h (Parameter 562)

This value may be used to modify LDSS reserve power value [kW] for island operation via interface.

Notes:

- Parameters “5760 IOP Reserve power”, “5648 IOP Reserve power 2” and LM “120604 IOP Reserve power 2” are not overwritten by this write command.
- The last change either via interface or via the parameter selected with the LM is effective.
- If there is no change anymore, the last change will be kept until power cycling the device.
- After power cycling, the parameter value is used until the easYgen receives a different value via interface.
- The parameter alignment is still done with the active parameter value.

Remote LDSS MOP reserve power



Object 2233h (Parameter 563)

This value may be used to modify LDSS reserve power value [kW] for parallel to mains operation via interface.

Notes:

- Parameter “5768 MOP Reserve power”, “5649 MOP Reserve power 2” and LM “120605 MOP Reserve power 2” are not overwritten by this write command.
- The last change either via interface or via the parameter selected with the LM is effective.
- If there is no change anymore, the last change will be kept until power cycling the device.
- After power cycling, the parameter value is used until the easYgen receives a different value via interface.
- The parameter alignment is still done with the active parameter value.

Free analog values

The device provides identifier “Free analog values” for receiving 16 bit signed integers for free purposes. The values are available in the AnalogManager group 24. Refer to [↩️ “9.2.9.3.4 Free Analog Values”](#)

External DI request (1 to 16)**Object 3F4Eh (Parameter 8014)**

This object is required to receive the state of the external discrete inputs 1 to 16 (e.g. of a Phoenix expansion card). The data type is UNSIGNED16.

Bit 15	External discrete input 16 [Dlex16]
Bit 14	External discrete input 15 [Dlex15]
Bit 13	External discrete input 14 [Dlex14]
Bit 12	External discrete input 13 [Dlex13]
Bit 11	External discrete input 12 [Dlex12]
Bit 10	External discrete input 11 [Dlex11]
Bit 9	External discrete input 10 [Dlex10]
Bit 8	External discrete input 9 [Dlex09]
Bit 7	External discrete input 8 [Dlex08]
Bit 6	External discrete input 7 [Dlex07]
Bit 5	External discrete input 6 [Dlex06]
Bit 4	External discrete input 5 [Dlex05]
Bit 3	External discrete input 4 [Dlex04]
Bit 2	External discrete input 3 [Dlex03]
Bit 1	External discrete input 2 [Dlex02]
Bit 0	External discrete input 1 [Dlex01]

External DI request (17 to 32)**Object 3F4Fh (Parameter 8015)**

This object is required to receive the state of the external discrete inputs 17 to 32 (e.g. of a Phoenix expansion card). The data type is UNSIGNED16.

Bit 15	External discrete input 32 [Dlex32]
Bit 14	External discrete input 31 [Dlex31]
Bit 13	External discrete input 30 [Dlex30]
Bit 12	External discrete input 29 [Dlex29]
Bit 11	External discrete input 28 [Dlex28]
Bit 10	External discrete input 27 [Dlex27]
Bit 9	External discrete input 26 [Dlex26]
Bit 8	External discrete input 25 [Dlex25]
Bit 7	External discrete input 24 [Dlex24]
Bit 6	External discrete input 23 [Dlex23]
Bit 5	External discrete input 22 [Dlex22]

Bit 4	External discrete input 21 [Dlex21]
Bit 3	External discrete input 20 [Dlex20]
Bit 2	External discrete input 19 [Dlex19]
Bit 1	External discrete input 18 [Dlex18]
Bit 0	External discrete input 17 [Dlex17]

External Analog Inputs



Object 4008h ff, Subindex 1 (Parameter 8200 ff)

This unscaled value is transmitted by the external expansion board. The easYgen must be configured to format this value accordingly. The data type is UNSIGNED16.

The external analog inputs 1 to 16 have the following parameter IDs:

AI #	1	2	3	4	5	6	7	8
Object	4008	4009	400A	400B	400C	400D	400E	400F
ID	8200	8201	8202	8203	8204	8205	8206	8207

AI #	9	10	11	12	13	14	15	16
Object	4010	4011	4012	4013	4014	4015	4016	4017
ID	8208	8209	8210	8211	8212	8213	8214	8215

9.2.9.2 Transmit Data (sent from easYgen to control external devices)

The device sends data out which are receipt by external devices. These data usually are commands to control expansion boards or annunciators running CANopen.

External DO control (1 to 16)



Object 3F45h (Parameter 8005)

This object is required to control the external outputs (relays) 1 to 16 (e.g. of a Phoenix expansion card). The data type is UNSIGNED16.

Bit 15	External discrete output 16 [Rex16]
Bit 14	External discrete output 15 [Rex15]
Bit 13	External discrete output 14 [Rex14]
Bit 12	External discrete output 13 [Rex13]
Bit 11	External discrete output 12 [Rex12]
Bit 10	External discrete output 11 [Rex11]
Bit 9	External discrete output 10 [Rex10]
Bit 8	External discrete output 9 [Rex09]
Bit 7	External discrete output 8 [Rex08]

Bit 6	External discrete output 7 [Rex07]
Bit 5	External discrete output 6 [Rex06]
Bit 4	External discrete output 5 [Rex05]
Bit 3	External discrete output 4 [Rex04]
Bit 2	External discrete output 3 [Rex03]
Bit 1	External discrete output 2 [Rex02]
Bit 0	External discrete output 1 [Rex01]

External DO control (17 to 32)



Object 3F49h (Parameter 8009)

This object is required to control the external outputs (relays) 17 to 32 (e.g. of a Phoenix expansion card). The data type is UNSIGNED16.

Bit 15	External discrete output 32 [Rex32]
Bit 14	External discrete output 31 [Rex31]
Bit 13	External discrete output 30 [Rex30]
Bit 12	External discrete output 29 [Rex29]
Bit 11	External discrete output 28 [Rex28]
Bit 10	External discrete output 27 [Rex27]
Bit 9	External discrete output 26 [Rex26]
Bit 8	External discrete output 25 [Rex25]
Bit 7	External discrete output 24 [Rex24]
Bit 6	External discrete output 23 [Rex23]
Bit 5	External discrete output 22 [Rex22]
Bit 4	External discrete output 21 [Rex21]
Bit 3	External discrete output 20 [Rex20]
Bit 2	External discrete output 19 [Rex19]
Bit 1	External discrete output 18 [Rex18]
Bit 0	External discrete output 17 [Rex17]

External Analog Outputs



Object 4806h ff, Subindex 1 (Parameter ID 10246 ff)

This unscaled value is transmitted by the external expansion board. The easYgen must be configured to format this value accordingly. The data type is UNSIGNED16.

The external analog outputs 1 to 4 have the following parameter IDs:

AI #	1	2	3	4
Object	4806hex	4810hex	481Ahex	4824hex

AI #	1	2	3	4
ID	10245	10255	10265	10275

9.2.9.3 Data Receive (interconnectivity)

9.2.9.3.1 Introduction

The easYgen provides different possibilities to receive data from other CAN or Modbus devices. The received data are available in the AnalogManager or LogicsManager system.

There are:

- Analog variables called CAN1 RPDO...
- Command variables (single bits of some Analog variables)
- Free analog values

9.2.9.3.2 Analog variables CAN1 RPDO

The table below shows data which can be received via **CAN RPDO** or **Modbus** from any other devices. These data are available as analog variables (of group 21) and can be assigned to analog manager equations e.g. for free alarms or setpoints. For usage with CAN the corresponding indices must be mapped to the RPDOs. It is also possible to write via Modbus to these indices.



If “LDSS with predicted load” is used in “External” mode, RPDOx Word1 and RPDOx Word2 are used for LDSS and are not available for other functions. (Refer to [↪ “6.3.17 LDSS with predicted load”](#)).

Analog variable	Receive PDO	Index
21.01 CAN1 RPDO1.1	RPDO1 Word1 (signed short)	3371
21.02 CAN1 RPDO1.2	RPDO1 Word2 (signed short)	3372
21.03 CAN1 RPDO1.3	RPDO1 Word3 (signed short)	3373
21.04 CAN1 RPDO1.4	RPDO1 Word4 (signed short)	3374
21.05 CAN1 RPDO2.1	RPDO2 Word1 (signed short)	3375
21.06 CAN1 RPDO2.2	RPDO2 Word2 (signed short)	3376
21.07 CAN1 RPDO2.3	RPDO2 Word3 (signed short)	3377
21.08 CAN1 RPDO2.4	RPDO2 Word4 (signed short)	3378
21.09 CAN1 RPDO3.1	RPDO3 Word1 (signed short)	3379
21.10 CAN1 RPDO3.2	RPDO3 Word2 (signed short)	3380
21.11 CAN1 RPDO3.3	RPDO3 Word3 (signed short)	3381
21.12 CAN1 RPDO3.4	RPDO3 Word4 (signed short)	3382
21.13 CAN1 RPDO4.1	RPDO4 Word1 (signed short)	3383
21.14 CAN1 RPDO4.2	RPDO4 Word2 (signed short)	3384
21.15 CAN1 RPDO4.3	RPDO4 Word3 (signed short)	3385

Analog variable	Receive PDO	Index
21.16 CAN1 RPDO4.4	RPDO4 Word4 (signed short)	3386
21.17 CAN1 RPDO5.1	RPDO5 Word1 (signed short)	3387
21.18 CAN1 RPDO5.2	RPDO5 Word2 (signed short)	3388
21.19 CAN1 RPDO5.3	RPDO5 Word3 (signed short)	3389
21.20 CAN1 RPDO5.4	RPDO5 Word4 (signed short)	3390

9.2.9.3.3 Command variables CAN 1 RPDO

The single bits 1-16 of RPDO1 Word1 (3371), RPDO2 Word1 (3375), RPDO3 Word1 (3379), RPDO4 Word1 (3383) and RPDO5 Word1 (3387) are available as command variables of groups 32 to 36 which can be assigned to LogicsManagers.

LogicsManager variable	Index
32.01 CAN1 RPDO1.1.1	3371
32.02 CAN1 RPDO1.1.2	
32.03 CAN1 RPDO1.1.3	
32.04 CAN1 RPDO1.1.4	
32.05 CAN1 RPDO1.1.5	
32.06 CAN1 RPDO1.1.6	
32.07 CAN1 RPDO1.1.7	
32.08 CAN1 RPDO1.1.8	
32.09 CAN1 RPDO1.1.9	
32.10 CAN1 RPDO1.1.10	
32.11 CAN1 RPDO1.1.11	
32.12 CAN1 RPDO1.1.12	
32.13 CAN1 RPDO1.1.13	
32.14 CAN1 RPDO1.1.14	
32.15 CAN1 RPDO1.1.15	
32.16 CAN1 RPDO1.1.16	
33.01 CAN1 RPDO2.1.01	3375
33.02 CAN1 RPDO2.1.2	
33.03 CAN1 RPDO2.1.3	
33.04 CAN1 RPDO2.1.4	
33.05 CAN1 RPDO2.1.5	
33.06 CAN1 RPDO2.1.6	
33.07 CAN1 RPDO2.1.7	
33.08 CAN1 RPDO2.1.8	
33.09 CAN1 RPDO2.1.9	
33.10 CAN1 RPDO2.1.10	
33.11 CAN1 RPDO2.1.11	

9 Appendix

9.2.9.3.3 Command variables CAN 1 RPDO

LogicsManager variable	Index
33.12 CAN1 RPDO2.1.12	
33.13 CAN1 RPDO2.1.13	
33.14 CAN1 RPDO2.1.14	
33.15 CAN1 RPDO2.1.15	
33.16 CAN1 RPDO2.1.16	
34.01 CAN1 RPDO3.1.1	
34.02 CAN1 RPDO3.1.2	
34.03 CAN1 RPDO3.1.3	
34.04 CAN1 RPDO3.1.4	
34.05 CAN1 RPDO3.1.5	
34.06 CAN1 RPDO3.1.6	
34.07 CAN1 RPDO3.1.7	
34.08 CAN1 RPDO3.1.8	
34.09 CAN1 RPDO3.1.9	
34.10 CAN1 RPDO3.1.10	
34.11 CAN1 RPDO3.1.11	
34.12 CAN1 RPDO3.1.12	
34.13 CAN1 RPDO3.1.13	
34.14 CAN1 RPDO3.1.14	
34.15 CAN1 RPDO3.1.15	
34.16 CAN1 RPDO3.1.16	
35.01 CAN1 RPDO4.1.1	3383
35.02 CAN1 RPDO4.1.2	
35.03 CAN1 RPDO4.1.3	
35.04 CAN1 RPDO4.1.4	
35.05 CAN1 RPDO4.1.5	
35.06 CAN1 RPDO4.1.6	
35.07 CAN1 RPDO4.1.7	
35.08 CAN1 RPDO4.1.8	
35.09 CAN1 RPDO4.1.9	
35.10 CAN1 RPDO4.1.10	
35.11 CAN1 RPDO4.1.11	
35.12 CAN1 RPDO4.1.12	
35.13 CAN1 RPDO4.1.13	
35.14 CAN1 RPDO4.1.14	
35.15 CAN1 RPDO4.1.15	
35.16 CAN1 RPDO4.1.16	
36.01 CAN1 RPDO5.1.1	3387

LogicsManager variable	Index
36.02 CAN1 RPDO5.1.2	
36.03 CAN1 RPDO5.1.3	
36.04 CAN1 RPDO5.1.4	
36.05 CAN1 RPDO5.1.5	
36.06 CAN1 RPDO5.1.6	
36.07 CAN1 RPDO5.1.7	
36.08 CAN1 RPDO5.1.8	
36.09 CAN1 RPDO5.1.9	
36.10 CAN1 RPDO5.1.10	
36.11 CAN1 RPDO5.1.11	
36.12 CAN1 RPDO5.1.12	
36.13 CAN1 RPDO5.1.13	
36.14 CAN1 RPDO5.1.14	
36.15 CAN1 RPDO5.1.15	
36.16 CAN1 RPDO5.1.16	

The figure below shows how the name of these Command Variables are composed. (The naming of the variables was chosen with regard to their usage as CAN1 RPDOs.)

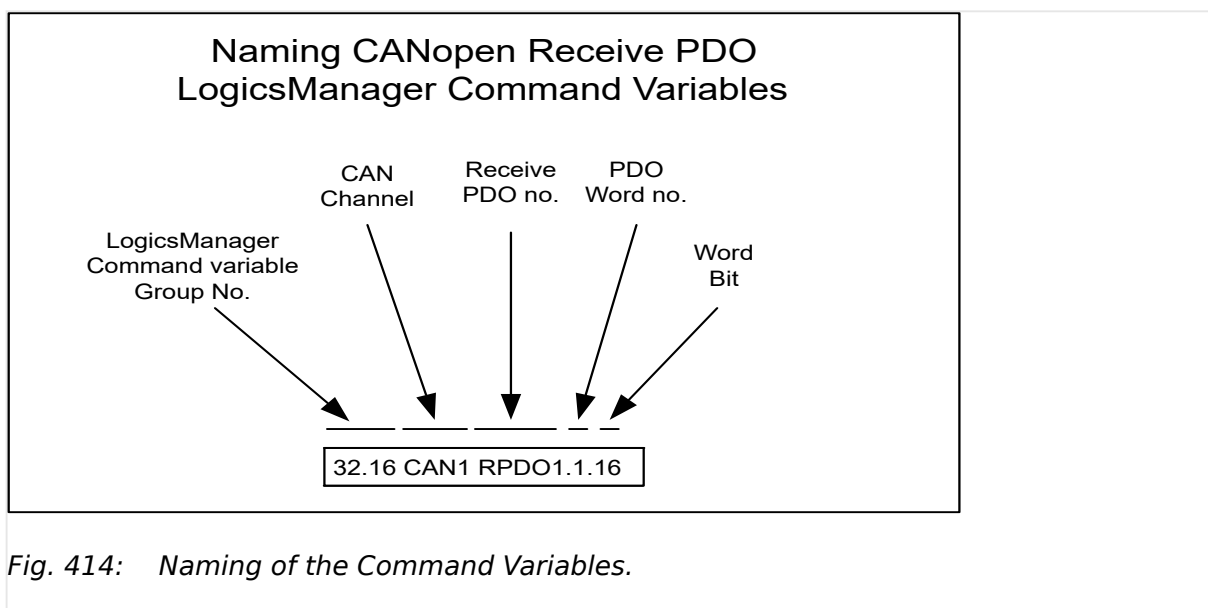

The figure below shows an example of how CAN 1 RPDOs can be configured for interconnectivity. The 4 data words received at

- COB-ID 1026 (dec) are assigned to the Analog Variables 21.01, 21.02, 21.03 and 21.04 via configuration. The bits of 21.01 are assigned internally to the Command Variables 32.01 - 32.16.
- COB-ID 1030 (dec) are assigned to the Analog Variables 21.17, 21.18, 21.19 and 21.20 via configuration. The bits of 21.17 are assigned internally to the Command Variables 36.01 - 36.16.

These Analog Variables and Command Variables can be used in AnalogManagers and LogicsManagers equations to control different functions.

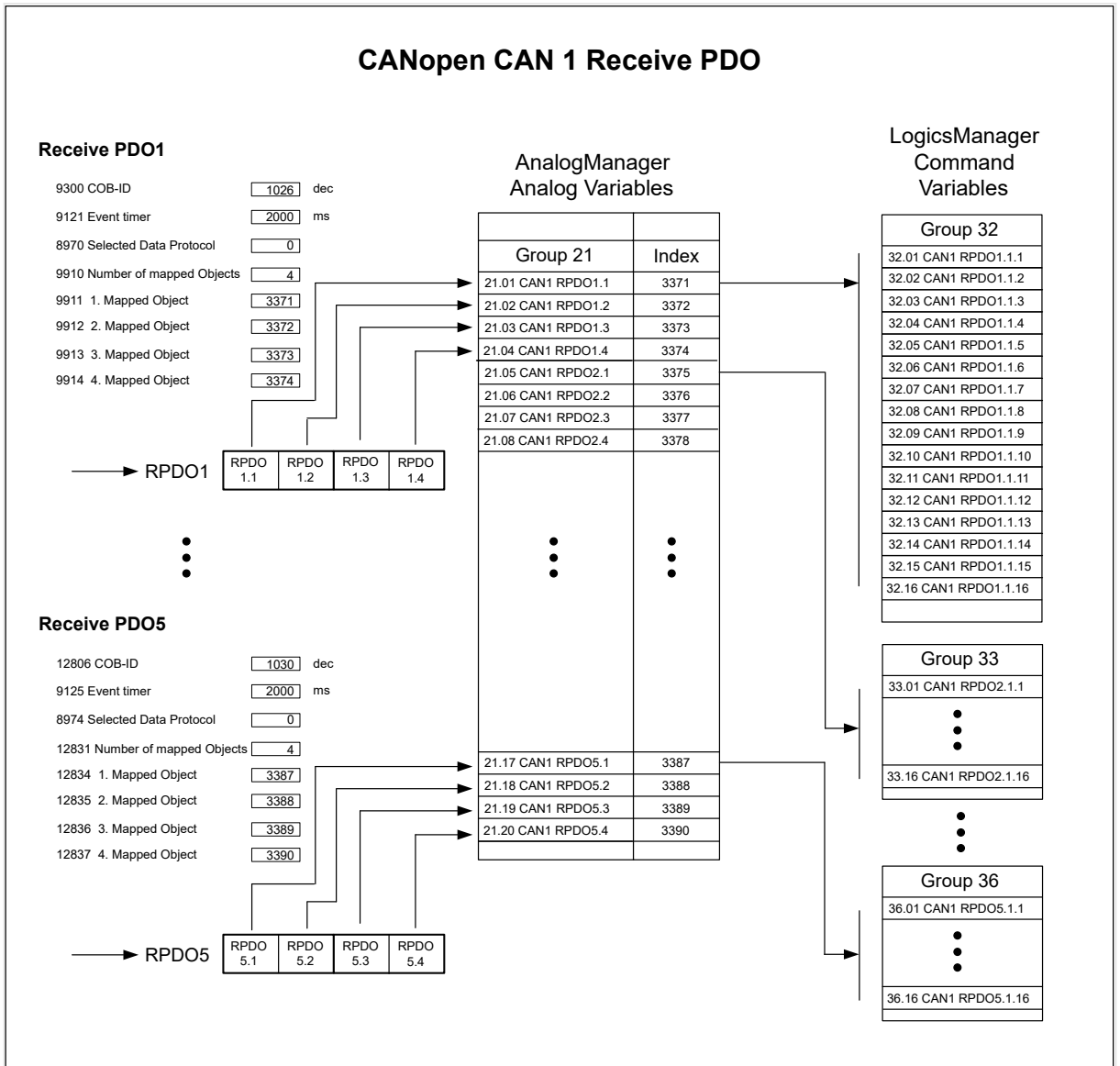

Fig. 415: Example of a CAN 1 RPDO configuration for interconnectivity.

9.2.9.3.4 Free Analog Values

Additionally the device provides “Free analog values” for receiving data for free purposes. These indices can be mapped to RPDOs or can be written via Modbus. The values are available in the AnalogManager group 24.

In future releases (higher than 2.10-0) the variables 24.05-24.08 will be write-protected with code level CL1.

Index	Name	Format	Usable as
587	Free analog value 1	INT16 signed	AnalogManager 24.01

Index	Name	Format	Usable as
588	Free analog value 2	INT16 signed	AnalogManager 24.02
589	Free analog value 3	INT16 signed	AnalogManager 24.03
590	Free analog value 4	INT16 signed	AnalogManager 24.04
591	Free analog value 5	INT16 signed	AnalogManager 24.05
592	Free analog value 6	INT16 signed	AnalogManager 24.06
593	Free analog value 7	INT16 signed	AnalogManager 24.07
594	Free analog value 8	INT16 signed	AnalogManager 24.08

9.2.9.4 Data Identifiers in General

The communication interface programmer needs often for single data transfer the identifier of the easYgen variable. To figure that out he has here some tips.

Data Protocol Document: Identifier Information in Column "Parameter ID"

The data protocol document shows usually in the column "Parameter ID" the identifier for a single use. Please check the type. Usually it is a signed INT16 (Short) variable but depending on the function it can also be a signed INT32 (Long). Typical values for long are voltages, currents and power measurement values.

			Gen. Overload IOP 2	Mask: 0002h	Bit
			internal	Mask: 0001h	Bit
1	1,2	4163	Alarms Generator 1 active		
			Unbal. load 1	Mask: 8000h	Bit
			Unbal. load 2	Mask: 4000h	Bit
			Gen. Asymmetry	Mask: 2000h	Bit
			Ground fault 1	Mask: 1000h	Bit
			Ground fault 2	Mask: 0800h	Bit
			Gen. phase rot. misw.	Mask: 0400h	Bit
			Gen act.pwr mismatch	Mask: 0200h	Bit



Fig. 416: Data Protocol Document in Columns "Parameter ID"

ToolKit: Identifier in front of the parameter or visualization

Nearly each parameter in ToolKit shows the according identifier in front of the data. The data type is to check. Usually it is a signed INT16 (Short) variable but depending on the function it can also be a signed INT32 (Long). Typical values for long are voltages, currents and power measurement values.

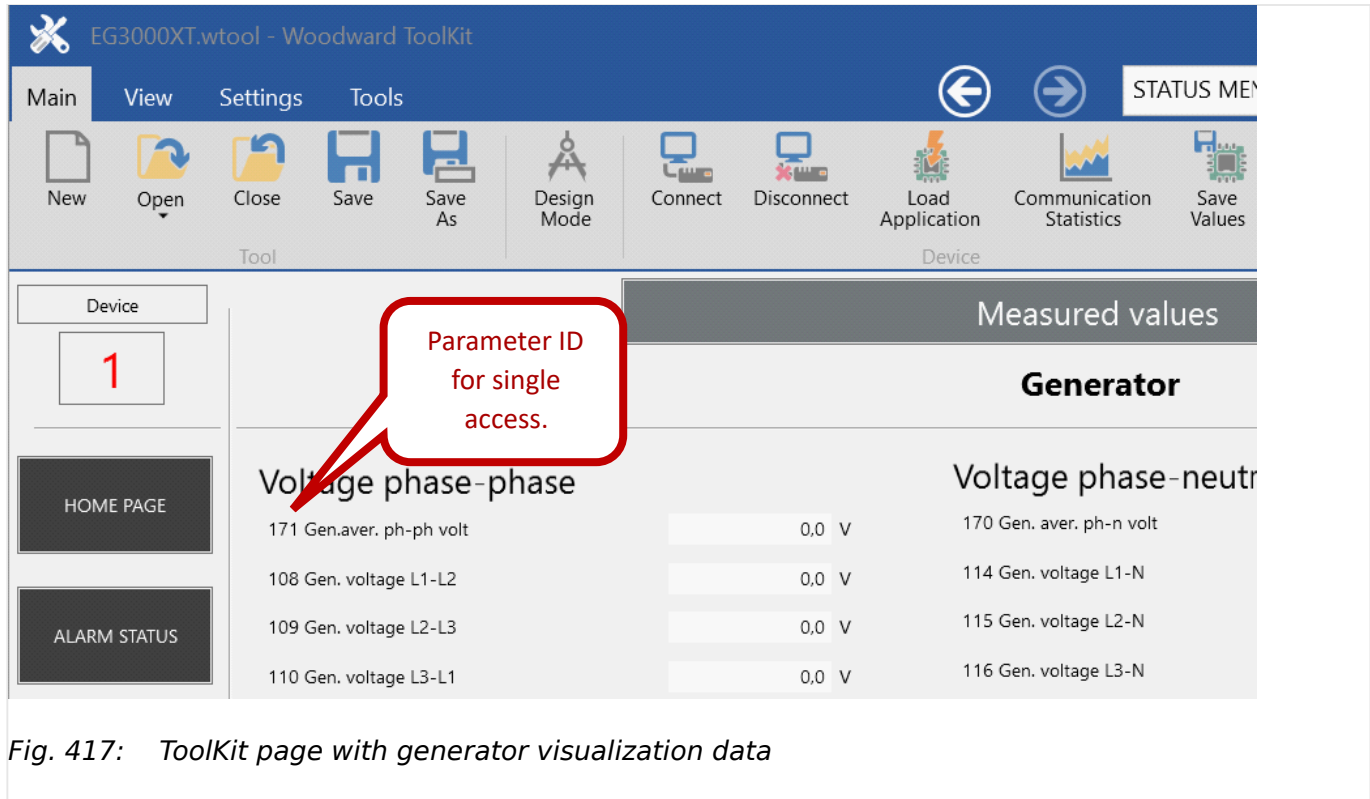

Fig. 417: ToolKit page with generator visualization data

With a few minor exceptions the reading of parameter are always possible. Writing of parameter is only accepted if the correct code level was passed for the according interface channel.

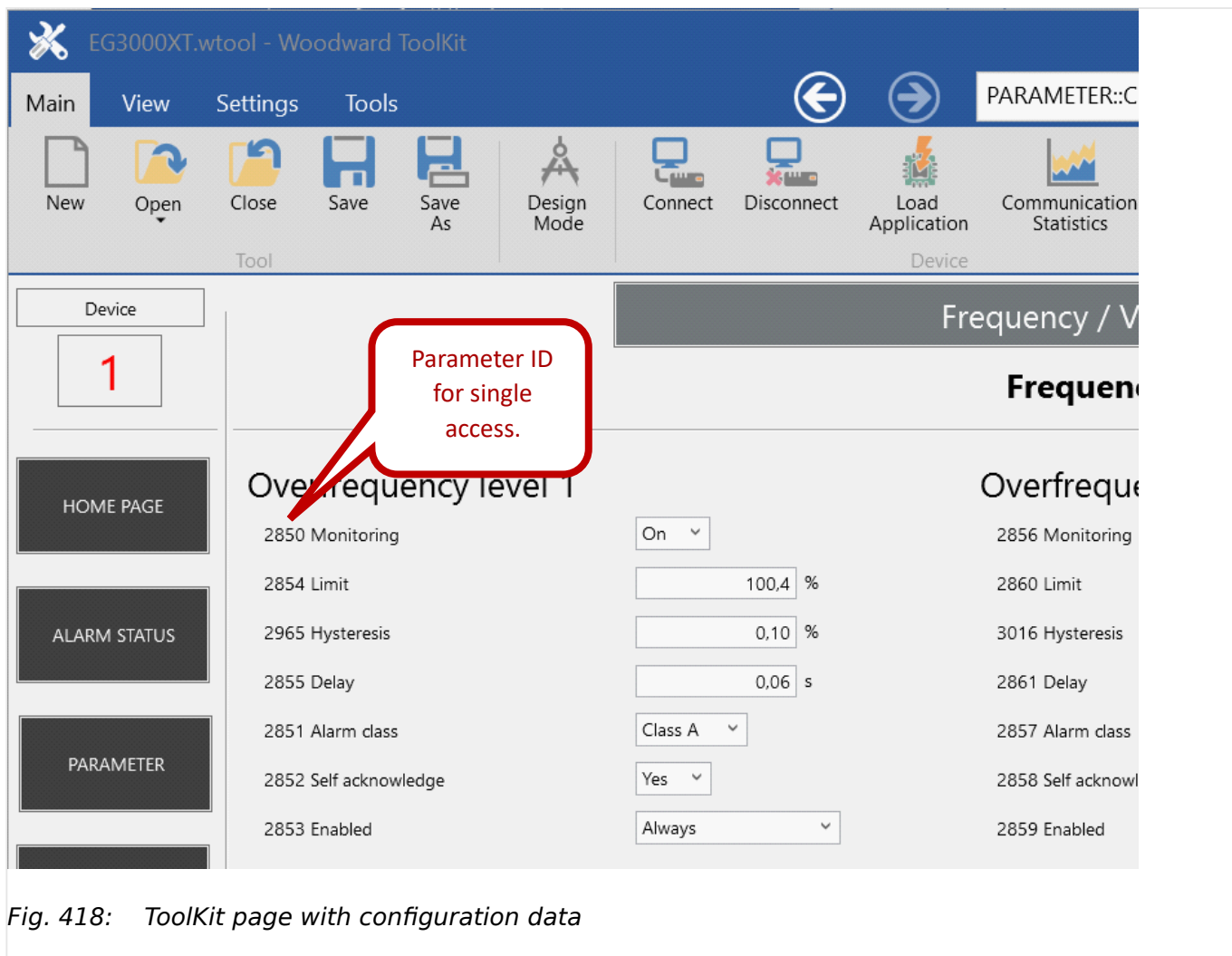

Fig. 418: ToolKit page with configuration data

The access on AnalogManager variables is provided as a signed 4 byte float value without decimals.

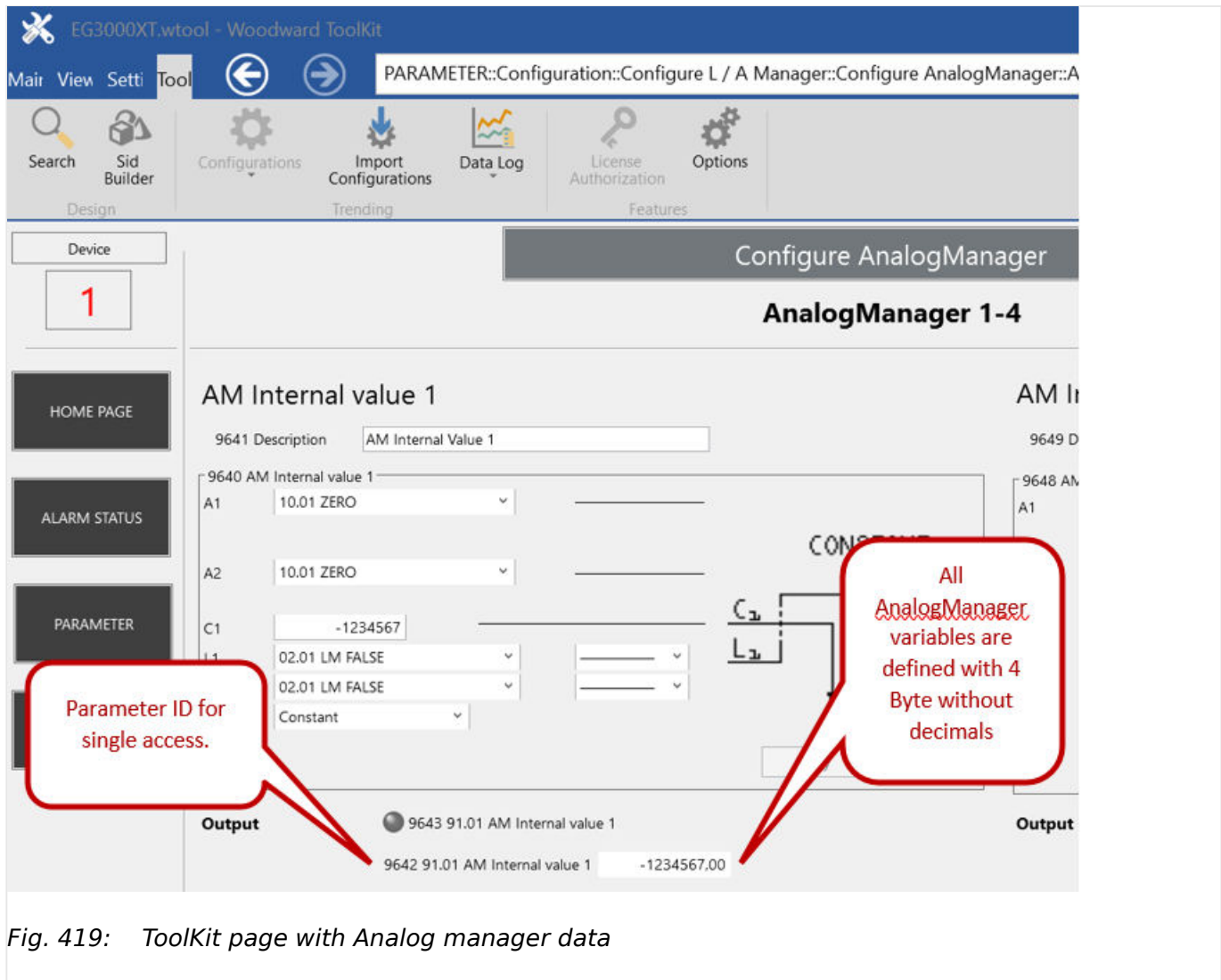

Fig. 419: ToolKit page with Analog manager data

9.3 LogicsManager Reference

9.3.1 LogicsManager Overview

The LogicsManager is used to customize the sequence of events in the control unit such as the start command of the engine or the operation of control unit relay outputs. For example, the start routine may be programmed so that it requires the closing of a discrete input or a preset time of day.

Depending on the application mode of the unit, the number of available relays that may be programmed with the LogicsManager will vary.

Two independent time delays are provided for the configured action to take place and be reset.



Please do not use the output of an equation as input at the same time. Such a configuration could decrease the performance of the interface.

Structure and description of the LogicsManager

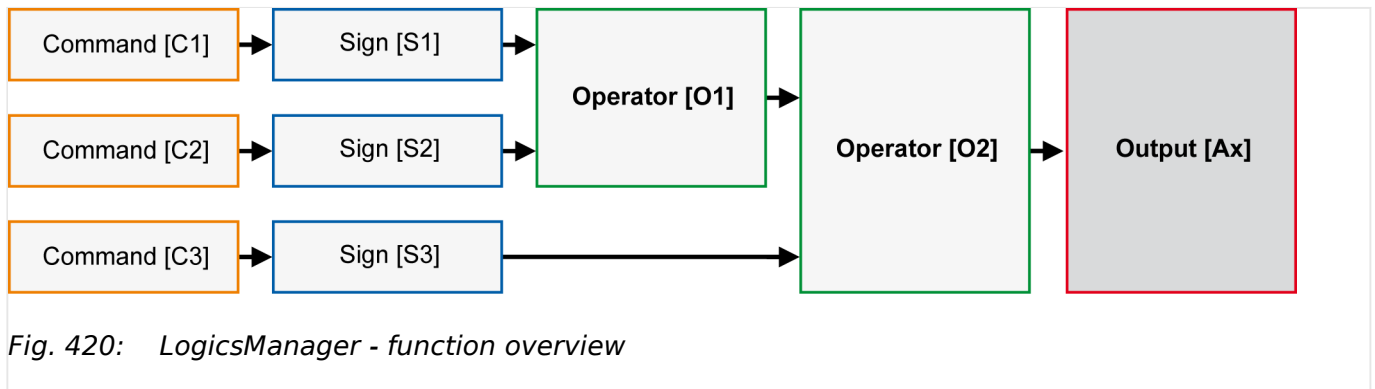

Fig. 420: LogicsManager - function overview

- **Command (variable)**

A list of over 400 parameters and functions is provided for the command inputs.

Examples of the parameters that may be configured into these commands are generator undervoltage thresholds 1 and 2, start fail, and cool down.

These command variables are used to control the output function or relay.

Refer to [“9.3.2 Logical Command Variables”](#) for a complete list of all command variables.

- **Sign**

The sign field can be used to invert the state of the command or to fix its output to a logical true or false if the command is not needed. Setting the sign to the NOT state changes the output of the command variable from true to false or vice versa.

- **Operator**

A logical device such as AND or OR.

- **(Logical) output**

The action or control sequence that occurs when all parameters set into the LogicsManager are met.

For a complete list of all logical outputs refer to [“9.3.4 Logical Outputs”](#).

[Sx] - Sign {x}		
	Value {[Cx]}	The value [Cx] is passed 1:1.
	NOT Value {[Cx]}	The opposite of the value [Cx] is passed.
	0 [False; always "0"]	The value [Cx] is ignored and this logic path will always be FALSE.
	1 [True; always "1"]	The value [Cx] is ignored and this logic path will always be TRUE.

Table 158: Signs

[Ox] - Operator {x}	
AND	Logical AND

[Ox] - Operator {x}	
NAND	Logical negated AND
OR	Logical OR
NOR	Logical negated OR
XOR	Exclusive OR
NXOR	Exclusive negated OR

Table 159: Operators

 For the various display formats of the corresponding logical symbols refer to [“9.3.3 Logical Symbols”](#).

Configuration of the command chain

Using the values specified in the above table, the chain of commands of the LogicsManager (for example: operating the relays, setting the flags, specification of the automatic functions) is configured as follows:

$$[Ax] = (([C1] \& [S1]) \& [O1] \& ([C2] \& [S2])) \& [O2] \& ([C3] \& [S3])$$

 **Programming example for the LogicsManager**

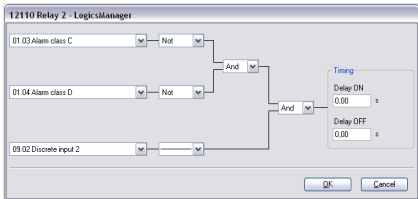

Fig. 421: Programming example (ToolKit)

- Relay [R2] shall energize, whenever "Discrete input [DI 02]" is energized "AND" the control does "NOT" have a fault that is "Alarm class C" "AND" does "NOT" have a fault that is "Alarm class D"

The logical command variables are grouped into different categories.

Part 1: LM variables (1 to 39)

Part 2: LM variables (40 to 79)

Part 3: AM and LM results (80 to 99)

 **Cascading: Use digital results**

This digital **results** of AnalogManagers and LogicsManagers are available as LogicsManager Variables additionally. Like the other LM Variables they can be used as input signal for (further) AnalogManagers or LogicsManagers. The calculation of cascading goes in the sequence from 80 to 99.

9.3.2 Logical Command Variables

9.3.2.1 Group 01: Global alarms

For the description of the alarm classes refer to chapter 'Alarm classes'.

HMI Text	Note
01.01 Alarm class A	TRUE as long as an alarm of alarm class A is active or latched.
01.02 Alarm class B	TRUE as long as an alarm of alarm class B is active or latched.
01.03 Alarm class C	TRUE as long as an alarm of alarm class C is active or latched.
01.04 Alarm class D	TRUE as long as an alarm of alarm class D is active or latched.
01.05 Alarm class E	TRUE as long as an alarm of alarm class E is active or latched.
01.06 Alarm class F	TRUE as long as an alarm of alarm class F is active or latched.
01.07 All alarm classes	TRUE as long as at least one alarm of the alarm classes A/B/C/D/E/F is active or latched.
01.08 Warning alarm	TRUE as long as at least one alarm of the alarm classes A/B is active or latched.
01.09 Shutdown alarm	TRUE as long as at least one alarm of the alarm classes C/D/E/F is active or latched.
01.10 Centralized alarm	TRUE as long as at least one alarm of the alarm classes B/C/D/E/F is active or latched.
01.11 New alarm triggered	TRUE if any alarm of the Alarm classes B/C/D/E/F has been triggered until it is acknowledged.

9.3.2.2 Group 02: System conditions

HMI Text	Note
02.01 LM FALSE	Fixed value - often used for default setting
02.02 LM TRUE	Fixed value - often used for default setting
02.03 Gen. voltage ok	TRUE as long as the generator voltage is within the operating range.

HMI Text	Note
02.04 Gen. frequency ok	TRUE as long as the generator frequency is within the operating range.
02.05 Gen. volt./freq. ok	TRUE as long as the generator voltage and frequency are within the operating ranges (02.03. and 02.04 are TRUE).
02.06 Busbar 1 voltage ok	TRUE as long as the busbar 1 voltage is within the generator voltage operating range.
02.07 Busbar 1 freq. ok	TRUE as long as the busbar 1 frequency is within the generator frequency operating range.
02.08 Busb1 volt./freq. ok	TRUE as long as the busbar 1 voltage and frequency are within the generator operating ranges (02.06. and 02.07 are TRUE).
02.09 Mains voltage ok	TRUE as long as the mains voltage is within the operating range. This command variable is derived from the easYgen mains measurement, not from the LS5!
02.10 Mains frequency ok	TRUE as long as the mains frequency is within the operating range. This command variable is derived from the easYgen mains measurement, not from the LS5!
02.11 Mains volt./freq. ok	TRUE as long as the mains voltage and frequency are within the operating ranges (02.09. and 02.10 are TRUE). This command variable is derived from the easYgen mains measurement, not from the LS5!
02.12 Gen. rotation CCW	TRUE as long as the respective rotation field is detected in case of a three-phase voltage measurement at the respective measuring location.
02.13 Gen. rotation CW	TRUE as long as the respective rotation field is detected in case of a three-phase voltage measurement at the respective measuring location.
02.14 Mains rotation CCW	TRUE as long as the respective rotation field is detected in case of a three-phase voltage measurement at the respective measuring location. These command variables are derived from the easYgen mains measurement, not from the LS5!
02.15 Mains rotation CW	TRUE as long as the respective rotation field is

HMI Text	Note
	detected in case of a three-phase voltage measurement at the respective measuring location. These command variables are derived from the easYgen mains measurement, not from the LS5!
02.16 Busb.1 rotation CCW	TRUE as long as the respective rotation field is detected in case of a three-phase voltage measurement at the respective measuring location.
02.17 Busbar 1 rotation CW	TRUE as long as the respective rotation field is detected in case of a three-phase voltage measurement at the respective measuring location.
02.21 Dead busbar1	TRUE as long as the busbar voltage is below the value configured in parameter 5820 (Dead bus detection max. volt.)
02.29 Sync.Check gen./busb	Synchronize Check Relay: Generator / Busbar (ANSI 25) TRUE, if all of the following ranges matches: <ul style="list-style-type: none"> • voltage • frequency • phase angle • acceleration range • lead angle
02.32 Sync.Check mns/busb	Synchronize Check Relay: Mains / Busbar (ANSI 25) TRUE, if all of the following ranges matches: <ul style="list-style-type: none"> • voltage • frequency • phase angle • acceleration range • lead angle
02.34 Firing speed electr.	True if generator frequency value matches firing speed.
02.35 Firing speed rpm	True if rpm (via MPU or J1939) value matches firing speed.
02.36 Speed electr.	True if generator frequency value matches speed detected.
02.37 Speed rpm	True if rpm (via MPU or J1939) value matches speed detected.
02.38 Gen excitation lim.	TRUE if generator excitation limit has exceeded.
02.39 Mains decoupl.enabl.	TRUE if "3110 Mains decoupling" is

HMI Text	Note
	not Off and "87.31 LM: Enable Mns dec." is TRUE
02.40 Own GC not recognized	TRUE if own GC is not recognized.
02.41 GC Inhibit DBCL GCB	TRUE if a GC requires to block dead bus closure of the GCB.
02.42 GC Neighbor GC miss.	TRUE if a GC has detected that at least one GC is missing.
02.43 GC any EG is missing	TRUE if a GC have detected that at least one easYgen is missing in at least one group.
02.44 GC Droop request	TRUE if 02.42 Or 02.43 is TRUE. It is recommended to or this flag for the droop.
02.45 Mns.release breaker	TRUE if mains breaker reconnection is released.
02.46 f dep.power change	True if frequency depending up- or derating is active.

9.3.2.3 Group 03: Engine control

HMI Text	Note
03.01 Auxiliary services	TRUE if an auxiliary services prerun or postrun is enabled.
03.02 Starter	TRUE if the starter relay is energized.
03.04 Preglow / Ignition	TRUE if Preglow (Diesel engine) or Ignition (Gas engine) is active.
03.05 Horn	True if a new alarm (higher A) is triggered and time (parameter 1756) for horn reset has not exceeded.
03.06 Engine released	TRUE if the engine is requested and the start is released.
03.07 Engine delay expired	TRUE after expiration of the "delayed engine monitoring" timer until the fuel relay is de-energized.
03.08 Break. delay expired	TRUE after expiration of the Generator Stable Time until the fuel relay is de-energized. (Breaker actions are not permitted anymore.)
03.13 Blinking lamp ECU	TRUE as soon as the ECU activates the diagnosis light (only for Scania S6 ECU). This command variable is only active if remote control of the ECU via easYgen is activated.
03.14 ECU special ignition	TRUE as long as a reset or read-out of the Scania S6 ECU blink code is requested (only for S6 Scania ECU). This command variable is only active if remote control of the ECU via easYgen is activated.
03.15 ECU seq. B_OUT_1	This flag is for special ECU indications:
03.16 ECU seq. B_OUT_2	This flag is for special ECU indications:

HMI Text	Note
03.17 ECU seq. B_OUT_3	This flag is for special ECU indications: Scania S8: "Power Lost Due to High Temperature"
03.18 ECU seq. B_OUT_4	This flag is for special ECU indications: Scania S8: "Low Urea Level"
03.20 Governor raise	TRUE if the "Three Position Controller Frequency / Active Power" raise pulse is active.
03.21 Governor lower	TRUE if the "Three Position Controller Frequency / Active Power" lower pulse is active.
03.22 AVR raise	TRUE if the "Three Position Controller Output Voltage / Reactive Power" raise pulse is active.
03.23 AVR lower	TRUE if the "Three Position Controller Output Voltage / Reactive Power" lower pulse is active.
03.24 Excitation enabled	TRUE if excitation is enabled.
03.25 Engine shall run	TRUE if engine start conditions are fulfilled.
03.27 Stop solenoid	TRUE if a stop signal is issued until the stop time of engine expires
03.28 Start/Gas	TRUE if the fuel solenoid (Diesel) or gas valve (gas) is released.
03.30 Aux. serv. prerun	TRUE if "Auxiliary services prerun" is active
03.31 Aux. serv. postrun	TRUE if "Auxiliary services postrun" is active
03.32 + PID1 controller	TRUE if the "Free PID 1" raise pulse is active.
03.33 - PID1 controller	TRUE if the "Free PID 1" lower pulse is active.
03.34 + PID2 controller	TRUE if the "Free PID 2" raise pulse is active.
03.35 - PID2 controller	TRUE if the "Free PID 2" lower pulse is active.
03.36 + PID3 controller	TRUE if the "Free PID 3" raise pulse is active.
03.37 - PID3 controller	TRUE if the "Free PID 3" lower pulse is active.
03.38 Inhibit cranking	TRUE if inhibit cranking is activated
03.39 Close neutral cont.	TRUE if neutral contactor close command is active.
03.40 Remote Shutdown	TRUE if remote shutdown (ID 503, Bit 9) is active.
03.41 Aux. excit. 12V act.	TRUE if auxilliary excitation D+ 12 V is active.
03.42 Aux. excit. 24V act.	TRUE if auxilliary excitation D+ 24 V is active.
03.44 Protection lamp DM1	TRUE if ECU Protection lamp DM1 (SPN 987) is active.
03.45 Emission lamp DM1	TRUE if ECU Emission lamp DM1 (SPN 1213) is active.
03.46 DPF lamp solid on	TRUE if ECU Diesel Particulate Filter Lamp Command: ON solid (SPN 3697) is active.
03.47 DPF lamp fast blink	TRUE if ECU Diesel Particulate Filter Lamp Command: fast blinking (SPN 3697) is active.
03.48 DPF regenerat.active	TRUE if ECU Diesel Particulate Filter Active Regeneration Status: active (SPN 3700) is active.
03.49 DPF regenerat.needed	TRUE if ECU Diesel Particulate Filter Active Regeneration Status: regeneration needed (SPN 3700) is active.

HMI Text	Note
03.50 DPF reg. needed low	TRUE if ECU Diesel Particulate Filter Status: Regeneration needed: lowest level (SPN 3701) is active.
03.51 DPF reg. needed mod.	TRUE if ECU Diesel Particulate Filter Status: Regeneration needed: moderate level (SPN 3701) is active.
03.52 DPF reg. needed high	TRUE if ECU Diesel Particulate Filter Status: Regeneration needed: highest level (SPN 3701) is active.
03.53 Exh. temp. lamp on	TRUE if ECU Exhaust System High Temperature Lamp Command: on (SPN 3698) is active.
03.54 Wait to start lamp	TRUE if ECU Engine Wait to Start Lamp: on (SPN 1081) is active. (In Deutz EMR mode: Preheat active.)
03.57 DPF:Pass.regeneration	TRUE if ECU Diesel Particulate Filter Passive Regeneration Status: Active (SPN 3699) is active.
03.58 DPF:Act.reg.inhibit	TRUE if ECU Diesel Particulate Filter Active Regeneration Inhibited Status: Inhibited (SPN 3702) is active.
03.73 Restored oper. active	(03.73 to 03.85 are for Volvo EMS2. Only as command variables available.) State of 15859 "Restored operation": "Restored operation active"
03.74 Restored oper. error	State of 15859 "Restored operation": "Restored operation error"
03.75 SCR: no inducement	State of 15857 "SCR inducement severity": "No inducement active"
03.76 SCR: warning	State of 15857 "SCR inducement severity": "Inducement warning"
03.77 SCR: derate active	State of 15857 "SCR inducement severity": "Derate active"
03.78 SCR: derate! warning	State of 15857 "SCR inducement severity": "Pre severe derate warning"
03.79 SCR: severe derate!	State of 15857 "SCR inducement severity": "Severe derate"
03.80 SCR: override derate	State of 15857 "SCR inducement severity": "Temporary override of derate"
03.81 SCR: OK	State of 15858 "SCR inducement reason": "OK"
03.82 SCR: Tank level low	State of 15858 "SCR inducement reason": "Reagent tank low level"
03.83 SCR: Reagent quality	State of 15858 "SCR inducement reason": "Incorrect reagent quality"
03.84 SCR: Absence dosing	State of 15858 "SCR inducement reason": "Absence of reagent dosing"
03.85 SCR: Tampering	State of 15858 "SCR inducement reason": "Tampering"
03.86 DPF1 Act.reg.inhibit	"Active DPF regeneration inhibited" (SPN 3750 DPF1 Conditions Not Met for Active Regeneration.)
03.87 Inhibit Switch	(SPN 3703 DPF regeneration inhibited due to Inhibit Switch.)
03.88 Low exhaust temp.	(SPN 3711 DPF regeneration inhibited due to Low Exhaust Gas Temperature.)
03.89 System fault active	Inhibited Switch (SPN 3712 DPF regeneration inhibited due to System fault.)
03.90 System timeout	Inhibited Switch (SPN 3713 DPF regeneration inhibited due to System Timeout.)
03.91 Temporary lockout	Inhibited Switch (SPN 3714 DPF regeneration inhibited due to Temporary System Lockout.)
03.92 Permanent lockout	Inhibited Switch (SPN 3715 DPF regeneration inhibited due to Permanent System Lockout.)
03.93 Engine not warmed up	Inhibited Switch (SPN 3716 DPF regeneration inhibited due to Engine Not Warmed Up.)

HMI Text	Note
03.94 Low exhaust pressure	Inhibited Switch (SPN 5466 DPF regeneration inhibited due to Low Exhaust Gas Pressure.)

9.3.2.4 Group 04: Application conditions

HMI Text	Note
04.01 Operat. mode AUTO	TRUE if operating mode AUTOMATIC is active.
04.02 Operat. mode STOP	TRUE if operating mode STOP is active.
04.03 Operat. mode MAN	TRUE if operating mode MANUAL is active.
04.04 Operat. mode TEST	TRUE if operating mode TEST is active.
04.05 Acknowledge	TRUE if "Acknowledge" push button has been pressed or an external acknowledgment via LogicsManager is active. (This condition is TRUE for approx. 40 ms and must be extended utilizing a delay time.)
04.06 GCB closed	TRUE if DI 8 (Reply GCB) is de-energized.
04.07 MCB closed	TRUE if DI 7 (Reply MCB) is de-energized.
04.09 Emergency mode	TRUE if the emergency "Mains fail delay time" has exceeded. False if the MCB is closed after the mains settling time.
04.10 Cool down	TRUE as long as the cool down time is running.
04.11 Mains settling	TRUE if a mains failure detected. FALSE if the mains settling timer has expired.
04.12 Start w/o load	TRUE if start without closing GCB is active.
04.13 Remote request	TRUE if a remote start request is active (Control word 503)
04.14 Remote acknowledge	TRUE if a remote acknowledge is active (Control word 503)
04.15 Idle run active	TRUE if the idle mode is active. This may be used to issue an "Idle" command to a speed controller.
04.16 GGB closed	TRUE if DI 9 (Reply GGB) is de-energized
04.17 GGB released	TRUE if GGB is released.
04.18 Synchron. GCB active	TRUE if the GCB shall be synchronized.
04.19 Opening GCB relay act	TRUE if the GCB open relay is energized.
04.20 Closing GCB active	TRUE if the GCB close relay is energized.
04.21 Syn. MCB is active	TRUE if the MCB shall be synchronized.
04.22 Opening MCB active	TRUE if an MCB open command is active.
04.23 Closing MCB active	TRUE if an MCB close command is active.
04.24 Syn. GGB active	TRUE if the GGB shall be synchronized.
04.25 Opening GGB active	TRUE if a GGB open command is active.
04.26 Closing GGB active	TRUE if a GGB close command is active.

HMI Text	Note
04.27 Critical mode	TRUE if critical mode is enabled
04.28 Generator unloading	TRUE if generator is unloading.
04.29 Mains unloading	TRUE if mains unloading is active.
04.30 Limited prerun	TRUE if prerun with warm up load limitation is active.
04.31 Segment no.2 act.	TRUE if the result LM "12929 segment number 2" is true.
04.32 Segment no.3 act.	TRUE if the result LM "12928 segment number 3" is true. (LM 12929 has priority.)
04.33 Segment no.4 act.	TRUE if the result LM "12927 segment number 4" is true. (LMs 12929, 12928 have priority.)
04.34 LDSS Priority 2	TRUE if the result of LM "12926 LDSS Priority 2" is true.
04.35 LDSS Priority 3	TRUE if the result of LM "12925 LDSS Priority 3" is true. (LM 12926 has priority.)
04.36 LDSS Priority 4	TRUE if the result of LM "12924 LDSS Priority 3" is true. (LMs 12926, 12925 have priority.)
04.37 Remote volt. setp. 2	TRUE if "Request Voltage Setpoint 2" is set via interface (control word 504).
04.38 Remote freq. setp. 2	TRUE if "Request Frequency Setpoint 2" is set via interface (control word 504).
04.39 Remote PF setp. 2	TRUE if "Request Power Factor Setpoint 2" is set via interface (control word 504).
04.40 Remote pwr. setp. 2	TRUE if "Request Active Power Setpoint 2" is set via interface (control word 504).
04.41 Transition mode 1	TRUE if the result LM "12931 Transition mode 1" is true.
04.42 Transition mode 2	TRUE if the result LM "12932 Transition mode 2" is true. (LM 12931 has priority.)
04.43 LD start stop	TRUE if LDSS is active (Main conditions: the result LM "12930 Load dependent start/stop" is true, "Operation mode" is automatic and engine shall run.
04.44 RemoteControl Bit 1	TRUE if remote control bit 1 is activated. (Control word 505)
04.45 RemoteControl Bit 2	TRUE if remote control bit 2 is activated. (Control word 505)
04.46 RemoteControl Bit 3	TRUE if remote control bit 3 is activated. (Control word 505)
04.47 RemoteControl Bit 4	TRUE if remote control bit 4 is activated. (Control word 505)
04.48 RemoteControl Bit 5	TRUE if remote control bit 5 is activated. (Control word 505)
04.49 RemoteControl Bit 6	TRUE if remote control bit 6 is activated. (Control word 505)
04.50 RemoteControl Bit 7	TRUE if remote control bit 7 is activated. (Control word 505)
04.51 RemoteControl Bit 8	TRUE if remote control bit 8 is activated. (Control word 505)
04.52 RemoteControl Bit 9	TRUE if remote control bit 9 is activated. (Control word 505)
04.53 RemoteControl Bit 10	TRUE if remote control bit 10 is activated. (Control word 505)

HMI Text	Note
04.54 RemoteControl Bit 11	TRUE if remote control bit 11 is activated. (Control word 505)
04.55 RemoteControl Bit 12	TRUE if remote control bit 12 is activated. (Control word 505)
04.56 RemoteControl Bit 13	TRUE if remote control bit 13 is activated. (Control word 505)
04.57 RemoteControl Bit 14	TRUE if remote control bit 14 is activated. (Control word 505)
04.58 RemoteControl Bit 15	TRUE if remote control bit 15 is activated. (Control word 505)
04.59 RemoteControl Bit 16	TRUE if remote control bit 16 is activated. (Control word 505)
04.60 Crit. mode postrun	TRUE as long as the critical mode postrun time is running.
04.61 Lamp test	TRUE if lamp test is active.
04.62 Act.pwr.LS active	TRUE if load share of active power is active.
04.63 React.pwr.LS active	TRUE if load share of reactive power is active.
04.64 Key activation	TRUE as long as the "Key activation time" is running. Only relevant for versions with front panel (HMI).
04.65 System update active	TRUE if System Update (teach in process) is active.
04.66 Mains failure ended	TRUE if "Mains Settling Time" is triggered OR mains frequency dependent power up-/derating becomes deactive. Reset if power setpoint after resynchronization is reached OR GCB is opened OR mains is ok again for the time configured with parameter 5015.
04.67 Reserve power avail.	TRUE if reserve power is available.
04.68 ATS start request	TRUE if LDSS with predicted load wants to start the engines. This command variable can be assigned to the LM "Start request in AUTO"
04.69 Inhibit ATS	TRUE if "04.68 ATS start request" is true and the rated power on the bus bar is lower than the predicted load. It shall be passed to a relay to inhibit the ATS control to switch load in any direction.
04.70 Opening GCB active	TRUE if the GCB is to be opened. (Independent of the relay NC/NO.)
04.71 GC LDSS start request	TRUE if the GC is requesting a LDSS start.
04.73 Run-up synch.finished	TRUE if Run-up synchronization is finished. It stays TRUE until the Engine is stopped.
04.74 PV load ref. 0%	TRUE if the PV inverter shall be limited to 0 % of rated.
04.75 PV load ref. 30%	TRUE if the PV inverter shall be limited to 30 % of rated.
04.76 PV load ref. 60%	TRUE if the PV inverter shall be limited to 60 % of rated.
04.77 PV load ref. 100%	TRUE if the PV inverter shall provide up to 100 % of rated.
04.87 Min. one GCB closed	One or more closed GCB in the system.

9.3.2.5 Group 05: Engine related alarms

TRUE if the alarm is active or latched.

HMI Text	Note
05.01 Overspeed 1	Engine Over speed threshold 1
05.02 Overspeed 2	Engine Over speed threshold 2
05.03 Underspeed 1	Engine Under speed threshold 1
05.04 Underspeed 2	Engine Under speed threshold 2
05.05 Unintended stop	Unintended shutdown
05.06 Eng. stop malfunc.	Shutdown malfunction
05.07 Speed/freq. mismatch	Pickup speed / Frequency mismatch
05.08 Start fail	Start failure
05.09 Maint. days exceeded	Maintenance days exceeded
05.10 Maint. hrs exceeded	Maintenance hours exceeded
05.11 Charge alt. low volt	Charge Alternator D+ low voltage
05.13 Red stop lamp	ECU red stop lamp
05.14 Amber warning lamp	ECU amber/yellow stop lamp
05.16 Derating active	Free derating or J1939 derating (event, no alarm)
05.17 Uprating active	Uprating active (event, no alarm)
05.18 Cyl.tmp.lev.1	Cylinder temperature level 1
05.19 Cyl.tmp.lev.2	Cylinder temperature level 2
05.20 Cyl.tmp.wire brk.	Cylinder temperature wire break
05.22 ECU Protect lamp AL	ECU protect lamp
05.23 ECU Emission lamp AL	ECU emission (malfunction) lamp

9.3.2.6 Group 06: Generator related alarms

TRUE if the alarm is active or latched.

HMI Text	Note
06.01 Gen. overfrequency 1	Generator over frequency threshold 1
06.02 Gen. overfrequency 2	Generator over frequency threshold 2
06.03 Gen.underfrequency 1	Generator under frequency threshold 1
06.04 Gen.underfrequency 2	Generator under frequency threshold 2
06.05 Gen. overvoltage 1	Generator over voltage threshold 1
06.06 Gen. overvoltage 2	Generator over voltage threshold 2
06.07 Gen. undervoltage 1	Generator under voltage threshold 1
06.08 Gen. undervoltage 2	Generator under voltage threshold 2
06.09 Gen. overcurrent 1	Generator over current threshold 1
06.10 Gen. overcurrent 2	Generator over current threshold 2

HMI Text	Note
06.11 Gen. overcurrent 3	Generator over current threshold 3
06.12 Gen. rev./red. pwr.1	Reverse / reduced power threshold 1
06.13 Gen. rev./red. pwr.2	Reverse / reduced power threshold 2
06.14 Gen. overload IOP 1	Generator overload IOP threshold 1
06.15 Gen. overload IOP 2	Generator overload IOP threshold 2
06.16 Unbalanced load 1	Generator unbalanced load threshold 1
06.17 Unbalanced load 2	Generator unbalanced load threshold 2
06.18 Gen. volt. asymmetry	Generator voltage asymmetry
06.19 Ground fault 1	Ground fault threshold 1
06.20 Ground fault 2	Ground fault threshold 2
06.21 Gen.ph.rot. mismatch	Generator Phase Rotation mismatch
06.22 Inv. time overcurr.	Inverse time over current
06.23 Gen. overload MOP 1	Generator overload MOP threshold 1
06.24 Gen. overload MOP 2	Generator overload MOP threshold 2
06.25 Gen. PF lagging 1	Generator Power Factor lagging 1
06.26 Gen. PF lagging 2	Generator Power Factor lagging 2
06.27 Gen. PF leading 1	Generator Power Factor leading 1
06.28 Gen. PF leading 2	Generator Power Factor leading 2
06.29 Gen.act.pwr.mismatch	Generator active power mismatch
06.30 Gen. unload.mismatch	Generator unloading mismatch
06.31 Operat. range failed	Operating Range failed
06.32 Gen. AC wiring	Generator AC wiring plausibility
06.33 Busbar 1 AC wiring	Busbar 1 AC wiring plausibility
06.34 Busb.ph.rot.mismatch	Busbar phase rotation mismatch
06.36 Pole slip	Gen pole slip monitoring
06.37 Open diode fault	J1939 AVR: Open diode fault
06.38 Shorted diode fault	J1939 AVR: Shortened diode fault
06.39 Power supply fault	J1939 AVR: Power supply fault
06.40 IGBT fault	J1939 AVR: IGBT fault
06.41 Power bridge fault	J1939 AVR: Power bridge overload fault

9.3.2.7 Group 07: Mains related alarms

TRUE if the alarm is active or latched.

HMI Text	Note
07.05 Mns.ph.rot. mismatch	Mains Phase rotation mismatch
07.06 Mains overfreq. 1	Mains over frequency threshold 1
07.07 Mains overfreq. 2	Mains over frequency threshold 2

HMI Text	Note
07.08 Mains underfreq. 1	Mains under frequency threshold 1
07.09 Mains underfreq. 2	Mains under frequency threshold 2
07.10 Mains overvoltage 1	Mains over voltage threshold 1
07.11 Mains overvoltage 2	Mains over voltage threshold 2
07.12 Mains undervoltage 1	Mains under voltage threshold 1
07.13 Mains undervoltage 2	Mains under voltage threshold 2
07.14 Mains phase shift	Mains Phase shift
07.15 Mains df/dt	Mains df/dt (Change of frequency)
07.16 Mns.act.pwr.mismatch	Mains active power mismatch
07.17 Mains PF lagging 1	Mains Power Factor inductive 1
07.18 Mains PF lagging 2	Mains Power Factor inductive 2
07.19 Mains PF leading 1	Mains Power Factor capacitive 1
07.20 Mains PF leading 2	Mains Power Factor capacitive 2
07.21 Mains import power 1	Mains import power threshold 1
07.22 Mains import power 2	Mains import power threshold 2
07.23 Mains export power 1	Mains export power threshold 1
07.24 Mains export power 2	Mains export power threshold 2
07.25 Mains decoupling	Mains decoupling
07.27 Mains volt.incr.	Mains slow voltage (10 minutes moving average)
07.28 Time-dep. voltage 1	Time-dependent voltage monitoring 1 (FRT)
07.29 QV monitoring 1	QV Monitoring step 1
07.30 QV monitoring 2	QV Monitoring step 2
07.31 Time-dep. voltage 2	Time-dependent voltage monitoring 2 (FRT)
07.32 Mains AC wiring	Mains AC wiring plausibility
07.33 Time-dep. voltage 3	Time-dependent voltage monitoring 3 (FRT)
07.34 FRT ROCOF enable	This flag is FALSE if any "Time-dependent voltage monitoring" (FRT) is initialized. Otherwise it is TRUE. It can be used to block temporary "Phase shift" and "df/dt" monitoring if FRT is initialized. . (This is no alarm, only a LM.)
07.35 FRT Q/V curve	TRUE if "Voltage control" is configured to AVR and FRT is excited and "6658 Delay FRT SP" has exceeded. (No indication in HMI and Toolkit. This is no alarm, only a LM.)
07.36 2nd Q PID in FRT	TRUE if 07.35 is true and "6659 2nd PID Q Limit FRT" is undercut. (No indication in HMI and Toolkit. .This is no alarm, only a LM.)
07.37 LSx Syst. A rot. CW	LSx System A: phase rotation CW. Usable in dedicated LSx modes: GCB/L-MCB, GCB/GGB/L-MCB, GCB/L-GGBMCB, GCB/L-GGB/L-MCB. The value comes from the mains LSx (device number 33) connected with system A on mains. (Active, not latched)

HMI Text	Note
07.38 LSx Syst. A rot. CCW	LSx System A: phase rotation CCW. Usable in dedicated LSx modes: GCB/L-MCB, GCB/GGB/L-MCB, GCB/L-GGBMCB, GCB/L-GGB/L-MCB. The value comes from the mains LSx (device number 33) connected with system A on mains. (Active, not latched)
07.39 LSx Syst. B rot. CW	LSx System B: phase rotation CW. Usable in dedicated LSx modes: GCB/L-MCB, GCB/GGB/L-MCB, GCB/L-GGBMCB, GCB/L-GGB/L-MCB. The value comes from the mains LSx (device number 33) connected with system A on mains. (Active, not latched)
07.40 LSx Syst. B rot. CCW	LSx System B: phase rotation CCW. Usable in dedicated LSx modes: GCB/L-MCB, GCB/GGB/L-MCB, GCB/L-GGBMCB, GCB/L-GGB/L-MCB. The value comes from the mains LSx (device number 33) connected with system A on mains. (Active, not latched)
07.41 LSx System A ok	LSx System A is ok. System A is in the operating ranges. Usable in all LSx modes and GC mode. The value comes only from the LSx device number 33. (Active, not latched)
07.42 LSx System B ok	LSx System B is ok. System B is in the operating ranges. Usable in all LSx modes and GC mode. The value comes only from the LSx device number 33. (Active, not latched)
07.43 LSx Mains voltage	LSx Mains Voltage is ok. This flag is true if the measured mains voltage of the LSx with the smallest device number is higher than 50 % of the rated mains voltage configured in the easYgen. (Active, not latched)

9.3.2.8 Group 08: Syst. related alarms

TRUE if the alarm is active or latched.

HMI Text	Note
08.01 Bat. overvoltage 1	Battery over voltage threshold 1
08.02 Bat. overvoltage 2	Battery over voltage threshold 2
08.03 Bat. undervoltage 1	Battery under voltage threshold 1
08.04 Bat. undervoltage 2	Battery under voltage threshold 2
08.05 GCB fail to close	GCB close not successful
08.06 GCB fail to open	GCB open not successful
08.07 MCB fail to close	MCB close not successful
08.08 MCB fail to open	MCB open not successful
08.10 CAN fault J1939	CAN J1939 communication alarm (Becomes true if at least one of the CVs 08.37-08.40 becomes true.)
08.16 Parameter alignment	Parameter Alignment LDSS
08.17 Missing members	Number of members mismatched

HMI Text	Note
08.18 CANopen Interface 1	CANopen error interface 1
08.19 CANopen Interface 2	CANopen error interface 2
08.22 Busbar v/f not ok	Busbar voltage or frequency is not ok.
08.27 Missing easYgen	At least one easYgen is missing.
08.28 Missing LSx	At least one LSx (Layer 1) is missing.
08.29 CANopen Interface 3	CANopen error interface 3
08.30 Synchron. time GCB	Timeout Synchronization GCB
08.31 Synchron. time MCB	Timeout Synchronization MCB
08.32 Synchron. time GGB	Timeout Synchronization GGB
08.34 GGB fail to close	GGB close not successful
08.35 GGB fail to open	GGB open not successful
08.37 J1939 ECU timeout	CAN J1939 ECU timeout
08.38 J1939 dev. 1 timeout	CAN J1939 device 1 timeout
08.39 J1939 dev. 2 timeout	CAN J1939 device 2 timeout
08.40 J1939 dev. 3 timeout	CAN J1939 device 3 timeout
08.41 Ethernet B LS fault	Ethernet B loadshare fault if load sharing with Ethernet B is selected and no device detected. (This is no alarm, only a LM.)
08.42 Ethernet C LS fault	Ethernet C loadshare fault if load sharing with Ethernet C is selected and no device detected. (This is no alarm, only a LM.)
08.43 Syst.update easYgen	System update easYgen There is an easYgen detected in the communication network which is not taught in (A system update is required)
08.44 Syst.update LSx	System update LSx There is a LSx detected in the communication network which is not taught in. (A system update is required)
08.45 CPU overload R1 trip	CPU overload R1 trip (alarm class B, not selfackn.) becomes active if CPU overload is longer than 10s.
08.46 GCB failure 50BF	GCB failure 50BF
08.47 MCB failure 50BF	MCB failure 50BF
08.48 MCB plausibility	MCB plausibility
08.50 Syst.upd.r/y twinkle	System update red or yellow LED twinkling Red twinkle: if there is no device recognized according to the last system update. Yellow twinkle: if there is no device detected according to the last system update on one redundant interface. (This is no alarm, only a LM.)
08.51 CAN LS fault	CAN loadshare fault if load sharing with CAN is selected and no device detected. (This is no alarm, only a LM.)
08.52 Ethernet A LS fault	Ethernet A loadshare fault if load sharing with Ethernet A is selected and no device detected. (This is no alarm, only a LM.)
08.53 EthB EthC redundancy	Load share interface redundancy (Ethernet B/C) lost

HMI Text	Note
08.54 Eth. configuration	Ethernet configuration mismatch There is configuration mismatch between Eth A/B OR Eth. A/C OR Eth. B/C
08.62 Ethernet issue	Ethernet issue (E.g. broadcast storm)
08.65 Syst.update Layer 1	System Update Layer 1 There is a device detected in the layer 1 communication network which is not taught in. (A system update is required.)
08.66 Syst.update Layer 3	System Update Layer 3 There is a device detected in the layer 3 communication network which is not taught in. (A system update is required.)
08.70 CAN EthA redundancy	Load share interface redundancy CAN1 / Ethernet A lost
08.71 PV disconnect	PV disconnect level under run
08.72 Modbus dev.1 timeout	Modbus Master communication timeout device 1 (This is no alarm, only a LM.)
08.73 Modbus dev.2 timeout	Modbus Master communication timeout device 2 (This is no alarm, only a LM.)
08.74 Modbus dev.3 timeout	Modbus Master communication timeout device 3 (This is no alarm, only a LM.)
08.75 Modbus dev.4 timeout	Modbus Master communication timeout device 4 (This is no alarm, only a LM.)
08.76 Modbus dev.5 timeout	Modbus Master communication timeout device 5 (This is no alarm, only a LM.)
08.77 J1939 AVR timeout	CAN J1939 AVR timeout or (only for AVRbridge-10-P1) remote configuration error
08.78 easYgen LS timeout	No received loadshare message for a specified timeout of any teachd in easYgen
08.79 LSx LS timeout	No received loadshare message for a specified timeout of any teachd in LSx
08.80 Redundancy LS timeout	No received loadshare message (of one of the redundant interfaces) for a specified timeout of any teachd in device

9.3.2.9 Group 09: Alarms discrete inputs

TRUE if the alarm is active or latched.

HMI Text	Note
09.01 Discrete input 1	
09.02 Discrete input 2	
09.03 Discrete input 3	
09.04 Discrete input 4	
09.05 Discrete input 5	
09.06 Discrete input 6	
09.07 Discrete input 7	
09.08 Discrete input 8	
09.09 Discrete input 9	

HMI Text	Note
09.10 Discrete input 10	
09.11 Discrete input 11	
09.12 Discrete input 12	
09.13 Discrete input 13	
09.14 Discrete input 14	
09.15 Discrete input 15	
09.16 Discrete input 16	
09.17 Discrete input 17	
09.18 Discrete input 18	
09.19 Discrete input 19	
09.20 Discrete input 20	
09.21 Discrete input 21	
09.22 Discrete input 22	
09.23 Discrete input 23	

9.3.2.10 Group 10: Alarms analog inputs

TRUE if the alarm is active or latched.

HMI Text	Note
10.01 AI 1 wire break	Analog Input 1 out of range
10.02 AI 2 wire break	Analog Input 2 out of range
10.03 AI 3 wire break	Analog Input 3 out of range
10.04 AI 4 wire break	Analog Input 4 out of range
10.05 AI 5 wire break	Analog Input 5 out of range
10.06 AI 6 wire break	Analog Input 6 out of range
10.07 AI 7 wire break	Analog Input 7 out of range
10.08 AI 8 wire break	Analog Input 8 out of range
10.09 AI 9 wire break	Analog Input 9 out of range
10.10 AI 10 wire break	Analog Input 10 out of range

9.3.2.11 Group 11: Clock and timer

HMI Text	Note
11.01 Timer 1	TRUE if Timer 1 overrun
11.02 Timer 2	TRUE if Timer 2 overrun
11.03 Active weekday	TRUE if configured weekday is active.
11.04 Active day	TRUE if configured day in month is active.
11.05 Active hour	TRUE if configured hour is active.

HMI Text	Note
11.06 Active minute	TRUE if configured minute is active.
11.07 Active second	TRUE if configured second is active.
11.08 Engine 1h	Running hours 1h over (toggles every running hour)
11.09 Engine 10h	Running hours 10h over (toggles every 10 running hours)
11.10 Engine 100h	Running hours 100h over (toggles every 100 running hours)
11.11 Pulse every 20 ms	Pulse toggling every 20 ms (only for LM system)
11.12 Pulse every 100 ms	Every 100 ms for 20 ms TRUE (only for LM system)
11.13 Pulse every 1000 ms	Every 1000 ms for 20 ms TRUE (only for LM system)
11.14 Timer weekly 1	TRUE if timer weekly 1 is between start and stop condition
11.15 Timer weekly 2	TRUE if timer weekly 2 is between start and stop condition
11.16 Timer weekly 3	TRUE if timer weekly 3 is between start and stop condition
11.17 Timer weekly 4	TRUE if timer weekly 4 is between start and stop condition
11.18 Timer weekly 5	TRUE if timer weekly 5 is between start and stop condition
11.19 Timer weekly 6	TRUE if timer weekly 6 is between start and stop condition
11.20 Timer weekly 7	TRUE if timer weekly 7 is between start and stop condition

9.3.2.12 Group 12: External discrete inputs

TRUE if the alarm is active or latched.

HMI Text	Note
12.01 External DI 1	External discrete input 1
12.02 External DI 2	External discrete input 2
12.03 External DI 3	External discrete input 3
12.04 External DI 4	External discrete input 4
12.05 External DI 5	External discrete input 5
12.06 External DI 6	External discrete input 6
12.07 External DI 7	External discrete input 7
12.08 External DI 8	External discrete input 8
12.09 External DI 9	External discrete input 9
12.10 External DI 10	External discrete input 10
12.11 External DI 11	External discrete input 11
12.12 External DI 12	External discrete input 12
12.13 External DI 13	External discrete input 13
12.14 External DI 14	External discrete input 14
12.15 External DI 15	External discrete input 15
12.16 External DI 16	External discrete input 16
12.17 External DI 17	External discrete input 17
12.18 External DI 18	External discrete input 18

HMI Text	Note
12.19 External DI 19	External discrete input 19
12.20 External DI 20	External discrete input 20
12.21 External DI 21	External discrete input 21
12.22 External DI 22	External discrete input 22
12.23 External DI 23	External discrete input 23
12.24 External DI 24	External discrete input 24
12.25 External DI 25	External discrete input 25
12.26 External DI 26	External discrete input 26
12.27 External DI 27	External discrete input 27
12.28 External DI 28	External discrete input 28
12.29 External DI 29	External discrete input 29
12.30 External DI 30	External discrete input 30
12.31 External DI 31	External discrete input 31
12.32 External DI 32	External discrete input 32

9.3.2.13 Group 13: Discrete outputs (physical state)

TRUE if relay / transistor is energized

HMI Text	Note
13.01 Discrete output 1	Relay 1 (ready for operation)
13.02 Discrete output 2	Relay 2
13.03 Discrete output 3	Relay 3
13.04 Discrete output 4	Relay 4
13.05 Discrete output 5	Relay 5
13.06 Discrete output 6	Relay 6
13.07 Discrete output 7	Relay 7
13.08 Discrete output 8	Relay 8
13.09 Discrete output 9	Relay 9
13.10 Discrete output 10	Relay 10
13.11 Discrete output 11	Relay 11
13.12 Discrete output 12	Relay 12
13.13 Discrete output 13	Relay 13
13.14 Discrete output 14	Relay 14
13.15 Discrete output 15	Relay 15
13.16 Discrete output 16	Relay 16
13.17 Discrete output 17	Relay 17
13.18 Discrete output 18	Relay 18
13.19 Discrete output 19	Relay 19

HMI Text	Note
13.20 Discrete output 20	Relay 20
13.21 Discrete output 21	Relay 21
13.22 Discrete output 22	Relay 22
13.33 Transistor output 1	Transistor output 1
13.34 Transistor output 2	Transistor output 1

9.3.2.14 Group 14 Engine control 2

HMI Text	Note
14.01 SCR low DEF level	"SCR low DEF level" (SPN 5245 Aftertreatment Selective Catalytic Reduction Operator Inducement Active)
14.02 SCR low DEF level!	"SCR low DEF level escalated" (SPN 5245 Aftertreatment Selective Catalytic Reduction Operator Inducement Active)
14.03 SCR Inducement level1	(14.03-14.08: SPN 5246 Aftertreatment SCR Operator Inducement Severity)
14.04 SCR Inducement level2	
14.05 SCR Inducement level3	
14.06 SCR Inducement level4	
14.07 SCR Inducement level5	
14.08 SCR Inducem. override	Temporary Override of Inducement
14.09 SCR Dormant	Dormant /sleep mode (14.09-14.18: SPN 4332 Aftertreatment 1 SCR System State)
14.10 SCR Prepare readiness	Preparing dosing readiness
14.11 SCR Normal dosing	Normal dosing operation
14.12 SCR System error	System error pending
14.13 SCR Protect heat	Protect mode against heat
14.14 SCR Protect cold	Protect mode against cold
14.15 SCR Shutoff	Shutoff (wait for afterrun)
14.16 SCR Diagnosis	Diagnosis (afterrun)
14.17 SCR Test Dos. allowed	Service test mode, dosing allowed
14.18 SCR Test D.not allow.	Service test mode, dosing not allowed
14.19 SCR Clean. lamp solid	(SPN 6915 SCR System Cleaning Lamp Command)
14.20 SCR Clean. lamp blink	(SPN 6915 SCR System Cleaning Lamp Command)
14.21 SCR Inhibit Switch	(SPN 6918 SCR System Cleaning Inhibited Due to Inhibit Switch)
14.22 After run active	(14.22 is for Scania S8 and FPT MD1) State of "Afterrun Status"
14.23 Low urea level	(14.23 to 14.35 are for Scania S8.) State of ID 15399 "Urea level inducement state": "Low urea level"
14.24 Fill up urea	State of ID 15399 "Urea level inducement state": "Fill up urea"
14.25 Urea tank empty	State of ID 15399 "Urea level inducement state": "Urea tank empty"
14.26 Dosing error	State of ID 15694 "Emission-OBd inducement failure reason": "Dosing error"

HMI Text	Note
14.27 Urea quality	State of ID 15694 "Emission-OBD inducement failure reason": "Urea quality"
14.28 Monitor failure	State of ID 15694 "Emission-OBD inducement failure reason": "Monitor failure"
14.29 NOx failure	State of ID 15694 "Emission-OBD inducement failure reason": "NOx failure"
14.30 HC Evap. required	State of ID 15695 "HC evaporation state": "Evaporation required - less urgent"
14.31 HC Evap. required!	State of ID 15695 "HC evaporation state": "Evaporation required - urgent"
14.32 HC Evap. in progress	State of ID 15695 "HC evaporation state": "Evaporation in progress"
14.33 HC run engine warm	State of ID 15696 "HC Evaporation Required Action": "HC run engine warm"
14.34 HC increased idle	State of ID 15696 "HC Evaporation Required Action": "Increased idle and heavy exhaust braking"
14.35 HC engine stop	State of ID 15696 "HC Evaporation Required Action": "HC engine stop"
14.36 Charger1: Idling	(SPN 4990 Battery Charger 1 State)
14.37 Charger1: Charging	(SPN 4990 Battery Charger 1 State)
14.38 Charger1: Stand-by	(SPN 4990 Battery Charger 1 State)
14.39 Charger1: Batt. fail.	(SPN 4990 Battery Charger 1 State)
14.40 Charger1: Charg.fail.	(SPN 4990 Battery Charger 1 State)
14.41 Charger1: Power conn.	(SPN 4991 Battery Charger 1 Power Line State: Connected)
14.42 O2 sensor used	(SPN 1696 Engine Exhaust O2 Sensor Closed Loop Operation)
14.43 Aftertr.1 Int. Dew P.	(SPN 3237 Aftertreatment 1 Intake Dew Point exceeded)
14.44 Aftertr.1 Exh. Dew P.	(SPN SPN 3238 Aftertreatment 1 Exhaust Dew Point exceeded)
14.45 Aftertr.2 Int. Dew P.	(SPN SPN 3239 Aftertreatment 2 Intake Dew Point exceeded)
14.46 Aftertr.2 Exh. Dew P.	(SPN 3240 Aftertreatment 1 Exhaust Dew Point exceeded)
14.47 Water in fuel	(SPN 97 Water in fuel)
14.48 T Coolant: Prewarning	(FPT1 MD1 Coolant temperature: Prewarning)
14.49 T Coolant: Warning	(FPT1 MD 1 Coolant temperature: Warning)
14.50 Low oil pressure	(FPT1 MD 1 Low engine oil pressure)
14.51 Fuel filter: Clogged	(FPT1 MD Clogging fuel filter: clogged)
14.52 Fuel prefilt.:Clogged	(FPT1 MD Clogging fuel pre filter: clogged)
14.53 Tamp. ind.: Warning	(FPT1 MD System tampering inducement: Warning)
14.54 Tamp. ind.: Moderate	(FPT1 MD System tampering inducement: Moderate)
14.55 Tamp. ind.: Severe	(FPT1 MD System tampering inducement: Severe)
14.56 DEF level: Warning	(FPT1 MD DEF level inducement: warning)
14.57 DEF level: Moderate	(FPT1 MD DEF level inducement: Moderate)
14.58 DEF level: Severe	(FPT1 MD DEF level inducement: Severe)
14.59 DEF quality: Warning	(FPT1 MD DEF quality inducement: warning)
14.60 DEF quality: Moderate	(FPT1 MD DEF quality inducement: Moderate)
14.61 DEF quality: Severe	(FPT1 MD DEFquality inducement: Severe)

9.3.2.15 Group 15: Flexible limits

TRUE if the alarm is active or latched.

HMI Text	Note
15.01 Flexible limit 1	
15.02 Flexible limit 2	
15.03 Flexible limit 3	
15.04 Flexible limit 4	
15.05 Flexible limit 5	
15.06 Flexible limit 6	
15.07 Flexible limit 7	
15.08 Flexible limit 8	
15.09 Flexible limit 9	
15.10 Flexible limit 10	
15.11 Flexible limit 11	
15.12 Flexible limit 12	
15.13 Flexible limit 13	
15.14 Flexible limit 14	
15.15 Flexible limit 15	
15.16 Flexible limit 16	
15.17 Flexible limit 17	
15.18 Flexible limit 18	
15.19 Flexible limit 19	
15.20 Flexible limit 20	
15.21 Flexible limit 21	
15.22 Flexible limit 22	
15.23 Flexible limit 23	
15.24 Flexible limit 24	
15.25 Flexible limit 25	
15.26 Flexible limit 26	
15.27 Flexible limit 27	
15.28 Flexible limit 28	
15.29 Flexible limit 29	
15.30 Flexible limit 30	
15.31 Flexible limit 31	
15.32 Flexible limit 32	
15.33 Flexible limit 33	
15.34 Flexible limit 34	
15.35 Flexible limit 35	

HMI Text	Note
15.36 Flexible limit 36	
15.37 Flexible limit 37	
15.38 Flexible limit 38	
15.39 Flexible limit 39	
15.40 Flexible limit 40	

9.3.2.16 Group 16: Free alarms latched

TRUE if the alarm is active or latched.

HMI Text	Note
16.01 Free alarm 1 latched	
16.02 Free alarm 2 latched	
16.03 Free alarm 3 latched	
16.04 Free alarm 4 latched	
16.05 Free alarm 5 latched	
16.06 Free alarm 6 latched	
16.07 Free alarm 7 latched	
16.08 Free alarm 8 latched	
16.09 Free alarm 9 latched	
16.10 Free alarm 10 latched	
16.11 Free alarm 11 latched	
16.12 Free alarm 12 latched	
16.13 Free alarm 13 latched	
16.14 Free alarm 14 latched	
16.15 Free alarm 15 latched	
16.16 Free alarm 16 latched	
16.17 Free alarm 17 latched	
16.18 Free alarm 18 latched	
16.19 Free alarm 19 latched	
16.20 Free alarm 20 latched	
16.21 Free alarm 21 latched	
16.22 Free alarm 22 latched	
16.23 Free alarm 23 latched	
16.24 Free alarm 24 latched	
16.25 Free alarm 25 latched	
16.26 Free alarm 26 latched	
16.27 Free alarm 27 latched	
16.28 Free alarm 28 latched	

HMI Text	Note
16.29 Free alarm 29 latched	
16.30 Free alarm 30 latched	
16.31 Free alarm 31 latched	
16.32 Free alarm 32 latched	

9.3.2.17 Group 17: System alarms

TRUE if the alarm is active or latched.

HMI Text	Note
17.01 Act. load shar.mism.	Monitor Active load share mismatch
17.02 React.load shar.mism	Monitor Reactive load share mismatch
17.05 Missing member 4105	Missing member 4105
17.06 Para.alignment 4105	Parameter alignment VDE 4105
17.07 Meas.difference 4105	Meas.difference VDE 4105
17.08 Decoupling GCB<->MCB	Tripping according to parameter 3110.
17.09 N-cont. reply mism.	Neutral interlocking reply mismatch

9.3.2.18 Group 18: Buttons

TRUE if the button is pressed. For front panel view refer to  Fig. 4 .

HMI Text	Note
18.01 Button 1	Softkey
18.02 Button 2	Softkey
18.03 Button 3	Softkey
18.04 Button Home	Back to Home Screen
18.05 Button 5	Softkey
18.06 Button 6	Softkey
18.07 Button 7	Softkey
18.08 Button 8	Softkey
18.09 Button 9	Softkey
18.10 Button 10	Softkey
18.11 Button 11	Softkey
18.12 Button MAN	Manual mode
18.13 Button AUTO	Auto mode
18.14 Button MAN start	Start prime mover in Manual Mode
18.15 Button MAN stop	Stop prime mover in Manual Mode
18.16 Button TEST	Test mode
18.17 Button STOP	Stop mode

HMI Text	Note
18.18 Button Acknow.	Acknowledge
18.19 EL200 Button Ack. 1	easYlite-200 (1) acknowledge button
18.20 EL200 Button Ack. 2	easYlite-200 (2) acknowledge button

9.3.2.19 Group 22: GC alarm flags

These alarms were transmitted from the Group Controller (GC) to the easYgen. They are not in the alarm system of the easYgen.

But they could be used in LogicsManagers e.g. to generate Free Alarms.

HMI Text	Note
22.01 GC NW CAN 1 error	TRUE if the GC sees no taught in easYgen at all on CAN 1 is recognized.
22.02 GC NW EthA error	TRUE if the GC sees no taught in easYgen at all on Ethernet A is recognized.
22.03 GC NW EthB error	TRUE if no other taught in GC on Ethernet B is recognized.
22.04 GC NW EthC error	TRUE if no other taught in GC on Ethernet C is recognized.
22.05 GC CAN1 EthA redund.	TRUE if there is no easYgen recognized either at CAN1 or Ethernet A . (Only in redundant mode.)
22.06 GC EthB EthC redund.	TRUE if there is no GC recognized either at Ethernet B or Ethernet C. (Only in redundant mode.)
22.07 GC Syst. upd. Layer 1	TRUE if a GC System update Layer 1 (easYgen) is required.
22.08 GC Syst. upd. Layer 3	TRUE if a GC System update Layer 3 (GC) is required.
22.09 GC Missing easYgen	TRUE if a taught in easYgen is missing
22.10 GC Missing GC	TRUE if a taught in GC is missing
22.11 GC Group not ok	TRUE if at least one of these failures becomes active: easYgen is missing OR CAN1 EthA redundancy lost
22.17 GC GGB fail to close	TRUE if the GC has attempted to close the GGB for the configured maximum number of attempts and failed.
22.18 GC GGB fail to open	TRUE if the GC is still receiving the reply "GGB closed" after the GGB open monitoring timer has expired.
22.19 GC Gen.gr.ph.rot.mism	TRUE if the measured phase rotation of the generator group does not match the configured one.
22.20 GC Mains ph.rot.mism.	TRUE if the measured phase rotation of the mains does not match the configured one.
22.21 GC Ph. rot. mismatch	TRUE if different phase rotation of mains and the generator group are detected.
22.22 GC GGB feedback check	TRUE if the GGB reply indicates a closed GGB, but the phase angle between the load busbar and the Generator Group is outside the 12° -window.

HMI Text	Note
22.23 GC Gen. AC wiring	TRUE if one or more of the generator voltages are wrongly wired (detected by the plausibility checking of frequencies).
22.24 GC Busbar 1 AC wiring	TRUE if one or more of the bus bar voltages are wrongly wired (detected by the plausibility checking of frequencies).
22.25 GC Mains AC wiring	TRUE if one or more of the mains voltages are wrongly wired (detected by the plausibility checking of frequencies).
22.26 GC MCB fail to close	TRUE if the GC has attempted to close the MCB for the configured maximum number of attempts and failed.
22.27 GC MCB fail to open	TRUE if the GC is still receiving the reply "MCB closed" after the MCB open monitoring timer has expired.
22.28 GC Wb:Analog input 1	TRUE if there is a wire break according to the AI 1 configuration (in GC) detected.
22.29 GC Wb:Analog input 2	TRUE if there is a wire break according to the AI 2 configuration (in GC) detected.
22.30 GC Paramet. alignment	TRUE if GCs have different LDSS settings
22.31 GC Wb:Analog input 3	TRUE if there is a wire break according to the AI 3 configuration (in GC) detected.
22.32 GC Missing LSx Layer3	At least one LSx Layer 3 (GC) is missing.
22.33 GC common alarm	TRUE if there is at least one active or latched alarm in the GC. (As exception this flag is available in the alarm system of the easYgen with alarm class A.) An acknowledgement of this alarm in the easYgen causes an acknowledgement of all not active alarm in the GC. The common alarm itself can only be acknowledged if there is no active alarm anymore in GC.
22.34 GC Missing LSx Layer1	At least one LSx Layer 1 (GC) is missing.
22.35 GC CANopen Interf. 1	CANopen error interface 1 (GC)
22.36 GC CANopen Interf. 2	CANopen error interface 2 (GC)
22.37 GC Ethernet issue	Ethernet issue (GC) (E.g. broadcast storm)

9.3.2.20 Group 25: External analog inputs out of range

TRUE, if "out of range" or "wire break" of the external analog input is detected. (Only if this function is supported by the external device.)

HMI Text	Note
25.01 Ext AI 1 wire break	
25.02 Ext AI 2 wire break	
25.03 Ext AI 3 wire break	
25.04 Ext AI 4 wire break	
25.05 Ext AI 5 wire break	
25.06 Ext AI 6 wire break	

HMI Text	Note
25.07 Ext AI 7 wire break	
25.08 Ext AI 8 wire break	
25.09 Ext AI 9 wire break	
25.10 Ext AI 10 wire break	
25.11 Ext AI 11 wire break	
25.12 Ext AI 12 wire break	
25.13 Ext AI 13 wire break	
25.14 Ext AI 14 wire break	
25.15 Ext AI 15 wire break	
25.16 Ext AI 16 wire break	

9.3.2.21 Group 26: Flags from LSx 33-48 (Layer 1)

TRUE if the flag in the corresponding LSx device is set.

HMI Text	Note
26.01 Flag 1 LSx device 33	
26.02 Flag 2 LSx device 33	
26.03 Flag 3 LSx device 33	
26.04 Flag 4 LSx device 33	
26.05 Flag 5 LSx device 33	
26.06 Flag 1 LSx device 34	
26.07 Flag 2 LSx device 34	
26.08 Flag 3 LSx device 34	
26.09 Flag 4 LSx device 34	
26.10 Flag 5 LSx device 34	
26.11 Flag 1 LSx device 35	
26.12 Flag 2 LSx device 35	
26.13 Flag 3 LSx device 35	
26.14 Flag 4 LSx device 35	
26.15 Flag 5 LSx device 35	
26.16 Flag 1 LSx device 36	
26.17 Flag 2 LSx device 36	
26.18 Flag 3 LSx device 36	
26.19 Flag 4 LSx device 36	
26.20 Flag 5 LSx device 36	
26.21 Flag 1 LSx device 37	
26.22 Flag 2 LSx device 37	
26.23 Flag 3 LSx device 37	

HMI Text	Note
26.24 Flag 4 LSx device 37	
26.25 Flag 5 LSx device 37	
26.26 Flag 1 LSx device 38	
26.27 Flag 2 LSx device 38	
26.28 Flag 3 LSx device 38	
26.29 Flag 4 LSx device 38	
26.30 Flag 5 LSx device 38	
26.31 Flag 1 LSx device 39	
26.32 Flag 2 LSx device 39	
26.33 Flag 3 LSx device 39	
26.34 Flag 4 LSx device 39	
26.35 Flag 5 LSx device 39	
26.36 Flag 1 LSx device 40	
26.37 Flag 2 LSx device 40	
26.38 Flag 3 LSx device 40	
26.39 Flag 4 LSx device 40	
26.40 Flag 5 LSx device 40	
26.41 Flag 1 LSx device 41	
26.42 Flag 2 LSx device 41	
26.43 Flag 3 LSx device 41	
26.44 Flag 4 LSx device 41	
26.45 Flag 5 LSx device 41	
26.46 Flag 1 LSx device 42	
26.47 Flag 2 LSx device 42	
26.48 Flag 3 LSx device 42	
26.49 Flag 4 LSx device 42	
26.50 Flag 5 LSx device 42	
26.51 Flag 1 LSx device 43	
26.52 Flag 2 LSx device 43	
26.53 Flag 3 LSx device 43	
26.54 Flag 4 LSx device 43	
26.55 Flag 5 LSx device 43	
26.56 Flag 1 LSx device 44	
26.57 Flag 2 LSx device 44	
26.58 Flag 3 LSx device 44	
26.59 Flag 4 LSx device 44	
26.60 Flag 5 LSx device 44	
26.61 Flag 1 LSx device 45	

HMI Text	Note
26.62 Flag 2 LSx device 45	
26.63 Flag 3 LSx device 45	
26.64 Flag 4 LSx device 45	
26.65 Flag 5 LSx device 45	
26.66 Flag 1 LSx device 46	
26.67 Flag 2 LSx device 46	
26.68 Flag 3 LSx device 46	
26.69 Flag 4 LSx device 46	
26.70 Flag 5 LSx device 46	
26.71 Flag 1 LSx device 47	
26.72 Flag 2 LSx device 47	
26.73 Flag 3 LSx device 47	
26.74 Flag 4 LSx device 47	
26.75 Flag 5 LSx device 47	
26.76 Flag 1 LSx device 48	
26.77 Flag 2 LSx device 48	
26.78 Flag 3 LSx device 48	
26.79 Flag 4 LSx device 48	
26.80 Flag 5 LSx device 48	

9.3.2.22 Group 27: Flags from LSx 49-64 (Layer 1)

TRUE if the flag in the corresponding LSx device is set.

HMI Text	Note
27.01 Flag 1 LSx device 49	
27.02 Flag 2 LSx device 49	
27.03 Flag 3 LSx device 49	
27.04 Flag 4 LSx device 49	
27.05 Flag 5 LSx device 49	
27.06 Flag 1 LSx device 50	
27.07 Flag 2 LSx device 50	
27.08 Flag 3 LSx device 50	
27.09 Flag 4 LSx device 50	
27.10 Flag 5 LSx device 50	
27.11 Flag 1 LSx device 51	
27.12 Flag 2 LSx device 51	
27.13 Flag 3 LSx device 51	
27.14 Flag 4 LSx device 51	

HMI Text	Note
27.15 Flag 5 LSx device 51	
27.16 Flag 1 LSx device 52	
27.17 Flag 2 LSx device 52	
27.18 Flag 3 LSx device 52	
27.19 Flag 4 LSx device 52	
27.20 Flag 5 LSx device 52	
27.21 Flag 1 LSx device 53	
27.22 Flag 2 LSx device 53	
27.23 Flag 3 LSx device 53	
27.24 Flag 4 LSx device 53	
27.25 Flag 5 LSx device 53	
27.26 Flag 1 LSx device 54	
27.27 Flag 2 LSx device 54	
27.28 Flag 3 LSx device 54	
27.29 Flag 4 LSx device 54	
27.30 Flag 5 LSx device 54	
27.31 Flag 1 LSx device 55	
27.32 Flag 2 LSx device 55	
27.33 Flag 3 LSx device 55	
27.34 Flag 4 LSx device 55	
27.35 Flag 5 LSx device 55	
27.36 Flag 1 LSx device 56	
27.37 Flag 2 LSx device 56	
27.38 Flag 3 LSx device 56	
27.39 Flag 4 LSx device 56	
27.40 Flag 5 LSx device 56	
27.41 Flag 1 LSx device 57	
27.42 Flag 2 LSx device 57	
27.43 Flag 3 LSx device 57	
27.44 Flag 4 LSx device 57	
27.45 Flag 5 LSx device 57	
27.46 Flag 1 LSx device 58	
27.47 Flag 2 LSx device 58	
27.48 Flag 3 LSx device 58	
27.49 Flag 4 LSx device 58	
27.50 Flag 5 LSx device 58	
27.51 Flag 1 LSx device 59	
27.52 Flag 2 LSx device 59	

HMI Text	Note
27.53 Flag 3 LSx device 59	
27.54 Flag 4 LSx device 59	
27.55 Flag 5 LSx device 59	
27.56 Flag 1 LSx device 60	
27.57 Flag 2 LSx device 60	
27.58 Flag 3 LSx device 60	
27.59 Flag 4 LSx device 60	
27.60 Flag 5 LSx device 60	
27.61 Flag 1 LSx device 61	
27.62 Flag 2 LSx device 61	
27.63 Flag 3 LSx device 61	
27.64 Flag 4 LSx device 61	
27.65 Flag 5 LSx device 61	
27.66 Flag 1 LSx device 62	
27.67 Flag 2 LSx device 62	
27.68 Flag 3 LSx device 62	
27.69 Flag 4 LSx device 62	
27.70 Flag 5 LSx device 62	
27.71 Flag 1 LSx device 63	
27.72 Flag 2 LSx device 63	
27.73 Flag 3 LSx device 63	
27.74 Flag 4 LSx device 63	
27.75 Flag 5 LSx device 63	
27.76 Flag 1 LSx device 64	
27.77 Flag 2 LSx device 64	
27.78 Flag 3 LSx device 64	
27.79 Flag 4 LSx device 64	
27.80 Flag 5 LSx device 64	

9.3.2.23 Group 28: LSx System conditions (Layer 1)

TRUE if at least one easYgen sets the command variable to TRUE (OR operation)

HMI Text	Note
28.01 Command 1 to LSx(OR)	
28.02 Command 2 to LSx(OR)	
28.03 Command 3 to LSx(OR)	
28.04 Command 4 to LSx(OR)	
28.05 Command 5 to LSx(OR)	

HMI Text	Note
28.06 Command 6 to LSx(OR)	

9.3.2.24 Group 31: Pulse signals

Refer to chapter "Counter Pulses and Transistor Output"

HMI Text	Note
31.01 Pulse signal A	kWh / kvarh counter
31.02 Pulse signal B	kWh / kvarh counter

9.3.2.25 Group 32: CAN1 Receive PDO1

Bits of CAN RPDO1 WORD 1 (ID 3371)

HMI Text	Note
32.01 CAN1 RPDO1.1.1	CAN1 RPDO1 Word1 Bit1
32.02 CAN1 RPDO1.1.2	CAN1 RPDO1 Word1 Bit2
32.03 CAN1 RPDO1.1.3	CAN1 RPDO1 Word1 Bit3
32.04 CAN1 RPDO1.1.4	CAN1 RPDO1 Word1 Bit4
32.05 CAN1 RPDO1.1.5	CAN1 RPDO1 Word1 Bit5
32.06 CAN1 RPDO1.1.6	CAN1 RPDO1 Word1 Bit6
32.07 CAN1 RPDO1.1.7	CAN1 RPDO1 Word1 Bit7
32.08 CAN1 RPDO1.1.8	CAN1 RPDO1 Word1 Bit8
32.09 CAN1 RPDO1.1.9	CAN1 RPDO1 Word1 Bit9
32.10 CAN1 RPDO1.1.10	CAN1 RPDO1 Word1 Bit10
32.11 CAN1 RPDO1.1.11	CAN1 RPDO1 Word1 Bit11
32.12 CAN1 RPDO1.1.12	CAN1 RPDO1 Word1 Bit12
32.13 CAN1 RPDO1.1.13	CAN1 RPDO1 Word1 Bit13
32.14 CAN1 RPDO1.1.14	CAN1 RPDO1 Word1 Bit14
32.15 CAN1 RPDO1.1.15	CAN1 RPDO1 Word1 Bit15
32.16 CAN1 RPDO1.1.16	CAN1 RPDO1 Word1 Bit16

9.3.2.26 Group 33: CAN1 Receive PDO2

Bits of CAN RPDO2 WORD 1 (ID 3375)

HMI Text	Note
33.01 CAN1 RPDO2.1.1	CAN1 RPDO2 Word1 Bit1
33.02 CAN1 RPDO2.1.2	CAN1 RPDO2 Word1 Bit2
33.03 CAN1 RPDO2.1.3	CAN1 RPDO2 Word1 Bit3
33.04 CAN1 RPDO2.1.4	CAN1 RPDO2 Word1 Bit4

HMI Text	Note
33.05 CAN1 RPDO2.1.5	CAN1 RPDO2 Word1 Bit5
33.06 CAN1 RPDO2.1.6	CAN1 RPDO2 Word1 Bit6
33.07 CAN1 RPDO2.1.7	CAN1 RPDO2 Word1 Bit7
33.08 CAN1 RPDO2.1.8	CAN1 RPDO2 Word1 Bit8
33.09 CAN1 RPDO2.1.9	CAN1 RPDO2 Word1 Bit9
33.10 CAN1 RPDO2.1.10	CAN1 RPDO2 Word1 Bit10
33.11 CAN1 RPDO2.1.11	CAN1 RPDO2 Word1 Bit11
33.12 CAN1 RPDO2.1.12	CAN1 RPDO2 Word1 Bit12
33.13 CAN1 RPDO2.1.13	CAN1 RPDO2 Word1 Bit13
33.14 CAN1 RPDO2.1.14	CAN1 RPDO2 Word1 Bit14
33.15 CAN1 RPDO2.1.15	CAN1 RPDO2 Word1 Bit15
33.16 CAN1 RPDO2.1.16	CAN1 RPDO2 Word1 Bit16

9.3.2.27 Group 34: CAN1 Receive PDO3

Bits of CAN RPDO3 WORD 1 (ID 3379)

HMI Text	Note
34.01 CAN1 RPDO3.1.1	CAN1 RPDO3 Word1 Bit1
34.02 CAN1 RPDO3.1.2	CAN1 RPDO3 Word1 Bit2
34.03 CAN1 RPDO3.1.3	CAN1 RPDO3 Word1 Bit3
34.04 CAN1 RPDO3.1.4	CAN1 RPDO3 Word1 Bit4
34.05 CAN1 RPDO3.1.5	CAN1 RPDO3 Word1 Bit5
34.06 CAN1 RPDO3.1.6	CAN1 RPDO3 Word1 Bit6
34.07 CAN1 RPDO3.1.7	CAN1 RPDO3 Word1 Bit7
34.08 CAN1 RPDO3.1.8	CAN1 RPDO3 Word1 Bit8
34.09 CAN1 RPDO3.1.9	CAN1 RPDO3 Word1 Bit9
34.10 CAN1 RPDO3.1.10	CAN1 RPDO3 Word1 Bit10
34.11 CAN1 RPDO3.1.11	CAN1 RPDO3 Word1 Bit11
34.12 CAN1 RPDO3.1.12	CAN1 RPDO3 Word1 Bit12
34.13 CAN1 RPDO3.1.13	CAN1 RPDO3 Word1 Bit13
34.14 CAN1 RPDO3.1.14	CAN1 RPDO3 Word1 Bit14
34.15 CAN1 RPDO3.1.15	CAN1 RPDO3 Word1 Bit15
34.16 CAN1 RPDO3.1.16	CAN1 RPDO3 Word1 Bit16

9.3.2.28 Group 35: CAN1 Receive PDO4

Bits of CAN RPDO4 WORD 1 (ID 3383)

HMI Text	Note
35.01 CAN1 RPDO4.1.1	CAN1 RPDO4 Word1 Bit1
35.02 CAN1 RPDO4.1.2	CAN1 RPDO4 Word1 Bit2
35.03 CAN1 RPDO4.1.3	CAN1 RPDO4 Word1 Bit3
35.04 CAN1 RPDO4.1.4	CAN1 RPDO4 Word1 Bit4
35.05 CAN1 RPDO4.1.5	CAN1 RPDO4 Word1 Bit5
35.06 CAN1 RPDO4.1.6	CAN1 RPDO4 Word1 Bit6
35.07 CAN1 RPDO4.1.7	CAN1 RPDO4 Word1 Bit7
35.08 CAN1 RPDO4.1.8	CAN1 RPDO4 Word1 Bit8
35.09 CAN1 RPDO4.1.9	CAN1 RPDO4 Word1 Bit9
35.10 CAN1 RPDO4.1.10	CAN1 RPDO4 Word1 Bit10
35.11 CAN1 RPDO4.1.11	CAN1 RPDO4 Word1 Bit11
35.12 CAN1 RPDO4.1.12	CAN1 RPDO4 Word1 Bit12
35.13 CAN1 RPDO4.1.13	CAN1 RPDO4 Word1 Bit13
35.14 CAN1 RPDO4.1.14	CAN1 RPDO4 Word1 Bit14
35.15 CAN1 RPDO4.1.15	CAN1 RPDO4 Word1 Bit15
35.16 CAN1 RPDO4.1.16	CAN1 RPDO4 Word1 Bit16

9.3.2.29 Group 36: CAN1 Receive PDO5

Bits of CAN RPDO5 WORD 1 (ID 3387)

HMI Text	Note
36.01 CAN1 RPDO5.1.1	CAN1 RPDO5 Word1 Bit1
36.02 CAN1 RPDO5.1.2	CAN1 RPDO5 Word1 Bit2
36.03 CAN1 RPDO5.1.3	CAN1 RPDO5 Word1 Bit3
36.04 CAN1 RPDO5.1.4	CAN1 RPDO5 Word1 Bit4
36.05 CAN1 RPDO5.1.5	CAN1 RPDO5 Word1 Bit5
36.06 CAN1 RPDO5.1.6	CAN1 RPDO5 Word1 Bit6
36.07 CAN1 RPDO5.1.7	CAN1 RPDO5 Word1 Bit7
36.08 CAN1 RPDO5.1.8	CAN1 RPDO5 Word1 Bit8
36.09 CAN1 RPDO5.1.9	CAN1 RPDO5 Word1 Bit9
36.10 CAN1 RPDO5.1.10	CAN1 RPDO5 Word1 Bit10
36.11 CAN1 RPDO5.1.11	CAN1 RPDO5 Word1 Bit11
36.12 CAN1 RPDO5.1.12	CAN1 RPDO5 Word1 Bit12
36.13 CAN1 RPDO5.1.13	CAN1 RPDO5 Word1 Bit13
36.14 CAN1 RPDO5.1.14	CAN1 RPDO5 Word1 Bit14
36.15 CAN1 RPDO5.1.15	CAN1 RPDO5 Word1 Bit15

HMI Text	Note
36.16 CAN1 RPDO5.1.16	CAN1 RPDO5 Word1 Bit16

9.3.2.30 Group 54: Modbus Master flags

TRUE if the flag is active

HMI Text	Note
54.01 Mapped LM flag 1	Modbus Master mapped flag 1
54.02 Mapped LM flag 2	Modbus Master mapped flag 2
54.03 Mapped LM flag 3	Modbus Master mapped flag 3
54.04 Mapped LM flag 4	Modbus Master mapped flag 4
54.05 Mapped LM flag 5	Modbus Master mapped flag 5
54.06 Mapped LM flag 6	Modbus Master mapped flag 6
54.07 Mapped LM flag 7	Modbus Master mapped flag 7
54.08 Mapped LM flag 8	Modbus Master mapped flag 8
54.09 Mapped LM flag 9	Modbus Master mapped flag 9
54.10 Mapped LM flag 10	Modbus Master mapped flag 10
54.11 Mapped LM flag 11	Modbus Master mapped flag 11
54.12 Mapped LM flag 12	Modbus Master mapped flag 12
54.13 Mapped LM flag 13	Modbus Master mapped flag 13
54.14 Mapped LM flag 14	Modbus Master mapped flag 14
54.15 Mapped LM flag 15	Modbus Master mapped flag 15
54.16 Mapped LM flag 16	Modbus Master mapped flag 16
54.17 Mapped LM flag 17	Modbus Master mapped flag 17
54.18 Mapped LM flag 18	Modbus Master mapped flag 18
54.19 Mapped LM flag 19	Modbus Master mapped flag 19
54.20 Mapped LM flag 20	Modbus Master mapped flag 20
54.21 Mapped LM flag 21	Modbus Master mapped flag 21
54.22 Mapped LM flag 22	Modbus Master mapped flag 22
54.23 Mapped LM flag 23	Modbus Master mapped flag 23
54.24 Mapped LM flag 24	Modbus Master mapped flag 24
54.25 Mapped LM flag 25	Modbus Master mapped flag 25
54.26 Mapped LM flag 26	Modbus Master mapped flag 26
54.27 Mapped LM flag 27	Modbus Master mapped flag 27
54.28 Mapped LM flag 28	Modbus Master mapped flag 28
54.29 Mapped LM flag 29	Modbus Master mapped flag 29
54.30 Mapped LM flag 30	Modbus Master mapped flag 30
54.31 Mapped LM flag 31	Modbus Master mapped flag 31
54.32 Mapped LM flag 32	Modbus Master mapped flag 32

HMI Text	Note
54.33 Mapped LM flag 33	Modbus Master mapped flag 33
54.34 Mapped LM flag 34	Modbus Master mapped flag 34
54.35 Mapped LM flag 35	Modbus Master mapped flag 35
54.36 Mapped LM flag 36	Modbus Master mapped flag 36
54.37 Mapped LM flag 37	Modbus Master mapped flag 37
54.38 Mapped LM flag 38	Modbus Master mapped flag 38
54.39 Mapped LM flag 39	Modbus Master mapped flag 39
54.40 Mapped LM flag 40	Modbus Master mapped flag 40
54.41 Mapped LM flag 41	Modbus Master mapped flag 41
54.42 Mapped LM flag 42	Modbus Master mapped flag 42
54.43 Mapped LM flag 43	Modbus Master mapped flag 43
54.44 Mapped LM flag 44	Modbus Master mapped flag 44
54.45 Mapped LM flag 45	Modbus Master mapped flag 45
54.46 Mapped LM flag 46	Modbus Master mapped flag 46
54.47 Mapped LM flag 47	Modbus Master mapped flag 47
54.48 Mapped LM flag 48	Modbus Master mapped flag 48
54.49 Mapped LM flag 49	Modbus Master mapped flag 49
54.50 Mapped LM flag 50	Modbus Master mapped flag 50
54.51 Mapped LM flag 51	Modbus Master mapped flag 51
54.52 Mapped LM flag 52	Modbus Master mapped flag 52
54.53 Mapped LM flag 53	Modbus Master mapped flag 53
54.54 Mapped LM flag 54	Modbus Master mapped flag 54
54.55 Mapped LM flag 55	Modbus Master mapped flag 55
54.56 Mapped LM flag 56	Modbus Master mapped flag 56
54.57 Mapped LM flag 57	Modbus Master mapped flag 57
54.58 Mapped LM flag 58	Modbus Master mapped flag 58
54.59 Mapped LM flag 59	Modbus Master mapped flag 59
54.60 Mapped LM flag 60	Modbus Master mapped flag 60
54.61 Mapped LM flag 61	Modbus Master mapped flag 61
54.62 Mapped LM flag 62	Modbus Master mapped flag 62
54.63 Mapped LM flag 63	Modbus Master mapped flag 63
54.64 Mapped LM flag 64	Modbus Master mapped flag 64
54.65 Mapped LM flag 65	Modbus Master mapped flag 65
54.66 Mapped LM flag 66	Modbus Master mapped flag 66
54.67 Mapped LM flag 67	Modbus Master mapped flag 67
54.68 Mapped LM flag 68	Modbus Master mapped flag 68
54.69 Mapped LM flag 69	Modbus Master mapped flag 69
54.70 Mapped LM flag 70	Modbus Master mapped flag 70

HMI Text	Note
54.71 Mapped LM flag 71	Modbus Master mapped flag 71
54.72 Mapped LM flag 72	Modbus Master mapped flag 72
54.73 Mapped LM flag 73	Modbus Master mapped flag 73
54.74 Mapped LM flag 74	Modbus Master mapped flag 74
54.75 Mapped LM flag 75	Modbus Master mapped flag 75
54.76 Mapped LM flag 76	Modbus Master mapped flag 76
54.77 Mapped LM flag 77	Modbus Master mapped flag 77
54.78 Mapped LM flag 78	Modbus Master mapped flag 78
54.79 Mapped LM flag 79	Modbus Master mapped flag 79
54.80 Mapped LM flag 80	Modbus Master mapped flag 80
54.81 Mapped LM flag 81	Modbus Master mapped flag 81
54.82 Mapped LM flag 82	Modbus Master mapped flag 82
54.83 Mapped LM flag 83	Modbus Master mapped flag 83
54.84 Mapped LM flag 84	Modbus Master mapped flag 84
54.85 Mapped LM flag 85	Modbus Master mapped flag 85
54.86 Mapped LM flag 86	Modbus Master mapped flag 86
54.87 Mapped LM flag 87	Modbus Master mapped flag 87
54.88 Mapped LM flag 88	Modbus Master mapped flag 88
54.89 Mapped LM flag 89	Modbus Master mapped flag 89
54.90 Mapped LM flag 90	Modbus Master mapped flag 90
54.91 Mapped LM flag 91	Modbus Master mapped flag 91
54.92 Mapped LM flag 92	Modbus Master mapped flag 92
54.93 Mapped LM flag 93	Modbus Master mapped flag 93
54.94 Mapped LM flag 94	Modbus Master mapped flag 94
54.95 Mapped LM flag 95	Modbus Master mapped flag 95
54.96 Mapped LM flag 96	Modbus Master mapped flag 96
54.97 Mapped LM flag 97	Modbus Master mapped flag 97
54.98 Mapped LM flag 98	Modbus Master mapped flag 98
54.99 Mapped LM flag 99	Modbus Master mapped flag 99

9.3.2.31 Group 81: AnalogManager boolean results 1

TRUE if the boolean result of the corresponding AnalogManager equation is true.

HMI Text	Note
81.01 AM Preglow criterion	AM Preglow criterion
81.02 AM Warm-up criterion	AM Engine Warm-up criterion
81.03 AM Frequency SP1[Hz]	AM Frequency setpoint 1 source
81.04 AM Frequency SP2[Hz]	AM Frequency setpoint 2 source

HMI Text	Note
81.05 AM ActPower SP1 [kW]	AM Active power setpoint 1 source
81.06 AM ActPower SP2 [kW]	AM Active power setpoint 2 source
81.07 AM ActPower SP3 [kW]	AM Active power setpoint 3 source
81.08 AM ActPower SP4 [kW]	AM Active power setpoint 4 source
81.09 AM Voltage SP1 [V]	AM Voltage setpoint 1 source
81.10 AM Voltage SP2 [V]	AM Voltage setpoint 2 source
81.11 AM PF/var SP1[-/kvar]	AM Reactive power setpoint 1 source
81.12 AM PF/var SP2[-/kvar]	AM Reactive power setpoint 2 source
81.13 AM PID1 setpoint	AM PID 1 control setpoint
81.14 AM PID1 actual value	AM PID 1 control actual value
81.15 AM PID2 setpoint	AM PID 2 control setpoint
81.16 AM PID2 actual value	AM PID 2 control actual value
81.17 AM PID3 setpoint	AM PID 3 control setpoint
81.18 AM PID3 actual value	AM PID 3 control actual value
81.19 AM Ext.mains act.pwr.	AM External measured mains active power
81.20 AM Ext.mains RPower	AM External measured mains reactive power
81.21 AM Derating source	AM Free derating source
81.22 AM ECU seq.A_IN_1	AM ECU sequencer analog input 1
81.23 AM ECU seq.A_IN_2	AM ECU sequencer analog input 2
81.24 AM Engine speed	AM Engine speed
81.25 AM Engine oil press.	AM Engine oil pressure
81.26 AM Engine hours	AM Engine hours
81.27 AM Engine fuel level	AM Engine fuel level
81.28 AM Engine batt.volt.	AM Engine battery voltage
81.29 AM Engine coolant T	AM Engine coolant water temperature
81.30 AM Consumer load [kW]	AM Consumer load [kW]
81.31 AM Reference VQ0	AM Reference VQ0
81.32 AM Q/P ref.offset	AM Q/P reference offset
81.35 AM SP PID-source [%]	Voltage setpoint PID source for J1939 AVR
81.36 AM Source exc.SP [%]	Source excitation setpoint AVR bridge
81.37 AM PV rated pwr [kW]	PV rated active power
81.38 AM PV actual pwr [kW]	PV actual active power
81.39 AM Gen. group1 [kW]	Generator group 1 actual active power
81.40 AM Gen. group2 [kW]	Generator group 2 actual active power
81.41 AM Gen.min power [kW]	Generator minimum active power

9.3.2.32 Group 82: AnalogManager boolean results 2 (Flexible Limits)

TRUE if the boolean result of the corresponding AnalogManager equation is true.

HMI Text	Note
82.01 AM Flexible limit 1	AM Monitored flexible limit 1
82.02 AM Flexible limit 2	AM Monitored flexible limit 2
82.03 AM Flexible limit 3	AM Monitored flexible limit 3
82.04 AM Flexible limit 4	AM Monitored flexible limit 4
82.05 AM Flexible limit 5	AM Monitored flexible limit 5
82.06 AM Flexible limit 6	AM Monitored flexible limit 6
82.07 AM Flexible limit 7	AM Monitored flexible limit 7
82.08 AM Flexible limit 8	AM Monitored flexible limit 8
82.09 AM Flexible limit 9	AM Monitored flexible limit 9
82.10 AM Flexible limit 10	AM Monitored flexible limit 10
82.11 AM Flexible limit 11	AM Monitored flexible limit 11
82.12 AM Flexible limit 12	AM Monitored flexible limit 12
82.13 AM Flexible limit 13	AM Monitored flexible limit 13
82.14 AM Flexible limit 14	AM Monitored flexible limit 14
82.15 AM Flexible limit 15	AM Monitored flexible limit 15
82.16 AM Flexible limit 16	AM Monitored flexible limit 16
82.17 AM Flexible limit 17	AM Monitored flexible limit 17
82.18 AM Flexible limit 18	AM Monitored flexible limit 18
82.19 AM Flexible limit 19	AM Monitored flexible limit 19
82.20 AM Flexible limit 20	AM Monitored flexible limit 20
82.21 AM Flexible limit 21	AM Monitored flexible limit 21
82.22 AM Flexible limit 22	AM Monitored flexible limit 22
82.23 AM Flexible limit 23	AM Monitored flexible limit 23
82.24 AM Flexible limit 24	AM Monitored flexible limit 24
82.25 AM Flexible limit 25	AM Monitored flexible limit 25
82.26 AM Flexible limit 26	AM Monitored flexible limit 26
82.27 AM Flexible limit 27	AM Monitored flexible limit 27
82.28 AM Flexible limit 28	AM Monitored flexible limit 28
82.29 AM Flexible limit 29	AM Monitored flexible limit 29
82.30 AM Flexible limit 30	AM Monitored flexible limit 30
82.31 AM Flexible limit 31	AM Monitored flexible limit 31
82.32 AM Flexible limit 32	AM Monitored flexible limit 32
82.33 AM Flexible limit 33	AM Monitored flexible limit 33
82.34 AM Flexible limit 34	AM Monitored flexible limit 34
82.35 AM Flexible limit 35	AM Monitored flexible limit 35

HMI Text	Note
82.36 AM Flexible limit 36	AM Monitored flexible limit 36
82.37 AM Flexible limit 37	AM Monitored flexible limit 37
82.38 AM Flexible limit 38	AM Monitored flexible limit 38
82.39 AM Flexible limit 39	AM Monitored flexible limit 39
82.40 AM Flexible limit 40	AM Monitored flexible limit 40

9.3.2.33 Group 86: LM Results 1

TRUE if the result of the corresponding LogicsManager equation is true.

HMI Text	Note
86.09 LM: Start req.in AUTO	LM Start request in automatic mode
86.10 LM: Stop req. in AUTO	LM Stop request in automatic mode
86.11 LM: Inhibit emerg.run	LM Inhibit or interrupt emergency run
86.12 LM: Undelay close GCB	LM Undelayed close GCB
86.13 LM: LS interf. EthA	LM Load share interface Ethernet A
86.14 LM: Constant idle run	LM Constant Idle Run is requested
86.15 LM: Ext. acknowledge	LM External acknowledge
86.16 LM: Operat. mode AUTO	LM External "Set mode Auto"
86.17 LM: Operat. mode MAN	LM External "Set mode Man"
86.18 LM: Operat. mode STOP	LM External "Set mode Stop"
86.19 LM: Start w/o load	LM Start without load
86.20 LM: Auto idle mode	LM Automatic Idle Run is requested
86.21 LM: Discrete f/P +	LM Frequency / Active Power Setpoint raise
86.22 LM: Discrete f/P -	LM Frequency / Active Power Setpoint low
86.23 LM: Discrete V/PF +	LM Voltage / Reactive Power Setpoint raise
86.24 LM: Discrete V/PF -	LM Voltage / Reactive Power Setpoint low
86.25 LM: Freq. droop act.	LM Frequency Droop active
86.26 LM: Volt. droop act.	LM Voltage Droop active
86.27 LM: Ext. mns.decoupl.	LM Mains failure by external device is requested
86.28 LM: Critical mode	LM Critical mode is requested
86.29 LM: Operat. mode TEST	LM External "Set mode Test"
86.30 LM: Lock keypad 1	LM Lock keypad 1
86.31 LM: ECU seq. B_IN_1	LM ECU sequencer binary input 1
86.32 LM: ECU seq. B_IN_2	LM ECU sequencer binary input 2
86.33 LM: 2nd disp.bright.	LM Enable second display brightness
86.34 LM: Enable heater	LM Enable Front Foil Heater
86.35 LM: Syst. update	LM System update
86.36 LM: LDSS predicted	LM LDSS with predicted load

HMI Text	Note
86.38 LM: Syn. mode CHECK	LM Synchronization mode CHECK
86.39 LM: Syn. mode PERMIS.	LM Synchronization mode PERMISSIVE
86.40 LM: Syn. mode RUN	LM Synchronization mode RUN
86.41 LM: IOP Res.power 2	LM IOP Reserve Power 2
86.42 LM: MOP Res.power 2	LM MOP Reserve Power 2
86.43 LM: RP Full mode	LM Remote Panel "Full Mode"
86.44 LM: RP Annunciator	LM Remote Panel "Annunciator mode"
86.45 LM: RP Off mode	LM Remote Panel "Off mode"
86.46 LM: AVR V(f) enabled	LM: Automatic voltage regulator V(f) characteristic enabled (Does not apply to EG3200XT-P1)
86.48 LM: Inhibit regener.	LM: DPF "Inhibit regeneration" (SPN 3695: "DPF Regeneration Inhibit Switch")
86.49 LM: Force regener.	LM: DPF "Force regeneration" (SPN 3696: "DPF Regeneration Force Switch")
86.50 LM: Bypass preglow	LM: Bypass the configured preglow time
86.51 LM: Open GCB immed.	LM: Open GCB immediately
86.81 LM: Setpoint 2 freq.	LM Setpoint 2 Frequency
86.82 LM: Setp. 2 load	LM Setpoint 2 Active Power
86.83 LM: Setp. 2 voltage	LM Setpoint 2 Voltage
86.84 LM: Setp.2 pwr.factor	LM Setpoint 2 Reactive Power
86.85 LM: Enable MCB	LM Enable MCB
86.86 LM: LDSS enabled	LM activate load dependend start stop
86.87 LM: Segment no.2 act.	LM set group / node number to 2 for load share
86.88 LM: Segment no.3 act.	LM set group / node number to 3 for load share
86.89 LM: Segment no.4 act.	LM set group / node number to 4 for load share
86.90 LM: LDSS Priority 2	LM load dependend start/stop priority 2
86.91 LM: LDSS Priority 3	LM load dependend start/stop priority 3
86.92 LM: LDSS Priority 4	LM load dependend start/stop priority 4
86.93 LM: Transition mode 1	LM Breaker Transition Mode Alternative 1
86.94 LM: Transition mode 2	LM Breaker Transition Mode Alternative 2
86.95 LM: Enable GCB	LM Enable GCB
86.96 LM: Release f-control	LM Release Frequency control
86.97 LM: Release V-control	LM Release Voltage control
86.98 LM: P-control active	LM Active power control active
86.99 LM: Q control active	LM React.power control active

9.3.2.34 Group 87: LM Results 2

TRUE if the result of the corresponding LogicsManager equation is true.

HMI Text	Note
87.17 LM: PID1 ctrl.release	LM Free PID 1 Control Release
87.18 LM: PID2 ctrl.release	LM Free PID 2 Control Release
87.19 LM: PID3 ctrl.release	LM Free PID 3 Control Release
87.23 LM: LSx command 1	LM: System command 1
87.24 LM: LSx command 2	LM: System command 2
87.25 LM: LSx command 3	LM: System command 3
87.26 LM: LSx command 4	LM: System command 4
87.27 LM: LSx command 5	LM: System command 5
87.28 LM: LSx command 6	LM: System command 6
87.29 LM: Bypass min. Pgen.	LM Bypass minimum generator power for closing GGB
87.30 LM: Run-up sync.	LM Run up synchronisation
87.31 LM: Enable Mns dec.	LM Enable Mains Decoupling
87.36 LM: Open GGB immed.	LM: Open GGB immediately
87.37 LM: Enable GGB	LM: Enable GGB
87.46 LM: GCB open in MAN	LM Open GCB in Manual
87.47 LM: GCB close in MAN	LM Close GCB in Manual
87.48 LM: MCB open in MAN	LM Open MCB in Manual
87.49 LM: MCB close in MAN	LM Close MCB in Manual
87.50 LM: MAN engine start	LM Start Engine in Manual
87.59 LM: MAN engine stop	LM Stop Engine in Manual
87.60 LM: Free derating	LM Enable freely derating
87.61 LM: GGB open in MAN	LM Open GGB in Manual
87.62 LM: GGB close in MAN	LM Close GGB in Manual
87.66 LM: Inhibit cranking	LM: Inhibit cranking
87.67 LM: Setp. 3 load	LM Setpoint 3 Active Power
87.68 LM: Firing speed	LM Firing speed detection
87.69 LM: Speed detected	LM Speed detection
87.70 LM: Release eng.mon.	LM Release engine monitoring
87.71 LM: Release cyl.temp.	LM Release cylinder temperature deviation monitoring
87.72 LM: Disable mns.mon.	LM Disable mains monitoring
87.73 LM: Mains decoupl.MCB	LM Mains decoupling MCB
87.74 LM: Inh.dead bus GCB	LM Inhibit dead bus GCB
87.75 LM: Setp. 4 load	LM Setpoint 4 Active Power
87.76 LM: Disable load ramp	LM Disable load control ramp
87.77 LM: 2nd load SP ramp	LM Enable 2nd load setpoint ramp
87.78 LM: 2nd frequency PID	LM Enable 2nd Frequency PID
87.79 LM: 3rd load SP ramp	LM Enable 3rd load setpoint ramp
87.80 LM: PV regulation	LM Release PV load regulation

HMI Text	Note
87.89 LM: Lamp test	LM: Lamp test is active
87.96 LM: PV breaker closed	PV breaker is closed
87.97 LM: Gen.group1 closed	Breaker Gen. group 1 is closed
87.98 LM: Gen.group2 closed	Breaker Gen. group 2 is closed

9.3.2.35 Group 88: LM Results 3 (Free alarms)

TRUE if the result of the corresponding LogicsManager equation is true.

HMI Text	Note
88.01 LM: Free alarm 1	LM Free alarm 1 active
88.02 LM: Free alarm 2	LM Free alarm 2 active
88.03 LM: Free alarm 3	LM Free alarm 3 active
88.04 LM: Free alarm 4	LM Free alarm 4 active
88.05 LM: Free alarm 5	LM Free alarm 5 active
88.06 LM: Free alarm 6	LM Free alarm 6 active
88.07 LM: Free alarm 7	LM Free alarm 7 active
88.08 LM: Free alarm 8	LM Free alarm 8 active
88.09 LM: Free alarm 9	LM Free alarm 9 active
88.10 LM: Free alarm 10	LM Free alarm 10 active
88.11 LM: Free alarm 11	LM Free alarm 11 active
88.12 LM: Free alarm 12	LM Free alarm 12 active
88.13 LM: Free alarm 13	LM Free alarm 13 active
88.14 LM: Free alarm 14	LM Free alarm 14 active
88.15 LM: Free alarm 15	LM Free alarm 15 active
88.16 LM: Free alarm 16	LM Free alarm 16 active
88.17 LM: Free alarm 17	LM Free alarm 17 active
88.18 LM: Free alarm 18	LM Free alarm 18 active
88.19 LM: Free alarm 19	LM Free alarm 19 active
88.20 LM: Free alarm 20	LM Free alarm 20 active
88.21 LM: Free alarm 21	LM Free alarm 21 active
88.22 LM: Free alarm 22	LM Free alarm 22 active
88.23 LM: Free alarm 23	LM Free alarm 23 active
88.24 LM: Free alarm 24	LM Free alarm 24 active
88.25 LM: Free alarm 25	LM Free alarm 25 active
88.26 LM: Free alarm 26	LM Free alarm 26 active
88.27 LM: Free alarm 27	LM Free alarm 27 active
88.28 LM: Free alarm 28	LM Free alarm 28 active
88.29 LM: Free alarm 29	LM Free alarm 29 active

HMI Text	Note
88.30 LM: Free alarm 30	LM Free alarm 30 active
88.31 LM: Free alarm 31	LM Free alarm 31 active
88.32 LM: Free alarm 32	LM Free alarm 32 active

9.3.2.36 Group 90: AnalogManager Internal values 0 (Customer screens)

TRUE if the boolean result of the corresponding AnalogManager equation is true.

HMI Text	Note
90.01 AM Cust.screen 1.1	AM Customer screen 1 row 1
90.02 AM Cust.screen 1.2	AM Customer screen 1 row 2
90.03 AM Cust.screen 1.3	AM Customer screen 1 row 3
90.04 AM Cust.screen 1.4	AM Customer screen 1 row 4
90.05 AM Cust.screen 1.5	AM Customer screen 1 row 5
90.06 AM Cust.screen 1.6	AM Customer screen 1 row 6
90.07 AM Cust.screen 1.7	AM Customer screen 1 row 7
90.08 AM Cust.screen 1.8	AM Customer screen 1 row 8
90.09 AM Cust.screen 1.9	AM Customer screen 1 row 9
90.51 AM Cust.screen 2.1	AM Customer screen 2 row 1
90.52 AM Cust.screen 2.2	AM Customer screen 2 row 2
90.53 AM Cust.screen 2.3	AM Customer screen 2 row 3
90.54 AM Cust.screen 2.4	AM Customer screen 2 row 4
90.55 AM Cust.screen 2.5	AM Customer screen 2 row 5
90.56 AM Cust.screen 2.6	AM Customer screen 2 row 6
90.57 AM Cust.screen 2.7	AM Customer screen 2 row 7
90.58 AM Cust.screen 2.8	AM Customer screen 2 row 8
90.59 AM Cust.screen 2.9	AM Customer screen 2 row 9

9.3.2.37 Group 91: AnalogManager Internal values 1

TRUE if the boolean result of the corresponding AnalogManager equation is true.

HMI Text	Note
91.01 AM Internal value 1	
91.02 AM Internal value 2	
91.03 AM Internal value 3	
91.04 AM Internal value 4	
91.05 AM Internal value 5	
91.06 AM Internal value 6	
91.07 AM Internal value 7	

HMI Text	Note
91.08 AM Internal value 8	
91.09 AM Internal value 9	
91.10 AM Internal value 10	
91.11 AM Internal value 11	
91.12 AM Internal value 12	
91.13 AM Internal value 13	
91.14 AM Internal value 14	
91.15 AM Internal value 15	
91.16 AM Internal value 16	

9.3.2.38 Group 93: AnalogManager Analog outputs 1

TRUE if the boolean result of the corresponding AnalogManager equation is true.

HMI Text	Note
93.01 AM Data source AO1	AM Analog output 1 data source
93.02 AM Data source AO2	AM Analog output 2 data source
93.03 AM Data source AO3	AM Analog output 3 data source
93.04 AM Data source AO4	AM Analog output 4 data source
93.05 AM Data source AO5	AM Analog output 5 data source
93.06 AM Data source AO6	AM Analog output 6 data source
93.21 AM Data s. ext. AO1	AM External Analog output 1 data source
93.22 AM Data s. ext. AO2	AM External Analog output 2 data source
93.23 AM Data s. ext. AO3	AM External Analog output 3 data source
93.24 AM Data s. ext. AO4	AM External Analog output 4 data source

9.3.2.39 Group 96: LM Internal flags 1

TRUE if the result of the corresponding LogicsManager equation is true.

HMI Text	Note
96.01 LM: Flag 1	LM Internal flag 1
96.02 LM: Flag 2	LM Internal flag 2
96.03 LM: Flag 3	LM Internal flag 3
96.04 LM: Flag 4	LM Internal flag 4
96.05 LM: Flag 5	LM Internal flag 5
96.06 LM: Flag 6	LM Internal flag 6
96.07 LM: Flag 7	LM Internal flag 7
96.08 LM: Flag 8	LM Internal flag 8
96.09 LM: Flag 9	LM Internal flag 9

HMI Text	Note
96.10 LM: Flag 10	LM Internal flag 10
96.11 LM: Flag 11	LM Internal flag 11
96.12 LM: Flag 12	LM Internal flag 12
96.13 LM: Flag 13	LM Internal flag 13
96.14 LM: Flag 14	LM Internal flag 14
96.15 LM: Flag 15	LM Internal flag 15
96.16 LM: Flag 16	LM Internal flag 16
96.17 LM: Flag 17	LM Internal flag 17
96.18 LM: Flag 18	LM Internal flag 18
96.19 LM: Flag 19	LM Internal flag 19
96.20 LM: Flag 20	LM Internal flag 20
96.21 LM: Flag 21	LM Internal flag 21
96.22 LM: Flag 22	LM Internal flag 22
96.23 LM: Flag 23	LM Internal flag 23
96.24 LM: Flag 24	LM Internal flag 24
96.25 LM: Flag 25	LM Internal flag 25
96.26 LM: Flag 26	LM Internal flag 26
96.27 LM: Flag 27	LM Internal flag 27
96.28 LM: Flag 28	LM Internal flag 28
96.29 LM: Flag 29	LM Internal flag 29
96.30 LM: Flag 30	LM Internal flag 30
96.31 LM: Flag 31	LM Internal flag 31
96.32 LM: Flag 32	LM Internal flag 32

9.3.2.40 Group 98: LM External DOs 1

TRUE if the result of the corresponding LogicsManager equation is true.

HMI Text	Note
98.01 LM: External DO 1	
98.02 LM: External DO 2	
98.03 LM: External DO 3	
98.04 LM: External DO 4	
98.05 LM: External DO 5	
98.06 LM: External DO 6	
98.07 LM: External DO 7	
98.08 LM: External DO 8	
98.09 LM: External DO 9	
98.10 LM: External DO 10	

HMI Text	Note
98.11 LM: External DO 11	
98.12 LM: External DO 12	
98.13 LM: External DO 13	
98.14 LM: External DO 14	
98.15 LM: External DO 15	
98.16 LM: External DO 16	
98.17 LM: External DO 17	
98.18 LM: External DO 18	
98.19 LM: External DO 19	
98.20 LM: External DO 20	
98.21 LM: External DO 21	
98.22 LM: External DO 22	
98.23 LM: External DO 23	
98.24 LM: External DO 24	
98.25 LM: External DO 25	
98.26 LM: External DO 26	
98.27 LM: External DO 27	
98.28 LM: External DO 28	
98.29 LM: External DO 29	
98.30 LM: External DO 30	
98.31 LM: External DO 31	
98.32 LM: External DO 32	

9.3.2.41 Group 99: LM Internal DOs 1

TRUE if the result of the corresponding LogicsManager equation is true.

HMI Text	Note
99.01 LM: Ready for op. OFF	LM Relay 1 ready for operation (This flag has negative logic: if the LM flag is true, the relay is not energized.)
99.02 LM: Relay 2	
99.03 LM: Relay 3	
99.04 LM: Relay 4	
99.05 LM: Relay 5	
99.06 LM: Relay 6	
99.07 LM: Relay 7	
99.08 LM: Relay 8	
99.09 LM: Relay 9	
99.10 LM: Relay 10	

HMI Text	Note
99.11 LM: Relay 11	
99.12 LM: Relay 12	
99.13 LM: Relay 13	
99.14 LM: Relay 14	
99.15 LM: Relay 15	
99.16 LM: Relay 16	
99.17 LM: Relay 17	
99.18 LM: Relay 18	
99.19 LM: Relay 19	
99.20 LM: Relay 20	
99.21 LM: Relay 21	
99.22 LM: Relay 22	
99.33 LM: Transistor out 1	LM: Transistor output 1
99.34 LM: Transistor out 2	LM: Transistor output 2

9.3.3 Logical Symbols

The following symbols are used for the graphical programming of the LogicsManager. The symbols are shown according to the IEC standard by default.

- Use parameter  4117 to change display mode to ASA standard.

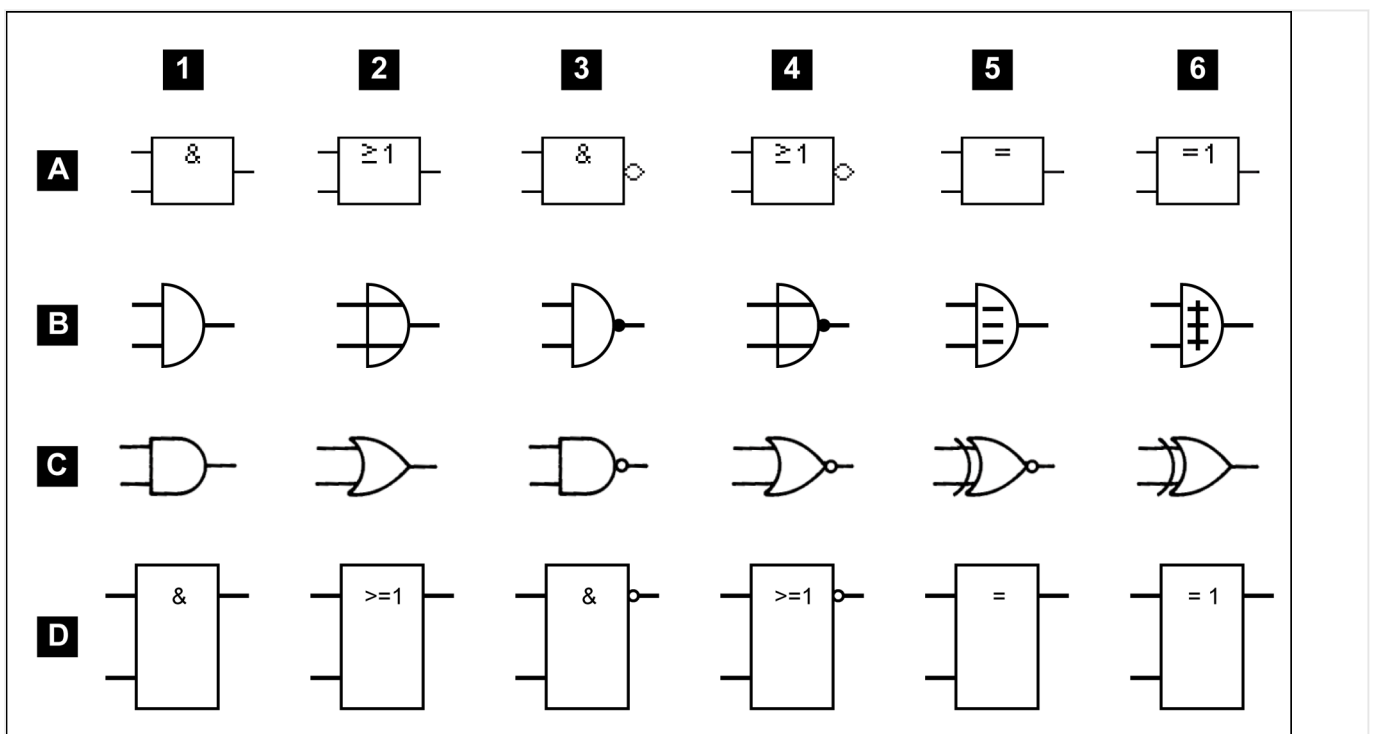

Fig. 422: Logical symbols

Row	... according to standard:
A	IEC (default)
B	DIN 40 700
C	ASA US MIL (configurable)
D	IEC617-12

Meaning of the columns					
1	2	3	4	5	6
AND	OR	NAND	NOR	NXOR	XOR

AND				OR				NAND				NOR				NXOR				XOR		
x1	x2	y		x1	x2	y		x1	x2	y		x1	x2	y		x1	x2	y		x1	x2	y
0	0	0		0	0	0		0	0	1		0	0	1		0	0	1		0	0	0
0	1	0		0	1	1		0	1	1		0	1	0		0	1	0		0	1	1
1	0	0		1	0	1		1	0	1		1	0	0		1	0	0		1	0	1
1	1	1		1	1	1		1	1	0		1	1	0		1	1	1		1	1	0

Table 160: Truth table

9.3.4 Logical Outputs

The logical outputs or combinations may be grouped into three categories:

- Internal logical flags
- Internal functions
- Relay outputs



The numbers of the logical outputs in the third column may again be used as input variable for other outputs in the LogicsManager.

Internal flags

32 internal logical flags may be programmed to activate/deactivate functions. This permits more than 3 commands to be included in a logical function. They may be used like "auxiliary flags".

Name	Function	ID
96.01 LM: Flag 1	Internal flag 1	10700
96.02 LM: Flag 2	Internal flag 2	10701
96.03 LM: Flag 3	Internal flag 3	10702

Name	Function	ID
96.04 LM: Flag 4	Internal flag 4	10703
96.05 LM: Flag 5	Internal flag 5	10704
96.06 LM: Flag 6	Internal flag 6	10705
96.07 LM: Flag 7	Internal flag 7	10706
96.08 LM: Flag 8	Internal flag 8	10707
96.09 LM: Flag 9	Internal flag 9	11609
96.10 LM: Flag 10	Internal flag 10	11610
96.11 LM: Flag 11	Internal flag 11	11611
96.12 LM: Flag 12	Internal flag 12	11612
96.13 LM: Flag 13	Internal flag 13	11613
96.14 LM: Flag 14	Internal flag 14	11614
96.15 LM: Flag 15	Internal flag 15	11615
96.16 LM: Flag 16	Internal flag 16	11616
96.17 LM: Flag 17	Internal flag 17	12232
96.18 LM: Flag 18	Internal flag 18	12234
96.19 LM: Flag 19	Internal flag 19	12236
96.20 LM: Flag 20	Internal flag 20	12238
96.21 LM: Flag 21	Internal flag 21	12242
96.22 LM: Flag 22	Internal flag 22	12244
96.23 LM: Flag 23	Internal flag 23	12246
96.24 LM: Flag 24	Internal flag 24	12248
96.25 LM: Flag 25	Internal flag 25	12252
96.26 LM: Flag 26	Internal flag 26	12254
96.27 LM: Flag 27	Internal flag 27	12256
96.28 LM: Flag 28	Internal flag 28	12258
96.29 LM: Flag 29	Internal flag 29	12262
96.30 LM: Flag 30	Internal flag 30	12264
96.31 LM: Flag 31	Internal flag 31	12266
96.32 LM: Flag 32	Internal flag 32	12268

Internal functions

The following logical functions may be used to activate/deactivate functions.

Name	Function	ID
86.09 LM: Start req.in AUTO	Start in AUTOMATIC operating mode (parameter ↩️➡️ 12120)	10708
86.10 LM: Stop req. in AUTO	Stop in AUTOMATIC operating mode (parameter ↩️➡️ 12190)	10709
86.11 LM: Inhibit emerg.run	Blocking or interruption of an emergency power operating in AUTOMATIC operating mode (parameter ↩️➡️ 12200)	10710
86.12 LM: Undelay close GCB	Immediately closing of the GCB after engine start without waiting for the engine delayed monitoring and generator stable timer to expire (parameter ↩️➡️ 12210)	10711
86.13 LM: LS interf. EthA	Enables to switch load share interface between CAN and Ethernet A (parameter ↩️➡️ 11986)	11987
86.14 LM: Constant idle run	Enables idle/rated speed modes (parameter ↩️➡️ 12550).	10713
86.15 LM: Ext. acknowledge	The alarm acknowledgement is performed from an external source (parameter ↩️➡️ 12490)	10714
86.16 LM: Operat. mode AUTO	Activation of the AUTOMATIC operating mode (parameter ↩️➡️ 12510)	10715
86.17 LM: Operat. mode MAN	Activation of the MANUAL operating mode (parameter ↩️➡️ 12520)	10716
86.18 LM: Operat. mode STOP	Activation of the STOP operating mode (parameter ↩️➡️ 12530)	10717
86.19 LM: Start w/o load	Starting the engine without closing the GCB (parameter ↩️➡️ 12540)	10718
86.20 LM: Auto idle mode	Automatic idle mode (blocks the undervoltage, underfrequency, and underspeed monitoring for a configured time automatically, parameter ↩️➡️ 12570)	10719
86.21 LM: Discrete f/P +	Raise frequency / real power setpoint (parameter ↩️➡️ 12900)	11600
86.22 LM: Discrete f/P -	Lower frequency / real power setpoint (parameter ↩️➡️ 12901)	11601
L86.23 LM: Discrete V/PF +	Raise voltage / power factor setpoint (parameter ↩️➡️ 12902)	11602
86.24 LM: Discrete V/PF -	Lower voltage / power factor setpoint (parameter ↩️➡️ 12903)	11603
86.25 LM: Freq. droop act.	Activation of the frequency droop (parameter ↩️➡️ 12904)	11604
86.26 LM: Volt. droop act.	Activation of the voltage droop (parameter ↩️➡️ 12905)	11605
86.27 LM: Ext. mns.decoup.	Activation of the mains decoupling function (parameter ↩️➡️ 12922)	11606
86.28 LM: Critical mode	Activation of critical mode operation (parameter ↩️➡️ 12220)	11607

Name	Function	ID
86.29 LM: Operat. mode TEST	Activation of the TEST operating mode (parameter ↩️ 12271)	12272
86.30 LM: Lock keypad 1	Activation of the Lock keypad 1 (parameter ↩️ 12978)	11924
86.31 LM: ECU seq. B_IN_1	Activation of a special ECU function (parameter ↩️ 15164) depending on the selected ECU	11647
86.32 LM: ECU seq. B_IN_2	Activation of a special ECU function (parameter ↩️ 15165) depending on the selected ECU	11648
86.33 LM: 2nd disp.bright.	Enabling of the 2nd display brightness (parameter ↩️ 7794)	11971
86.34 LM: Enable heater	Enabling of the front foil heater (parameter ↩️ 7799)	11972
86.35 LM: Syst. update	Trigger system update (parameter ↩️ 7801)	11974
86.38 LM: Syn. mode CHECK	Activation of CHECK synchronization mode (parameter ↩️ 12906)	11617
86.39 LM: Syn. mode PERMIS.	Activation of PERMISSIVE synchronization mode (parameter ↩️ 12907)	11618
86.40 LM: Syn. mode RUN	Activation of RUN synchronization mode (parameter ↩️ 12908) edge controlled	11619
86.41 LM: IOP Res.power 2	Select IOP Reserve power 2 (parameter ↩️ 12604)	11975
86.42 LM: MOP Res.power 2	Select MOP Reserve power 2 (parameter ↩️ 12605)	11976
86.43 LM: RP Full mode	Select remote panel full mode (parameter ↩️ 7857)	11994
86.44 LM: RP Annunciator	Select remote panel annunciator mode (parameter ↩️ 7858)	11995
86.45 LM: RP Off mode	Select remote panel off mode (parameter ↩️ 7859)	11996
86.46 LM: AVR V(f) enabled	Enable AVR V(f) characteristic (parameter ↩️ 12037)	10848
86.50 LM: Bypass preglow	Bypass the configured preglow time (parameter ↩️ 12885)	11658
86.51 LM: Open GCB immed.	Open the GCB immediately (parameter ↩️ 12886)	12052
86.81 LM: Setpoint 2 freq.	Activates the frequency setpoint 2 (parameter ↩️ 12918)	11910
86.82 LM: Setp. 2 load	Activates the load setpoint 2 (parameter ↩️ 12919)	11911
86.83 LM: Setp. 2 voltage	Activates the voltage setpoint 2 (parameter ↩️ 12920)	11912

Name	Function	ID
86.84 LM: Setp.2 pwr.factor	Activates the power factor setpoint 2 (parameter ↩️ 12921)	11913
86.85 LM: Enable MCB	Enables the MCB (parameter ↩️ 12923)	11914
86.86 LM: LDSS enabled	Activation of load-dependent start/stop (parameter ↩️ 12930)	11915
86.87 LM: Segment no.2 act.	Assigns the genset to load share segm. #2 (parameter ↩️ 12929)	11916
86.88 LM: Segment no.3 act.	Assigns the genset to load share segm. #3 (parameter ↩️ 12928)	11917
86.89 LM: Segment no.4 act.	Assigns the genset to load share segm. #4 (parameter ↩️ 12927)	11918
86.90 LM: LDSS Priority 2	Sets the LDSS priority to 2 (parameter ↩️ 12926)	11919
86.91 LM: LDSS Priority 3	Sets the LDSS priority to 3 (parameter ↩️ 12925)	11920
86.92 LM: LDSS Priority 4	Sets the LDSS priority to 4 (parameter ↩️ 12924)	11921
86.93 LM: Transition mode 1	Activates breaker transition mode 1 (parameter ↩️ 12931)	11922
86.94 LM: Transition mode 2	Activates breaker transition mode 2 (parameter ↩️ 12932)	11923
86.95 LM: Enable GCB	Enables the GCB (parameter ↩️ 12887)	12051
86.96 LM: Release f-control	Release frequency control (parameter ↩️ 12909)	11925
86.97 LM: Release V-control	Release voltage control (parameter ↩️ 12938)	11926
86.98 LM: P-control active	Activates P-control (parameter ↩️ 12940)	11927
86.99 LM: Q control active	Activates Q-control (parameter ↩️ 12941)	11928
87.17 LM: PID1 ctrl.release	Release PID1 control (parameter ↩️ 5580)	11406
87.18 LM: PID2 ctrl.release	Release PID2 control (parameter ↩️ 5593)	11407
87.19 LM: PID3 ctrl.release	Release PID3 control (parameter ↩️ 5679)	11408
87.23 LM: LSx command 1	Activates LSx command 1 (parameter ↩️ 12979)	11412
87.24 LM: LSx command 2	Activates LSx command 2 (parameter ↩️ 12980)	11413

Name	Function	ID
87.25 LM: LSx command 3	Activates LSx command 3 (parameter ↩️ 12981)	11414
87.26 LM: LSx command 4	Activates LSx command 4 (parameter ↩️ 12982)	11415
87.27 LM: LSx command 5	Activates LSx command 5 (parameter ↩️ 12983)	11416
87.28 LM: LSx command 6	Activates LSx command 6 (parameter ↩️ 12984)	11417
87.29 LM: Bypass min. Pgen.	Bypass minimum generator power for GGB (parameter ↩️ 12936)	11418
87.30 LM: Run-up sync.	Activates Run-up synchronizaton (parameter ↩️ 12937)	11419
87.31 LM: Enable Mns dec.	Enables mains decoupling (parameter ↩️ 12942)	11420
87.36 LM: Open GGB immed.	Open the GGB immediately (parameter ↩️ 12947)	11425
87.37 LM: Enable GGB	Enable the GGB (parameter ↩️ 12948)	11426
87.46 LM: GCB open in MAN	Opens GCB in manual (parameter ↩️ 12976)	11435
87.47 LM: GCB close in MAN	Closes GCB in manual (parameter ↩️ 12977)	11436
87.48 LM: MCB open in MAN	Opens MCB in manual (parameter ↩️ 12974)	11437
87.49 LM: MCB close in MAN	Closes MCB in manual (parameter ↩️ 12975)	11438
87.50 LM: MAN engine start	Starts the engine in manual (parameter ↩️ 12970)	11439
87.59 LM: MAN engine stop	Stops the engine in manual (parameter ↩️ 12971)	11448
87.60 LM: Free derating	Activates free derating (parameter ↩️ 15146)	11449
87.61 LM: GGB open in MAN	Opens GGB in manual (parameter ↩️ 12972)	11450
87.62 LM: GGB close in MAN	Closes GGB in manual (parameter ↩️ 12973)	11451
87.66 LM: Inhibit cranking	Inhibits cranking (parameter ↩️ 4871)	11455
87.67 LM: Setp. 3 load	Activates the load setpoint 3 (parameter ↩️ 12998)	11456
87.68 LM: Firing speed	Activate firing speed detected flag (parameter ↩️ 12951)	11457

Name	Function	ID
87.69 LM: Speed detected	Activate speed detected flag (parameter ↩> 12989)	11458
87.70 LM: Release eng.mon.	Release engine monitoring (parameter ↩> 12999)	11459
87.71 LM: Release cyl.temp.	Release cylinder temperature deviation monitoring (parameter ↩> 15158)	11460
87.72 LM: Disable mns.mon.	Disables mains monitoring (parameter ↩> 15159)	11461
87.73 LM: Mains decoupl.MCB	Enables mains decoupling via MCB (parameter ↩> 15160)	11462
87.74 LM: Inh.dead bus GCB	Inhibit dead bus closure GCB (parameter ↩> 15161)	11463
87.75 LM: Setp. 4 load	Activates the load setpoint 4 (parameter ↩> 12269)	11464
87.76 LM: Disable load ramp	Disable load setpoint ramp (parameter ↩> 12853)	11465
87.77 LM: 2nd load SP ramp	Select 2nd load control setpoint ramp (parameter ↩> 11978)	11979
87.79 LM: 3rd load SP ramp	Select 3rd load control setpoint ramp (parameter ↩> 11998)	11999
87.80 LM: PV regulation	Release PV regulation (parameter ↩> 8928)	8929
88.01 LM: Free alarm 1	Select source of free alarm 1 (parameter ↩> 8120)	11550
88.02 LM: Free alarm 2	Select source of free alarm 2 (parameter ↩> 8124)	11551
88.03 LM: Free alarm 3	Select source of free alarm 3 (parameter ↩> 8128)	11552
88.04 LM: Free alarm 4	Select source of free alarm 4 (parameter ↩> 8132)	11553
88.05 LM: Free alarm 5	Select source of free alarm 5 (parameter ↩> 8136)	11554
88.06 LM: Free alarm 6	Select source of free alarm 6 (parameter ↩> 8140)	11555
88.07 LM: Free alarm 7	Select source of free alarm 7 (parameter ↩> 8144)	11556
88.08 LM: Free alarm 8	Select source of free alarm 8 (parameter ↩> 8148)	11557
88.09 LM: Free alarm 9	Select source of free alarm 9 (parameter ↩> 8154)	11558
88.10 LM: Free alarm 10	Select source of free alarm 10 (parameter ↩> 8158)	11559

Name	Function	ID
88.11 LM: Free alarm 11	Select source of free alarm 11 (parameter ↩ 8165)	11560
88.12 LM: Free alarm 12	Select source of free alarm 12 (parameter ↩ 8170)	11561
88.13 LM: Free alarm 13	Select source of free alarm 13 (parameter ↩ 8174)	11562
88.14 LM: Free alarm 14	Select source of free alarm 14 (parameter ↩ 8178)	11563
88.15 LM: Free alarm 15	Select source of free alarm 15 (parameter ↩ 8182)	11564
88.16 LM: Free alarm 16	Select source of free alarm 16 (parameter ↩ 8186)	11565

Priority hierarchy of the logical outputs

The following table contains the priority relationships between the start conditions of the logical outputs in the LogicsManager:

Prioritized function	Overrides	Reaction
Critical mode	Stop req. in AUTO	A start will still be performed.
	Start req. in AUTO	The behavior of the system depends on the configuration of the related parameters.
Stop req. in AUTO	Start req. in AUTO	No start will be performed.
	Emergency	No start will be performed.
	Idle mode	No start will be performed.
Start w/o load	Start req. in AUTO	The GCB remains open / will be opened.
Emergency	Start w/o load	The GCB will be closed nevertheless.
	Critical mode	The GCB will be closed nevertheless. The alarm class management is still performed like for the critical mode. If emergency power is already enabled and the critical mode will be enabled then, a pause time may be configured for the emergency power operation.
Inhibit emerg.run	Emergency	No start will be performed.
	Emergency during Start w/o load	The generator keeps on running without taking over load.

Relay outputs

All relays may be controlled directly by the LogicsManager depending on the respective application mode.

Name LM:	Function	ID
99.01 LM: Ready for op. OFF (Ready for operation OFF)	If this logical output becomes true, the relay output 1 will be deactivated	11870

Name LM:	Function	ID
99.02 LM: Relay 2	If this logical output becomes true, the relay output 2 will be activated	11871
99.03 LM: Relay 3	If this logical output becomes true, the relay output 3 will be activated	11872
99.04 LM: Relay 4	If this logical output becomes true, the relay output 4 will be activated	11873
99.05 LM: Relay 5	If this logical output becomes true, the relay output 5 will be activated	11874
99.06 LM: Relay 6	If this logical output becomes true, the relay output 6 will be activated	11875
99.07 LM: Relay 7	If this logical output becomes true, the relay output 7 will be activated	11876
99.08 LM: Relay 8	If this logical output becomes true, the relay output 8 will be activated	11877
99.09 LM: Relay 9	If this logical output becomes true, the relay output 9 will be activated	11878
99.10 LM: Relay 10	If this logical output becomes true, the relay output 10 will be activated	11879
99.11 LM: Relay 11	If this logical output becomes true, the relay output 11 will be activated	11880
99.12 LM: Relay 12	If this logical output becomes true, the relay output 12 will be activated	11881

Name	Function	ID
99.13 LM: Relay 13	If this logical output becomes true, the relay output 2 will be activated	11882
99.14 LM: Relay 14	If this logical output becomes true, the relay output 3 will be activated	11883
99.15 LM: Relay 15	If this logical output becomes true, the relay output 4 will be activated	11884
99.16 LM: Relay 16	If this logical output becomes true, the relay output 5 will be activated	11885
99.17 LM: Relay 17	If this logical output becomes true, the relay output 6 will be activated	11886
99.18 LM: Relay 18	If this logical output becomes true, the relay output 7 will be activated	11887
99.19 LM: Relay 19	If this logical output becomes true, the relay output 8 will be activated	11888
99.20 LM: Relay 20	If this logical output becomes true, the relay output 9 will be activated	11889

Name	Function	ID
99.21 LM: Relay 21	If this logical output becomes true, the relay output 10 will be activated	11890
99.22 LM: Relay 22	If this logical output becomes true, the relay output 11 will be activated	11891

Name	Function	ID
External DO 1	If this logical output becomes true, the external relay output 1 will be activated	11892
External DO 2	If this logical output becomes true, the external relay output 2 will be activated	11893
External DO 3	If this logical output becomes true, the external relay output 3 will be activated	11894
External DO 4	If this logical output becomes true, the external relay output 4 will be activated	11895
External DO 5	If this logical output becomes true, the external relay output 5 will be activated	11896
External DO 6	If this logical output becomes true, the external relay output 6 will be activated	11897
External DO 7	If this logical output becomes true, the external relay output 7 will be activated	11898
External DO 8	If this logical output becomes true, the external relay output 8 will be activated	11899
External DO 9	If this logical output becomes true, the external relay output 9 will be activated	11900
External DO 10	If this logical output becomes true, the external relay output 10 will be activated	11901
External DO 11	If this logical output becomes true, the external relay output 11 will be activated	11902
External DO 12	If this logical output becomes true, the external relay output 12 will be activated	11903
External DO 13	If this logical output becomes true, the external relay output 13 will be activated	11904
External DO 14	If this logical output becomes true, the external relay output 14 will be activated	11905
External DO 15	If this logical output becomes true, the external relay output 15 will be activated	11906
External DO 16	If this logical output becomes true, the external relay output 16 will be activated	11907
External DO 17	If this logical output becomes true, the external relay output 17 will be activated	11390

Name	Function	ID
External DO 18	If this logical output becomes true, the external relay output 18 will be activated	11391
External DO 19	If this logical output becomes true, the external relay output 19 will be activated	11392
External DO 20	If this logical output becomes true, the external relay output 20 will be activated	11393
External DO 21	If this logical output becomes true, the external relay output 21 will be activated	11394
External DO 22	If this logical output becomes true, the external relay output 22 will be activated	11395
External DO 23	If this logical output becomes true, the external relay output 23 will be activated	11396
External DO 24	If this logical output becomes true, the external relay output 24 will be activated	11397
External DO 25	If this logical output becomes true, the external relay output 25 will be activated	11398
External DO 26	If this logical output becomes true, the external relay output 26 will be activated	11399
External DO 27	If this logical output becomes true, the external relay output 27 will be activated	11400
External DO 28	If this logical output becomes true, the external relay output 28 will be activated	11401
External DO 29	If this logical output becomes true, the external relay output 29 will be activated	11402
External DO 30	If this logical output becomes true, the external relay output 30 will be activated	11403
External DO 31	If this logical output becomes true, the external relay output 31 will be activated	11404
External DO 32	If this logical output becomes true, the external relay output 32 will be activated	11405

Relay		Application mode (parameter ↪ 3444)										
No.	Term.	None A01	GCB open A02	GCB A03	GCB / MCB A04	GCB / GGB A05	GCB / GGB / MCB A06	GCB / LSx A07 , GCB / GC A13	GCB / L-MCB A08	GCB / GGB / L-MCB A09	GCB / L-GGB A10	GCB / L-GGB / L-MCB A11
Internal relay outputs, board #1												
[R 01]	41/42	'Ready for operation'; additionally programmable with LogicsManager CAUTION! Only relay [R 01] has an inverse logic. The relay opens (all other relays close), if the logical output of the LogicsManager becomes TRUE.										

Relay		Application mode (parameter ↪ 3444)										
No.	Term.	None A01	GCB open A02	GCB A03	GCB / MCB A04	GCB / GGB A05	GCB / GGB / MCB A06	GCB / LSx A07, GCB / GC A13	GCB / L-MCB A08	GCB / GGB / L-MCB A09	GCB / L-GGB A10	GCB / L- GGB / L-MCB A11
[R 02]	43/46	LogicsManager; pre-assigned with 'Centralized alarm (horn)'										
[R 03]	44/46	LogicsManager; pre-assigned with 'Starter'										
[R 04]	45/46	LogicsManager; pre-assigned with 'Diesel: Fuel solenoid, Gas: Gas valve'										
[R 05]	47/48	LogicsManager; pre-assigned with 'Diesel: Preglow, Gas: Ignition'										
[R 06]	49/50	LogicsManager		Command: close GCB								
[R 07]	51/52	Logics- Manager		Command: open GCB								
[R 08]	53/54	LogicsManager			Command: close MCB		Logics- Manager		Command: close MCB		LogicsManager	
[R 09]	55/56	LogicsManager; pre-assigned with 'Mains decoupling'			Command: open MCB		Logics- Manager; pre- assigned with 'Mains decoupling'		Command: open MCB		LogicsManager; pre-assigned with 'Mains decoupling'	
[R 10]	57/60	LogicsManager; pre-assigned with 'Auxiliary services'			Command: close GGB			LogicsManager; pre-assigned with 'Auxiliary services'		Command: close GGB		LogicsManager; pre-assigned with 'Auxiliary services'
[R 11]	58/60	LogicsManager; pre-assigned with 'Alarm class A, B active'			Command: open GGB			LogicsManager; pre-assigned with 'Alarm class A, B active'		Command: open GGB		LogicsManager; pre-assigned with 'Alarm class A, B active'
[R 12]	59/60	LogicsManager; pre-assigned with 'Alarm class C, D, E, F active'										
[R 13]	121/122	LogicsManager; pre-assigned with 'Alarm class C, D, E, F active'										
[R 14]	123/124	LogicsManager; pre-assigned with 'Alarm class C, D, E, F active'										
[R 15]	125/126	LogicsManager; pre-assigned with 'Alarm class C, D, E, F active'										
[R 16]	127/128	LogicsManager; pre-assigned with 'Alarm class C, D, E, F active'										
[R 17]	129/130	LogicsManager; pre-assigned with 'Alarm class C, D, E, F active'										
[R 18]	131/132	LogicsManager; pre-assigned with 'Alarm class C, D, E, F active'										
[R 19]	133/134	LogicsManager; pre-assigned with 'Alarm class C, D, E, F active'										

Relay		Application mode (parameter ↩ 3444)										
No.	Term.	None A01	GCB open A02	GCB A03	GCB / MCB A04	GCB / GGB A05	GCB / GGB / MCB A06	GCB / LSx A07, GCB / GC A13	GCB / L-MCB A08	GCB / GGB / L-MCB A09	GCB / L-GGB A10	GCB / L- GGB / L-MCB A11
[R 20]	135/136	LogicsManager; pre-assigned with 'Alarm class C, D, E, F active'										
[R 21]	137/138	LogicsManager; pre-assigned with 'Alarm class C, D, E, F active'										
[R 22]	139/140	LogicsManager; pre-assigned with 'Alarm class C, D, E, F active'										

9.3.5 Factory Settings

LogicsManager's default definition

ID	Name	Function
4871	Inhibit cranking	(02.01 LM FALSE And True) And True
5580	PID1 ctrl.release	(False And True) And True
5593	PID2 ctrl.release	(False And True) And True
5679	PID3 ctrl.release	(False And True) And True
7794	Enable 2nd display brightness	(Not 04.64 Key activation And True) And True
7799	Enable front foil heater	(True And True) And True
7801	System update	(False And True) And True
7857	RP Full mode	(02.01 LM FALSE And True) And True
7858	RP Annunciator	(02.01 LM FALSE And True) And True
7859	RP Off mode	(02.01 LM FALSE And True) And True
7863	DPF: Inhibit regeneration	(02.01 LM FALSE And True) And True
7864	DPF: Force regeneration	(02.01 LM FALSE And True) And True
8120	Free alarm 1	(02.01 LM FALSE And True) And True
8124	Free alarm 2	(02.01 LM FALSE And True) And True
8128	Free alarm 3	(02.01 LM FALSE And True) And True
8132	Free alarm 4	(02.01 LM FALSE And True) And True
8136	Free alarm 5	(02.01 LM FALSE And True) And True
8140	Free alarm 6	(02.01 LM FALSE And True) And True
8144	Free alarm 7	(02.01 LM FALSE And True) And True
8148	Free alarm 8	(02.01 LM FALSE And True) And True
8154	Free alarm 9	(02.01 LM FALSE And True) And True
8158	Free alarm 10	(02.01 LM FALSE And True) And True
8165	Free alarm 11	(02.01 LM FALSE And True) And True

ID	Name	Function
8170	Free alarm 12	(02.01 LM FALSE And True) And True
8174	Free alarm 13	(02.01 LM FALSE And True) And True
8178	Free alarm 14	(02.01 LM FALSE And True) And True
8182	Free alarm 15	(02.01 LM FALSE And True) And True
8186	Free alarm 16	(02.01 LM FALSE And True) And True
8258	PV breaker closed	(02.01 LM FALSE And True) And True
8263	Gen.group1 breaker closed	(04.87 Min. one GCB closed And True) And True
8268	Gen.group2 breaker closed	(02.01 LM FALSE And True) And True
8928	Release PV regulation	(02.01 LM FALSE And True) And True
11978	2nd load control setpoint ramp	(False And 02.02 LM TRUE) And 02.02 LM TRUE
11986	LS interface Ethernet A	(02.01 LM FALSE And True) And True
11988	10.79 RTC Year	(02.01 LM FALSE And True) And True
12037	AVR Enable V(f)	(02.01 LM FALSE And True) And 86.97 LM: Release V-control
12110	Relay 2	(03.05 Horn And True) And True
12120	Start req. in AUTO	(09.02 Discrete input 2 Or False) Or 04.13 Remote request
12130	Relay 5	(03.04 Preglow / Ignition And True) And True
12140	Relay 6	(False And True) And True
12150	Relay 7	(False And True) And True
12160	Relay 8	(False And True) And True
12170	Relay 9	(False And True) And True
12180	Relay 10	(03.01 Auxiliary services And True) And True
12190	Stop req. in AUTO	(False And True) And True
12200	Inhibit emerg.run	(False And True) And True
12210	Undelay close GCB	(04.09 Emergency mode And True) And True
12220	Critical mode	(False And Not 05.08 Start fail) And Not 09.01 Discrete input 1
12230	Flag 1	(02.01 LM FALSE And True) And True
12231	Flag 17	(02.01 LM FALSE And True) And True
12233	Flag 18	(02.01 LM FALSE And True) And True
12235	Flag 19	(02.01 LM FALSE And True) And True
12237	Flag 20	(02.01 LM FALSE And True) And True
12240	Flag 2	(02.01 LM FALSE And True) And True
12241	Flag 21	(02.01 LM FALSE And True) And True
12243	Flag 22	(02.01 LM FALSE And True) And True
12245	Flag 23	(02.01 LM FALSE And True) And True
12247	Flag 24	(02.01 LM FALSE And True) And True
12250	Flag 3	(02.01 LM FALSE And True) And True
12251	Flag 25	(02.01 LM FALSE And True) And True
12253	Flag 26	(02.01 LM FALSE And True) And True

ID	Name	Function
12255	Flag 27	(02.01 LM FALSE And True) And True
12257	Flag 28	(02.01 LM FALSE And True) And True
12260	Flag 4	(02.01 LM FALSE And True) And True
12261	Flag 29	(02.01 LM FALSE And True) And True
12263	Flag 30	(02.01 LM FALSE And True) And True
12265	Flag 31	(02.01 LM FALSE And True) And True
12267	Flag 32	(02.01 LM FALSE And True) And True
12269	Setp. 4 load	(False And True) And True
12270	Flag 5	(02.01 LM FALSE And True) And True
12271	Operat. mode TEST	(False And True) And True
12280	Flag 6	(02.01 LM FALSE And True) And True
12290	Flag 7	(02.01 LM FALSE And True) And True
12300	Flag 8	(02.01 LM FALSE And True) And True
12310	Relay 3	(03.02 Starter And True) And True
12320	Relay 4	(03.28 Start/Gas And True) And True
12330	External DO 1	(False And True) And True
12331	External DO 17	(False And True) And True
12332	External DO 18	(False And True) And True
12333	External DO 19	(False And True) And True
12334	External DO 20	(False And True) And True
12335	External DO 21	(False And True) And True
12336	External DO 22	(False And True) And True
12337	External DO 23	(False And True) And True
12338	External DO 24	(False And True) And True
12339	External DO 25	(False And True) And True
12340	External DO 2	(False And True) And True
12341	External DO 26	(False And True) And True
12342	External DO 27	(False And True) And True
12343	External DO 28	(False And True) And True
12344	External DO 29	(False And True) And True
12345	External DO 30	(False And True) And True
12346	External DO 31	(False And True) And True
12347	External DO 32	(False And True) And True
12350	External DO 3	(False And True) And True
12360	External DO 4	(False And True) And True
12370	External DO 5	(False And True) And True
12380	External DO 6	(False And True) And True
12390	External DO 7	(False And True) And True

ID	Name	Function
12400	External DO 8	(False And True) And True
12410	External DO 9	(False And True) And True
12420	External DO 10	(False And True) And True
12430	External DO 11	(False And True) And True
12440	External DO 12	(False And True) And True
12450	External DO 13	(False And True) And True
12460	External DO 14	(False And True) And True
12470	External DO 15	(False And True) And True
12480	External DO 16	(False And True) And True
12490	Ext. acknowledge	(09.05 Discrete input 5 And True) Or 04.14 Remote acknowledge
12510	Operat. mode AUTO	(False And True) And True
12520	Operat. mode MAN	(False And True) And True
12530	Operat. mode STOP	(False And True) And True
12540	Start w/o load	(False And True) And True
12550	Constant idle run	(False And True) And True
12560	Relay 11	(01.08 Warning alarm And True) And True
12570	Auto idle mode	(False And True) And True
12580	Ready for op. OFF	(False And False) And True
12590	Relay 12	(01.09 Shutdown alarm And True) And True
12604	IOP Reserve power 2	(False And True) And True
12605	MOP Reserve power 2	(False And True) And True
12690	Relay 13	(False And True) And True
12700	Relay 14	(False And True) And True
12710	Relay 15	(False And True) And True
12720	Relay 16	(False And True) And True
12730	Relay 17	(False And True) And True
12740	Relay 18	(False And True) And True
12750	Relay 19	(False And True) And True
12760	Relay 20	(False And True) And True
12770	Relay 21	(False And True) And True
12780	Relay 22	(False And True) And True
12790	Transistor out 1	(False And True) And True
12800	Transistor out 2	(False And True) And True
12853	Disable load setpoint ramp	(02.01 LM FALSE And True) And True
12884	Lamp test	(02.01 LM FALSE And True) And True
12885	Bypass preglow time	(False And True) And True
12886	Open GCB immediately	(False And True) And True
12887	Enable GCB	(True And True) And True

ID	Name	Function
12900	Discrete f/P +	(False And True) And True
12901	Discrete f/P -	(False And True) And True
12902	Discrete V/PF +	(False And True) And True
12903	Discrete V/PF -	(False And True) And True
12904	Freq. droop act.	(08.17 Missing members Or 08.06 GCB fail to open) And True
12905	Volt. droop act.	(08.17 Missing members Or 08.06 GCB fail to open) And True
12906	Syn. mode CHECK	(False And True) And True
12907	Syn. mode PERMIS.	(False And True) And True
12908	Syn. mode RUN	(False And True) And True
12909	Release f-control	(True And True) And True
12910	Flag 9	(02.01 LM FALSE And True) And True
12911	Flag 10	(02.01 LM FALSE And True) And True
12912	Flag 11	(02.01 LM FALSE And True) And True
12913	Flag 12	(02.01 LM FALSE And True) And True
12914	Flag 13	(02.01 LM FALSE And True) And True
12915	Flag 14	(02.01 LM FALSE And True) And True
12916	Flag 15	(02.01 LM FALSE And True) And True
12917	Flag 16	(02.01 LM FALSE And True) And True
12918	Setpoint 2 freq.	(False And True) And True
12919	Setp. 2 load	(False And True) And True
12920	Setp. 2 voltage	(False And True) And True
12921	Setp.2 pwr.factor	(False And True) And True
12922	Ext. mns.decoupl.	(False And True) And True
12923	Enable MCB	(09.06 Discrete input 6 And Not 08.07 MCB fail to close) And Not 07.05 Mns.ph.rot. mismatch
12924	LDSS Priority 4	(02.01 LM FALSE And True) And True
12925	LDSS Priority 3	(02.01 LM FALSE And True) And True
12926	LDSS Priority 2	(02.01 LM FALSE And True) And True
12927	Segment no.4 act.	(02.01 LM FALSE And True) And True
12928	Segment no.3 act.	(02.01 LM FALSE And True) And True
12929	Segment no.2 act.	(02.01 LM FALSE And True) And True
12930	LD start stop	(False And True) And True
12931	Transition mode 1	(False And True) And True
12932	Transition mode 2	(False And True) And True
12936	Bypass min. Pgen.	(False And True) And True
12937	Run-up sync.	(False And True) And True
12938	Release V-control	(True And True) And True
12940	P control	(04.07 MCB closed And 04.06 GCB closed) And True

ID	Name	Function
12941	Q control	(04.07 MCB closed And 04.06 GCB closed) And True
12942	Enable mains decoupl.	(02.02 LM TRUE And True) And True
12947	Open GGB immediately	(False And True) And True
12948	Enable GGB	(Not 04.02 Operat. mode STOP And True) And True
12951	Firing speed detection	(02.34 Firing speed electr. Or 02.35 Firing speed rpm) And True
12970	MAN engine start	(False And True) And True
12971	MAN engine stop	(False And True) And True
12972	GGB open in MAN	(False And True) And True
12973	GGB close in MAN	(False And True) And True
12974	MCB open in MAN	(False And True) And True
12975	MCB close in MAN	(False And True) And True
12976	GCB open in MAN	(False And True) And True
12977	GCB close in MAN	(False And True) And True
12978	Lock keypad 1	(False And True) And True
12979	LSx command 1	(02.01 LM FALSE And True) And True
12980	LSx command 2	(02.01 LM FALSE And True) And True
12981	LSx command 3	(02.01 LM FALSE And True) And True
12982	LSx command 4	(02.01 LM FALSE And True) And True
12983	LSx command 5	(02.01 LM FALSE And True) And True
12984	LSx command 6	(02.01 LM FALSE And True) And True
12989	Speed detection	(02.36 Speed electr. Or 02.37 Speed rpm) And True
12990	2nd Frequency PID	(False And True) And True
12998	Setp. 3 load	(False And True) And True
12999	Release eng.mon.	(02.34 Firing speed electr. Or 02.35 Firing speed rpm) And 03.28 Start/Gas
15026	LDSS with predicted load	(False And True) And True
15146	Free derating	(02.01 LM FALSE And True) And True
15158	Release cyl.temp.	(02.01 LM FALSE And True) And True
15159	Disable mns.mon.	(False And True) And True
15160	Mains decoupl.MCB	(False And True) And True
15161	Inh.dead bus GCB	(False And True) And True
15164	ECU seq. B_IN_1	(False And True) And True
15165	ECU seq. B_IN_2	(False And True) And True

Table 161: Factory settings by ID: LogicsManager

Relay outputs

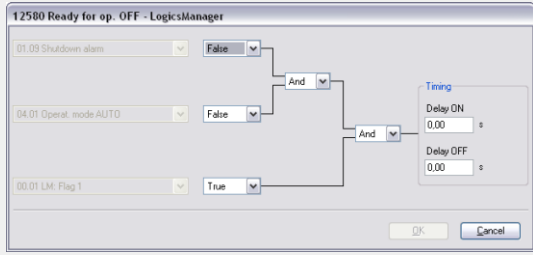
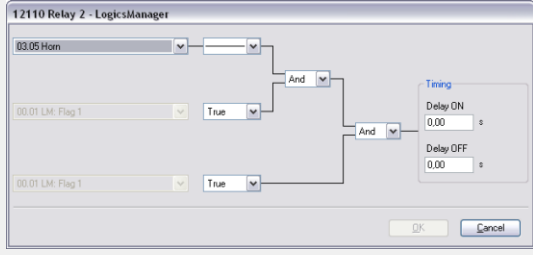
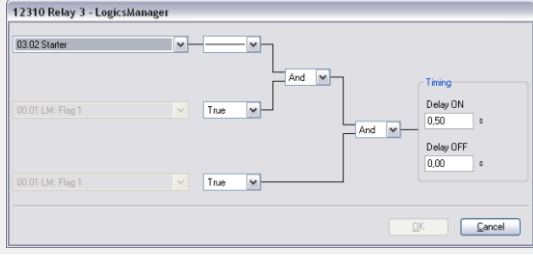
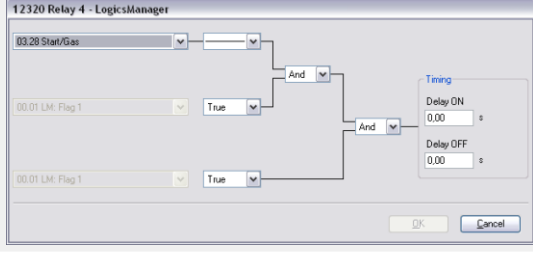
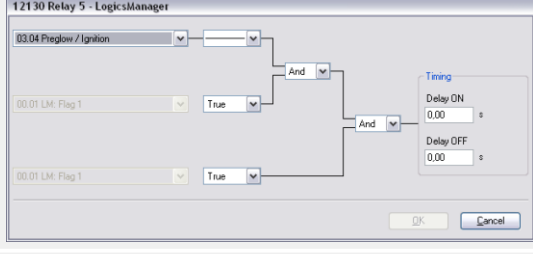
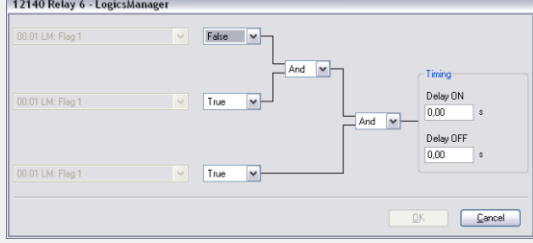
Simple (function)	Extended (configuration)	Result
<p>[99.01] Relay 1 [R01] - Ready for operation OFF</p> <p>Relay will be de-energized if unit is not ready for operation or the logics manager output is TRUE.</p> <p>Deactivated by default</p> <p>Note: This function is pre-configured and may be activated by passing through the command variables [01.09] Shutdown alarm or [04.01] Operating mode AUTO or [00.01] LM: Flag 1 ('-' instead of '0').</p> <p>The unit is only ready for operation after a start-up delay following the power supply connection.</p>		FALSE
<p>[99.02] Relay 2 [R02] - Centralized alarm (horn) / freely configurable</p> <p>Relay energizes if the internal condition "Horn" is TRUE</p>		dependent on Logics Command Variable [03.05]
<p>[99.03] Relay 3 [R03] - Starter / freely configurable</p> <p>Relay energizes if the internal condition "Starter" is TRUE</p>		dependent on Logics Command Variable [03.02]
<p>[99.04] Relay 4 [R04] - Start/Gas / freely configurable</p> <p>Relay energizes if the internal condition "Start/Gas" is TRUE to energize the start (Diesel) or gas (Gas) solenoid</p>		dependent on Logics Command Variable [03.28]
<p>[99.05] Relay 5 [R05] - Preglow/ Ignition / freely configurable</p> <p>Relay energizes if the internal condition "Preglow/Ignition" is TRUE to preglow the Diesel engine or enabling the ignition of the gas engine</p>		dependent on Logics Command Variable [03.04]
<p>[99.06] Relay 6 [R06] - Free / Command: close GCB</p> <p>In application mode</p> <p>A01 and A02 = freely configurable relay (unassigned)</p>		FALSE

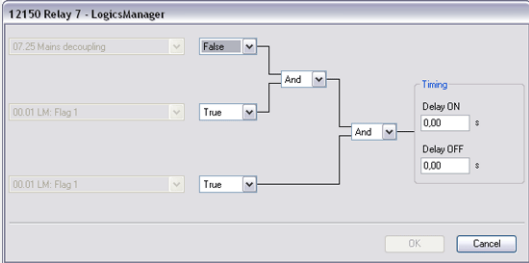
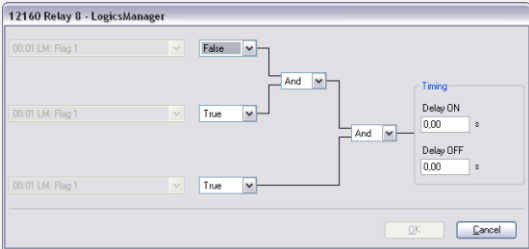
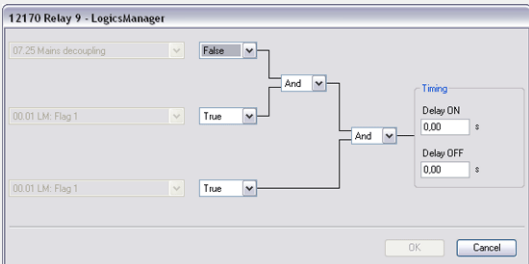
Simple (function)	Extended (configuration)	Result
<p>In application mode A03 to A13 "Command: close GCB"</p> <p>Deactivated by default</p>		
<p>[99.07] Relay 7 [R07] - Mains decoupling / freely configurable / Command: open GCB</p> <p>In application mode A01 pre-configured to mains decoupling. Relay energizes if the internal condition "Mains decoupling" is TRUE to decouple the genset from the mains.</p> <p>In application mode A02 to A13 "Command: open GCB"</p> <p>Deactivated by default</p>		<p>dependent on application mode and Logics Command Variable [07.25]</p>
<p>[99.08] Relay 8 [R08] - Free / Command: close MCB</p> <p>In application mode A01, A02, A03, A05, A07, A08, A09, A10 and A11 to A13 freely configurable relay (unassigned)</p> <p>In application mode A04 and A06 "Command: close MCB"</p> <p>Deactivated by default</p>		<p>FALSE</p>
<p>[99.09] Relay 9 [R09] - Mains decoupling / freely configurable / Command: open MCB</p> <p>In application mode A01, A02, A03, A05, A07, A08, A09, A10 and A11 to A13 pre-configured to mains decoupling. Relay energizes if the internal condition "Mains decoupling" is TRUE to decouple the genset from the mains.</p> <p>In application mode A04 and A06 "Command: open MCB"</p> <p>Deactivated by default</p>		<p>dependent on application mode and Logics Command Variable [07.25]</p>
<p>[99.10] Relay 10 [R10] - Auxiliary services / freely configurable</p> <p>In application mode A01, A02, A03, A04, A07, A08, A10 and A11 to A13 pre-configured to auxiliary services. Relay energizes if the internal condition "Aux. services" is TRUE to activate the auxiliary services (it energizes prior to an engine start and de-energizes with the engine stop)</p> <p>In application mode A05, A06 and A09 "Command: close GGB"</p>		<p>dependent on Logics Command Variable [03.01]</p>

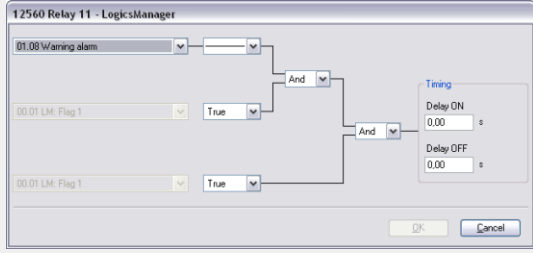
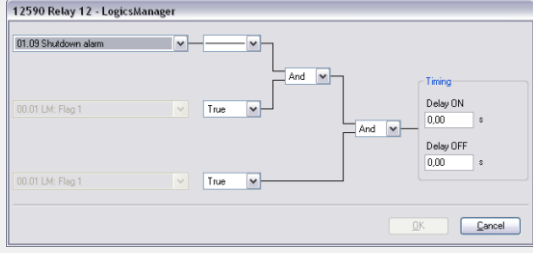
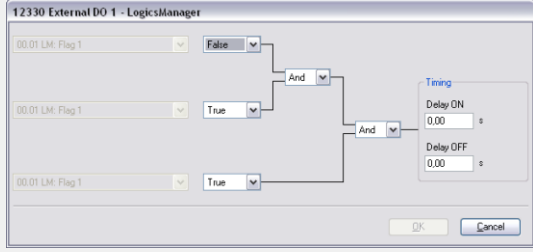
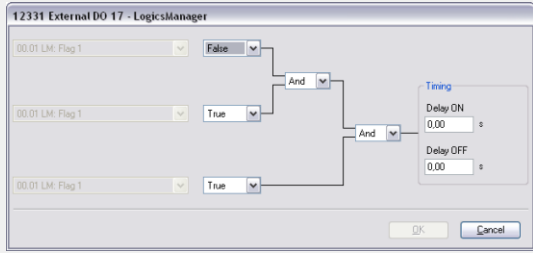
Simple (function)	Extended (configuration)	Result
<p>[99.11] Relay 11 [R11] - Warning alarm class active / freely configurable</p> <p>In application mode A01, A02, A03, A04, A07, A08, A10 and A11 to A13 pre-configured to alarm class A or B. Relay energizes if one of the alarm classes A or B is active</p> <p>In application mode A05, A06 and A09 "Command: open GGB"</p>		<p>dependent on Logics Command Variable [01.08]</p>
<p>[99.12] Relay 12 [R12] - Shutdown alarm class active / freely configurable</p> <p>Relay energizes if one of the alarm classes C, D, E or F is active</p>		<p>dependent on Logics Command Variable [01.09]</p>
<p>[98.xx] External discrete output {y} - {xx} = 01 to 32 ; {y} = 1 to 32</p> <p>Control of the external relay {y}, if this is connected</p> <p>Prepared for:</p> <p>Deactivated by default</p>		<p>FALSE</p>
<p>[98.xx] External discrete output {y} - Free (external expansion card, if connected; {xx} = 01 to 16 ; {y} = 17 to 32).</p> <p>Control of the external relay {y}, if this is connected</p> <p>Prepared for:</p> <p>Deactivated by default</p>		<p>FALSE</p>

Discrete inputs

Number	LM	ID	Alarm class		Pre-assigned to
DI 01	09.01	10900	F	freely configurable	EMERGENCY STOP
DI 02	09.02	10901	CONTROL	freely configurable	LogicsManager Start in AUTO
DI 03	09.03	10902	B	freely configurable	Low oil pressure
DI 04	09.04	10903	B	freely configurable	Coolant temperature
DI 05	09.05	10904	CONTROL	freely configurable	LogicsManager External acknowledgment
DI 06	09.06	10905	CONTROL	freely configurable	LogicsManager Enable MCB
DI 07	09.07	10906		fixed	Reply MCB
DI 08	09.08	10907		fixed	Reply GCB

Number	LM	ID	Alarm class		Pre-assigned to
DI 09	09.09	10908	B	freely configurable	unassigned
DI 10	09.10	10909	B	freely configurable	unassigned
DI 11	09.11	10910	B	freely configurable	unassigned
DI 12	09.12	10911	B	freely configurable	unassigned

DI	Alarm class		Pre-assigned to
13	B	freely configurable	unassigned
14	B	freely configurable	unassigned
15	B	freely configurable	unassigned
16	B	freely configurable	unassigned
17	B	freely configurable	unassigned
18	B	freely configurable	unassigned
19	B	freely configurable	unassigned
20	B	freely configurable	unassigned
21	B	freely configurable	unassigned
22	B	freely configurable	unassigned
23	B	freely configurable	unassigned

Table 162:

9.4 AnalogManager Reference

9.4.1 AnalogManager Overview

To enhance flexibility of programming the functions of the easYgen-3000XT series, an AnalogManager is used.

All analog values may be used as data sources for the analog outputs (refer to [↪ “4.4.2.5 Analog Outputs”](#)), the flexible limit monitoring (refer to [↪ “4.5.5 Flexible Limits”](#)), and the controller setpoints (refer to [↪ “4.4.4 Configure Controller”](#)).



- Every data source is indicated by a group number and a sub-number.
- Some values are percentage values and relate to reference values.

AnalogManager Variables

Groups 1 to 79 make available even more than the already arranged analog variables out of the easYgen system.

AnalogManager Results



Cascading: Use analog results

This analog **results** of an AnalogManager is available as AnalogManager input additionally. Like the other AnalogManager inputs they can be used as input signal for (further) AnalogManagers.

The groups 80.xx to 89.xx contain analog outputs (results) of function-related AnalogManagers.

The description/name of these analog variables starts always with 'AM ...'.

'Internal'/Fixed AnalogManager Values

The groups 90.xx to 99.xx contain analog outputs of fixed AnalogManagers.

The description/name of these analog variables starts always with 'AM ...'.

9.4.2 Data Sources AM

9.4.2.1 Group 01: Generator values

The percentage value is related on the following values:

- generator rated voltage
- system rated frequency
- generator rated current
- power factor:

Lagging: value [%] = (2 - PF) * 50%

e.g. PF = 0.8: value [%] = (2 - 0.8) * 50% = 60%

Leading: value [%] = PF * (-1) * 50%

e.g. PF = - 0.8: value [%] = (- 0.8) * (-1) * 50% = 40%

- generator rated active power
- generator rated reactive power
- generator rated active and generator rated reactive power

HMI Text	Note
01.01 Gen.volt.L-N [%]	Generator voltage wye average
01.02 Gen.volt.L1-N [%]	Generator voltage L1-N
01.03 Gen.volt.L2-N [%]	Generator voltage L2-N
01.04 Gen.volt.L3-N [%]	Generator voltage L3-N
01.05 Gen.volt.L-L [%]	Generator voltage delta average
01.06 Gen.volt.L1-L2 [%]	Generator voltage L1-L2

HMI Text	Note
01.07 Gen.volt.L2-L3 [%]	Generator voltage L2-L3
01.08 Gen.volt.L3-L1 [%]	Generator voltage L3-L1
01.09 Gen.frequency [%]	Generator frequency
01.10 Gen.freq.L1-L2 [%]	Generator frequency L1-L2
01.11 Gen.freq.L2-L3 [%]	Generator frequency L2-L3
01.12 Gen.freq.L3-L1 [%]	Generator frequency L3-L1
01.13 Gen.current [%]	Generator average current
01.14 Gen.current L1 [%]	Generator current L1
01.15 Gen.current L2 [%]	Generator current L2
01.16 Gen.current L3 [%]	Generator current L3
01.17 Gen.curr.max. L1 [%]	Dragged generator current L1
01.18 Gen.curr.max. L2 [%]	Dragged generator current L2
01.19 Gen.curr.max. L3 [%]	Dragged generator current L3
01.20 Gen. PF [%]	Generator power factor
01.21 Gen. PF L1 [%]	Generator power factor L1
01.22 Gen. PF L2 [%]	Generator power factor L2
01.23 Gen. PF L3 [%]	Generator power factor L3
01.24 Gen.act.power [%]	Total generator active power
01.25 Gen.act.pwr. L1 [%]	Generator active power L1-N
01.26 Gen.act.pwr. L2 [%]	Generator active power L2-N
01.27 Gen.act.pwr. L3 [%]	Generator active power L3-N
01.28 Gen.react.pwr. [%]	Total generator reactive power
01.29 Gen.react.pwr.L1 [%]	Generator reactive power L1-N
01.30 Gen.react.pwr.L2 [%]	Generator reactive power L2-N
01.31 Gen.react.pwr.L3 [%]	Generator reactive power L3-N
01.32 Gen.app.power [%]	Total generator apparent power
01.33 Gen.app.pwr. L1 [%]	Generator apparent power L1-N
01.34 Gen.app.pwr. L2 [%]	Generator apparent power L2-N
01.35 Gen.app.pwr. L3 [%]	Generator apparent power L3-N
01.51 Gen.volt.L-N [V]	Generator voltage wye average
01.52 Gen.volt.L1-N [V]	Generator voltage L1-N
01.53 Gen.volt.L2-N [V]	Generator voltage L2-N
01.54 Gen.volt.L3-N [V]	Generator voltage L3-N
01.55 Gen.volt.L-L [V]	Generator voltage delta average
01.56 Gen.volt.L1-L2 [V]	Generator voltage L1-L2
01.57 Gen.volt.L2-L3 [V]	Generator voltage L2-L3
01.58 Gen.volt.L3-L1 [V]	Generator voltage L3-L1
01.59 Gen.frequency [Hz]	Generator frequency

HMI Text	Note
01.60 Gen.freq.L1-L2 [Hz]	Generator frequency L1-L2
01.61 Gen.freq.L2-L3 [Hz]	Generator frequency L2-L3
01.62 Gen.freq.L3-L1 [Hz]	Generator frequency L3-L1
01.63 Gen.current [A]	Generator average current
01.64 Gen.current L1 [A]	Generator current L1
01.65 Gen.current L2 [A]	Generator current L2
01.66 Gen.current L3 [A]	Generator current L3
01.67 Gen.curr.max. L1 [A]	Dragged generator current L1
01.68 Gen.curr.max. L2 [A]	Dragged generator current L2
01.69 Gen.curr.max. L3 [A]	Dragged generator current L3
01.70 Gen. PF	Generator power factor
01.71 Gen. PF L1	Generator power factor L1
01.72 Gen. PF L2	Generator power factor L2
01.73 Gen. PF L3	Generator power factor L3
01.74 Gen.act.power [W]	Total Generator active power
01.75 Gen.act.pwr. L1 [W]	Generator active power L1-N
01.76 Gen.act.pwr. L2 [W]	Generator active power L2-N
01.77 Gen.act.pwr. L3 [W]	Generator active power L3-N
01.78 Gen.react.pwr. [var]	Total generator reactive power
01.79 Gen.react.pwr.L1[var]	Generator reactive power L1-N
01.80 Gen.react.pwr.L2[var]	Generator reactive power L2-N
01.81 Gen.react.pwr.L3[var]	Generator reactive power L3-N
01.82 Gen.app.power [VA]	Total generator apparent power
01.83 Gen.app.pwr. L1 [VA]	Generator apparent power L1-N
01.84 Gen.app.pwr. L2 [VA]	Generator apparent power L2-N
01.85 Gen.app.pwr. L3 [VA]	Generator apparent power L3-N
01.86 Number of pole slips	Actual number of pole slip events for the analog manager.
01.88 Gen.act.power [kW]	Total Generator active power in kW
01.89 Gen.react.pwr. [kvar]	Total generator reactive power in kvar
01.90 Gen.app.power [kVA]	Total generator apparent power in kVA

9.4.2.2 Group 02: Mains values

The percentage value is related on the following values:

- mains rated voltage
- system rated frequency
- mains rated current

- power factor:

Lagging: value [%] = (2 - PF) * 50%

e.g. PF = 0.8: value [%] = (2 - 0.8) * 50% = 60%

Leading: value [%] = PF * (-1) * 50%

e.g. PF = - 0.8: value [%] = (- 0.8) * (-1) * 50% = 40%

- mains rated active power
- mains rated reactive power
- mains rated active and mains rated reactive power

HMI Text	Note
02.01 Mains volt.L-N [%]	Mains voltage wye average
02.02 Mains volt.L1-N [%]	Mains voltage 1-N
02.03 Mains volt.L2-N [%]	Mains voltage 2-N
02.04 Mains volt.L3-N [%]	Mains voltage 3-N
02.05 Mains volt.L-L [%]	Mains voltage delta average
02.06 Mains volt.L1-L2 [%]	Mains voltage 1-2
02.07 Mains volt.L2-L3 [%]	Mains voltage 2-3
02.08 Mains volt.L3-L1 [%]	Mains voltage 3-1
02.09 Mains frequency [%]	Mains frequency
02.10 Mains freq.L1-L2 [%]	Mains frequency 1-2
02.11 Mains freq.L2-L3 [%]	Mains frequency 2-3
02.12 Mains freq.L3-L1 [%]	Mains frequency 3-1
02.13 Mains current [%]	Mains average current
02.14 Mains current L1 [%]	Mains current 1
02.15 Mains current L2 [%]	Mains current 2
02.16 Mains current L3 [%]	Mains current 3
02.17 Mns.curr.max.L1 [%]	Dragged mains current 1
02.18 Mns.curr.max.L2 [%]	Dragged mains current 2
02.19 Mns.curr.max.L3 [%]	Dragged mains current 3
02.20 Mains PF [%]	Mains power factor
02.21 Mains PF L1 [%]	Mains power factor 1
02.22 Mains PF L2 [%]	Mains power factor 2
02.23 Mains PF L3 [%]	Mains power factor 3
02.24 Mains act.power [%]	Total mains active power
02.25 Mns.act.pwr.L1 [%]	Mains power 1-N
02.26 Mns.act.pwr.L2 [%]	Mains power 2-N
02.27 Mns.act.pwr.L3 [%]	Mains power 3-N
02.28 Mns.react.pwr. [%]	Total mains reactive power

HMI Text	Note
02.29 Mns.react.pwr.L1 [%]	Mains reactive power 1-N
02.30 Mns.react.pwr.L2 [%]	Mains reactive power 2-N
02.31 Mns.react.pwr.L3 [%]	Mains reactive power 3-N
02.32 Mns.app.power [%]	Total mains apparent power
02.33 Mns.app.pwr.L1 [%]	Mains apparent power 1-N
02.34 Mns.app.pwr.L2 [%]	Mains apparent power 2-N
02.35 Mns.app.pwr.L3 [%]	Mains apparent power 3-N
02.36 Mns.ext.act.pwr.[%]	Mains external measured active power by AI
02.37 Mns.ext.react.pwr.[%]	Mains external measured reactive power by AI
02.38 Mains ext. PF [%]	Mains calculated Power Factor by AI
02.40 Mains freq.200ms [%]	Mains frequency average 200ms
02.51 Mains volt.L-N [V]	Mains voltage wye average
02.52 Mains volt.L1-N [V]	Mains voltage 1-N
02.53 Mains volt.L2-N [V]	Mains voltage 2-N
02.54 Mains volt.L3-N [V]	Mains voltage 3-N
02.55 Mains volt.L-L [V]	Mains voltage delta average
02.56 Mains volt.L1-L2 [V]	Mains voltage 1-2
02.57 Mains volt.L2-L3 [V]	Mains voltage 2-3
02.58 Mains volt.L3-L1 [V]	Mains voltage 3-1
02.59 Mains frequency [Hz]	Mains frequency
02.60 Mains freq.L1-L2 [Hz]	Mains frequency 1-2
02.61 Mains freq.L2-L3 [Hz]	Mains frequency 2-3
02.62 Mains freq.L3-L1 [Hz]	Mains frequency 3-1
02.63 Mains current [A]	Mains average current
02.64 Mains current L1 [A]	Mains current 1
02.65 Mains current L2 [A]	Mains current 2
02.66 Mains current L3 [A]	Mains current 3
02.67 Mns.curr.max.L1 [A]	Mains dragged current 1
02.68 Mns.curr.max.L2 [A]	Mains dragged current 2
02.69 Mns.curr.max.L3 [A]	Mains dragged current 3
02.70 Mains PF	Mains power factor
02.71 Mains PF L1	Mains power factor 1
02.72 Mains PF L2	Mains power factor 2
02.73 Mains PF L3	Mains power factor 3
02.74 Mains act.power [W]	Total mains active power
02.75 Mns.act.pwr. L1 [W]	Mains active power 1-N
02.76 Mns.act.pwr. L2 [W]	Mains active power 2-N
02.77 Mns.act.pwr. L3 [W]	Mains active power 3-N

HMI Text	Note
02.78 Mns.react.pwr. [var]	Total mains reactive power
02.79 Mns.react.pwr.L1[var]	Mains reactive power 1-N
02.80 Mns.react.pwr.L2[var]	Mains reactive power 2-N
02.81 Mns.react.pwr.L3[var]	Mains reactive power 3-N
02.82 Mns.app.power [VA]	Total mains apparent power
02.83 Mns.app.pwr.L1 [VA]	Mains apparent power 1-N
02.84 Mns.app.pwr.L2 [VA]	Mains apparent power 2-N
02.85 Mns.app.pwr.L3 [VA]	Mains apparent power 3-N
02.86 Mns.ext.act.pwr.[W]	Mains external measured active power by AI
02.87 Mns.ext.reac.pwr[var]	Mains external measured reactive power by AI
02.88 Mains ext. PF	Mains calculated Power Factor by AI
02.89 Mains settl.time [s]	Mains settling time
02.90 Mains freq.200ms [Hz]	Mains frequency average 200ms
02.91 Mains act.power [kW]	Total mains active power in kW
02.92 Mns.react.pwr. [kvar]	Total mains reactive power in kvar
02.93 Mns.app.power [kVA]	Total mains apparent power in kVA
02.94 Mns.ext.act.pwr.[kW]	Mains external measured active power by AI in kW

9.4.2.3 Group 03: Busbar 1 values

The percentage value is related on the following values:

- busbar 1 rated voltage
- system rated frequency

HMI Text	Note
03.01 Busb1 volt.L-L [%]	Busbar 1: voltage delta average [%]
03.02 Busb1 volt.L1-L2 [%]	Busbar 1: voltage L1-L2 [%]
03.03 Busb1 volt.L2-L3 [%]	Busbar 1: voltage L2-L3 [%]
03.04 Busb1 volt.L3-L1 [%]	Busbar 1: voltage L3-L1 [%]
03.05 Busb1 frequency [%]	Busbar 1: frequency [%]
03.06 Busb1 freq.L1-L2 [%]	Busbar 1: frequency L1-L2 [%]
03.07 Busb1 freq.L2-L3 [%]	Busbar 1: frequency L2-L3 [%]
03.08 Busb1 freq.L3-L1 [%]	Busbar 1: frequency L3-L1 [%]
03.09 Busb1 volt.L1-N [%]	Busbar 1: Voltage L1-N [%]
03.10 Busb1 volt.L2-N [%]	Busbar 1: Voltage L2-N [%]
03.11 Busb1 volt.L3-N [%]	Busbar 1: Voltage L3-N [%]
03.12 Busb1 volt.L-N [%]	Busbar 1: Voltage wye average [%]
03.51 Busb1 volt.L-L [V]	Busbar 1: voltage delta average [V]

HMI Text	Note
03.52 Busb1 volt.L1-L2 [V]	Busbar 1: voltage L1-L2 [V]
03.53 Busb1 volt.L2-L3 [V]	Busbar 1: voltage L2-L3 [V]
03.54 Busb1 volt.L3-L1 [V]	Busbar 1: voltage L3-L1 [V]
03.55 Busb1 frequency [Hz]	Busbar 1: frequency [Hz]
03.56 Busb1 freq.L1-L2 [Hz]	Busbar 1: frequency L1-L2 [Hz]
03.57 Busb1 freq.L2-L3 [Hz]	Busbar 1: Frequency L2-L3 [Hz]
03.58 Busb1 freq.L3-L1 [Hz]	Busbar 1: Frequency L3-L1 [Hz]
03.59 Busb1 volt.L1-N [V]	Busbar 1: Voltage L1-N [V]
03.60 Busb1 volt.L2-N [V]	Busbar 1: Voltage L2-N [V]
03.61 Busb1 volt.L3-N [V]	Busbar 1: Voltage L3-N [V]
03.62 Busb1 volt.L-N [V]	Busbar 1: Voltage wye average [V]
03.63 Phase Busb1-Gen [°]	Phase angle between busbar 1 and generator (Phase L1)
03.64 Phase Mains-Busb1 [°]	Phase angle between mains and busbar 1 (Phase L1)

9.4.2.4 Group 05: Controller setpoints

The percentage value is related on the following values:

- generator rated voltage
- system rated frequency
- generator rated current
- power factor 1
- generator rated active power
- generator rated reactive power
- generator rated active and generator rated reactive power

HMI Text	Note
05.01 Internal f setp1 [%]	Internal frequency setpoint 1
05.02 Internal f setp2 [%]	Internal frequency setpoint 2
05.03 Interface f setp [%]	Interface frequency setpoint
05.04 Internal P setp1 [%]	Internal power setpoint 1
05.05 Internal P setp2 [%]	Internal power setpoint 2
05.06 Interface P setp [%]	Interface power setpoint
05.07 Internal v setp1 [%]	Internal voltage setpoint 1
05.08 Internal v setp2 [%]	Internal voltage setpoint 2
05.09 Interface v setp [%]	Interface voltage setpoint
05.10 Intern. PF setp1 [%]	Internal power factor setpoint 1
05.11 Intern. PF setp2 [%]	Internal power factor setpoint 2

HMI Text	Note
05.12 Interface PF sp [%]	Interface power factor setpoint
05.13 Discrete f +/- [%]	Digital poti frequency
05.14 Discrete P +/- [%]	Digital poti power
05.15 Discrete v +/- [%]	Digital poti voltage
05.16 Discrete PF +/- [%]	Digital poti power factor
05.17 Used f setp. [%]	Used frequency setpoint
05.18 Used f setp.ramp [%]	Used frequency setpoint ramp
05.19 Used P setp. [%]	Used power setpoint
05.20 Used P setp.ramp [%]	Used power setpoint ramp
05.21 Used v setp. [%]	Used voltage setpoint
05.22 Used v setp.ramp [%]	Used voltage setpoint ramp
05.23 Used PF setp [%]	Used power factor setpoint
05.24 Used PF sp ramp [%]	Used power factor setpoint ramp
05.28 P derating(f) [%]	Generator active power derating dependent on mains frequency, value of reduction
05.29 PF characteristic [%]	Power factor corresponding to characteristic
05.30 Internal P setp3 [%]	Internal power setpoint 3
05.31 Int. kvar setp1 [%]	Internal kvar setpoint 1
05.32 Int. kvar setp2 [%]	Internal kvar setpoint 2
05.33 Interf. kvar sp [%]	Interface kvar setpoint
05.34 Internal P setp4 [%]	Internal power setpoint 4
05.35 F/P control setp [%]	F/P controller setpoint
05.36 V/Q control setp [%]	V/Q controller setpoint
05.37 Manual f setp. [%]	Manual setpoint frequency
05.38 Manual P setp. [%]	Manual setpoint real power
05.39 Manual V setp. [%]	Manual setpoint voltage
05.40 Manual PF setp. [%]	Manual setpoint power factor
05.41 Used Q setp. [%]	Used kvar setpoint
05.42 Q setp. ramp [%]	Used kvar setpoint ramp
05.43 QV reference [%]	Reactive power characteristic QV
05.44 QP reference [%]	Reactive power characteristic QP
05.45 QV lim.reference [%]	Reactive power characteristic QV limit
05.46 VQ0 reference	Reactive power characteristic reference VQ0
05.47 Interface QP offset	Offset to Q/P characteristic curve, received by interface
05.48 P uprating(f) [%]	P uprating (F)
05.51 Internal f setp1 [Hz]	Internal frequency setpoint 1
05.52 Internal f setp2 [Hz]	Internal frequency setpoint 2
05.53 Interface f setp [Hz]	Interface frequency setpoint
05.54 Internal P setp1 [kW]	Internal power setpoint 1

HMI Text	Note
05.55 Internal P setp2 [kW]	Internal power setpoint 2
05.56 Interface P setp [kW]	Interface power setpoint
05.57 Internal v setp1 [V]	Internal voltage setpoint 1
05.58 Internal v setp2 [V]	Internal voltage setpoint 2
05.59 Interface v setp [V]	Interface voltage setpoint
05.63 Discrete f +/- [Hz]	Digital poti frequency
05.64 Discrete P +/- [kW]	Digital poti power
05.65 Discrete v +/- [V]	Digital poti voltage
05.67 Used f setp. [Hz]	Used frequency setpoint
05.68 Used f setp.ramp [Hz]	Used frequency setpoint ramp
05.69 Used P setp. [kW]	Used power setpoint
05.70 Used P setp.ramp [kW]	Used power setpoint ramp
05.71 Used v setp. [V]	Used voltage setpoint
05.72 Used v setp.ramp [V]	Used voltage setpoint ramp
05.75 Int. PID1 setpoint	Internal PID 1 setpoint
05.76 Int. PID2 setpoint	Internal PID 2 setpoint
05.77 Int. PID3 setpoint	Internal PID 3 setpoint
05.80 Internal P setp3 [kW]	Internal power setpoint 3
05.81 Int.kvar setp1 [kvar]	Internal kvar setpoint 1
05.82 Int.kvar setp2 [kvar]	Internal kvar setpoint 2
05.83 Interf.kvar sp [kvar]	Interface kvar setpoint
05.84 Internal P setp4 [kW]	Internal power setpoint 4
05.87 Manual f setp. [Hz]	Manual setpoint frequency
05.88 Manual P setp. [kW]	Manual setpoint real power
05.89 Manual V setp. [V]	Manual setpoint voltage
05.91 Used Q setp. [kvar]	Used kvar setpoint
05.92 Q setp. ramp [kvar]	Used kvar setpoint ramp
05.93 QV reference [kvar]	Reactive power charateristic QV
05.94 QP reference [kvar]	Reactive power charateristic QP
05.95 QV limit ref.[kvar]	Reactive power charateristic QV limit
05.99 GC P setpoint [kW]	GC P setpoint

9.4.2.5 Group 06: DC analog inputs

HMI Text	Note
06.01 Analog input 1	Analog input 1
06.02 Analog input 2	Analog input 2
06.03 Analog input 3	Analog input 3

HMI Text	Note
06.04 Analog input 4	Analog input 4
06.05 Analog input 5	Analog input 5
06.06 Analog input 6	Analog input 6
06.07 Analog input 7	Analog input 7
06.08 Analog input 8	Analog input 8
06.09 Analog input 9	Analog input 9
06.10 Analog input 10	Analog input 10

9.4.2.6 Group 07: J1939 values 1

The leading number is the SPN number of the value.

HMI Text	Note
07.01 52:Eng.Interc.Temp.	52: Engine Intercooler Temperature
07.02 91:Accel.Pedal Pos.1	91: Accelerator Pedal Position 1
07.03 92:Load at Speed	92: Load At Current Speed
07.04 94:Fuel Deliv.Press.	94: Fuel Delivery Pressure
07.05 95:Fuel Filt.Diff.Pr.	95: Fuel Filter Differential Pressure
07.06 98:Engine Oil Level	98: Engine Oil Level
07.07 100:Engine Oil Press.	100: Engine Oil Pressure
07.08 101:Crankcase Press.	101: Crankcase Pressure
07.09 102:Int.Manif.1 Pr.	102: Intake Manifold 1 Pressure
07.10 105:Int.Manif.1 Temp.	105: Intake Manifold 1 Temperature
07.11 106:Air Intake Press.	106: Turbo Air Inlet Pressure
07.12 107:Air Filt1 Diff.Pr	107: Air Filter 1 Differential Pressure
07.13 108:Barometric Press.	108: Barometric Pressure
07.14 109:Coolant Pressure	109: Coolant Pressure
07.15 110:Eng.Coolant Temp.	110: Engine Coolant Temperature
07.16 111:Coolant Level	111: Coolant Level
07.17 127:Transm.Oil Press.	127: Transmission Oil Pressure
07.18 157:Inj.Met.Rail1 Pr.	157: Injector Metering Rail 1 Pressure
07.19 171:Ambient Air Temp.	171: Ambient Air Temperature
07.20 172:Air Intake Temp.	172: Air Inlet Temperature
07.21 173:Exhaust Gas Temp.	173: Exhaust Gas Temperature
07.22 174:Fuel Temp. 1	174: Fuel Temperature 1
07.23 175:Oil Temperature 1	175: Engine Oil Temperature 1
07.24 176:Turbo Oil Temp.	176: Turbo Oil Temperature
07.25 177:Transm.Oil Temp.1	177: Transmission Oil Temperature 1
07.26 183:Fuel Rate	183: Fuel Rate

9 Appendix

9.4.2.6 Group 07: J1939 values 1

HMI Text	Note
07.27 190:Engine Speed	190: Engine Speed
07.28 441:Auxiliary Temp.1	441: Auxiliary Temperature 1
07.29 442:Auxiliary Temp.2	442: Auxiliary Temperature 2
07.30 513:Actual Eng.Torque	513: Actual Engine Torque
07.31 1122:Altern.Bear.1 T	1122: Alternator Bearing 1 Temperature
07.32 1123:Altern.Bear.2 T	1123: Alternator Bearing 2 Temperature
07.33 1124:Altern.Wind.1 T	1124: Alternator Winding 1 Temperature
07.34 1125:Altern.Wind.2 T	1125: Alternator Winding 2 Temperature
07.35 1126:Altern.Wind.3 T	1126: Alternator Winding 3 Temperature
07.36 1131:Int.Manif.2 Temp	1131: Intake Manifold 2 Temperature
07.37 1132:Int.Manif.3 Temp	1132: Intake Manifold 3 Temperature
07.38 1133:Int.Manif.4 Temp	1133: Intake Manifold 4 Temperature
07.39 1134:Cooler Therm.Op.	1134: Engine Charge Air Cooler Thermostat Opening
07.40 1135:Oil Temp. 2	1135: Engine Oil Temperature 2
07.41 1136:ECU Temperature	1136: Engine ECU Temperature
07.42 1137:Exh.Gas P.1 Temp	1137: Exhaust Gas Port 1 Temperature
07.43 1138:Exh.Gas P.2 Temp	1138: Exhaust Gas Port 2 Temperature
07.44 1139:Exh.Gas P.3 Temp	1139: Exhaust Gas Port 3 Temperature
07.45 1140:Exh.Gas P.4 Temp	1140: Exhaust Gas Port 4 Temperature
07.46 1141:Exh.Gas P.5 Temp	1141: Exhaust Gas Port 5 Temperature
07.47 1142:Exh.Gas P.6 Temp	1142: Exhaust Gas Port 6 Temperature
07.48 1143:Exh.Gas P.7 Temp	1143: Exhaust Gas Port 7 Temperature
07.49 1144:Exh.Gas P.8 Temp	1144: Exhaust Gas Port 8 Temperature
07.50 1145:Exh.Gas P.9 Temp	1145: Exhaust Gas Port 9 Temperature
07.51 1146:Exh.Gas P.10 T	1146: Exhaust Gas Port 10 Temperature
07.52 1147:Exh.Gas P.11 T	1147: Exhaust Gas Port 11 Temperature
07.53 1148:Exh.Gas P.12 T	1148: Exhaust Gas Port 12 Temperature
07.54 1149:Exh.Gas P.13 T	1149: Exhaust Gas Port 13 Temperature
07.55 1150:Exh.Gas P.14 T	1150: Exhaust Gas Port 14 Temperature
07.56 1151:Exh.Gas P.15 T	1151: Exhaust Gas Port 15 Temperature
07.57 1152:Exh.Gas P.16 T	1152: Exhaust Gas Port 16 Temperature
07.58 1153:Exh.Gas P.17 T	1153: Exhaust Gas Port 17 Temperature
07.59 1154:Exh.Gas P.18 T	1154: Exhaust Gas Port 18 Temperature
07.60 1155:Exh.Gas P.19 T	1155: Exhaust Gas Port 19 Temperature
07.61 1156:Exh.Gas P.20 T	1156: Exhaust Gas Port 20 Temperature
07.62 1157:Main Bear.1 Temp	1157: Main Bearing 1 Temperature
07.63 1158:Main Bear.2 Temp	1158: Main Bearing 2 Temperature
07.64 1159:Main Bear.3 Temp	1159: Main Bearing 3 Temperature

HMI Text	Note
07.65 1160:Main Bear.4 Temp	1160: Main Bearing 4 Temperature
07.66 1161:Main Bear.5 Temp	1161: Main Bearing 5 Temperature
07.67 1162:Main Bear.6 Temp	1162: Main Bearing 6 Temperature
07.68 1163:Main Bear.7 Temp	1163: Main Bearing 7 Temperature
07.69 1164:Main Bear.8 Temp	1164: Main Bearing 8 Temperature
07.70 1165:Main Bear.9 Temp	1165: Main Bearing 9 Temperature
07.71 1166:Main Bear.10 T	1166: Main Bearing 10 Temperature
07.72 1167:Main Bear.11 T	1167: Main Bearing 11 Temperature
07.73 1172:Tb1 Compr.Int.T	1172: Turbocharger 1 Compressor Intake Temperature
07.74 1173:Tb2 Compr.Int.T	1173: Turbocharger 2 Compressor Intake Temperature
07.75 1174:Tb3 Compr.Int.T	1174: Turbocharger 3 Compressor Intake Temperature
07.76 1175:Tb4 Compr.Int.T	1175: Turbocharger 4 Compressor Intake Temperature
07.77 1176:Tb1 Compr.Int.Pr	1176: Turbocharger 1 Compressor Intake Pressure
07.78 1177:Tb2 Compr.Int.Pr	1177: Turbocharger 2 Compressor Intake Pressure
07.79 1178:Tb3 Compr.Int.Pr	1178: Turbocharger 3 Compressor Intake Pressure
07.80 1179:Tb4 Compr.Int.Pr	1179: Turbocharger 4 Compressor Intake Pressure
07.81 1180:Turbo1 Int.Temp	1180: Turbocharger 1 Intake Temperature
07.82 1181:Turbo2 Int.Temp	1181: Turbocharger 2 Intake Temperature
07.83 1182:Turbo3 Int.Temp	1182: Turbocharger 3 Intake Temperature
07.84 1183:Turbo4 Int.Temp	1183: Turbocharger 4 Intake Temperature
07.85 1184:Turbo1 Outl.Temp	1184: Turbocharger 1 Outlet Temperature
07.86 1185:Turbo2 Outl.Temp	1185: Turbocharger 2 Outlet Temperature
07.87 1186:Turbo3 Outl.Temp	1186: Turbocharger 3 Outlet Temperature
07.88 1187:Turbo4 Outl.Temp	1187: Turbocharger 4 Outlet Temperature
07.89 1203:Aux.Coolant Pr.	1203: Engine Auxiliary Coolant Pressure
07.90 1208:Pre-filt.Oil Pr.	1208: Pre-filter Oil Pressure
07.91 1212:Aux.Coolant Temp	1212: Engine Auxiliary Coolant Temperature
07.92 1382:Fuel Filt.DiffPr	1382: Fuel Filter Differential Pressure
07.93 1800:Battery 1 Temp.	1800: Battery 1 Temperature
07.94 1801:Battery 2 Temp.	1801: Battery 2 Temperature
07.95 1802:Int.Manif.5 Temp	1802: Intake Manifold 5 Temperature
07.96 1803:Int.Manif.6 Temp	1803: Intake Manifold 6 Temperature
07.97 2433:Right Exh.Gas T	2433: Right Exhaust Gas Temperature
07.98 2434:Left Exh.Gas T	2434: Left Exhaust Gas Temperature
07.99 2629:Tb1 Compr.Outl.T	2629: Turbocharger 1 Compressor Outlet Temperature

9.4.2.7 Group 08: External analog inputs

HMI Text	Note
08.01 Ext. analog input 1	External analog input 1
08.02 Ext. analog input 2	External analog input 2
08.03 Ext. analog input 3	External analog input 3
08.04 Ext. analog input 4	External analog input 4
08.05 Ext. analog input 5	External analog input 5
08.06 Ext. analog input 6	External analog input 6
08.07 Ext. analog input 7	External analog input 7
08.08 Ext. analog input 8	External analog input 8
08.09 Ext. analog input 9	External analog input 9
08.10 Ext. analog input 10	External analog input 10
08.11 Ext. analog input 11	External analog input 11
08.12 Ext. analog input 12	External analog input 12
08.13 Ext. analog input 13	External analog input 13
08.14 Ext. analog input 14	External analog input 14
08.15 Ext. analog input 15	External analog input 15
08.16 Ext. analog input 16	External analog input 16

9.4.2.8 Group 09: J1939 values 2

The leading number is the SPN number of the value.

HMI Text	Note
09.01 3644:Derate Request	3644: Engine Derate Request
09.02 158:Keysw.Batt.Pot.	158: Keyswitch Battery Potential
09.03 4151:Exh.Gas T Avr.	4151: Exhaust Gas Temperature average
09.04 4153:Exh.Gas T Avr.B1	4153: Exhaust Gas Temperature average Bank 1
09.05 4152:Exh.Gas T Avr.B2	4152: Exhaust Gas Temperature average Bank 2
09.06 ECU seq.A_OUT_1	ECU sequencer analog output 1
09.07 ECU seq.A_OUT_2	ECU sequencer analog output 2
09.08 1761:Aft1Exh.Tank1Lev	1761: Aftertreatment 1 Diesel Exhaust Fluid Tank 1 Level (At Scania: Urea level)
09.09 3031:Aft1 Exh.Tank1 T	3031: Aftertreatment 1 Diesel Exhaust Fluid Tank 1 Temperature
09.10 4367:Aft1Exh.Tank2Lev	4367: Aftertreatment 1 Diesel Exhaust Fluid Tank 2 Level
09.11 4368:Aft.1Exh.Tank2 T	4368: Aftertreatment 1 Diesel Exhaust Fluid Tank 2 Temperature
09.12 250: Total fuel used	250: Engine Total Fuel Used
09.13 247:Total Eng. Hours	247: Engine hours
09.14 96:Fuel level 1	96: Fuel level 1
09.15 38:Fuel level 2	38: Fuel level 2
09.16 3719: DPF 1 Soot load	3719: Diesel Particulate Filter 1 Soot Load Percent
09.17 3720: DPF 1 Ash load	3720: Diesel Particulate Filter 1 Ash Load Percent

HMI Text	Note
09.18 3251: DPF Diff. P	3251: Aftertreatment 1 Diesel Particulate Filter Differential Pressure
09.19 T left to torque red.	(Only for Volvo EMS2) Time left to torque reduction.
09.20 T left sev.torq.red.	(Only for Volvo EMS2) Time left to severe torque reduction
09.21 Number EIO activation	(Only for Volvo EMS2) Number of EIO activation (EIO: Emergency inducement override)
09.22 Accumulated EIO time	(Only for Volvo EMS2) Accumulated EIO time
09.23 Time left EIO operat.	(Only for Volvo EMS2) Time left EIO operation
09.24 3721:DPF1 time s.reg.	3721: Diesel Particulate Filter 1 Time Since Last Active Regeneration
09.25 5466:DPF1 soot thresh	5466: Aftertreatment 1 Diesel Particulate Filter Soot Load Regeneration Threshold
09.26 DPF regen.countd.time	(Only for Scania S8) DPF Regeneration Countdown Timer
09.27 HC evap.progr. timer	(Only for Scania S8) HC Evaporation Progress Countdown Timer
09.28 HC evap. start timer	(Only for Scania S8) HC Evaporation Action Countdown Timer
09.29 Time to torque limit.	(Only for Scania S8) Time to torque limiting (Note: value 251 means "No Pending Torque Limit")
09.30 3380:Excitation volt.	SPN 3380 Generator Excitation Field Voltage
09.31 3381:Excitation curr.	SPN 3381 Generator Excitation Field Current
09.32 3216: At1 Intake NOx	SPN 3216 Aftertreatment 1 Intake NOx [ppm]
09.33 3226: At1 Outlet NOx	SPN 3226 Aftertreatment 1 Outlet NOx [ppm]
09.34 4992: Charger 1 volt.	SPN 4992 Battery Charger 1 Output Voltage [V]
09.35 4993: Charger 1 curr.	SPN 4993 Battery Charger 1 Output Current [A]
09.36 Total aftertr.reagent	(Only for Volvo EMS) total Aftertreatment reagent (SCR, DEF, Adblue, urea) used for live of vehicle.
09.37 1117:Des.rated exh.O2	SPN 1117 Engine Desired Rated Exhaust Oxygen [%]
09.38 1118: Desired exh. O2	SPN 1118 Engine Desired Exhaust Oxygen [%]
09.39 1119: Actual exh. O2	SPN 1119 Engine Actual Exhaust Oxygen [%]
09.40 1695: O2 sens.fueling	SPN 1695 Engine Exhaust O2 Sensor Fueling Correction [%]
09.41 1765: Req.valve1 pos.	SPN 1765 Engine Requested Fuel Valve 1 Position [%]
09.42 1127:Tb1 boost press.	SPN 1127 Engine Turbocharger 1 Boost Pressure [kPa]
09.43 51: Throttle V1 pos.1	SPN 51 Engine Throttle Valve 1 Position 1 [%]
09.44 4765:Aft.Ox.Cat.Int.T	SPN 4765 Aftertreatment 1 Diesel Oxidation Catalyst Intake Gas Temperature [°C]
09.45 4766:Aft.Ox.Cat.Out.T	SPN 4766 Aftertreatment 1 Diesel Oxidation Catalyst outlet Gas Temperature [°C]

HMI Text	Note
09.46 ADEC ECU7 Fault code	Fault code for mtu ADEC ECU 7 (Fault roll)
09.47 3517:Aft1Exh.Tank L2	SPN 3517: Aftertreatment 1 Diesel Exhaust Fluid Tank 1 Level 2 [m]

9.4.2.9 Group 10: Internal values

HMI Text	Note
10.01 ZERO	Zero
10.02 ONE	One
10.04 Battery voltage [%]	Battery voltage (percentage value related on battery voltage 24V)
10.06 Calc.ground curr.[%]	Calculated ground current (percentage value related on generator rated current)
10.07 Meas.ground curr.[%]	Direct measured ground current (percentage value related on generator rated current)
10.08 AM PID1 bias	Free PID 1 analog output (PID1 bias)
10.09 AM PID2 bias	Free PID 2 analog output (PID2 bias)
10.10 AM PID3 bias	Free PID 3 analog output (PID3 bias)
10.11 System nominal P [%]	Active nominal power in system (percentage value related on system rated active power index 1825)
10.12 System real P [%]	Total real power in system (percentage value related on system rated active power index 1825)
10.13 System.res.real P [%]	Reserve real power in system (percentage value related on system rated active power index 1825)
10.39 PV load ref. [%]	PV load reference (PV set-point value 0% - 100%)
10.40 Generator load [%]	Generator load from the generators with closed GCB (same like value of index 237). Calculated by "active power in system" / "rated active power in system"
10.48 Gen.react.load [%]	Generator reactive load from the generators with closed GCB [%]
10.49 PV power setp. [%]	PV calculated active power setpoint
10.54 Battery voltage [V]	Battery voltage
10.56 Calc.ground curr.[A]	Calculated ground current
10.57 Meas.ground curr.[A]	Direct measured ground current
10.61 System nominal P [W]	Active nominal power in system [W]
10.62 System real P [W]	Total real power in system [W]
10.63 System.res.real P[W]	Reserve real power in system [W]
10.64 Act.power LSx [W]	Active power LSx (Active mains power in own segment)
10.65 React.power LSx [var]	Reactive power LSx (Reactive mains power in own segment)
10.66 Syst.react.pwr.[var]	Total reactive power in system [var]
10.67 Syst.A pwr. LSx [kW]	System A active power LSx Note: The value comes from the LSx (Node-ID33).

HMI Text	Note
	(Usable in dedicated LSx modes: GCB/L-MCB, GCB/GGB/L-MCB, GCB/L-GGBMCB, GCB/L-GGB/L-MCB where this LSx is connected with System A on mains)
10.68 Syst.A pwr.LSx [kvar]	System A reactive power LSx Note: The value comes from the LSx (Node-ID33). (Usable in dedicated LSx modes: GCB/L-MCB, GCB/GGB/L-MCB, GCB/L-GGBMCB, GCB/L-GGB/L-MCB where this LSx is connected with System A on mains)
10.70 LSx freq.L-L [Hz]	LSx frequency L-L Mains frequency of the LSx with the smallest device number OR frequency of the LSx with a close wish to the own segment.
10.71 LSx volt.L-L [V]	LSx voltage L-L Mains delta voltage of the LSx with the smallest device number
10.72 LSx volt.L-N [V]	LSx voltage L-N Mains wye voltage of the LSx with the smallest device number
10.73 Average load 1 [kW]	Average load 1
10.74 Average load 2 [kW]	Average load 2
10.75 Average load 3 [kW]	Average load 3
10.76 Average load 4 [kW]	Average load 4
10.77 Average load 5 [kW]	Average load 5
10.78 Average load sum [kW]	Average load sum
10.79 RTC Year	RTC Year
10.80 RTC Month	RTC Month
10.81 RTC Day	RTC Day
10.82 RTC Hour	RTC Hour
10.83 RTC Minute	RTC Minute
10.84 RTC Second	RTC Second
10.85 RTC Weekday	RTC Weekday
10.90 Generator load [kW]	Generator load from the generators with closed GCB [kW]
10.98 Gen.react.load [kvar]	Generator reactive load from the generators with closed GCB [kvar]
10.99 PV power setp. [kW]	PV calculated active power setpoint

9.4.2.10 Group 11: Engine values

HMI Text	Note
11.01 Engine speed [%]	Engine speed (unfiltered percentage value related on engine rated speed)
11.02 Voltage bias [%]	Biasing Voltage/P reactive
11.03 Speed bias [%]	Biasing Frequency/P active
11.04 Analog input D+ [%]	Analog input D+ (percentage value related on battery voltage 24V)

HMI Text	Note
11.51 Engine speed [rpm]	Engine speed (unfiltered)
11.54 Analog input D+ [V]	Analog input D+
11.55 Eng.oper.hours [h]	Engine operating hours
11.56 Cyl.temp.bank 1 [°C]	Average cylinder temperature bank 1
11.57 Cyl.temp.bank 2 [°C]	Average cylinder temperature bank 2
11.58 Period of use [h]	Period of use hours
11.59 Cooldown time [s]	Cooldown time
11.60 Preglow time [s]	Preglow time
11.61 Eng. monit. delay [s]	Engine monitoring delay time
11.62 Auxil.serv.prerun [s]	Auxiliary services prerun time
11.63 Auxil.serv.postrun [s]	Auxiliary services postrun time
11.64 Stop engine [s]	Stop time of the engine
11.66 Number of starts	Number of starts

9.4.2.11 Group 13: Constants

HMI Text	Note
13.01 Free constant 1	Free constant 1
13.02 Free constant 2	Free constant 2
13.03 Free constant 3	Free constant 3
13.04 Free constant 4	Free constant 4
13.05 Free constant 5	Free constant 5
13.06 Free constant 6	Free constant 6
13.07 Free constant 7	Free constant 7
13.08 Free constant 8	Free constant 8
13.09 Free constant 9	Free constant 9
13.10 Free constant 10	Free constant 10
13.11 Free constant 11	Free constant 11
13.12 Free constant 12	Free constant 12
13.13 Free constant 13	Free constant 13
13.14 Free constant 14	Free constant 14
13.15 Free constant 15	Free constant 15
13.16 Free constant 16	Free constant 16

9.4.2.12 Group 14: Controller values

HMI Text	Note
14.01 Excitation AVR [%]	Excitation AVR [%] (PID control signal)

HMI Text	Note
14.02 Volt. setp. V(f) [%]	Voltage setpoint V(f) [%]
14.03 Excitation SP [%]	Excitation setp point [%]
14.04 Volt. SP SPN 3386 [%]	Voltage setpoint SPN 3386 [%]
14.52 Volt. setp. V(f) [V]	Voltage setpoint V(f) [V]
14.53 Excitation SP [A]	Excitation set point [A] (passed to Exciter-10-P2 via J1939)
14.54 Volt. SP SPN 3386 [V]	Voltage setpoint SPN 3386 [V] passed to standard AVR

9.4.2.13 Group 15: Controller setpoints 2

HMI Text	Note
15.01 Int.SP gen.load [%]	PV load reference function: Internal setpoint generator load

9.4.2.14 Group 16: Internal values 2

HMI Text	Note
16.01 Loadshare av P [%]	Average active power from load sharing generators [%]
16.02 Loadshare av Q [%]	Average reactive power from load sharing generators [%]
16.53 Act. loadshare Gen	Number of active load sharing generator.
16.54 React. loadshare Gen	Number of reactive load sharing generator.
16.55 Number of closed GCB	Number of closed GCB in the same segment.
16.56 Consumer load [kW]	PV load reference calculated. Actual consumer load
16.57 Gen.P nominal [kW]	Generator total nominal active power in the system [kW] .
16.58 Gen.Q nominal [kvar]	Generator total nominal reactive power in the system [kvar]

9.4.2.15 Group 21: CAN1 Receive

HMI Text	Note
21.01 CAN1 RPDO1.1	CAN1 RPDO1.1 (value index 3371, signed short)
21.02 CAN1 RPDO1.2	CAN1 RPDO1.2 (value index 3372, signed short)
21.03 CAN1 RPDO1.3	CAN1 RPDO1.3 (value index 3373, signed short)
21.04 CAN1 RPDO1.4	CAN1 RPDO1.4 (value index 3374, signed short)
21.05 CAN1 RPDO2.1	CAN1 RPDO2.1 (value index 3375, signed short)
21.06 CAN1 RPDO2.2	CAN1 RPDO2.2 (value index 3376, signed short)
21.07 CAN1 RPDO2.3	CAN1 RPDO2.3 (value index 3377, signed short)
21.08 CAN1 RPDO2.4	CAN1 RPDO2.4 (value index 3378, signed short)

HMI Text	Note
21.09 CAN1 RPDO3.1	CAN1 RPDO3.1 (value index 3379, signed short)
21.10 CAN1 RPDO3.2	CAN1 RPDO3.2 (value index 3380, signed short)
21.11 CAN1 RPDO3.3	CAN1 RPDO3.3 (value index 3381, signed short)
21.12 CAN1 RPDO3.4	CAN1 RPDO3.4 (value index 3382, signed short)
21.13 CAN1 RPDO4.1	CAN1 RPDO4.1 (value index 3383, signed short)
21.14 CAN1 RPDO4.2	CAN1 RPDO4.2 (value index 3384, signed short)
21.15 CAN1 RPDO4.3	CAN1 RPDO4.3 (value index 3385, signed short)
21.16 CAN1 RPDO4.4	CAN1 RPDO4.4 (value index 3386, signed short)
21.17 CAN1 RPDO5.1	CAN1 RPDO5.1 (value index 3387, signed short)
21.18 CAN1 RPDO5.2	CAN1 RPDO5.2 (value index 3388, signed short)
21.19 CAN1 RPDO5.3	CAN1 RPDO5.3 (value index 3389, signed short)
21.20 CAN1 RPDO5.4	CAN1 RPDO5.4 (value index 3390, signed short)

9.4.2.16 Group 24: Free analog values

Note: In future releases (higher than 2.10-0) the variables 24.05-24.08 will be write-protected with code level CL1.

HMI Text	Note
24.01 Free analog value 1	Free analog value 1 (value index 587, signed short)
24.02 Free analog value 2	Free analog value 2 (value index 588, signed short)
24.03 Free analog value 3	Free analog value 3 (value index 589, signed short)
24.04 Free analog value 4	Free analog value 4 (value index 590, signed short)
24.05 Free analog value 5	Free analog value 5 (value index 591, signed short)
24.06 Free analog value 6	Free analog value 6 (value index 592, signed short)
24.07 Free analog value 7	Free analog value 7 (value index 593, signed short)
24.08 Free analog value 8	Free analog value 8 (value index 594, signed short)

9.4.2.17 Group 54: Modbus Master pulled flags

TRUE if the flag is active

HMI Text	Note
54.01 Mapped AM value 1	Modbus Master mapped AM value 1
54.02 Mapped AM value 2	Modbus Master mapped AM value 2
54.03 Mapped AM value 3	Modbus Master mapped AM value 3
54.04 Mapped AM value 4	Modbus Master mapped AM value 4
54.05 Mapped AM value 5	Modbus Master mapped AM value 5
54.06 Mapped AM value 6	Modbus Master mapped AM value 6
54.07 Mapped AM value 7	Modbus Master mapped AM value 7

HMI Text	Note
54.08 Mapped AM value 8	Modbus Master mapped AM value 8
54.09 Mapped AM value 9	Modbus Master mapped AM value 9
54.10 Mapped AM value 10	Modbus Master mapped AM value 10
54.11 Mapped AM value 11	Modbus Master mapped AM value 11
54.12 Mapped AM value 12	Modbus Master mapped AM value 12
54.13 Mapped AM value 13	Modbus Master mapped AM value 13
54.14 Mapped AM value 14	Modbus Master mapped AM value 14
54.15 Mapped AM value 15	Modbus Master mapped AM value 15
54.16 Mapped AM value 16	Modbus Master mapped AM value 16
54.17 Mapped AM value 17	Modbus Master mapped AM value 17
54.18 Mapped AM value 18	Modbus Master mapped AM value 18
54.19 Mapped AM value 19	Modbus Master mapped AM value 19
54.20 Mapped AM value 20	Modbus Master mapped AM value 20
54.21 Mapped AM value 21	Modbus Master mapped AM value 21
54.22 Mapped AM value 22	Modbus Master mapped AM value 22
54.23 Mapped AM value 23	Modbus Master mapped AM value 23
54.24 Mapped AM value 24	Modbus Master mapped AM value 24
54.25 Mapped AM value 25	Modbus Master mapped AM value 25
54.26 Mapped AM value 26	Modbus Master mapped AM value 26
54.27 Mapped AM value 27	Modbus Master mapped AM value 27
54.28 Mapped AM value 28	Modbus Master mapped AM value 28
54.29 Mapped AM value 29	Modbus Master mapped AM value 29
54.30 Mapped AM value 30	Modbus Master mapped AM value 30
54.31 Mapped AM value 31	Modbus Master mapped AM value 31
54.32 Mapped AM value 32	Modbus Master mapped AM value 32
54.33 Mapped AM value 33	Modbus Master mapped AM value 33
54.34 Mapped AM value 34	Modbus Master mapped AM value 34
54.35 Mapped AM value 35	Modbus Master mapped AM value 35
54.36 Mapped AM value 36	Modbus Master mapped AM value 36
54.37 Mapped AM value 37	Modbus Master mapped AM value 37
54.38 Mapped AM value 38	Modbus Master mapped AM value 38
54.39 Mapped AM value 39	Modbus Master mapped AM value 39
54.40 Mapped AM value 40	Modbus Master mapped AM value 40
54.41 Mapped AM value 41	Modbus Master mapped AM value 41
54.42 Mapped AM value 42	Modbus Master mapped AM value 42
54.43 Mapped AM value 43	Modbus Master mapped AM value 43
54.44 Mapped AM value 44	Modbus Master mapped AM value 44
54.45 Mapped AM value 45	Modbus Master mapped AM value 45

9 Appendix

9.4.2.17 Group 54: Modbus Master pulled flags

HMI Text	Note
54.46 Mapped AM value 46	Modbus Master mapped AM value 46
54.47 Mapped AM value 47	Modbus Master mapped AM value 47
54.48 Mapped AM value 48	Modbus Master mapped AM value 48
54.49 Mapped AM value 49	Modbus Master mapped AM value 49
54.50 Mapped AM value 50	Modbus Master mapped AM value 50
54.51 Mapped AM value 51	Modbus Master mapped AM value 51
54.52 Mapped AM value 52	Modbus Master mapped AM value 52
54.53 Mapped AM value 53	Modbus Master mapped AM value 53
54.54 Mapped AM value 54	Modbus Master mapped AM value 54
54.55 Mapped AM value 55	Modbus Master mapped AM value 55
54.56 Mapped AM value 56	Modbus Master mapped AM value 56
54.57 Mapped AM value 57	Modbus Master mapped AM value 57
54.58 Mapped AM value 58	Modbus Master mapped AM value 58
54.59 Mapped AM value 59	Modbus Master mapped AM value 59
54.60 Mapped AM value 60	Modbus Master mapped AM value 60
54.61 Mapped AM value 61	Modbus Master mapped AM value 61
54.62 Mapped AM value 62	Modbus Master mapped AM value 62
54.63 Mapped AM value 63	Modbus Master mapped AM value 63
54.64 Mapped AM value 64	Modbus Master mapped AM value 64
54.65 Mapped AM value 65	Modbus Master mapped AM value 65
54.66 Mapped AM value 66	Modbus Master mapped AM value 66
54.67 Mapped AM value 67	Modbus Master mapped AM value 67
54.68 Mapped AM value 68	Modbus Master mapped AM value 68
54.69 Mapped AM value 69	Modbus Master mapped AM value 69
54.70 Mapped AM value 70	Modbus Master mapped AM value 70
54.71 Mapped AM value 71	Modbus Master mapped AM value 71
54.72 Mapped AM value 72	Modbus Master mapped AM value 72
54.73 Mapped AM value 73	Modbus Master mapped AM value 73
54.74 Mapped AM value 74	Modbus Master mapped AM value 74
54.75 Mapped AM value 75	Modbus Master mapped AM value 75
54.76 Mapped AM value 76	Modbus Master mapped AM value 76
54.77 Mapped AM value 77	Modbus Master mapped AM value 77
54.78 Mapped AM value 78	Modbus Master mapped AM value 78
54.79 Mapped AM value 79	Modbus Master mapped AM value 79
54.80 Mapped AM value 80	Modbus Master mapped AM value 80
54.81 Mapped AM value 81	Modbus Master mapped AM value 81
54.82 Mapped AM value 82	Modbus Master mapped AM value 82
54.83 Mapped AM value 83	Modbus Master mapped AM value 83

HMI Text	Note
54.84 Mapped AM value 84	Modbus Master mapped AM value 84
54.85 Mapped AM value 85	Modbus Master mapped AM value 85
54.86 Mapped AM value 86	Modbus Master mapped AM value 86
54.87 Mapped AM value 87	Modbus Master mapped AM value 87
54.88 Mapped AM value 88	Modbus Master mapped AM value 88
54.89 Mapped AM value 89	Modbus Master mapped AM value 89
54.90 Mapped AM value 90	Modbus Master mapped AM value 90
54.91 Mapped AM value 91	Modbus Master mapped AM value 91
54.92 Mapped AM value 92	Modbus Master mapped AM value 92
54.93 Mapped AM value 93	Modbus Master mapped AM value 93
54.94 Mapped AM value 94	Modbus Master mapped AM value 94
54.95 Mapped AM value 95	Modbus Master mapped AM value 95
54.96 Mapped AM value 96	Modbus Master mapped AM value 96
54.97 Mapped AM value 97	Modbus Master mapped AM value 97
54.98 Mapped AM value 98	Modbus Master mapped AM value 98
54.99 Mapped AM value 99	Modbus Master mapped AM value 99

9.4.2.18 Group 81: Results 1

Analog outputs of function-related AnalogManagers.

HMI Text	Note
81.01 AM Preglow criterion	Preglow criterion
81.02 AM Warm-up criterion	Engine warm-up criterion
81.03 AM Frequency SP1[Hz]	Frequency setpoint 1 source [Hz]
81.04 AM Frequency SP2[Hz]	Frequency setpoint 2 source [Hz]
81.05 AM ActPower SP1 [kW]	Active power setpoint 1 source [kW]
81.06 AM ActPower SP2 [kW]	Active power setpoint 2 source [kW]
81.07 AM ActPower SP3 [kW]	Active power setpoint 3 source [kW]
81.08 AM ActPower SP4 [kW]	Active power setpoint 4 source [kW]
81.09 AM Voltage SP1 [V]	Voltage setpoint 1 source [V]
81.10 AM Voltage SP2 [V]	Voltage setpoint 2 source [V]
81.11 AM PF/var SP1[-/kvar]	PF/kvar setpoint 1 source [-/var]
81.12 AM PF/var SP2[-/kvar]	PF/kvar setpoint 2 source [-/var]
81.13 AM PID1 setpoint	PID 1 control setpoint
81.14 AM PID1 actual value	PID 1 control actual value
81.15 AM PID2 setpoint	PID 2 control setpoint
81.16 AM PID2 actual value	PID 2 control actual value
81.17 AM PID3 setpoint	PID 3 control setpoint

HMI Text	Note
81.18 AM PID3 actual value	PID 3 control actual value
81.19 AM Ext.mains act.pwr.	External measured mains active power
81.20 AM Ext.mains RPower	External measured mains reactive power
81.21 AM Derating source	Free derating source
81.22 AM ECU seq.A_IN_1	ECU sequencer analog input 1
81.23 AM ECU seq.A_IN_2	ECU sequencer analog input 2
81.24 AM Engine speed	Engine speed [rpm]
81.25 AM Engine oil press.	Engine oil pressure
81.26 AM Engine hours	Engine hours
81.27 AM Engine fuel level	Engine fuel level [%]
81.28 AM Engine batt.volt.	Engine battery voltage [V]
81.29 AM Engine coolant T	Engine coolant water temperature
81.30 AM Consumer load [kW]	Consumer load [kW]
81.31 AM Reference VQ0	Reference VQ0
81.32 AM Q/P ref.offset	Q/P reference offset
81.34 AM Gen.min power [%]	PV control: Setpoint generator load
81.35 AM SP PID-source [%]	Voltage setpoint PID source for J1939 AVR
81.36 AM Source exc.SP [%]	Source for excitation setpoint AVR bridge
81.37 AM PV rated pwr [kW]	PV rated active power
81.38 AM PV actual pwr [kW]	PV actual active power
81.39 AM Gen. group1 [kW]	Actual active power Generator group 1
81.40 AM Gen. group2 [kW]	Actual active power Generator group 2
81.41 AM Gen.min power [kW]	Generator minimum active power

9.4.2.19 Group 82: Results 2

Analog outputs of function-related AnalogManagers.

HMI Text	Note
82.01 AM FlexLim 1 source	Flexible Limit 1 data source
82.02 AM FlexLim 2 source	Flexible Limit 2 data source
82.03 AM FlexLim 3 source	Flexible Limit 3 data source
82.04 AM FlexLim 4 source	Flexible Limit 4 data source
82.05 AM FlexLim 5 source	Flexible Limit 5 data source
82.06 AM FlexLim 6 source	Flexible Limit 6 data source
82.07 AM FlexLim 7 source	Flexible Limit 7 data source
82.08 AM FlexLim 8 source	Flexible Limit 8 data source
82.09 AM FlexLim 9 source	Flexible Limit 9 data source
82.10 AM FlexLim 10 source	Flexible Limit 10 data source

HMI Text	Note
82.11 AM FlexLim 11 source	Flexible Limit 11 data source
82.12 AM FlexLim 12 source	Flexible Limit 12 data source
82.13 AM FlexLim 13 source	Flexible Limit 13 data source
82.14 AM FlexLim 14 source	Flexible Limit 14 data source
82.15 AM FlexLim 15 source	Flexible Limit 15 data source
82.16 AM FlexLim 16 source	Flexible Limit 16 data source
82.17 AM FlexLim 17 source	Flexible Limit 17 data source
82.18 AM FlexLim 18 source	Flexible Limit 18 data source
82.19 AM FlexLim 19 source	Flexible Limit 19 data source
82.20 AM FlexLim 20 source	Flexible Limit 20 data source
82.21 AM FlexLim 21 source	Flexible Limit 21 data source
82.22 AM FlexLim 22 source	Flexible Limit 22 data source
82.23 AM FlexLim 23 source	Flexible Limit 23 data source
82.24 AM FlexLim 24 source	Flexible Limit 24 data source
82.25 AM FlexLim 25 source	Flexible Limit 25 data source
82.26 AM FlexLim 26 source	Flexible Limit 26 data source
82.27 AM FlexLim 27 source	Flexible Limit 27 data source
82.28 AM FlexLim 28 source	Flexible Limit 28 data source
82.29 AM FlexLim 29 source	Flexible Limit 29 data source
82.30 AM FlexLim 30 source	Flexible Limit 30 data source
82.31 AM FlexLim 31 source	Flexible Limit 31 data source
82.32 AM FlexLim 32 source	Flexible Limit 32 data source
82.33 AM FlexLim 33 source	Flexible Limit 33 data source
82.34 AM FlexLim 34 source	Flexible Limit 34 data source
82.35 AM FlexLim 35 source	Flexible Limit 35 data source
82.36 AM FlexLim 36 source	Flexible Limit 36 data source
82.37 AM FlexLim 37 source	Flexible Limit 37 data source
82.38 AM FlexLim 38 source	Flexible Limit 38 data source
82.39 AM FlexLim 39 source	Flexible Limit 39 data source
82.40 AM FlexLim 40 source	Flexible Limit 40 data source

9.4.2.20 Group 90: Internal Values 0

Analog outputs of function-related AnalogManagers.

HMI Text	Note
90.01 AM Cust.screen 1.1	Customer defined screen 1 row 1
90.02 AM Cust.screen 1.2	Customer defined screen 1 row 2
90.03 AM Cust.screen 1.3	Customer defined screen 1 row 3

HMI Text	Note
90.04 AM Cust.screen 1.4	Customer defined screen 1 row 4
90.05 AM Cust.screen 1.5	Customer defined screen 1 row 5
90.06 AM Cust.screen 1.6	Customer defined screen 1 row 6
90.07 AM Cust.screen 1.7	Customer defined screen 1 row 7
90.08 AM Cust.screen 1.8	Customer defined screen 1 row 8
90.09 AM Cust.screen 1.9	Customer defined screen 1 row 9
90.51 AM Cust.screen 2.1	Customer defined screen 2 row 1
90.52 AM Cust.screen 2.2	Customer defined screen 2 row 2
90.53 AM Cust.screen 2.3	Customer defined screen 2 row 3
90.54 AM Cust.screen 2.4	Customer defined screen 2 row 4
90.55 AM Cust.screen 2.5	Customer defined screen 2 row 5
90.56 AM Cust.screen 2.6	Customer defined screen 2 row 6
90.57 AM Cust.screen 2.7	Customer defined screen 2 row 7
90.58 AM Cust.screen 2.8	Customer defined screen 2 row 8
90.59 AM Cust.screen 2.9	Customer defined screen 2 row 9

9.4.2.21 Group 91: Internal Values 1

Analog outputs of function-related AnalogManagers.

HMI Text	Note
91.01 AM Internal value 1	Internal value 1
91.02 AM Internal value 2	Internal value 2
91.03 AM Internal value 3	Internal value 3
91.04 AM Internal value 4	Internal value 4
91.05 AM Internal value 5	Internal value 5
91.06 AM Internal value 6	Internal value 6
91.07 AM Internal value 7	Internal value 7
91.08 AM Internal value 8	Internal value 8
91.09 AM Internal value 9	Internal value 9
91.10 AM Internal value 10	Internal value 10
91.11 AM Internal value 11	Internal value 11
91.12 AM Internal value 12	Internal value 12
91.13 AM Internal value 13	Internal value 13
91.14 AM Internal value 14	Internal value 14
91.15 AM Internal value 15	Internal value 15
91.16 AM Internal value 16	Internal value 16

9.4.2.22 Group 93: Analog Outputs 1

Analog outputs of function-related AnalogManagers.

HMI Text	Note
93.01 AM Data source AO1	Analog output 1 data source
93.02 AM Data source AO2	Analog output 2 data source
93.03 AM Data source AO3	Analog output 3 data source
93.04 AM Data source AO4	Analog output 4 data source
93.05 AM Data source AO5	Analog output 5 data source
93.06 AM Data source AO6	Analog output 6 data source
93.21 AM Data s. ext. AO1	External Analog output 1 data source
93.22 AM Data s. ext. AO2	External Analog output 2 data source
93.23 AM Data s. ext. AO3	External Analog output 3 data source
93.24 AM Data s. ext. AO4	External Analog output 4 data source

9.4.3 Factory Settings

AnalogManager's default settings

ID	Name	Operator	Default setting/value
5518	AM Frequency SP1[Hz]	Analog1 ("A1 =")	05.51 Internal f setp1 [Hz]
		Analog2 ("A2 =")	10.01 ZERO
		Constant1 ("C1 =")	0
		Function Type ("Type =")	Pass through
		Logic1 "L1"	02.01 LM FALSE
		Logic2 "L2"	02.01 LM FALSE
		Operators:	
		Operators-Unary1	-----
		Operators-Unary2	-----
5519	AM Frequency SP2[Hz]	Analog1 ("A1 =")	05.52 Internal f setp2 [Hz]
		Analog2 ("A2 =")	10.01 ZERO
		Constant1 ("C1 =")	0
		Function Type ("Type =")	Pass through
		Logic1 "L1"	02.01 LM FALSE
		Logic2 "L2"	02.01 LM FALSE
		Operators:	
		Operators-Unary1	-----
		Operators-Unary2	-----
5602	AM V. SP PID-source [%]	Analog1 ("A1 =")	11.02 Voltage bias [%]

ID	Name	Operator	Default setting/value
		Analog2 ("A2 =")	10.01 ZERO
		Constant1 ("C1 =")	0
		Function Type ("Type =")	Pass through
		Logic1 "L1"	02.01 LM FALSE
		Logic2 "L2"	02.01 LM FALSE
		Operators:	
		Operators-Unary1	-----
		Operators-Unary2	-----
15147	AM Derating source	Analog1 ("A1 =")	10.01 ZERO
		Analog2 ("A2 =")	10.01 ZERO
		Constant1 ("C1 =")	0
		Function Type ("Type =")	Pass through
		Logic1 "L1"	02.01 LM FALSE
		Logic2 "L2"	02.01 LM FALSE
		Operators:	
		Operators-Unary1	-----
5539	AM ActPower SP1 [kW]	Analog1 ("A1 =")	05.54 Internal P setp1 [kW]
		Analog2 ("A2 =")	10.01 ZERO
		Constant1 ("C1 =")	0
		Function Type ("Type =")	Pass through
		Logic1 "L1"	02.01 LM FALSE
		Logic2 "L2"	02.01 LM FALSE
		Operators:	
		Operators-Unary1	-----
5540	AM ActPower SP2 [kW]	Analog1 ("A1 =")	05.55 Internal P setp2 [kW]
		Analog2 ("A2 =")	10.01 ZERO
		Constant1 ("C1 =")	0
		Function Type ("Type =")	Pass through
		Logic1 "L1"	02.01 LM FALSE
		Logic2 "L2"	02.01 LM FALSE
		Operators:	
		Operators-Unary1	-----
5606	AM ActPower SP3 [kW]	Analog1 ("A1 =")	05.80 Internal P setp3 [kW]
		Analog2 ("A2 =")	10.01 ZERO
		Constant1 ("C1 =")	0

ID	Name	Operator	Default setting/value
		Function Type ("Type =")	Pass through
		Logic1 "L1"	02.01 LM FALSE
		Logic2 "L2"	02.01 LM FALSE
		Operators:	
		Operators-Unary1	-----
		Operators-Unary2	-----
		5609	AM ActPower SP4 [kW]
		Analog2 ("A2 =")	10.01 ZERO
		Constant1 ("C1 =")	0
		Function Type ("Type =")	Pass through
		Logic1 "L1"	02.01 LM FALSE
		Logic2 "L2"	02.01 LM FALSE
		Operators:	
		Operators-Unary1	-----
		Operators-Unary2	-----
5538	AM Warm-up criterion	Analog1 ("A1 =")	10.01 ZERO
		Analog2 ("A2 =")	10.01 ZERO
		Constant1 ("C1 =")	0
		Function Type ("Type =")	Pass through
		Logic1 "L1"	02.01 LM FALSE
		Logic2 "L2"	02.01 LM FALSE
		Operators:	
		Operators-Unary1	-----
		Operators-Unary2	-----
5638	AM PF/kvar SP1[-/kvar]	Analog1 ("A1 =")	05.10 Intern. PF setp1 [%]
		Analog2 ("A2 =")	10.01 ZERO
		Constant1 ("C1 =")	0
		Function Type ("Type =")	Pass through
		Logic1 "L1"	02.01 LM FALSE
		Logic2 "L2"	02.01 LM FALSE
		Operators:	
		Operators-Unary1	-----
		Operators-Unary2	-----
5639	AM PF/kvar SP2[-/kvar]	Analog1 ("A1 =")	05.11 Intern. PF setp2 [%]
		Analog2 ("A2 =")	10.01 ZERO
		Constant1 ("C1 =")	0
		Function Type ("Type =")	Pass through
		Logic1 "L1"	02.01 LM FALSE

ID	Name	Operator	Default setting/value
		Logic2 "L2"	02.01 LM FALSE
		Operators:	
		Operators-Unary1	-----
		Operators-Unary2	-----
3346	AM Preglow criterion	Analog1 ("A1 =")	10.01 ZERO
		Analog2 ("A2 =")	10.01 ZERO
		Constant1 ("C1 =")	0
		Function Type ("Type =")	Pass through
		Logic1 "L1"	02.01 LM FALSE
		Logic2 "L2"	02.01 LM FALSE
		Operators:	
		Operators-Unary1	-----
		Operators-Unary2	-----
5618	AM Voltage SP1 [V]	Analog1 ("A1 =")	05.57 Internal v setp1 [V]
		Analog2 ("A2 =")	10.01 ZERO
		Constant1 ("C1 =")	0
		Function Type ("Type =")	Pass through
		Logic1 "L1"	02.01 LM FALSE
		Logic2 "L2"	02.01 LM FALSE
		Operators:	
		Operators-Unary1	-----
		Operators-Unary2	-----
5619	AM Voltage SP2 [V]	Analog1 ("A1 =")	05.58 Internal v setp2 [V]
		Analog2 ("A2 =")	10.01 ZERO
		Constant1 ("C1 =")	0
		Function Type ("Type =")	Pass through
		Logic1 "L1"	02.01 LM FALSE
		Logic2 "L2"	02.01 LM FALSE
		Operators:	
		Operators-Unary1	-----
		Operators-Unary2	-----
5577	AM PID1 setpoint	Analog1 ("A1 =")	05.75 Int. PID1 setpoint
		Analog2 ("A2 =")	10.01 ZERO
		Constant1 ("C1 =")	0
		Function Type ("Type =")	Pass through
		Logic1 "L1"	02.01 LM FALSE
		Logic2 "L2"	02.01 LM FALSE
		Operators:	

ID	Name	Operator	Default setting/value
		Operators-Unary1	-----
		Operators-Unary2	-----
5578	AM PID1 actual value	Analog1 ("A1 =")	10.01 ZERO
		Analog2 ("A2 =")	10.01 ZERO
		Constant1 ("C1 =")	0
		Function Type ("Type =")	Pass through
		Logic1 "L1"	02.01 LM FALSE
		Logic2 "L2"	02.01 LM FALSE
		Operators:	
		Operators-Unary1	-----
		Operators-Unary2	-----
		5590	AM PID2 setpoint
Analog2 ("A2 =")	10.01 ZERO		
Constant1 ("C1 =")	0		
Function Type ("Type =")	Pass through		
Logic1 "L1"	02.01 LM FALSE		
Logic2 "L2"	02.01 LM FALSE		
Operators:			
Operators-Unary1	-----		
Operators-Unary2	-----		
5591	AM PID2 actual value		
		Analog2 ("A2 =")	10.01 ZERO
		Constant1 ("C1 =")	0
		Function Type ("Type =")	Pass through
		Logic1 "L1"	02.01 LM FALSE
		Logic2 "L2"	02.01 LM FALSE
		Operators:	
		Operators-Unary1	-----
		Operators-Unary2	-----
		5676	AM PID3 setpoint
Analog2 ("A2 =")	10.01 ZERO		
Constant1 ("C1 =")	0		
Function Type ("Type =")	Pass through		
Logic1 "L1"	02.01 LM FALSE		
Logic2 "L2"	02.01 LM FALSE		
Operators:			
Operators-Unary1	-----		
Operators-Unary2	-----		

ID	Name	Operator	Default setting/value
5677	AM PID3 actual value	Analog1 ("A1 =")	10.01 ZERO
		Analog2 ("A2 =")	10.01 ZERO
		Constant1 ("C1 =")	0
		Function Type ("Type =")	Pass through
		Logic1 "L1"	02.01 LM FALSE
		Logic2 "L2"	02.01 LM FALSE
		Operators:	
		Operators-Unary1	-----
		Operators-Unary2	-----
3346	AM Preglow criterion	Analog1 ("A1 =")	10.01 ZERO
		Analog2 ("A2 =")	10.01 ZERO
		Constant1 ("C1 =")	0
		Function Type ("Type =")	Pass through
		Logic1 "L1"	02.01 LM FALSE
		Logic2 "L2"	02.01 LM FALSE
		Operators:	
		Operators-Unary1	-----
		Operators-Unary2	-----
5200	AM Data source AO1	Analog1 ("A1 =")	11.03 Speed bias [%]
		Analog2 ("A2 =")	10.01 ZERO
		Constant1 ("C1 =")	0
		Function Type ("Type =")	Pass through
		Logic1 "L1"	02.01 LM FALSE
		Logic2 "L2"	02.01 LM FALSE
		Operators:	
		Operators-Unary1	-----
		Operators-Unary2	-----
5214	AM Data source AO2	Analog1 ("A1 =")	11.02 Voltage bias [%]
		Analog2 ("A2 =")	10.01 ZERO
		Constant1 ("C1 =")	0
		Function Type ("Type =")	Pass through
		Logic1 "L1"	02.01 LM FALSE
		Logic2 "L2"	02.01 LM FALSE
		Operators:	
		Operators-Unary1	-----
		Operators-Unary2	-----
5228	AM Data source AO3	Analog1 ("A1 =")	01.05 Gen.volt.L-L [%]
		Analog2 ("A2 =")	10.01 ZERO

ID	Name	Operator	Default setting/value
		Constant1 ("C1 =")	0
		Function Type ("Type =")	Pass through
		Logic1 "L1"	02.01 LM FALSE
		Logic2 "L2"	02.01 LM FALSE
		Operators:	
		Operators-Unary1	-----
		Operators-Unary2	-----
5242	AM Data source AO4	Analog1 ("A1 =")	01.24 Gen.act.power [%]
		Analog2 ("A2 =")	10.01 ZERO
		Constant1 ("C1 =")	0
		Function Type ("Type =")	Pass through
		Logic1 "L1"	02.01 LM FALSE
		Logic2 "L2"	02.01 LM FALSE
		Operators:	
		Operators-Unary1	-----
		Operators-Unary2	-----
5256	AM Data source AO5	Analog1 ("A1 =")	01.20 Gen. PF [%]
		Analog2 ("A2 =")	10.01 ZERO
		Constant1 ("C1 =")	0
		Function Type ("Type =")	Pass through
		Logic1 "L1"	02.01 LM FALSE
		Logic2 "L2"	02.01 LM FALSE
		Operators:	
		Operators-Unary1	-----
		Operators-Unary2	-----
5270	AM Data source AO6	Analog1 ("A1 =")	01.09 Gen.frequency [%]
		Analog2 ("A2 =")	10.01 ZERO
		Constant1 ("C1 =")	0
		Function Type ("Type =")	Pass through
		Logic1 "L1"	02.01 LM FALSE
		Logic2 "L2"	02.01 LM FALSE
		Operators:	
		Operators-Unary1	-----
		Operators-Unary2	-----
10237	AM Data source ext.AO1	Analog1 ("A1 =")	11.03 Speed bias [%]
		Analog2 ("A2 =")	10.01 ZERO
		Constant1 ("C1 =")	0
		Function Type ("Type =")	Pass through

ID	Name	Operator	Default setting/value
		Logic1 "L1"	02.01 LM FALSE
		Logic2 "L2"	02.01 LM FALSE
		Operators:	
		Operators-Unary1	-----
		Operators-Unary2	-----
10247	AM Data source ext.AO2	Analog1 ("A1 =")	11.03 Speed bias [%]
		Analog2 ("A2 =")	10.01 ZERO
		Constant1 ("C1 =")	0
		Function Type ("Type =")	Pass through
		Logic1 "L1"	02.01 LM FALSE
		Logic2 "L2"	02.01 LM FALSE
		Operators:	
		Operators-Unary1	-----
		Operators-Unary2	-----
10257	AM Data source ext.AO3	Analog1 ("A1 =")	11.03 Speed bias [%]
		Analog2 ("A2 =")	10.01 ZERO
		Constant1 ("C1 =")	0
		Function Type ("Type =")	Pass through
		Logic1 "L1"	02.01 LM FALSE
		Logic2 "L2"	02.01 LM FALSE
		Operators:	
		Operators-Unary1	-----
		Operators-Unary2	-----
10267	AM Data source ext.AO4	Analog1 ("A1 =")	11.03 Speed bias [%]
		Analog2 ("A2 =")	10.01 ZERO
		Constant1 ("C1 =")	0
		Function Type ("Type =")	Pass through
		Logic1 "L1"	02.01 LM FALSE
		Logic2 "L2"	02.01 LM FALSE
		Operators:	
		Operators-Unary1	-----
		Operators-Unary2	-----
15162	AM ECU seq.A_IN_1	Analog1 ("A1 =")	10.01 ZERO
		Analog2 ("A2 =")	10.01 ZERO
		Constant1 ("C1 =")	0
		Function Type ("Type =")	Pass through
		Logic1 "L1"	02.01 LM FALSE
		Logic2 "L2"	02.01 LM FALSE

ID	Name	Operator	Default setting/value
		Operators:	
		Operators-Unary1	-----
		Operators-Unary2	-----
15163	AM ECU seq.A_IN_2	Analog1 ("A1 =")	10.01 ZERO
		Analog2 ("A2 =")	10.01 ZERO
		Constant1 ("C1 =")	0
		Function Type ("Type =")	Pass through
		Logic1 "L1"	02.01 LM FALSE
		Logic2 "L2"	02.01 LM FALSE
		Operators:	
		Operators-Unary1	-----
		Operators-Unary2	-----
8252	PV rated active power	Analog1 ("A1 =")	10.01 ZERO
		Analog2 ("A2 =")	10.01 ZERO
		Constant1 ("C1 =")	0
		Function Type ("Type =")	Pass through
		Logic1 "L1"	02.01 LM FALSE
		Logic2 "L2"	02.01 LM FALSE
		Operators:	
		Operators-Unary1	-----
		Operators-Unary2	-----
8255	PV actual active power	Analog1 ("A1 =")	10.01 ZERO
		Analog2 ("A2 =")	10.01 ZERO
		Constant1 ("C1 =")	0
		Function Type ("Type =")	Pass through
		Logic1 "L1"	02.01 LM FALSE
		Logic2 "L2"	02.01 LM FALSE
		Operators:	
		Operators-Unary1	-----
		Operators-Unary2	-----
8260	Gen.group1 active power	Analog1 ("A1 =")	10.90 Generator load [kW]
		Analog2 ("A2 =")	10.01 ZERO
		Constant1 ("C1 =")	0
		Function Type ("Type =")	Pass through
		Logic1 "L1"	02.01 LM FALSE
		Logic2 "L2"	02.01 LM FALSE
		Operators:	
		Operators-Unary1	-----

ID	Name	Operator	Default setting/value
		Operators-Unary2	-----
8265	Gen.group2 active power	Analog1 ("A1 =")	10.01 ZERO
		Analog2 ("A2 =")	10.01 ZERO
		Constant1 ("C1 =")	0
		Function Type ("Type =")	Pass through
		Logic1 "L1"	02.01 LM FALSE
		Logic2 "L2"	02.01 LM FALSE
		Operators:	
		Operators-Unary1	-----
		Operators-Unary2	-----
8270	Gen.minimum power	Analog1 ("A1 =")	10.01 ZERO
		Analog2 ("A2 =")	10.01 ZERO
		Constant1 ("C1 =")	100
		Function Type ("Type =")	Constant
		Logic1 "L1"	02.01 LM FALSE
		Logic2 "L2"	02.01 LM FALSE
		Operators:	
		Operators-Unary1	-----
		Operators-Unary2	-----
8914	AM PV SP gen.min.load	Analog1 ("A1 =")	15.01 Int.SP gen.load [%]
		Analog2 ("A2 =")	10.01 ZERO
		Constant1 ("C1 =")	0
		Function Type ("Type =")	Pass through
		Logic1 "L1"	02.01 LM FALSE
		Logic2 "L2"	02.01 LM FALSE
		Operators:	
		Operators-Unary1	-----
		Operators-Unary2	-----
9640	AM Internal value 1	Analog1 ("A1 =")	10.01 ZERO
9644	AM Internal value 2	Analog2 ("A2 =")	10.01 ZERO
9648	AM Internal value 3	Constant1 ("C1 =")	0
9652	AM Internal value 4	Function Type ("Type =")	Pass through
9656	AM Internal value 5	Logic1 "L1"	02.01 LM FALSE
9660	AM Internal value 6	Logic2 "L2"	02.01 LM FALSE
9664	AM Internal value 7	Operators:	
9668	AM Internal value 8	Operators-Unary1	-----
9672	AM Internal value 9	Operators-Unary2	-----
9676	AM Internal value 10		

ID	Name	Operator	Default setting/value
9680	AM Internal value 11		
9684	AM Internal value 12		
9688	AM Internal value 13		
9692	AM Internal value 14		
9696	AM Internal value 15		
9700	AM Internal value 16		
5780	AM Ext.mains act.pwr	Analog1 ("A1 =")	06.01 Analog input 1
		Analog2 ("A2 =")	10.01 ZERO
		Constant1 ("C1 =")	0
		Function Type ("Type =")	Pass through
		Logic1 "L1"	02.01 LM FALSE
		Logic2 "L2"	02.01 LM FALSE
		Operators:	
		Operators-Unary1	-----
		Operators-Unary2	-----
5794	AM Ext.mains RPower	Analog1 ("A1 =")	06.02 Analog input 2
		Analog2 ("A2 =")	10.01 ZERO
		Constant1 ("C1 =")	0
		Function Type ("Type =")	Pass through
		Logic1 "L1"	02.01 LM FALSE
		Logic2 "L2"	02.01 LM FALSE
		Operators:	
		Operators-Unary1	-----
		Operators-Unary2	-----
4206	AM FlexLim 1 source	Analog1 ("A1 =")	10.01 ZERO
4223	AM FlexLim 2 source	Analog2 ("A2 =")	10.01 ZERO
4240	AM FlexLim 3 source	Constant1 ("C1 =")	0
4257	AM FlexLim 4 source	Function Type ("Type =")	Pass through
4276	AM FlexLim 5 source	Logic1 "L1"	02.01 LM FALSE
4286	AM FlexLim 6 source	Logic2 "L2"	02.01 LM FALSE
4296	AM FlexLim 7 source	Operators:	
		Operators-Unary1	-----
		Operators-Unary2	-----
6006	AM FlexLim 8 source	Analog1 ("A1 =")	10.01 ZERO
6016	AM FlexLim 9 source	Analog2 ("A2 =")	10.01 ZERO
6026	AM FlexLim 10 source	Constant1 ("C1 =")	0
6026 + (N x (+10))	AM FlexLim 11 source - AM FlexLim 39 source	Function Type ("Type =")	Pass through
		Logic1 "L1"	02.01 LM FALSE

ID	Name	Operator	Default setting/value
...	...	Logic2 "L2"	02.01 LM FALSE
6326	AM FlexLim 40 source	Operators:	
		Operators-Unary1	-----
		Operators-Unary2	-----
7690	AM Customer screen 1.1	Analog1 ("A1 =")	10.01 ZERO
7695	AM Customer screen 1.2	Analog2 ("A2 =")	10.01 ZERO
7700	AM Customer screen 1.3	Constant1 ("C1 =")	0
7705	AM Customer screen 1.4	Function Type ("Type =")	Pass through
7710	AM Customer screen 1.5	Logic1 "L1"	02.01 LM FALSE
7715	AM Customer screen 1.6	Logic2 "L2"	02.01 LM FALSE
7720	AM Customer screen 1.7	Operators:	-----
7725	AM Customer screen 1.8	Operators-Unary1	-----
7730	AM Customer screen 1.9	Operators-Unary2	
7735	AM Customer screen 2.1		
7740	AM Customer screen 2.2		
7745	AM Customer screen 2.3		
7750	AM Customer screen 2.4		
7755	AM Customer screen 2.5		
7760	AM Customer screen 2.6		
7765	AM Customer screen 2.7		
7770	AM Customer screen 2.8		
7775	AM Customer screen 2.9		
8891	AM Engine speed	Analog1 ("A1 =")	11.51 Engine speed [rpm]
		Analog2 ("A2 =")	10.02 ONE10.02 ONE
		Constant1 ("C1 =")	0
		Function Type ("Type =")	Pass through
		Logic1 "L1"	02.01 LM FALSE
		Logic2 "L2"	02.01 LM FALSE
		Operators:	
		Operators-Unary1	-----
Operators-Unary2	-----		
8893	AM Engine oil pressure	Analog1 ("A1 =")	07.07 100:Engine Oil Press.
		Analog2 ("A2 =")	10.02 ONE
		Constant1 ("C1 =")	0
		Function Type ("Type =")	Pass through
		Logic1 "L1"	02.01 LM FALSE
		Logic2 "L2"	02.01 LM FALSE

ID	Name	Operator	Default setting/value
		Operators:	
		Operators-Unary1	-----
		Operators-Unary2	-----
8895	AM Engine hours	Analog1 ("A1 =")	11.55 Eng.oper.hours [h]
		Analog2 ("A2 =")	10.02 ONE
		Constant1 ("C1 =")	0
		Function Type ("Type =")	Pass through
		Logic1 "L1"	02.01 LM FALSE
		Logic2 "L2"	02.01 LM FALSE
		Operators:	
		Operators-Unary1	-----
		Operators-Unary2	-----
8897	AM Engine fuel level	Analog1 ("A1 =")	06.03 Analog input 3
		Analog2 ("A2 =")	10.02 ONE
		Constant1 ("C1 =")	0
		Function Type ("Type =")	Pass through
		Logic1 "L1"	02.01 LM FALSE
		Logic2 "L2"	02.01 LM FALSE
		Operators:	
		Operators-Unary1	-----
		Operators-Unary2	-----
8899	AM Engine batt.voltage	Analog1 ("A1 =")	10.54 Battery voltage [V]
		Analog2 ("A2 =")	10.02 ONE
		Constant1 ("C1 =")	0
		Function Type ("Type =")	Pass through
		Logic1 "L1"	02.01 LM FALSE
		Logic2 "L2"	02.01 LM FALSE
		Operators:	
		Operators-Unary1	-----
		Operators-Unary2	-----
8901	AM Engine coolant temp.	Analog1 ("A1 =")	07.15 110:Eng.Coolant Temp.
		Analog2 ("A2 =")	10.02 ONE
		Constant1 ("C1 =")	0
		Function Type ("Type =")	Pass through
		Logic1 "L1"	02.01 LM FALSE
		Logic2 "L2"	02.01 LM FALSE
		Operators:	
		Operators-Unary1	-----

ID	Name	Operator	Default setting/value
		Operators-Unary2	-----
9059	AM Consumer load [kW]	Analog1 ("A1 =")	02.74 Mains act.power [W]
		Analog2 ("A2 =")	10.02 ONE
		Constant1 ("C1 =")	-0.001
		Function Type ("Type =")	Multiply type C
		Logic1 "L1"	02.01 LM FALSE
		Logic2 "L2"	02.01 LM FALSE
		Operators:	
		Operators-Unary1	-----
		Operators-Unary2	-----

Table 163: Factory settings: AnalogManager

9.5 Status, Event And Alarm Reference

9.5.1 Status messages

Message text	ID	Meaning
STOP mode	14354	Operation mode STOP is active
Operation mode TEST	4685	Operation mode TEST is active The unit is running a test procedure according to the configuration.
MAN mode	14355	Operation mode MANUAL is active
AUTO mode	14353	Operation mode AUTOMATIC is active
AUTO mode ready	13253	Automatic mode ready for start The unit is waiting for a start signal in Automatic operating mode and no alarm of class C, D, E, or F is present.
Aux. services prerun	13201	Prerun of the auxiliary operation is active Before the engine is started the signal "aux. services prerun" is enabled, so that all required equipment which is necessary for the operation of the engine can be initialized, started or switched.
Cool down	13204	Coasting of the engine is active The no load operation is performed prior to the stopping of the engine. The no load operation is utilized to cool the engine.
Crank protect	13214	Starter protection To prevent the starter from being damaged by an engine that is rotating, a crank protection delay is active to ensure that the engine has time to stop rotating.
Idle run active	13216	The control is in idle mode No undervoltage, underfrequency, and underspeed monitoring is performed in idle mode. The flexible limits 33 through 40 are not monitored.

Message text	ID	Meaning
Gen. stable time	13250	Generator stable time is active If the engine monitoring delay timer has expired, the generator settling time starts. This permits for an additional delay time before the breaker is closed in order to ensure that none of the engine delayed watchdogs trips.
Aux. serv. postrun	13200	Postrun of the auxiliary operation is active After the engine has stopped, auxiliary operations are enabled. These operations ensure that required equipment which is necessary for the operation of the engine continues to run (i.e. electric cooling fan).
In operation	13251	The genset is in regular operation The genset is in regular operation and is ready for supplying load.
Start - Pause	13207	Start pause while starting the engine is active If the engine could not be started, the controller will pause for the configured time prior to attempting to issuing a start command again.
Stop engine	13203	Engine will be stopped The engine will be stopped. The engine stop delay will be started when ignition speed has been fallen below. A restart is only possible if the engine stop delay has been expired.
Start	13206	Start engine is active After the "Prerun auxiliary operation" expires, the engine is started according to the configured start logic (Diesel or gas engine). When the start sequence is active, various relays are enabled and representative signals are passed via the CAN bus to a secondary engine control.
Ramp to rated	13254	Engine is accelerating to rated speed After firing speed has been exceeded, the engine monitoring delay timer starts. This message is displayed during this period.
Power limited prerun	13252	Active power limited prerun is active The real power setpoint is limited to the warm up power limit for the configured warm up time.
Ignition	13213	Enable the ignition (Gas engine) After the purging operation and before the fuel solenoids opened.
Preglow	13208	Preglow of the engine is active (Diesel engine) The diesel engine is preheated prior to starting.
Turning	13212	Purging operation is active (Gas engine) Before the fuel solenoid opens and the ignition of the gas engine is energized the remaining fuel, that may be present in the combustion chamber, will be removed by a purging operation. The starter turns the engine without enabling the ignition for a specified time to complete the purging operation. After the purging process, the ignition is energized.
Start w/o Load	13263	Start without load is active A regular engine start is performed. The GCB operation is blocked to prevent a change from mains to generator supply.
Emergency run	13211	Emergency power operation

Message text	ID	Meaning
		After the control unit detects that a mains fault has occurred, the engine is started after the emergency delay timer expires. The MCB is opened, the GCB is closed, and the generator set assumes the load. If the generator set is already running, operations continue until the emergency power operation conditions no longer exist. If the mains return, the mains settling timer becomes active first.
Run-up Synchron.	13271	Run-up Synchronization The run-up synchronization mode is active.
Derating active	13281	Derating active As long as the derating function is activated, this text message is shown.
Inhibit cranking	13284	Inhibit cranking The cranking is blocked.
Uprating active	13287	Uprating active As long as the uprating function is activated, this text message is shown.
Gen excitation lim.	13288	Generator excitation limit is reached During regulation kvar at the interchange point the maximum allowed excitation current is reached.
P(V) derating	13309	P(V) derating is active
System update	14763	System update is active The system update procedure is ongoing.
Keypad locked	14775	The keypad easYgen is locked
Loading generator	13258	The generator power will be increased to the setpoint The generator power will be increased to the configured setpoint with a rate defined by the power control setpoint ramp.
Unloading mains	13264	The mains power will be decreased The real power setpoint is increased with the configured rate after synchronizing the generator in interchange transition mode. After the mains have been unloaded, the MCB will be opened.
Unloading generator	13256	The generator power will be decreased The generator power will be decreased after a stop command has been issued with a rate defined by the power control setpoint ramp before the GCB will be opened.
GCB -> MCB Delay	13261	GCB - MCB delay time is active If the breaker logic is configured to Open Transition and a transfer from generator to mains supply is initiated, the transfer time delay will start after the replay "GCB is open" is received. The MCB close command will be issued after the transfer time has expired.
MCB dead bus close	13210	Dead bus closing of the MCB The MCB is closed onto the de-energized busbar. The measured busbar voltage is below the configured dead bus detection limit.
MCB -> GCB Delay	13262	MCB - GCB delay time is active If the breaker logic is configured to Open Transition and a transfer from mains to generator supply is initiated, the transfer time delay will start after the reply "MCB

Message text	ID	Meaning
		is open" is received. The GCB close command will be issued after the transfer time has expired.
Synchronization GCB	13259	The GCB will be synchronized The control tries to synchronize the GCB.
Synchronization MCB	13260	The MCB will be synchronized The control tries to synchronize the MCB.
Mains settling	13205	Mains settling time is active When the control unit detects that the mains fault is no longer present and power has been restored, the mains settling timer begins counting down. If the mains are stable after the expiration of the timer (the mains voltage has not fallen below or risen over the configured monitoring limits), the load is transferred from the generator supply to the mains supply.
Open GCB	13255	The GCB is being opened A GCB open command has been issued.
Open MCB	13257	The MCB is being opened An MCB open command has been issued.
Critical mode	13202	Critical mode (Sprinkler operation) is active The sprinkler operation is activated.
Emergency/Critical	13215	Emergency operation during active critical operation Both Critical mode and Emergency run are activated.
GCB dead bus close	13209	Dead bus closing of the GCB The GCB is closed onto the de-energized busbar. The measured busbar voltage is below the configured dead bus detection limit.
Synch. PERMISSIVE	13265	Synchronization mode PERMISSIVE. The frequency / voltage regulation for synchronization is disabled. The according breaker close pulse is enabled.
Synch. CHECK	13266	Synchronization mode CHECK The frequency / voltage regulation for synchronization is enabled. The according breaker close pulse is disabled.
Synch. OFF	13267	Synchronization mode OFF The frequency / voltage regulation for synchronization is disabled. The close pulse is disabled.
Open GGB	13268	The GGB is being opened A GGB open command has been issued.
Synchronization GGB	13269	The GGB will be synchronized The control tries to synchronize the GGB.
GGB dead bus close	13270	Dead bus closing of the GGB The GGB is closed when the busbar is inside the operating range and the load busbar is dead.

Message text	ID	Meaning
GGB -> MCB Delay	13272	GGB - MCB delay time is active If the breaker logic is configured to Open Transition and a transfer from busbar to mains supply is initiated, the transfer time delay will start after the replay "GGB is open" is received. The MCB close command will be issued after the transfer time has expired.
MCB -> GGB Delay	13273	MCB - GGB delay time is active If the breaker logic is configured to Open Transition and a transfer from mains to generator supply is initiated, the transfer time delay will start after the reply "MCB is open" is received. The GGB close command will be issued after the transfer time has expired.
Unloading LSx	13282	Unloading the LSx The LSx performs a power reduction to make sure that there is little power in the system before opening the breaker.
Synchronization LSx	13283	The LSx will be synchronized The control supports the synchronization of the LSx.
Inh.dead bus closure	13311	Inhibit dead bus closure The dead busbar closure is inhibited.
GCB closure disabled	13247	GCB shall be closed but is not enabled by LM
GGB closure disabled	13248	GGB shall be closed but is not enabled by LM
GC System update	14776	GC System update is active
Frequency droop	14688	Frequency droop is active
Voltage droop	14689	Voltage droop is active

9.5.2 Event History

General notes

The event history is a 1000 entry FIFO (First In/First Out) memory for logging alarm events and operation states of the unit. As new event messages are entered into the history, the oldest messages are deleted once 1000 events have occurred.

For additional information refer to [↗ "5 Operation"](#).

Resetting event history



Make sure to have set the appropriate code level to reset the event history.

If you have not entered the correct password for the required code level, the parameters for resetting the event history are not available (for additional information refer to [↗ "4.3.4.1 Password System - Parameter Overview"](#)).

Three ways to reset Event History

- **ToolKit:** Click the »Clear all « button at [STATUS MENU / Diagnostic / Event History].

(Read Event History at the same page)

- **HMI/display:** Go to [Parameter / Configure system management / Factory default settings] and select »Yes«, then »Clear eventlog« appears. Select »Yes« for »Clear event log«

(To read Event History go to: [Next Page / Diagnostic / Event History])

- **Parameter/remote:** Set parameter  1706 »Clear eventlog«) to "TRUE" (1)
- The complete event history is now being cleared

9.5.3 Event Message

Message text	ID	Meaning
AUTO mode	14353	The unit is switched to AUTO mode
STOP mode	14354	The unit is switched to STOP mode
MAN mode	14355	The unit is switched to MANUAL mode
No load test	4683	Test mode started without load
Load test	4684	Test mode started with load
Operation mode TEST	4685	The unit is switched to TEST mode
MCB opened	14700	The MCB reply signals MCB is open
MCB closed	14701	The MCB reply signals MCB is closed
GCB opened	14702	The GCB reply signals GCB is open
GCB closed	14703	The GCB reply signals GCB is closed
Mains failure	14704	Mains frequency or voltage is not ok
Emergency run	14705	The emergency run is initiated
Engine is running	14706	The engine is started (87.68 LM: Firing speed is TRUE)
Critical mode	14707	The critical mode is initiated
Open command GCB	14718	Control commands GCB open
Close command GCB	14719	Control commands GCB close
Enable GCB	1866	GCB is enabled (86.95 LM: Enable GCB is TRUE)
Enable GGB	1867	GGB is enabled (87.37 LM: Enable GGB is TRUE)
Open command MCB	14720	Control commands MCB open
Close command MCB	14721	Control commands MCB close
Start/Gas	14734	Operating Magnet (Diesel) or Gas valve (gas application)' activated (03.28 Start/Gas is TRUE)
Engine idle run	14762	The engine is running in idle
System update	14763	System update is active
easYgen LS timeout	2440	easYgen loadshare timeout detected. This event logg entry can be enabled by parameter "2442 Load share timeout event ".
LSx LS timeout	2441	LSx loadshare timeout detected. This event logg entry can be enabled by parameter "2442 Load share timeout event ".
Redund. LS timeout	2443	Redundancy loadshare timeout detected. This event logg entry can be enabled by parameter "2442 Load share timeout event ".
Startup power supply	14778	Start up power supply

Message text	ID	Meaning
Power derating act.	16192	Power derating is activated
Power uprating act.	16193	Power uprating is activated
Neutral cont. opened	1842	Neutral contactor is opened
Neutral cont. closed	1843	Neutral contactor is closed
Gen excitation lim.	13288	The limit of the generator's excitation is exceeded
GGB opened	14712	The GGB reply signals GGB is open
GGB closed	14717	The GGB reply signals GGB is closed
Open command GGB	14722	Control commands GGB open
Close command GGB	14723	Control commands GGB close

9.5.4 Alarm Classes



The control functions are structured in the alarm classes listed in the table below.

The background color of the latest alarm displayed on the HMI homescreen does not necessarily correspond to the alarm class of the latest alarm. For example, if the latest alarm is alarm class A but there is still an alarm with alarm class F active or latched, the background color is red.

Alarm class	Visible in the display	LED "Alarm" & horn	Relay "Command: open GCB"	Shut-down engine	Engine blocked until ack. sequence has been performed
A	Yes	No	No	No	No
Warning Alarm	This alarm does not interrupt the unit operation. A message output without a centralized alarm occurs: <ul style="list-style-type: none"> Alarm text. 				
B	Yes	Yes	No	No	No
Warning Alarm	This alarm does not interrupt the unit operation. An output of the centralized alarm occurs and the command variable 3.05 (horn) is issued. <ul style="list-style-type: none"> Alarm text + flashing LED "Alarm" + Relay centralized alarm (horn). 				
C	Yes	Yes	Soft unloading	Cool down time	Yes
Shutdown Alarm	With this alarm the GCB is opened and the engine is stopped. Coasting occurs. <ul style="list-style-type: none"> Alarm text + flashing LED "Alarm" + Relay centralized alarm (horn) + GCB open + Coasting + Engine stop. 				
D	Yes	Yes	Immediately	Cool down time	Yes
Shutdown Alarm	With this alarm the GCB is opened and the engine is stopped. Coasting occurs. <ul style="list-style-type: none"> Alarm text + flashing LED "Alarm" + Relay centralized alarm (horn) + GCB open + Coasting + Engine stop. 				
E	Yes	Yes	Soft unloading	Immediately	Yes
Shutdown Alarm	With this alarm the GCB is opened immediately and the engine is stopped.				

Alarm class	Visible in the display	LED "Alarm" & horn	Relay "Command: open GCB"	Shut-down engine	Engine blocked until ack. sequence has been performed
	• Alarm text + flashing LED "Alarm" + Relay centralized alarm (horn) + GCB open + Engine stop.				
F	Yes	Yes	Immediately	Immediately	Yes
Shutdown Alarm	With this alarm the GCB is opened immediately and the engine is stopped. • Alarm text + flashing LED "Alarm" + Relay centralized alarm (horn) + GCB open + Engine stop.				
Control	No	No	No	No	No
Control Signal	This signal issues a control command only. It may be assigned to a discrete input for example to get a control signal, which may be used in the LogicsManager. No alarm message and no entry in the alarm list or the event history will be issued. This signal is always self-acknowledging, but considers a delay time and may also be configured with an engine delay.				



In manual mode all stopping alarms are without cool down.

CAUTION!



If an alarm of class C, D, or E is present and the GCB cannot be opened, the engine will not be stopped. This can only be achieved by enabling GCB monitoring (parameter [↩➤ 2600](#)) with the alarm class configured to "F" (parameter [↩➤ 2601](#)).

If an alarm has been configured with a shutdown alarm that has been enabled to self-acknowledge, and has been configured as engine delayed the following scenario may happen:

- The alarm shuts down the engine because of its alarm class.
- Due to the engine stopping, all engine delayed alarms are ignored.
- The alarm class is acknowledged automatically.
- The alarm will self-acknowledge and clear the fault message that shut the engine down.

This prevents the fault from being analyzed. After a short delay, the engine will restart.

- After the engine monitoring delay expires, the fault that originally shut down the engine will do so again.

This cycle will continue to repeat until corrected.

9.5.5 Alarm Messages

9.5.5.1 J1939 alarms

Message text	ID	Meaning
J1939	13708	Most J1939 standard visualization values can trigger a dedicated alarm. For a list refer to chapter ↳ "7.5 J1939 Protocol" .

9.5.5.2 No alarm

Message text	ID	Meaning
No alarm active	13328	There is no alarm active.

9.5.5.3 Generator monitoring

Message text	ID	Meaning
Gen. overfrequency 1	1912	Generator overfrequency, limit value 1 The generator frequency has exceeded the limit value 1 for generator overfrequency.
Gen. overfrequency 2	1913	Generator overfrequency, limit value 2 The generator frequency has exceeded the limit value 2 for generator overfrequency.
Gen. underfrequency 1	1962	Generator underfrequency, limit value 1 The generator frequency has fallen below the limit value 1 for generator underfrequency.
Gen. underfrequency 2	1963	Generator underfrequency, limit value 2 The generator frequency has fallen below the limit value 2 for generator underfrequency.
Gen. overvoltage 1	2012	Generator overvoltage, limit value 1 The generator voltage has exceeded the limit value 1 for generator overvoltage.
Gen. overvoltage 2	2013	Generator overvoltage, limit value 2 The generator voltage has exceeded the limit value 2 for generator overvoltage.
Gen. undervoltage 1	2062	Generator undervoltage, limit value 1 The generator voltage has fallen below the limit value 1 for generator undervoltage.
Gen. undervoltage 2	2063	Generator undervoltage, limit value 2 The generator voltage has fallen below the limit value 2 for generator undervoltage.
Gen. overcurrent 1	2218	Generator overcurrent, limit value 1 The generator current has exceeded the limit value 1 for the generator overcurrent.

Message text	ID	Meaning
Gen. overcurrent 2	2219	Generator overcurrent, limit value 2 The generator current has exceeded the limit value 2 for the generator overcurrent.
Gen. overcurrent 3	2220	Generator overcurrent, limit value 3 The generator current has exceeded the limit value 3 for the generator overcurrent.
Inv. time overcurr.	4038	Generator inverse time-overcurrent The generator current has exceeded the limit based on the inverse time overcurrent setting.
Gen. rev./red. pwr.1	2262	Generator reverse power, limit value 1 / Generator reduced power, limit value 1 The generator power has exceeded the limit value 1 for generator reverse power / generator reduced power.
Gen. rev./red. pwr.2	2263	Generator reverse power, limit value 2 / Generator reduced power, limit value 2 The generator power has exceeded the limit value 2 for generator reverse power / generator reduced power.
Gen. overload IOP 1	2314	Generator overload IOP, limit value 1 The generator power has exceeded the limit value 1 for generator overload in islanded operation (MCB is open).
Gen. overload IOP 2	2315	Generator overload IOP, limit value 2 The generator power has exceeded the limit value 2 for generator overload in islanded operation (MCB is open).
Gen. overload MOP 1	2362	Generator overload MOP, limit value 1 The generator power has exceeded the limit value 1 for generator overload in mains parallel operation.
Gen. overload MOP 2	2363	Generator overload MOP, limit value 2 The generator power has exceeded the limit value 2 for generator overload in mains parallel operation.
Unbalanced load 1	2412	Generator unbalanced load, limit value 1 The generator current has exceeded the limit value 1 for generator unbalanced load.
Unbalanced load 2	2413	Generator unbalanced load, limit value 2 The generator current has exceeded the limit value 2 for generator unbalanced load.
Gen. volt. asymmetry	3907	Voltage asymmetry The generator phase-to-phase voltages have higher differences between each other than the configured limit value.
Ground fault 1	3263	Generator ground current, limit value 1 The measured or calculated ground current has exceeded the limit value 1 for the generator ground current.
Ground fault 2	3264	Generator ground current, limit value 2

Message text	ID	Meaning
		The measured or calculated ground current has exceeded the limit value 2 for the generator ground current.
Gen.ph.rot. mismatch	3955	Generator rotating field mismatch The generator rotating field does not correspond with the configured direction.
Gen. PF lagging 1	2337	Generator overexcited, limit value 1 The power factor limit 1 has been exceeded at the generator towards inductive.
Gen. PF lagging 2	2338	Generator overexcited, limit value 2 The power factor limit 2 has been exceeded at the generator towards inductive.
Gen. PF leading 1	2387	Generator underexcited, limit value 1 The power factor limit 1 has fallen below at the generator towards capacitive.
Gen. PF leading 2	2388	Generator underexcited, limit value 2 The power factor limit 2 has fallen below at the generator towards capacitive.
Gen.act.pwr.mismatch	2924	Generator active power mismatch The deviation between the generator power and the active power setpoint has exceeded the limit.
Gen. unloading fault	3124	Generator unloading mismatch The easYgen failed to reduce the generator power below the configured unload limit.
Pole slip	2424	Pole slip Monitoring Alarm active A pole slip was detected during running the generator mains parallel.

9.5.5.4 Busbar monitoring

Message text	ID	Meaning
Busbar v/f not ok	5123	Busbar voltage or frequency is not ok Busbar voltage and frequency are not in range according to the configured limits.
Busb.ph.rot.mismatch	10666	Busbar rotating field mismatch The busbar rotating field does not correspond with the configured direction.

9.5.5.5 Mains monitoring

Message text	ID	Meaning
Mains overfreq. 1	2862	Mains overfrequency, limit value 1 The mains frequency has exceeded the limit value 1 for mains overfrequency.
Mains overfreq. 2	2863	Mains overfrequency, limit value 2 The mains frequency has exceeded the limit value 2 for mains overfrequency.

Message text	ID	Meaning
Mains underfreq. 1	2912	Mains underfrequency, limit value 1 The mains frequency has fallen below the limit value 1 for mains underfrequency.
Mains underfreq. 2	2913	Mains underfrequency, limit value 2 The mains frequency has fallen below the limit value 2 for mains underfrequency.
Mains overvoltage 1	2962	Mains overvoltage, limit value 1 The mains voltage has exceeded the limit value 1 for mains overvoltage.
Mains overvoltage 2	2963	Mains overvoltage, limit value 2 The mains voltage has exceeded the limit value 2 for mains overvoltage.
Mains undervoltage 1	3012	Mains undervoltage, limit value 1 The mains voltage has fallen below the limit value 1 for mains undervoltage.
Mains undervoltage 2	3013	Mains undervoltage, limit value 2 The mains voltage has fallen below the limit value 2 for mains undervoltage.
Mains phase shift	3057	Mains phase shift A mains phase shift, which has exceeded the configured limit, has occurred.
Mains df/dt	3106	Mains df/dt (ROCOF) A mains df/dt, which has exceeded the configured limit, has occurred. Triggering this monitoring function causes the mains decoupling function to trigger.
Mains decoupling	3114	Mains decoupling is initiated One or more monitoring function(s) considered for the mains decoupling functionality has triggered.
Decoupling GCB<->MCB	5147	Decoupling GCB < - > MCB During decoupling there was a change over from the preferred breaker to the other.
Mns.ph.rot. mismatch	3975	Mains rotating field mismatch The mains rotating field does not correspond with the configured direction.
Mains import power 1	3217	Mains import power, limit value 1 The mains import power has exceeded or fallen below the limit value 1 for mains import power.
Mains import power 2	3218	Mains import power, limit value 2 The mains import power has exceeded or fallen below the limit value 2 for mains import power.
Mains export power 1	3241	Mains export power, limit value 1 The mains export power has exceeded or fallen below the limit value 1 for mains export power.
Mains export power 2	3242	Mains export power, limit value 2 The mains export power has exceeded or fallen below the limit value 2 for mains export power.

Message text	ID	Meaning
Mains PF lagging 1	2985	Mains power factor lagging exceeded, limit value 1 The power factor limit 1 has been exceeded at the mains interchange point towards inductive.
Mains PF lagging 2	2986	Mains power factor lagging exceeded, limit value 2 The power factor limit 2 has been exceeded at the mains interchange point towards inductive.
Mains PF leading 1	3035	Mains power factor leading exceeded, limit value 1 The power factor limit 1 has fallen below at the mains interchange point towards capacitive.
Mains PF leading 2	3036	Mains power factor leading exceeded, limit value 2 The power factor limit 1 has fallen below at the mains interchange point towards capacitive.
Mns act.pwr.mismatch	2934	Mains active power mismatch The deviation between the import/export power and the active import/export power setpoint has exceeded the limit.
Mains volt. incr.	8834	Mains voltage increase monitor has tripped The mains voltage has exceeded for a longer time period the voltage increase criteria.
QV monitoring 1	3288	QV monitoring, delay time 1 The generator reactive power has exceeded the limit with delay time 1.
QV monitoring 2	3289	QV monitoring, delay time 2 The generator reactive power has exceeded the limit with delay time 2.
Time dep. voltage 1	4958	Time-dependent voltage, limit value 1 The measured voltage falls below/exceeds the configured criteria.
Time dep. voltage 2	5022	Time-dependent voltage, limit value 2 The measured voltage falls below/exceeds the configured criteria.
Time dep. voltage 3	4980	Time-dependent voltage, limit value 3 The measured voltage falls below/exceeds the configured criteria.

9.5.5.6 Engine monitoring

Message text	ID	Meaning
Overspeed 1	2112	Engine overspeed, limit value 1 The engine speed has exceeded the limit value 1 for engine overspeed.
Overspeed 2	2113	Engine overspeed, limit value 2 The engine speed has exceeded the limit value 2 for engine overspeed.
Underspeed 1	2162	Engine underspeed, limit value 1

Message text	ID	Meaning
		The engine speed has fallen below the limit value 1 for engine underspeed.
Underspeed 2	2163	Engine underspeed, limit value 2 The engine speed has fallen below the limit value 2 for engine underspeed.
Unintended stop	2652	Unintended Stop The easYgen expects the generator to be running but a sudden underrun of the ignition speed has been detected.
Speed/freq. mismatch	2457	Difference in frequency/speed measurement The speed differential between the generator frequency (ascertained by the generator voltage measurement) and the engine speed (measured by the MPU) has exceeded the configured limit.
Eng. stop malfunct.	2504	Engine cannot be stopped There is still recognized a turning engine (by electrical frequency or speed signal) even the engine is stopped.
Start fail	3325	Failure of engine to start The generator set has failed to start after the configured number of attempts.
Charge alt. low volt	4056	Charging alternator voltage low The charging alternator voltage has fallen below the critical limit.
Cylinder temp.lev.1	14575	Cylinder temperature Level 1 The cylinder temperature difference exceeded level 1.
Cylinder temp.lev.2	14576	Cylinder temperature Level 2 The cylinder temperature difference exceeded level 2.
Cyl.tmp.wire brk.	14584	Cylinder temperature monitoring has detected sensor wire as broken
Active LS mismatch	5105	Active power loadsharing mismatch. The percentage load value of this device is different to the others.
Reactive LS mismatch	5111	Reactive power loadsharing mismatch The percentage load value of this device is different to the others.
Maint. days exceeded	2560	Maintenance days exceeded The generator run time has exceeded the configured number of days since the last maintenance call RESET.
Maint. hrs exceeded	2561	Maintenance hours exceeded The generator run time has exceeded the configured number of operating hours since the last maintenance call RESET.

9.5.5.7 Operating Range Monitoring

Message text	ID	Meaning
		Operating range monitoring alarm. The device stocks because of a logical circumstance. The operating range monitor indicates an alarm with an error

Message text	ID	Meaning
		number. The number stands for a failed check procedure. For more information refer to chapter "Operating Range Failure".
Oper.range failed 1	2665	<p>Check 1: The easYgen wants close the GCB, but the generator is not within its operating range.</p> <ul style="list-style-type: none"> • (GCB shall be closed OR Emergency run is active) AND • Firing speed is reached AND • GCB is open AND • Generator is not okay AND • Idle monitoring is expired
Oper.range failed 2	2666	<p>Check 2: The easYgen wants close the GCB, but the busbar is not within the generator operating range.</p> <ul style="list-style-type: none"> • (GCB shall be closed OR Emergency run is active) AND • Firing speed reached AND • GCB is open AND • Generator is okay AND • Busbar is undefined (Busbar not dead AND not within the operation range)
Oper.range failed 3	2667	<p>Check 3: The easYgen wants close the GCB in breaker transition mode "Open transition" with GCB and MCB open status. In this condition the busbar is expected as dead, but there is still voltage on busbar measured.</p> <ul style="list-style-type: none"> • GCB shall be closed AND • Firing speed reached AND • GCB is open AND • Breaker mode "open transition" is active AND • MCB is open AND • Busbar is okay AND • No GCB in the system is closed
Oper.range failed 4	2668	<p>Check 4: The easYgen wants close the GCB onto a dead busbar. The device cannot close the breaker onto busbar, because there is minimum one neighbor device recognized with a GCB closed.</p> <ul style="list-style-type: none"> • GCB shall be closed AND • Firing speed reached AND • GCB is open AND • Generator is okay AND • Busbar is dead AND • Minimum one GCB in the system is closed
Oper.range failed 5	2669	<p>Check 5: The easYgen wants synchronize the GCB, the MCB is closed, but the mains or busbar is not within its operating range.</p> <ul style="list-style-type: none"> • GCB shall be closed AND • Firing speed reached AND • GCB is open AND • MCB is closed AND

Message text	ID	Meaning
		<ul style="list-style-type: none"> • Idle monitoring is expired AND • Breaker mode with GGB is not active AND • Mains OR Busbar is not okay
Oper.range failed 6	2670	<p>Check 6: The easYgen wants close the GGB, but the generator minimum power is not reached.</p> <ul style="list-style-type: none"> • GGB shall be closed with deadbus closure AND • GGB request minimum power is not available AND • LM Bypass min. power for closing GGB is not active
Oper.range failed 7	2671	<p>Check 7: The easYgen wants close the GGB in the Open Transition Mode, but the generator minimum power is not reached.</p> <ul style="list-style-type: none"> • GGB shall be closed in breaker mode "open transition" AND • GGB request minimum power isn't available AND • LM Bypass min. power for closing GGB isn't active
Oper.range failed 8	2672	<p>Check 8: The easYgen wants synchronize the GGB, but the generator minimum power is not reached.</p> <ul style="list-style-type: none"> • Synchronization GGB is active AND • GGB request minimum power is not available AND • LM Bypass min. power for closing GGB is not active
Oper.range failed 9	2673	<p>Check 9: GGB control mode: The MCB or the GGB is closed with min. one neighbour GCB is closed to the busbar. There is a conflict, the external voltage monitoring of the Load Busbar signals a "Dead load busbar", which cannot be the case.</p> <p>Notice: This monitoring is not activ in operating mode STOP.</p> <ul style="list-style-type: none"> • (MCB is closed OR (GGB is closed AND min. one GCB is closed)) AND • Load busbar monitoring is active AND • Load busbar is dead AND • Breaker mode with GGB is active AND • Operation mode STOP is not active
Oper.range failed 10	2674	<p>Check 10: The easYgen wants synchronize the GGB, the MCB is closed, but the mains is not in operating range.</p> <p>Notice: This monitoring is not activ in operating mode STOP.</p> <ul style="list-style-type: none"> • Mains is not okay AND • MCB is closed AND • GCB is released AND • Breaker mode with GGB is active AND • Operation mode STOP isn't active AND • GGB is open
Oper.range failed 11	2675	<p>Check 11: The easYgen checks the plausibility of generator and busbar, if the engine runs and the GCB is closed, but the operating range of generator OR busbar is not matched.</p>

Message text	ID	Meaning
		<p>Notice: This monitoring is not activ in run-up synchronization mode.</p> <ul style="list-style-type: none"> • (Busbar is not okay OR Generator is not okay OR Phase angle difference is > 12°) AND • GCB is closed AND • Run-up synchronization is not active AND • Engine is released
Oper.range failed 12	2676	<p>Check 12: The easYgen checks the phase rotation of generator, busbar and mains. If the phase rotation of all systems does not match and a synchronisation shall be executed this will occur. (Synchronisation is blocked)</p> <ul style="list-style-type: none"> • Synchronisation (GCB, GGB or MCB) shall be executed AND • Phase rotation of all systems does not match

9.5.5.8 Breaker Monitoring

Message text	ID	Meaning
GCB fail to close	2603	<p>GCB failed to close</p> <p>The easYgen has attempted to close the GCB the configured maximum number of attempts and failed.</p>
GCB fail to open	2604	<p>GCB failed to open</p> <p>The easYgen has attempted to open the GCB within the configured time and failed.</p>
GCB syn. timeout	3064	<p>GCB synchronization time exceeded</p> <p>The easYgen has failed to synchronize the GCB within the configured synchronization time.</p>
GCB failure 50BF	10668	<p>GCB failure 50BF</p> <p>Generator current is measured even if the mains reply signals GCB open.</p>
GGB fail to open	3090	<p>Failed GGB open</p> <p>The easYgen is still receiving the reply "GGB closed" after the GGB open monitoring timer has expired.</p>
GGB fail to close	3089	<p>Failed GGB close</p> <p>The easYgen is still receiving the reply "GGB opened" after the configured maximum number of close attempts and failed.</p>
Timeout syn. GGB	3084	<p>GGB synchronization time exceeded</p> <p>The easYgen has failed to synchronize the GGB within the configured synchronization time.</p>
MCB fail to close	2623	<p>MCB failed to close</p> <p>The easYgen has attempted to close the MCB the configured maximum number of attempts and failed. Depending on the configuration, the easYgen will continue to attempt to close the GCB as long as the conditions for closing the MCB are fulfilled.</p>
MCB fail to open	2624	<p>Failed MCB open</p>

Message text	ID	Meaning
		The easYgen is still receiving the reply MCB closed" after the MCB open monitoring timer has expired.
MCB syn. timeout	3074	MCB synchronization time exceeded The easYgen has failed to synchronize the MCB within the configured synchronization time.
MCB failure 50BF	10670	MCB failure 50BF There is a mains current measured even the MCB reply signals MCB open.
MCB plausibility	10672	MCB plausibility The number of closed MCBs is different to the number of easYgen and/or easY-I devices in the same segment.
N-cont. reply mism.	5153	Neutral contactor reply mismatch Neutral contactor reply mismatch to the NC command.

9.5.5.9 CANopen Monitoring

Message text	ID	Meaning
CANopen Interface 1	10087	Interface alarm CANopen on CAN bus 1 No Receive Process Data Object (RPDO) is received within the configured time.
CANopen Interface 2	10088	Interface alarm CANopen on CAN bus 2 There is a timeout on at least one expansion board that is configured as available.
CANopen Interface 3	10090	Interface alarm CANopen on CAN bus 3 No Receive Process Data Object (RPDO) is received within the configured time.

9.5.5.10 CAN J1939 (ECU) Monitoring

Message text	ID	Meaning
J1939 dev. 1 timeout	10059	J1939 device 1 timeout Messages from the J1939 device 1 are missing. (CAN2)
J1939 dev. 2 timeout	10091	J1939 device 2 timeout Messages from the J1939 device 2 are missing. (CAN2)
J1939 dev. 3 timeout	10092	J1939 device 3 timeout Messages from the J1939 device 3 are missing. (CAN2)
J1939 ECU timeout	10058	J1939 ECU timeout Messages from the J1939 ECU are missing. (CAN2)
J1939 AVR timeout	10009	J1939 AVR timeout

Message text	ID	Meaning
		Messages from the J1939 AVR are missing or remote configuration of the AVR (e.g. Exciter-10-P2) does not work. (CAN2)
Red stop lamp	15125	Red stop lamp, J1939 interface The ECU sends a red stop lamp signal. There is a critical failure detected in the ECU.
Amber warning lamp	15126	Amber warning lamp, J1939 interface The ECU sends a amber warning lamp signal. There is a warning failure detected in the ECU.
J1939 Emission lamp	10663	J1939 Emission lamp ECU has an Emission/Malfunction alarm.
J1939 Protect lamp	10662	J1939 Protect lamp ECU has a protect alarm.

9.5.5.11 Ethernet Communication Monitoring

Message text	ID	Meaning
Ethernet issue	11852	Abnormal rate of Ethernet messages. The device detects an abnormal high rate of Ethernet UDP-messages per time scale.
Eth. configuration	15055	Wrong configuration of Ethernet network address performed.

9.5.5.12 Multi-unit Monitoring

Message text	ID	Meaning
Parameter alignment	4073	LDSS parameter mismatch detected The easYgen has detected that not all LDSS parameters are configured identically at all participating units. Refer in the manual to the chapter "Multi-unit Parameter Alignment" to see the relevant LDSS parameter.
Missing easYgen	4059	Missing easYgen At least one easYgen or easY-I is missing. Check the status of the communication diagnostic.
Missing LSx	4069	Missing LSx device in layer 1 region At least one LSx device in layer 1 region is missing. Check the status of the communication diagnostic.
Syst.update easYgen	4074	System update easYgen The communication topology of easYgens and/or easY-I have changed. Check the communication easYgen and/or easY-I.
Syst.update LSx	4075	System update LSx device

Message text	ID	Meaning
		The communication topology of LSx devices have changed. Check the communication LSx devices.
Syst.update Layer1	4197	System update Layer 1 The communication topology within of communication Layer 1 has changed. Check the communication easYgen and/or easY-I respectively LSx devices in Layer 1.
EthB EthC redundancy	2430	The Load share interface Ethernet B / Ethernet C redundancy is lost. The device warns that the Ethernet redundancy B/C is lost. Check the communication diagnostic screen of the according layer.
CAN EthA redundancy	2439	The Load share interface CAN / Ethernet A redundancy is lost. The device warns that the Ethernet redundancy CAN/EthA is lost. Check the communication diagnostic screen of the layer 1.

9.5.5.13 Flexible Limits Monitoring

Message text	ID	Meaning
		40 flexible limits. This text may be assigned customer defined. The Indication here is the default text.
Flexible limit 1	10018	
Flexible limit 2	10019	
Flexible limit 3	10020	
Flexible limit 4	10021	
Flexible limit 5	10022	
Flexible limit 6	10023	
Flexible limit 7	10024	
Flexible limit 8	10025	
Flexible limit 9	10026	
Flexible limit 10	10027	
Flexible limit 11	10028	
Flexible limit 12	10029	
Flexible limit 13	10030	
Flexible limit 14	10031	
Flexible limit 15	10032	
Flexible limit 16	10033	
Flexible limit 17	10034	
Flexible limit 18	10035	
Flexible limit 19	10036	
Flexible limit 20	10037	
Flexible limit 21	10038	
Flexible limit 22	10039	

Message text	ID	Meaning
Flexible limit 23	10040	
Flexible limit 24	10041	
Flexible limit 25	10042	
Flexible limit 26	10043	
Flexible limit 27	10044	
Flexible limit 28	10045	
Flexible limit 29	10046	
Flexible limit 30	10047	
Flexible limit 31	10048	
Flexible limit 32	10049	
Flexible limit 33	10050	
Flexible limit 34	10051	
Flexible limit 35	10052	
Flexible limit 36	10053	
Flexible limit 37	10054	
Flexible limit 38	10055	
Flexible limit 39	10056	
Flexible limit 40	10057	

9.5.5.14 Digital Inputs Monitoring

Message text	ID	Meaning
		Discrete input 1-23, energized / de-energized The actual state of the monitored discrete input is energized / de-energized (depending on the configuration) for at least the configured time. This text may be assigned customer defined. The Indication here is the default text.
Discrete input 1	10600	
Discrete input 2	10601	
Discrete input 3	10602	
Discrete input 4	10603	
Discrete input 5	10604	
Discrete input 6	10605	
Discrete input 7	10607	
Discrete input 8	10608	
Discrete input 9	10609	
Discrete input 10	10610	
Discrete input 11	10611	
Discrete input 12	10612	

Message text	ID	Meaning
Discrete input 13	10613	
Discrete input 14	10614	
Discrete input 15	10615	
Discrete input 16	10616	
Discrete input 17	10617	
Discrete input 18	10618	
Discrete input 19	10619	
Discrete input 20	10620	
Discrete input 21	10621	
Discrete input 22	10622	
Discrete input 23	10623	

9.5.5.15 External Digital Inputs Monitoring

Message text	ID	Meaning
		External discrete input 1-32, energized / de-energized The actual state of the monitored discrete input is energized / de-energized (depending on the configuration) for at least the configured time. This text may be assigned customer defined. The Indication here is the default text.
Ext. Discrete input 1	16360	
Ext. Discrete input 2	16361	
Ext. Discrete input 3	16362	
Ext. Discrete input 4	16364	
Ext. Discrete input 5	16365	
Ext. Discrete input 6	16366	
Ext. Discrete input 7	16367	
Ext. Discrete input 8	16368	
Ext. Discrete input 9	16369	
Ext. Discrete input 10	16370	
Ext. Discrete input 11	16371	
Ext. Discrete input 12	16372	
Ext. Discrete input 13	16373	
Ext. Discrete input 14	16374	
Ext. Discrete input 15	16375	
Ext. Discrete input 16	16376	
Ext. Discrete input 17	16202	
Ext. Discrete input 18	16212	
Ext. Discrete input 19	16222	

Message text	ID	Meaning
Ext. Discrete input 20	16232	
Ext. Discrete input 21	16242	
Ext. Discrete input 22	16252	
Ext. Discrete input 23	16262	
Ext. Discrete input 24	16272	
Ext. Discrete input 25	16282	
Ext. Discrete input 26	16292	
Ext. Discrete input 27	16302	
Ext. Discrete input 28	16312	
Ext. Discrete input 29	16322	
Ext. Discrete input 30	16332	
Ext. Discrete input 31	16342	
Ext. Discrete input 32	16352	

9.5.5.16 Wire Break Monitoring (of internal and external analog inputs)

Message text	ID	Meaning
		<p>Wb: Analog input 1-10, wire break (internal analog inputs)</p> <p>Wb: External Analog input 1-16, wire break (external analog inputs)</p> <p>During the measurement of the analog input a wire break was detected. The text begins with Wb: for wire break. The second part of the text may be assigned customer defined. The Indication here is the default text.</p>
Wb:Analog input 1	10014	
Wb:Analog input 2	10015	
Wb:Analog input 3	10060	
Wb:Analog input 4	10061	
Wb:Analog input 5	10062	
Wb:Analog input 6	10063	
Wb:Analog input 7	10064	
Wb:Analog input 8	10065	
Wb:Analog input 9	10066	
Wb:Analog input 10	10067	
Wb:External Analog input 1	10221	
Wb:External Analog input 2	10222	
Wb:External Analog input 3	10223	
Wb:External Analog input 4	10224	

Message text	ID	Meaning
Wb:External Analog input 5	10225	
Wb:External Analog input 6	10226	
Wb:External Analog input 7	10227	
Wb:External Analog input 8	10228	
Wb:External Analog input 9	10229	
Wb:External Analog input 10	10230	
Wb:External Analog input 11	10231	
Wb:External Analog input 12	10232	
Wb:External Analog input 13	10233	
Wb:External Analog input 14	10234	
Wb:External Analog input 15	10235	
Wb:External Analog input 16	10236	

9.5.5.17 Free Configurable Alarms

Message text	ID	Meaning
		16 free configurable Alarms. The alarm text is configurable. The indication here is the default text.
Free alarm 1	8120	
Free alarm 2	8124	
Free alarm 3	8128	
Free alarm 4	8132	
Free alarm 5	8136	
Free alarm 6	8140	
Free alarm 7	8144	
Free alarm 8	8148	
Free alarm 9	8154	
Free alarm 10	8158	
Free alarm 11	8165	
Free alarm 12	8170	
Free alarm 13	8174	
Free alarm 14	8178	

Message text	ID	Meaning
Free alarm 15	8182	
Free alarm 16	8186	
Free alarm 17	1402	
Free alarm 18	1412	
Free alarm 19	1422	
Free alarm 20	1432	
Free alarm 21	1442	
Free alarm 22	1452	
Free alarm 23	1462	
Free alarm 24	1472	
Free alarm 25	8104	
Free alarm 26	8112	
Free alarm 27	8191	
Free alarm 28	8217	
Free alarm 29	8225	
Free alarm 30	8279	
Free alarm 31	8287	
Free alarm 32	8381	

9.5.5.18 Miscellaneous Monitoring

Message text	ID	Meaning
Bat. overvoltage 1	10007	Battery overvoltage, limit value 1 The battery voltage has exceeded the limit value 1 for battery overvoltage.
Bat. overvoltage 2	10008	Battery overvoltage, limit value 2 The battery voltage has exceeded the limit value 2 for battery overvoltage.
Bat. undervoltage 1	10005	Battery undervoltage, limit value 1 The battery voltage has fallen below the limit value 1 for battery undervoltage.
Bat. undervoltage 2	10006	Battery undervoltage, limit value 2 The battery voltage has fallen below the limit value 2 for battery undervoltage.
Gen. AC wiring	10093	AC wiring issue of Generator voltages One or more of the generator voltages are wrong wired (detected by plausibility checking of frequencies).
Busbar 1 AC wiring	10094	AC wiring issue of Busbar voltages One or more of the busbar voltages are wrong wired (detected by plausibility checking of frequencies).
Mains AC wiring	10095	AC wiring issue of Mains voltages

Message text	ID	Meaning
		One or more of the mains voltages are wrong wired (detected by plausibility checking of frequencies).
PV disconnect level	8927	The PV source level drives generator into revers power. The generator power has reached a reverse power with a critical rate. The PV source penetration is interrupted.
GC common alarm	11849	Common Group Controller alarm A "GC common alarm" is reported from the connected GC. Check the GC.
CPU overload R1 trip	14799	A CPU overload has occurred. With the CPU overload the self-test relais R1 was tripped.
Meas.difference 4105	5141	Measurement difference 4105 The own 4105 relevant mains measurement is different to the 4105 partner.
Missing member 4105	5129	Missing 4105 diagnostic partner The easYgen finds no partner anymore to do 4105 diagnostic.
Para.alignment 4105	5135	Parameter alignment 4105 failure The own 4105 relevant parameter are different to the 4105 partner.

9.6 Formulas

9.6.1 Conversion Factors

Temperature

°C → °F	$T [^{\circ}\text{F}] = (T [^{\circ}\text{C}] \times 1.8) + 32$
°F → °C	$T [^{\circ}\text{C}] = (T [^{\circ}\text{F}] - 32) / 1.8$

Pressure

bar → psi	$P [\text{psi}] = P [\text{bar}] \times 14.503$
psi → bar	$P [\text{bar}] = P [\text{psi}] / 14.503$

9.6.2 Load Dependent Start Stop (LDSS) Formulas

The following formulas are used by the load-dependent start/stop function to determine whether a genset is to be started or stopped.

Abbreviations

Abbreviation	Parameter	
PGN _{real active}		Momentary active generator real power on the busbar

Abbreviation	Parameter	
P _{rated active}		Momentary active generator rated power on the busbar
Preserve		P _{rated active} - P _{GN real active}
P _{reserve islanded}	5760	Minimum permissible reserve power on busbar in islanded operation
P _{hysteresis IOP}	5761	hysteresis in islanded operation
PMN _{setpoint}		Export / import power control setpoint
PMN _{real}		Momentary active power at the interchange point
PMOP _{minimum}	5767	Minimum requested generator load
P _{reserve parallel}	5768	Minimum permissible reserve power on busbar in mains parallel operation
P _{hysteresis MOP}	5769	P _{hysteresis} in mains parallel operation
P _{max. load islanded}	5762	Maximum permissible generator load in islanded operation
P _{min. load islanded}	5763	Minimum permissible generator load in islanded operation
P _{max. load parallel}	5770	Maximum permissible generator load in mains parallel operation
P _{min. load parallel}	5771	Minimum permissible generator load in mains parallel operation

LDSS mode "Reserve Power"

Task	Formula
Islanded Operation	
Changing the Engine Combination to Increase Rated Power	$PGN_{real\ active} + P_{reserve\ islanded} > P_{rated\ active}$
Changing the Engine Combination to Reduce Rated Power	$PGN_{real\ active} + P_{reserve\ islanded} + P_{hysteresis\ IOP} < P_{rated\ active}$
Mains Parallel Operation (Import/Export Control)	
Starting the First Engine Combination (no engine supplies the busbar)	$PMN_{setpoint} - PMN_{real} + PGN_{real\ active} > PMOP_{minimum}$
Changing the Engine Combination to Increase Rated Power	$PMN_{setpoint} - PMN_{real} + PGN_{real\ active} + P_{reserve\ parallel} > P_{rated\ active}$
Changing the Engine Combination to Reduce Rated Power	$PMN_{setpoint} - PMN_{real} + PGN_{real\ active} + P_{reserve\ parallel} + P_{hysteresis\ MOP} < P_{rated\ active}$
Stopping the Last Engine Combination (load close to minimum load)	$PMN_{setpoint} - PMN_{real} + PGN_{real\ active} < PMOP_{minimum} - P_{hysteresis\ MOP}$

LDSS mode "Generator Load"

Task	Formula
Islanded Operation	
Changing the Engine Combination to Increase Rated Power	$PGN_{real\ active} > P_{max.\ load\ islanded}$
Changing the Engine Combination to Reduce Rated Power (except dynamic setpoint is not matched)	$PGN_{real\ active} < P_{min.\ load\ islanded}$
Mains Parallel Operation (Import/Export Control)	
Starting the First Engine Combination	$PMN_{setpoint} - PMN_{real} + PGN_{real\ active} > PMOP_{minimum}$

Task	Formula
(no engine supplies the busbar)	
Changing the Engine Combination to Increase Rated Power	$PGN_{\text{real active}} > P_{\text{max. load parallel}}$
Changing the Engine Combination to Reduce Rated Power (except dynamic setpoint is not matched)	$PGN_{\text{real active}} < P_{\text{min. load parallel}}$
Stopping the Last Engine Combination (load close to minimum load)	$PMN_{\text{setpoint}} - PMN_{\text{real}} + PGN_{\text{real active}} < PMOP_{\text{minimum}} - P_{\text{hysteresis MOP}}$

LDSS dynamic

Dynamic characteristic	$= [(\text{max. generator load} - \text{min. generator load}) * \text{dynamic}] + (\text{min. generator load})$	
Dynamic power level	$= (\text{dynamic characteristic}) * (\text{generator rated power})$	
Constants	Low dynamic	$= 25 \%$
	Moderate dynamic	$= 50 \%$
	High dynamic	$= 75 \%$

✱

Example for moderate dynamic

- Dynamic characteristic = $[(80 \% - 40 \%) * 50 \%) + (40 \%) = 60 \%$
- Dynamic power level = $(60 \%) * (200 \text{ kW}) = 120 \text{ kW}$

10 List Of Abbreviations

AC	Alternating current
AI	Analog input
AM	AnalogManager
AO	Analog output
AVR	Automatic voltage regulator
BDEW	German community of 1,800 companies represented by the German Association of Energy and Water Industries (Bundesverband der Energie- und Wasserwirtschaft)
BMS	Battery management system
CB	Circuit Breaker
CCW	Counter clock wise
CL	Code Level
COB-ID	Communication Object Identifier (CAN)
CT	Current Transformer
CW	Clock wise
DBCL	Dead bus closure
DI	Discrete Input
DO	Discrete (Relay) Output
DEF	Diesel exhaust fluid
DPF	Diesel Particulate Filter
ECU	Engine Control Unit
EG	Name of device 'easYgen'
EIO	Emergency inducement override
EX-10	Woodward excitation module "easYgen exciter 10"
FMI	Failure Mode Indicator (J1939)
FRT	Fault ride through
GAP	Graphical Application Programmer (GAP™)
GC	Name of device 'Group Controller'
GCB	Generator Circuit Breaker
GCP	Woodward device series (Genset Control) - not preferred for new design!
GGB	Generator Group Breaker
GOV	(speed) Governor; rpm regulator

Hc	Hydrocarbon
HMI	Human Machine Interface e.g., a front panel with display and buttons for interaction
I	Current
IOP	Island Operation
LDSS	Load-Dependent Start/Stop operation
LM	LogicsManager©
LS	Load share
LSG	Woodward device: Load Share Gateway (communication converter)
LS5	Name of a device LS-5
LSx	Name of a device LS-5 or LS-6XT
MCB	Mains Circuit Breaker
MFR	Woodward device series (multifunctional relays) - not preferred for new design!
MOP	Mains Operation in Parallel
MPU	Magnetic Pickup Unit
MS	Mobile systems
N.C.	Normally Closed (break) contact
N.O.	Normally Open (make) contact
NC	Neutral Contactor
NOx	Nitrogen oxide
NW	Network
OC	Occurrence Count
P	Active power
P/N	Part Number
PDO	Process Data Object (CAN)
PF	Power Factor
PGN	Parameter Group Number (J1939)
PID	Proportional and Integral and Differential
PLC	Programmable Logic Control
PT	Potential (Voltage) Transformer
PV	Photovoltaic
Q	Reactive power
S	Apparent power

SAE	Society of Automotive Engineers (defines J1939 CAN protocol standard)
SCR	Selective Catalytic Reduction
SDO	Service Data Object (CAN)
S/N	Serial Number
SNTP	Simple Network Time Protocol
SOC	State of charge
SOH	State of health
SP	Setpoint
SPN	Suspect Parameter Number (J1939)
V	Voltage
va	Unit of apparent power (S). Often also as kva
var	Unit of reactive power (Q). Often also as kvar
W	Unit of active power (P). Often also as kW
Wb	Wire break

Index

A

Alarms	629
Free configurable	631
AnalogManager sample	762, 763

B

BDEW	570
Battery	
Monitoring	652, 653
Busbar	
Phase Rotation	535

C

CAN	
J1939 Interface	639
Monitoring	633, 635, 637
Contact person	45
Critical Mode	453
Cust. Buttons	
customize	59
Customer Service	45

D

Data Identifiers	1257
Droop	400

E

Engine	
Overspeed	540
Shutdown Malfunction	546
Speed Detection	543

Start Failure	545
Underspeed	541
Unintended Stop	547
Engine/Generator	
Active Power Mismatch	522
Unloading Mismatch	523
Engine/Mains	
Active Power Mismatch	605
Ethernet	
Monitoring	651
F	
Front Panel	53
G	
GCB	611
Application	321
Synchronization	614
GCB 50BF	613
GGB	615
Application	329
GGB Handling	314
Generator	
Ground Fault	529
Inverse Time-Overcurrent	504
Lagging Power Factor	524
Overfrequency	498
Overvoltage	492
Phase Rotation	533
Pole Slip Monitoring	537
Reverse/Reduced Power	514
Speed Detection	543
Unbalanced Load	516

Underfrequency	500
Undervoltage	493
Voltage asymmetry	495
Grid Code	570
Group Controller (GC)	815
H	
HMI	52
Translation Tool	194
Home Screen	58, 148
I	
IOP	471
Intended use	50
Interconnectivity	746, 836
islanded Parallel Operation	471
J	
J1939 Interface	639, 645, 646, 647, 648
L	
LDSS	460
Layer	815
Load Control	413
Load Dependent Start Stop	460
Load Share Control	388
Localization Tool (for customized language)	194
M	
MCB	617
Application	334
MOP	477
Mains	

Blocking protection	557
Change Of Frequency	595
Decoupling	561
Export Power	604
General Mains Operating Range	558
Import Power	602
Lagging Power Factor	607
Leading Power Factor	609
QV Monitoring	592
Reconnecting Mains Operating Range	560
Time-Dependent Voltage	581
Underfrequency	573
Undervoltage	577
Voltage Increase	579
Voltage Phase Rotation	600
Mains Parallel Operation	477
Measurement	
Parameters	665
Modbus	
Master	987
Modbus Protocol	684
Telegram Mapper	985
O	
Operating Range Failure	662
P	
PID Control	434
PV Photovoltaic	
Configuration	439
Monitoring load reference	655
Personnel	45
Power Factor Control	362

Reactive Power Q(P)	382
Reactive Power Q(V)	378
Protective equipment	50
S	
Service	45
Symbols	
in the instructions	43
System Update	825
Diagnostic Screens	827
Monitoring	661
T	
Temperature	
Cylinder Temperature	549
ToolKit	187
U	
Use	50
V	
VDE-AR-N 4105	565
Voltage Control	347
AVR	354
W	
Warranty	45



Woodward GmbH

Handwerkstraße 29 — 70565 Stuttgart — Germany

Phone +49 (0) 711 789 54-510

Fax +49 (0) 711 789 54-101

marketing_pg@woodward.com